



Schottky Barrier Diode

Qualified per MIL-PRF-19500/444

Qualified Levels:
JAN, JANTX, and
JANTXV

DESCRIPTION

This Schottky barrier diode is metallurgically bonded and offers military grade qualifications for high-reliability applications on "1N" prefixed numbers. This small diode is hermetically sealed and bonded into a DO-35 glass package.

Important: For the latest information, visit our website <http://www.microsemi.com>.

FEATURES

- JEDEC registered 1N5711-1, 1N5712-1, 1N6857-1, and 1N6858-1 numbers.
- Metallurgically bonded.
- JAN, JANTX, JANTXV and commercial qualifications also available per MIL-PRF-19500/444 on "1N" numbers only.
(See [Part Nomenclature](#) for all available options).
- RoHS compliant versions available (commercial grade only).

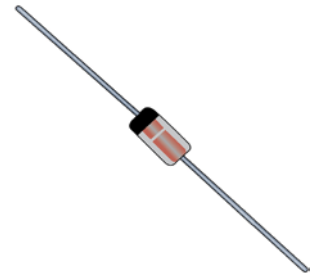
APPLICATIONS / BENEFITS

- Low reverse leakage characteristics.
- Small size for high density mounting using flexible thru-hole leads (see package illustration).
- ESD sensitive to Class 1.

MAXIMUM RATINGS @ 25 °C unless otherwise stated


Parameters/Test Conditions	Symbol	Value	Unit
Junction and Storage Temperature	T _J and T _{STG}	-65 to +150	°C
Thermal Resistance, Junction-to-Lead @ lead length = 0.375 inch (9.52 mm) from body	R _{θJL}	250	°C/W
Average Rectified Output Current:	I _O	33	mA
1N5711 ⁽¹⁾		75	
DSB2810, DSB5712, 1N5712 & 1N6858 ⁽²⁾ 1N6857 ⁽³⁾		150	
Solder Temperature @ 10 s		260	°C


- NOTES:**
1. At T_L = +130°C and L = 0.375 inch, derate I_O to 0 at +150°C.
 2. At T_L = +110°C and L = 0.375 inch, derate I_O to 0 at +150°C.
 3. At T_L = +70°C and L = 0.375 inch, derate I_O to 0 at +150°C.



**DO-35 (DO-204AH)
Package**

Also available in:

 **UB package**
(3-pin surface mount)
[1N5711UB](#), [1N5712UB](#)
([B](#), [CC](#), [CA](#))

 **DO-213AA package**
(surface mount)
[1N5711UR-1](#), [1N5712UR-1](#),
[1N6857UR-1](#), and
[1N6858UR-1](#)

MSC – Lawrence

6 Lake Street,
Lawrence, MA 01841
Tel: 1-800-446-1158 or
(978) 620-2600
Fax: (978) 689-0803

MSC – Ireland

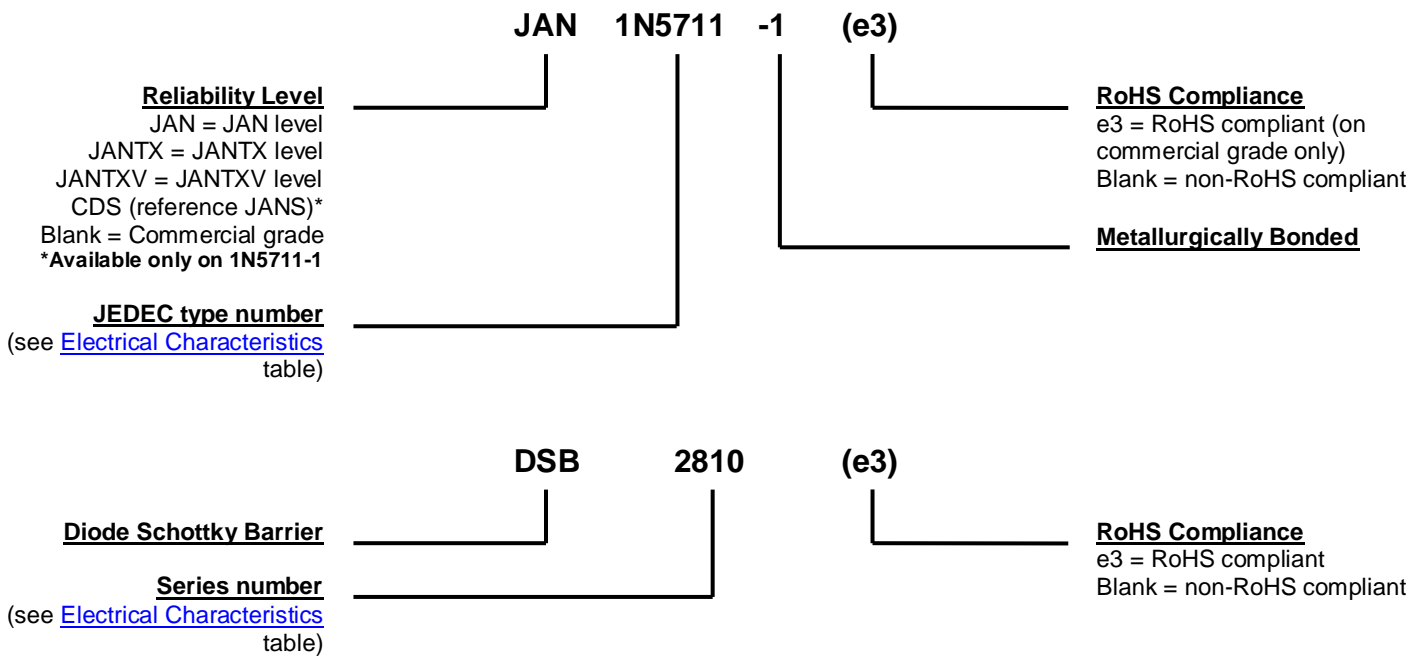
Gort Road Business Park,
Ennis, Co. Clare, Ireland
Tel: +353 (0) 65 6840044
Fax: +353 (0) 65 6822298

Website:

www.microsemi.com

MECHANICAL and PACKAGING

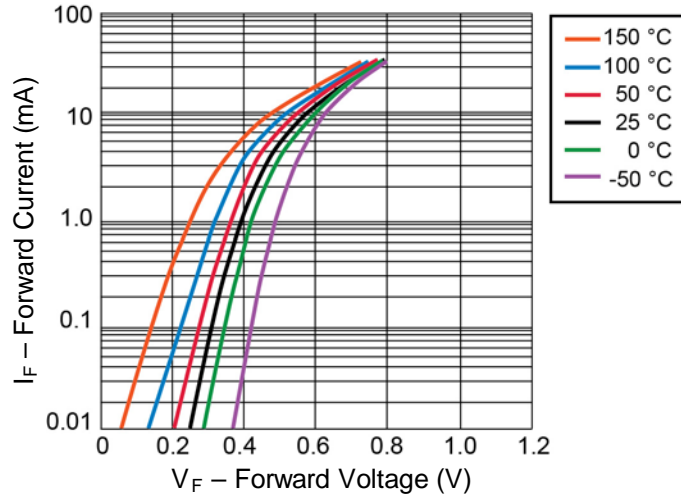
- CASE: Hermetically sealed glass package.
- TERMINALS: Tin/lead plated or RoHS compliant matte-tin (on commercial grade only) over copper clad steel. Solderable per MIL-STD-750, method 2026.
- POLARITY: Cathode indicated by band.
- MARKING: Part number.
- TAPE & REEL option: Standard per EIA-296. Consult factory for quantities.
- WEIGHT: Approximately 0.2 grams.
- See [Package Dimensions](#) on last page.

PART NOMENCLATURE

SYMBOLS & DEFINITIONS

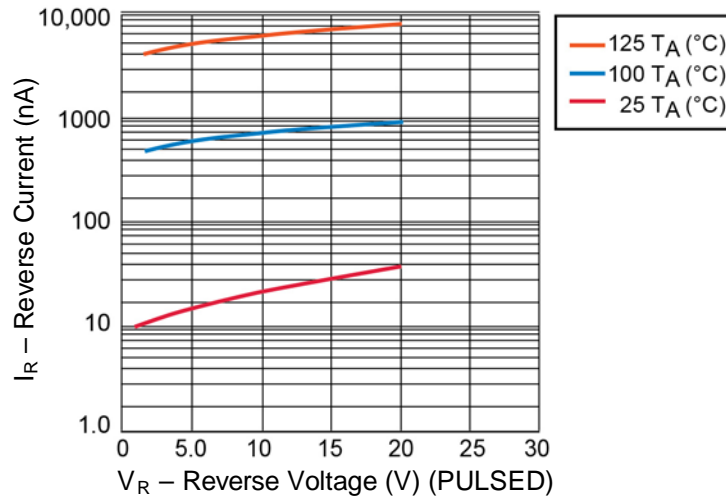
Symbol	Definition
C	Capacitance: The capacitance in pF at a frequency of 1 MHz and specified voltage.
f	frequency
I_R	Reverse Current: The dc current flowing from the external circuit into the cathode terminal at the specified voltage V_R .
I_o	Average Rectified Output Current: The Output Current averaged over a full cycle with a 50 Hz or 60 Hz sine-wave input and a 180 degree conduction angle.
t_{rr}	Reverse Recovery Time: The time interval between the instant the current passes through zero when changing from the forward direction to the reverse direction and a specified decay point after a peak reverse current occurs.
$V_{(BR)}$	Breakdown Voltage: A voltage in the breakdown region.
V_F	Forward Voltage: A positive dc anode-cathode voltage the device will exhibit at a specified forward current.
V_R	Reverse Voltage: A positive dc cathode-anode voltage below the breakdown region.
V_{RWM}	Working Peak Reverse Voltage: The peak voltage excluding all transient voltages (ref JEESD282-B). Also sometimes known historically as PIV.

ELECTRICAL CHARACTERISTICS @ 25 °C unless otherwise noted

TYPE NUMBER	MINIMUM BREAKDOWN VOLTAGE	MAXIMUM FORWARD VOLTAGE	MAXIMUM FORWARD VOLTAGE	WORKING PEAK REVERSE VOLTAGE	MAXIMUM REVERSE LEAKAGE CURRENT		MAXIMUM CAPACITANCE @ $V_R = 0$ VOLTS $f = 1.0$ MHz
	$V_{(BR)}$ @ 10 μ A	V_F @ 1 mA	V_F @ I_F	V_{RWM}	I_R @ V_R		C
	Volts	Volts	V @ mA	V (pk)	nA	Volts	pF
1N5711-1	70	0.41	1.0 @ 15	50	200	50	2.0
1N5712-1	20	0.41	1.0 @ 35	16	150	16	2.0
1N6857-1	20	0.35	0.75 @ 35	16	150	16	4.5
1N6858-1	70	0.36	0.65 @ 15	50	200	50	4.5
DSB2810	20	0.41	1.0 @ 35	16	100	15	2.0
DSB5712	20	0.41	1.0 @ 35	16	150	16	2.0

GRAPHS

FIGURE 1

I-V Curve showing typical Forward Voltage Variation Temperature for the 1N5712-1, DSB5712 and DSB2810 Schottky Diodes


FIGURE 2

1N5712-1, DSB5712 and DSB2810 Typical variation of Reverse Current (I_R) vs Reverse Voltage (V_R) at Various Temperatures

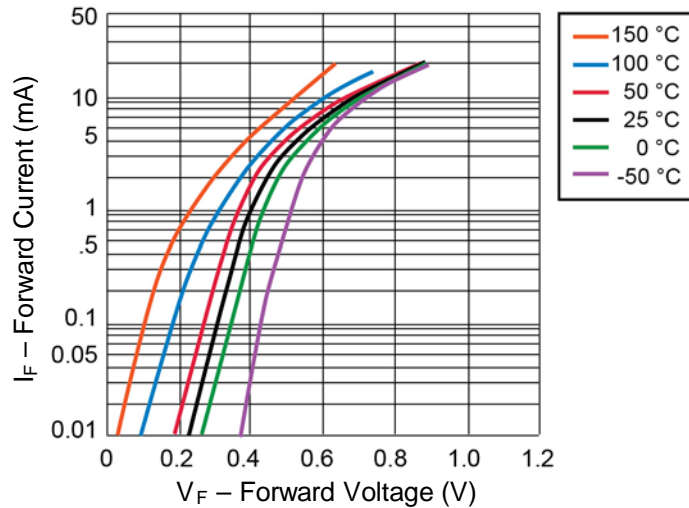
GRAPHS


FIGURE 3
I – V curve showing typical Forward Voltage Variation
With Temperature Schottky Diode 1N5711

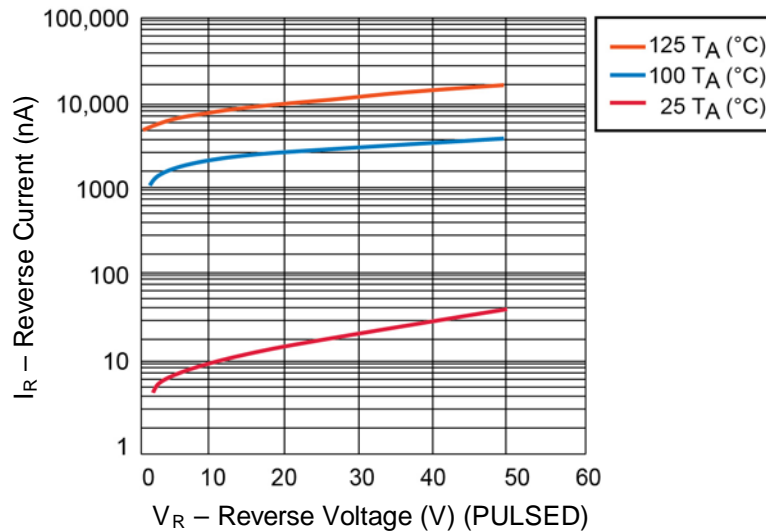


FIGURE 4
1N5711 Typical Variation of Reverse Current (I_R) vs Reverse Voltage (V_R)
at Various Temperatures

GRAPHS

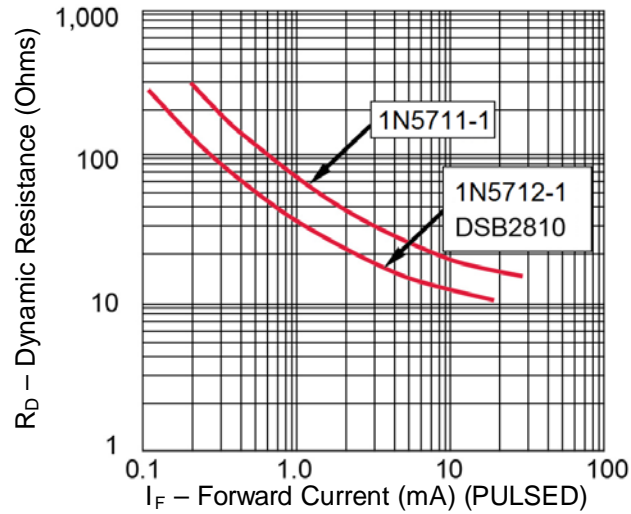
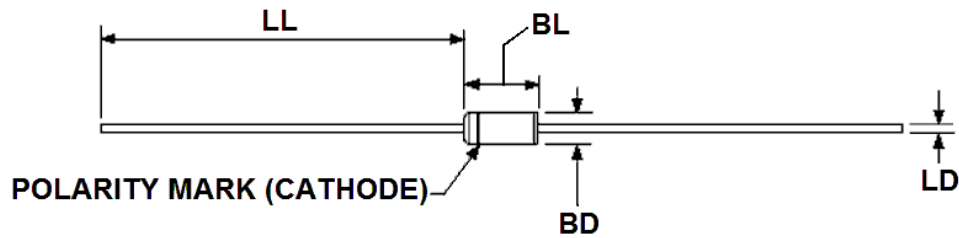


FIGURE 5
Typical Dynamic Resistance (R_D) vs Forward Current (I_F)

PACKAGE DIMENSIONS

NOTES:

1. Dimensions are in inches. Millimeters are given for information only.
2. Dimensions BL and LD includes all components of the diode periphery expect the section of the leads over which the diameter is controlled.
3. Dimension BD shall be measured at the largest diameter.
4. In accordance with ASME Y1.4M, diameters are equivalents to ϕ x symbology.

Symbol	Dimensions				Notes
	Inches		Millimeters		
	Min	Max	Min	Max	
BD	0.068	0.076	1.73	1.93	2,3
BL	0.125	0.170	3.18	4.32	2
LD	0.014	0.022	0.36	0.56	
LL	1.000	1.500	25.40	38.10	

Mouser Electronics

Authorized Distributor

Click to View Pricing, Inventory, Delivery & Lifecycle Information:

Microchip:

[1N5712](#) [1N5712-1](#) [1N6857-1](#) [1N6858UR-1](#) [1N6858-1](#) [1N6857UR-1](#) [CDLL2810/TR](#) [JANTX1N5712-1/TR](#) [1N6858-1/TR](#) [JANTXV1N5711-1/TR](#) [JAN1N5712-1/TR](#) [CDLL2810e3/TR](#) [CDLL2810e3](#) [JAN1N5711-1/TR](#) [1N6857-1/TR](#) [1N5712/TR](#) [1N5712-1/TR](#) [1N5712-1E3](#) [1N5711e3](#) [1N5712-1E3/TR](#) [1N5711e3/TR](#) [1N5711/TR](#) [1N5711-1/TR](#)

Данный компонент на территории Российской Федерации

Вы можете приобрести в компании MosChip.

Для оперативного оформления запроса Вам необходимо перейти по данной ссылке:

<http://moschip.ru/get-element>

Вы можете разместить у нас заказ для любого Вашего проекта, будь то серийное производство или разработка единичного прибора.

В нашем ассортименте представлены ведущие мировые производители активных и пассивных электронных компонентов.

Нашей специализацией является поставка электронной компонентной базы двойного назначения, продукции таких производителей как XILINX, Intel (ex.ALTERA), Vicor, Microchip, Texas Instruments, Analog Devices, Mini-Circuits, Amphenol, Glenair.

Сотрудничество с глобальными дистрибьюторами электронных компонентов, предоставляет возможность заказывать и получать с международных складов практически любой перечень компонентов в оптимальные для Вас сроки.

На всех этапах разработки и производства наши партнеры могут получить квалифицированную поддержку опытных инженеров.

Система менеджмента качества компании отвечает требованиям в соответствии с ГОСТ Р ИСО 9001, ГОСТ РВ 0015-002 и ЭС РД 009

Офис по работе с юридическими лицами:

105318, г.Москва, ул.Щербаковская д.3, офис 1107, 1118, ДЦ «Щербаковский»

Телефон: +7 495 668-12-70 (многоканальный)

Факс: +7 495 668-12-70 (доб.304)

E-mail: info@moschip.ru

Skype отдела продаж:

moschip.ru

moschip.ru_4

moschip.ru_6

moschip.ru_9