

# Solid State Sensors

## Closed Loop Current Sensors

CSN Series



### FEATURES

- Current sensing up to 1200 amps
- Measures AC, DC and impulse currents
- Lowest cost/performance ratio
- Rapid response, no overshoot
- High overload capacity
- High level of electrical isolation between primary and secondary circuits
- Small size and weight

### CLOSED LOOP SENSORS

Closed loop current sensors measure AC, DC and impulse currents over 0-25, 0-50, 0-100, 0-600 and 0-1200 Amp ranges. The CSN Series is based on the principles of the Hall effect and the null balance or zero magnetic flux method (feedback system). The magnetic flux in the sensor core is constantly controlled at zero. The amount of current required to balance zero flux is the measure of the primary current flowing through the conductor, multiplied by the ratio of the primary to secondary windings. This closed loop current is the output from the device and presents an image of the primary current reduced by the number of secondary turns at any time. This current can be expressed as a voltage by passing it through a resistor.

### CATALOG NUMBER SYSTEM

PLEASE NOTE: This matrix is intended **only** to aid you in identifying sensor catalog listings. It is not all-inclusive, and **must not be used** to form new listings.

**Example: CSNA111**

**CSN** Closed Loop Current Sensor

### Current Range (Peak/RMS nom.)

- A**  $\pm 70$  A/50 A rms nom.
- B**  $\pm 100$  A/50 A rms nom.
- C**  $\pm 90$  A/50 A rms nom.
- D**  $\pm 22$  A/15 A rms nom.
- E**  $\pm 36$  A/25 A rms nom.
- F**  $\pm 150$  A/100 A rms nom.
- J**  $\pm 600$  A/300 A rms nom.
- K**  $\pm 1200$  A/500 A rms nom.
- L**  $\pm 600$  A/300 A rms nom.
- M**  $\pm 1200$  A/500 A rms nom.
- P**  $\pm 90$  A/50 A rms nom.
- R**  $\pm 200$  A/125 A rms nom.
- T**  $\pm 150$  A/50 A rms nom.

### Supply Voltage

- 1**  $\pm 15$  V
- 2**  $\pm 13$  V
- 3**  $\pm 5$  V
- 4**  $\pm 12$  V to 18 V
- 5**  $\pm 15$  V to 24 V
- 6**  $\pm 12$  V to 15 V

### Coil Characteristics

- 1** 1:1000 turns/90  $\Omega$  @ 70°C
- 2** 1:2000 turns/160  $\Omega$  @ 70°C
- 3** 1:2000 turns/130  $\Omega$  @ 70°C
- 4** 1:1000 turns/50  $\Omega$  @ 70°C
- 5** 1:1000 turns/110  $\Omega$  @ 70°C
- 6** 1:1000 turns/30  $\Omega$  @ 70°C
- 7** 1:2000 turns/80  $\Omega$  @ 70°C
- 8** 1:2000 turns/25  $\Omega$  @ 70°C
- 9** 1:5000 turns/50  $\Omega$  @ 85°C

### Housing Material

- 1** Polycarbonate/ABS blend

# Solid State Sensors

## Closed Loop Current Sensors

CSN Series

### CSNA, CSNB, CSNE SERIES ORDER GUIDE

Catalog Listing	Current Range Amps	Supply Voltage VDC $\pm 5\%$	Coil Characteristics		Meas. Currents Nom.	Meas. Resist (@ $I_{nom}$ )
			Turns	Resistance		
CSNA111	$\pm 70$	$\pm 15$	1000	90 $\Omega$ @ 70°C	50 mA for 50 A	40 to 130 $\Omega$
CSNB121	$\pm 100$	$\pm 15$	2000	160 $\Omega$ @ 70°C	25 mA for 50 A	40 to 270 $\Omega$
CSNB131	$\pm 100$	$\pm 15$	2000	130 $\Omega$ @ 70°C	25 mA for 50 A	40 to 300 $\Omega$
CSNE151	$\pm 5-36$	$\pm 15$	1000	110 $\Omega$ @ 70°C	25 mA for 25 A	100 to 320 $\Omega$
CSNE381*	$\pm 5-36$	$\pm 5V$	1000	66 $\Omega$ @ 70°C	25 mA for 25 A	0 to 84 $\Omega$
CSNH151*	$\pm 4-43$	$\pm 15V$	1000	110 $\Omega$ @ 70°C	25 mA for 25 A	100 to 320 $\Omega$

NOTE: Extended temperature range and potting also available.

\* Contact the 800 number for more information.

### SPECIFICATIONS

Catalog Listing	CSNA111	CSNB121	CSNB131	CSNE151
Offset Current @ 25°C, mA max.	$\pm 0.20$	$\pm 0.10$	$\pm 0.10$	$\pm 0.10$
Temperature Drift, 0 to 70°C, mA	$\pm 0.35$ typ. $\pm 0.60$ max.	$\pm 0.20$ typ. $\pm 0.30$ max.	$\pm 0.20$ typ. $\pm 0.30$ max.	$\pm 0.17$ typ. $\pm 0.60$ max.
Linearity	0.1%	0.1%	0.1%	0.2%
Supply Voltage	$\pm 15V$	$\pm 15V$	$\pm 15V$	$\pm 15V$
Galvanic Isolation @ 50 Hz/1 min.	2.5 kV rms			5 kV rms
Accuracy	$\pm 0.5\%$ of $I_N$ (nominal Current) at 25°C			
Response Time	$< 1 \mu s$			
Bandwidth	DC to 150 kHz			
Temperature	Operating: 0 to 70°C (32 to 150°F)		Storage: -25 to 85°C (-13 to 185°F)	
Primary Circuit Connection	Thru-hole	Thru-hole	Thru-hole	Invasive on 10 pins
Secondary Circuit Connection	3 Pins	3 Pins	3 Pins	3 Pins
Current Drain	10 mA (no load current) + output current (secondary current)			
"In-Out" Sense Signal	To obtain positive measuring current on O/P terminal, current must flow in direction of arrow			
Mounting	PCB, 3 pins, hole size 0.95 mm			PCB, 13 pins

### PRIMARY PIN CONNECTIONS FOR CSNE151

Primary Turns	Primary Current		Output Current (mA)	Primary Resistance (m $\Omega$ )	Primary Pin Connections
	Nom. $I_{DN}$ (A)	Max. $I_D$ (A)			
1	24	36	25	0.3	
2	12	18	24	1.1	
3	8	12	24	2.5	
4	6	9	24	4.4	
5	5	7	25	6.3	

Current

### WIRING DIAGRAMS

#### CSNA111/CSNB121/CSNB131



#### CSNE151



# Solid State Sensors

## Closed Loop Current Sensors

CSN Series

MOUNTING DIMENSIONS (for reference only)

CSNA111, CSNB121, CSNB131



CSNE151/CSNE381



CSNH151

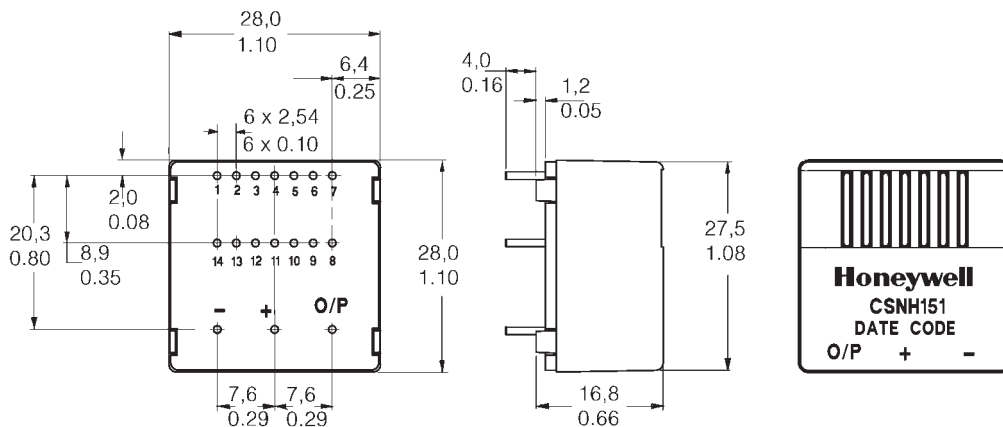

# Solid State Sensors

## Closed Loop Current Sensors

CSN Series

### CSNJ, CSNK SERIES ORDER GUIDE

Catalog Listings	Current Range Amps	Supply Voltage VDC $\pm 5\%$	Coil Characteristics		Meas. Currents Nom.	Meas. Resist (@ $I_{nom}$ )
			Turns	Resistance		
CSNJ481	$\pm 600$	$\pm 12$ to 18	2000	25 $\Omega$ @ 70°C	150 mA for 300 A	0 to 70 $\Omega$
CSNJ481-001*	$\pm 600$	$\pm 12$ to 18	2000	25 $\Omega$ @ 70°C	150 mA for 300 A	0 to 70 $\Omega$
CSNJ481-002	$\pm 600$	$\pm 12$ to 18	2000	25 $\Omega$ @ 70°C	150 mA for 300 A	0 to 70 $\Omega$
CSNJ481-003*	$\pm 600$	$\pm 12$ to 18	2000	25 $\Omega$ @ 70°C	150 mA for 300 A	0 to 70 $\Omega$
CSNK591	$\pm 1200$	$\pm 15$ to 24	5000	50 $\Omega$ @ 70°C	100 mA for 500 A	0 to 130 $\Omega$
CSNK591-001*	$\pm 1200$	$\pm 15$ to 24	5000	50 $\Omega$ @ 70°C	100 mA for 500 A	0 to 130 $\Omega$
CSNK591-002	$\pm 1200$	$\pm 15$ to 24	5000	50 $\Omega$ @ 70°C	100 mA for 500 A	0 to 130 $\Omega$
CSNK591-003*	$\pm 1200$	$\pm 15$ to 24	5000	50 $\Omega$ @ 70°C	100 mA for 500 A	0 to 130 $\Omega$

\*Fitted with busbar

### SPECIFICATIONS

Catalog Listings	CSNJ481 CSNJ481-001	CSNJ481-002 CSNJ481-003	CSNK591 CSNK591-001	CSNK591-002 CSNK591-003
Offset Current @ 25°C, mA max.	$\pm 0.30$	$\pm 0.30$	$\pm 0.20$	$\pm 0.20$
Temperature Drift, 0 to 70°C, mA	$\pm 0.30$ typ. $\pm 0.50$ max.	$\pm 0.30$ typ. $\pm 0.50$ max.	$\pm 0.20$ typ. $\pm 0.30$ max.	$\pm 0.20$ typ. $\pm 0.30$ max.
Linearity	$\pm 0.1\%$	$\pm 0.1\%$	$\pm 0.1\%$	$\pm 0.1\%$
Supply Voltage	$\pm 12$ to $\pm 18$ V	$\pm 12$ to $\pm 18$ V	$\pm 15$ to $\pm 24$ V	$\pm 15$ to $\pm 24$ V
Galvanic Isolation @ 50 Hz/1 min.	7.5 kV rms	7.5 kV rms	6 kV rms	6 kV rms
Accuracy	$\pm 0.5\%$ of $I_n$ (nominal Current) at 25°C			
Response Time	<1 $\mu$ s			
Bandwidth	DC to 150 kHz			
Operating Temperature	-40 to 85°C (-40 to 185°F)	0 to 70°C (32 to 158°F)	-40 to 85°C (-40 to 185°F)	0 to 70°C (32 to 158°F)
Storage Temperature	-40 to 90°C (-40 to 194°F)	-25 to 85°C (-13 to 85°F)	-40 to 90°C (-40 to 194°F)	-25 to 85°C (-13 to 85°F)
Primary Circuit Connection	Thru-hole or busbar	Thru-hole or busbar	Thru-hole or busbar	Thru-hole or busbar
Secondary Circuit Connection	3 pins	3 pins	3 pins	3 pins
Current Drain	14 mA (no load current) + output current		22 mA (24 V) + output current	
"In-Out" Sense Signal	To obtain positive measuring current on O/P terminal, current must flow in direction of arrow			
Mounting	Faston, 3 pins		Push-on (spade), 3 terminals	

### WIRING DIAGRAM

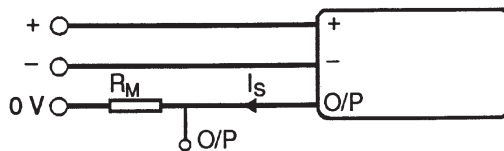

Current

# Solid State Sensors

## Closed Loop Current Sensors

CSN Series

MOUNTING DIMENSIONS (for reference only)

### CSNJ481

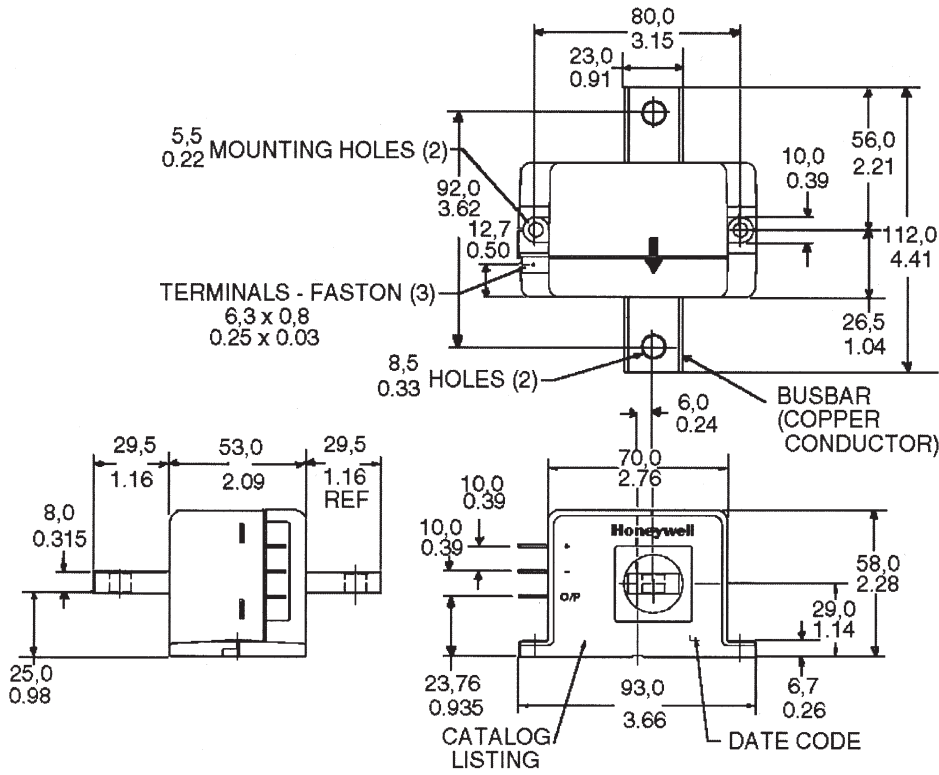

### CSNK591

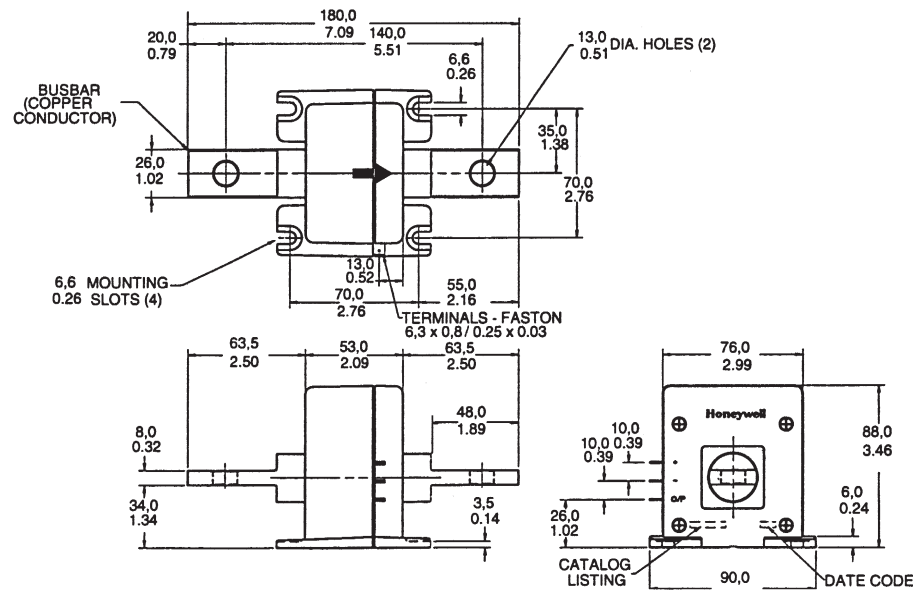

# Solid State Sensors

## Closed Loop Current Sensors

CSN Series

### CSNL, CSNM SERIES ORDER GUIDE

Catalog Listings	Peak Current Range Amps	Supply Voltage VDC $\pm 5\%$	Coil Characteristics		Meas. Currents Nom.	Meas. Resist (@ $I_{nom}$ )
			Turns	Resistance		
CSNL181	$\pm 600$	$\pm 12$ to 18	2000	$25\Omega @ 70^\circ\text{C}$	150 mA for 300 A	0 to $70\Omega$
CSNM191	$\pm 1000$	$\pm 12$ to 18	5000	$50\Omega @ 70^\circ\text{C}$	100 mA for 500 A	0 to $120\Omega$

### SPECIFICATIONS

Catalog Listings	CSNL181	CSNM191
Offset Current @ $25^\circ\text{C}$ , mA max.	$\pm 0.30$	$\pm 0.20$
Temperature Drift, 0 to $70^\circ\text{C}$ , mA	$\pm 0.30$ typ. $\pm 0.50$ max.	$\pm 0.20$ typ. $\pm 0.30$ max.
Linearity	$\pm 0.1\%$	$\pm 0.1\%$
Supply Voltage	$\pm 12$ to $\pm 18\text{V}$	$\pm 12$ to $\pm 18\text{V}$
Galvanic Isolation @ 50 Hz/1 min.	7.5 kV rms	7.5 kV rms
Accuracy	$\pm 0.5\%$ of $I_N$ (nominal Current) at $25^\circ\text{C}$	
Response Time	500 ns	$< 1 \mu\text{s}$
Bandwidth	DC to 150 kHz	
Operating Temperature	$-40$ to $85^\circ\text{C}$ ( $-40$ to $185^\circ\text{F}$ )	
Storage Temperature	$-40$ to $90^\circ\text{C}$ ( $-40$ to $194^\circ\text{F}$ )	
Primary Circuit Connection	Thru-hole	Thru-hole
Secondary Circuit Connection	3 pins	3 pins
Current Drain	14 mA (no load current) + output current	
"In-Out" Sense Signal	To obtain positive measuring current on O/P terminal, current must flow in direction of arrow	
Mounting	Faston, 3 pins	

### WIRING DIAGRAM



Current

# Solid State Sensors

## Closed Loop Current Sensors

CSN Series

MOUNTING DIMENSIONS (for reference only)

### CSNL181



### CSNM191



# Solid State Sensors

## Closed Loop Current Sensors

CSN Series

### CSNF, CSNR, CSNP, CSNT SERIES ORDER GUIDE

Catalog Listings	Peak Current Range Amps	Supply Voltage VDC $\pm 5\%$	Coil Characteristics		Meas. Currents Nom.	Meas. Resist (@ $I_{nom}$ )
			Turns	Resistance		
CSNP661	$\pm 90$	$\pm 12$ to 15	1000	30 $\Omega$ @ 70°C	50 mA for 50 A	50 to 100 $\Omega$
CSNT651	$\pm 150$	$\pm 12$ to 15	2000	100 $\Omega$ @ 70°C	25 mA for 50 A	40 to 75 $\Omega$
CSNF161	$\pm 150$	$\pm 12$ to 15	1000	30 $\Omega$ @ 70°C	100 mA for 100 A	10 to 40 $\Omega$
CSNF151	$\pm 180$	$\pm 12$ to 15	2000	100 $\Omega$ @ 70°C	50 mA for 100 A	10 to 75 $\Omega$
CSNR161	$\pm 200$	$\pm 12$ to 15	1000	30 $\Omega$ @ 70°C	125 mA for 125 A	30 to 40 $\Omega$
CSNR151	$\pm 200$	$\pm 12$ to 15	2000	100 $\Omega$ @ 70°C	62.5 mA for 125 A	10 to 40 $\Omega$

NOTE: Busbar options available.

### SPECIFICATIONS

Catalog Listings	CSNP661	CSNT651	CSNF161	CSNF151	CSNR161	CSNR151
Offset Current @ 25°C, mA max.	$\pm 0.20$	$\pm 0.10$	$\pm 0.20$	$\pm 0.10$	$\pm 0.20$	$\pm 0.10$
Temperature Drift, 0 to 70°C, mA	$\pm 0.30$ typ. $\pm 0.50$ max.	$\pm 0.15$ typ. $\pm 0.25$ max.	$\pm 0.30$ typ. $\pm 0.50$ max.	$\pm 0.15$ typ. $\pm 0.25$ max.	$\pm 0.30$ typ. $\pm 0.60$ max.	$\pm 0.15$ typ. $\pm 0.30$ max.
Linearity	$\pm 0.1\%$	$\pm 0.1\%$	$\pm 0.1\%$	$\pm 0.1\%$	$\pm 0.1\%$	$\pm 0.1\%$
Supply Voltage	$\pm 12$ to 15V	$\pm 12$ to 15V	$\pm 12$ to 15V	$\pm 12$ to 15V	$\pm 12$ to 15V	$\pm 12$ to 15V
Galvanic Isolation @ 50 Hz/1 min.	3 kV rms	3 kV rms	3 kV rms	3 kV rms	3 kV rms	3 kV rms
Accuracy	$\pm 0.5\%$ of $I_N$ (nominal Current) at 25°C					
Response Time	<500 ns					
Bandwidth	DC to 150 kHz					
Operating Temperature	-40 to 85°C (-40 to 185°F)		-40 to 85°C (-40 to 185°F)			
Storage Temperature	-40 to 90°C (-40 to 194°F)		-40 to 90°C (-40 to 194°F)			
Primary Circuit Connection	Thru-hole					
Secondary Circuit Connection	3 pins					
Current Drain	10 mA (no load current) + output current		14 mA (no load current) + output current			
"In-Out" Sense Signal	To obtain positive measuring current on O/P terminal, current must flow in direction of arrow					
Mounting	3 pins					
Pin Style	A	A	B	B	B	B

### WIRING DIAGRAM



Current



# Solid State Sensors

## Closed Loop Current Sensors

CSN Series

MOUNTING DIMENSIONS (for reference only)

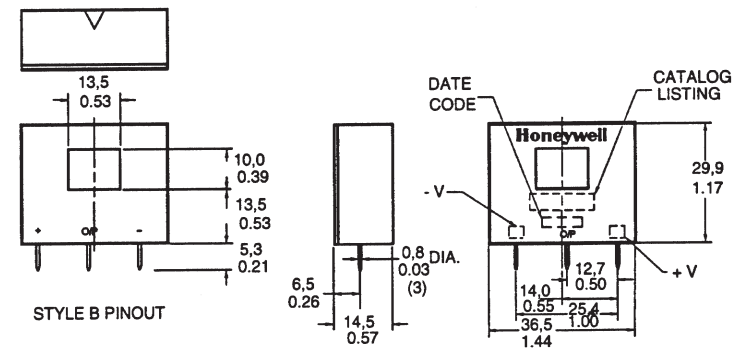
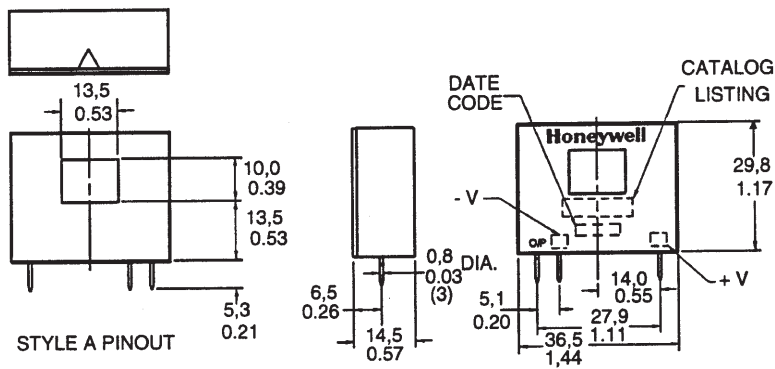
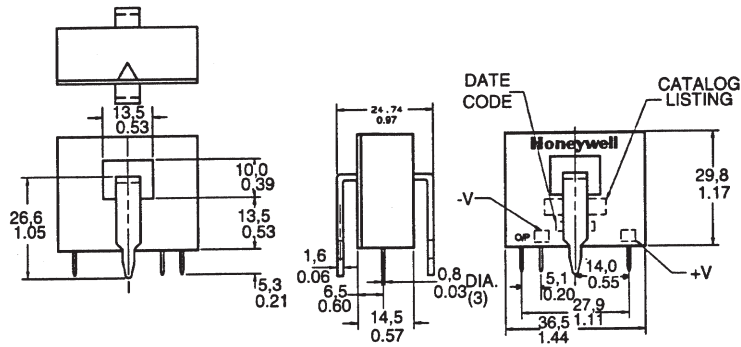

## Данный компонент на территории Российской Федерации

### Вы можете приобрести в компании MosChip.

Для оперативного оформления запроса Вам необходимо перейти по данной ссылке:

<http://moschip.ru/get-element>

Вы можете разместить у нас заказ для любого Вашего проекта, будь то серийное производство или разработка единичного прибора.

В нашем ассортименте представлены ведущие мировые производители активных и пассивных электронных компонентов.

Нашей специализацией является поставка электронной компонентной базы двойного назначения, продукции таких производителей как XILINX, Intel (ex.ALTERA), Vicor, Microchip, Texas Instruments, Analog Devices, Mini-Circuits, Amphenol, Glenair.

Сотрудничество с глобальными дистрибьюторами электронных компонентов, предоставляет возможность заказывать и получать с международных складов практически любой перечень компонентов в оптимальные для Вас сроки.

На всех этапах разработки и производства наши партнеры могут получить квалифицированную поддержку опытных инженеров.

Система менеджмента качества компании отвечает требованиям в соответствии с ГОСТ Р ИСО 9001, ГОСТ РВ 0015-002 и ЭС РД 009

### Офис по работе с юридическими лицами:

105318, г.Москва, ул.Щербаковская д.3, офис 1107, 1118, ДЦ «Щербаковский»

Телефон: +7 495 668-12-70 (многоканальный)

Факс: +7 495 668-12-70 (доб.304)

E-mail: [info@moschip.ru](mailto:info@moschip.ru)

Skype отдела продаж:

moschip.ru

moschip.ru\_4

moschip.ru\_6

moschip.ru\_9