

# IS61NLF12836A/IS61NVF12836A IS61NLF25618A/IS61NVF25618A



## 128K x 36 and 256K x 18 4Mb, FLOW THROUGH 'NO WAIT' STATE BUS SRAM

AUGUST 2011

### FEATURES

- 100 percent bus utilization
- No wait cycles between Read and Write
- Internal self-timed write cycle
- Individual Byte Write Control
- Single Read/Write control pin
- Clock controlled, registered address, data and control
- Interleaved or linear burst sequence control using MODE input
- Three chip enables for simple depth expansion and address pipelining
- Power Down mode
- Common data inputs and data outputs
- $\overline{\text{CKE}}$  pin to enable clock and suspend operation
- JEDEC 100-pin TQFP, 119-ball PBGA, and 165-ball PBGA packages
- Power supply:  
NVF:  $V_{\text{DD}} 2.5\text{V} (\pm 5\%)$ ,  $V_{\text{DDQ}} 2.5\text{V} (\pm 5\%)$   
NLF:  $V_{\text{DD}} 3.3\text{V} (\pm 5\%)$ ,  $V_{\text{DDQ}} 3.3\text{V}/2.5\text{V} (\pm 5\%)$
- Industrial temperature available
- Lead-free available

### DESCRIPTION

The 4 Meg 'NLF/NVF' product family feature high-speed, low-power synchronous static RAMs designed to provide a burstable, high-performance, 'no wait' state, device for networking and communications applications. They are organized as 128K words by 36 bits and 256K words by 18 bits, fabricated with ISSI's advanced CMOS technology.

Incorporating a 'no wait' state feature, wait cycles are eliminated when the bus switches from read to write, or write to read. This device integrates a 2-bit burst counter, high-speed SRAM core, and high-drive capability outputs into a single monolithic circuit.

All synchronous inputs pass through registers are controlled by a positive-edge-triggered single clock input. Operations may be suspended and all synchronous inputs ignored when Clock Enable,  $\overline{\text{CKE}}$  is HIGH. In this state the internal device will hold their previous values.

All Read, Write and Deselect cycles are initiated by the ADV input. When the ADV is HIGH the internal burst counter is incremented. New external addresses can be loaded when ADV is LOW.

Write cycles are internally self-timed and are initiated by the rising edge of the clock inputs and when  $\overline{\text{WE}}$  is LOW. Separate byte enables allow individual bytes to be written.

A burst mode pin (MODE) defines the order of the burst sequence. When tied HIGH, the interleaved burst sequence is selected. When tied LOW, the linear burst sequence is selected.

### FAST ACCESS TIME

| Symbol          | Parameter         | 6.5 | 7.5 | Units |
|-----------------|-------------------|-----|-----|-------|
| $t_{\text{KQ}}$ | Clock Access Time | 6.5 | 7.5 | ns    |
| $t_{\text{KC}}$ | Cycle Time        | 7.5 | 8.5 | ns    |
|                 | Frequency         | 133 | 117 | MHz   |

Copyright © 2011 Integrated Silicon Solution, Inc. All rights reserved. ISSI reserves the right to make changes to this specification and its products at any time without notice. ISSI assumes no liability arising out of the application or use of any information, products or services described herein. Customers are advised to obtain the latest version of this device specification before relying on any published information and before placing orders for products.

Integrated Silicon Solution, Inc. does not recommend the use of any of its products in life support applications where the failure or malfunction of the product can reasonably be expected to cause failure of the life support system or to significantly affect its safety or effectiveness. Products are not authorized for use in such applications unless Integrated Silicon Solution, Inc. receives written assurance to its satisfaction, that:

- a.) the risk of injury or damage has been minimized;
- b.) the user assume all such risks; and
- c.) potential liability of Integrated Silicon Solution, Inc is adequately protected under the circumstances

**BLOCK DIAGRAM**





Bottom View  
119-Ball, 14 mm x 22 mm BGA



Bottom View  
165-Ball, 13 mm x 15mm BGA

**PIN CONFIGURATION — 128K x 36, 165-Ball PBGA (TOP VIEW)**

|   | 1    | 2   | 3               | 4                | 5                | 6                | 7                | 8               | 9    | 10  | 11   |
|---|------|-----|-----------------|------------------|------------------|------------------|------------------|-----------------|------|-----|------|
| A | NC   | A   | $\overline{CE}$ | $\overline{BWc}$ | $\overline{BWb}$ | $\overline{CE2}$ | $\overline{CKE}$ | ADV             | NC   | A   | NC   |
| B | NC   | A   | CE2             | $\overline{BWd}$ | $\overline{BWa}$ | CLK              | $\overline{WE}$  | $\overline{OE}$ | NC   | A   | NC   |
| C | DQPc | NC  | VDDQ            | VSS              | VSS              | VSS              | VSS              | VSS             | VDDQ | NC  | DQPb |
| D | DQc  | DQc | VDDQ            | VDD              | VSS              | VSS              | VSS              | VDD             | VDDQ | DQb | DQb  |
| E | DQc  | DQc | VDDQ            | VDD              | VSS              | VSS              | VSS              | VDD             | VDDQ | DQb | DQb  |
| F | DQc  | DQc | VDDQ            | VDD              | VSS              | VSS              | VSS              | VDD             | VDDQ | DQb | DQb  |
| G | DQc  | DQc | VDDQ            | VDD              | VSS              | VSS              | VSS              | VDD             | VDDQ | DQb | DQb  |
| H | NC   | NC  | NC              | VDD              | VSS              | VSS              | VSS              | VDD             | NC   | NC  | ZZ   |
| J | DQd  | DQd | VDDQ            | VDD              | VSS              | VSS              | VSS              | VDD             | VDDQ | DQa | DQa  |
| K | DQd  | DQd | VDDQ            | VDD              | VSS              | VSS              | VSS              | VDD             | VDDQ | DQa | DQa  |
| L | DQd  | DQd | VDDQ            | VDD              | VSS              | VSS              | VSS              | VDD             | VDDQ | DQa | DQa  |
| M | DQd  | DQd | VDDQ            | VDD              | VSS              | VSS              | VSS              | VDD             | VDDQ | DQa | DQa  |
| N | DQPd | NC  | VDDQ            | VSS              | NC               | NC               | NC               | VSS             | VDDQ | NC  | DQPa |
| P | NC   | NC  | A               | A                | NC               | A1*              | NC               | A               | A    | A   | NC   |
| R | MODE | NC  | A               | A                | NC               | A0*              | NC               | A               | A    | A   | A    |

**Note:** A0 and A1 are the two least significant bits (LSB) of the address field and set the internal burst counter if burst is desired.

**PIN DESCRIPTIONS**

| Symbol                                   | Pin Name                               |
|--|--|
| A  | Address Inputs                         |
| A0, A1                                   | Synchronous Burst Address Inputs       |
| ADV                                      | Synchronous Burst Address Advance/Load |
| $\overline{WE}$                          | Synchronous Read/Write Control Input   |
| CLK                                      | Synchronous Clock                      |
| $\overline{CKE}$                         | Clock Enable                           |
| $\overline{CE}$ , $\overline{CE2}$ , CE2 | Synchronous Chip Enable                |
| $\overline{BWx}$ (x=a-d)                 | Synchronous Byte Write Inputs          |
| $\overline{OE}$                          | Output Enable                          |
| ZZ                                       | Power Sleep Mode                       |

|      |   |
|------|---|
| MODE | Burst Sequence Selection                  |
| VDD  | 3.3V/2.5V Power Supply                    |
| NC   | No Connect                                |
| DQx  | Data Inputs/Outputs                       |
| DQPx | Parity Data I/O                           |
| VDDQ | Isolated output Power Supply<br>3.3V/2.5V |
| VSS  | Ground                                    |

**119-PIN PBGA PACKAGE CONFIGURATION —128K x 36 (TOP VIEW)**

|   | 1                | 2                | 3                                 | 4                       | 5                                 | 6                       | 7                |
|---|------------------|------------------|-----------------------------------|-------------------------|-----------------------------------|-------------------------|------------------|
| A | V <sub>DDQ</sub> | A                | A                                 | NC                      | A                                 | A                       | V <sub>DDQ</sub> |
| B | NC               | CE2              | A                                 | ADV                     | A                                 | $\overline{\text{CE2}}$ | NC               |
| C | NC               | A                | A                                 | V <sub>DD</sub>         | A                                 | A                       | NC               |
| D | DQ <sub>c</sub>  | DQP <sub>c</sub> | V <sub>SS</sub>                   | NC                      | V <sub>SS</sub>                   | DQP <sub>b</sub>        | DQ <sub>b</sub>  |
| E | DQ <sub>c</sub>  | DQ <sub>c</sub>  | V <sub>SS</sub>                   | $\overline{\text{CE}}$  | V <sub>SS</sub>                   | DQ <sub>b</sub>         | DQ <sub>b</sub>  |
| F | V <sub>DDQ</sub> | DQ <sub>c</sub>  | V <sub>SS</sub>                   | $\overline{\text{OE}}$  | V <sub>SS</sub>                   | DQ <sub>b</sub>         | V <sub>DDQ</sub> |
| G | DQ <sub>c</sub>  | DQ <sub>c</sub>  | $\overline{\text{BW}}_{\text{c}}$ | NC                      | $\overline{\text{BW}}_{\text{b}}$ | DQ <sub>b</sub>         | DQ <sub>b</sub>  |
| H | DQ <sub>c</sub>  | DQ <sub>c</sub>  | V <sub>SS</sub>                   | $\overline{\text{WE}}$  | V <sub>SS</sub>                   | DQ <sub>b</sub>         | DQ <sub>b</sub>  |
| J | V <sub>DDQ</sub> | V <sub>DD</sub>  | NC                                | V <sub>DD</sub>         | NC                                | V <sub>DD</sub>         | V <sub>DDQ</sub> |
| K | DQ <sub>d</sub>  | DQ <sub>d</sub>  | V <sub>SS</sub>                   | CLK                     | V <sub>SS</sub>                   | DQ <sub>a</sub>         | DQ <sub>a</sub>  |
| L | DQ <sub>d</sub>  | DQ <sub>d</sub>  | $\overline{\text{BW}}_{\text{d}}$ | NC                      | $\overline{\text{BW}}_{\text{a}}$ | DQ <sub>a</sub>         | DQ <sub>a</sub>  |
| M | V <sub>DDQ</sub> | DQ <sub>d</sub>  | V <sub>SS</sub>                   | $\overline{\text{CKE}}$ | V <sub>SS</sub>                   | DQ <sub>a</sub>         | V <sub>DDQ</sub> |
| N | DQ <sub>d</sub>  | DQ <sub>d</sub>  | V <sub>SS</sub>                   | A <sub>1</sub> *        | V <sub>SS</sub>                   | DQ <sub>a</sub>         | DQ <sub>a</sub>  |
| P | DQ <sub>d</sub>  | DQP <sub>d</sub> | V <sub>SS</sub>                   | A <sub>0</sub> *        | V <sub>SS</sub>                   | DQP <sub>a</sub>        | DQ <sub>a</sub>  |
| R | NC               | A                | MODE                              | V <sub>DD</sub>         | NC                                | A                       | NC               |
| T | NC               | NC               | A                                 | A                       | A                                 | NC                      | ZZ               |
| U | V <sub>DDQ</sub> | NC               | NC                                | NC                      | NC                                | NC                      | V <sub>DDQ</sub> |

**Note:** A0 and A1 are the two least significant bits (LSB) of the address field and set the internal burst counter if burst is desired.

**PIN DESCRIPTIONS**

| Symbol                                    | Pin Name                               |
|---|--|
| A   | Address Inputs                         |
| A0, A1                                    | Synchronous Burst Address Inputs       |
| ADV                                       | Synchronous Burst Address Advance/Load |
| $\overline{\text{WE}}$                    | Synchronous Read/Write Control Input   |
| CLK                                       | Synchronous Clock                      |
| $\overline{\text{CKE}}$                   | Clock Enable                           |
| $\overline{\text{CE}}$                    | Synchronous Chip Select                |
| $\overline{\text{CE2}}$                   | Synchronous Chip Select                |
| CE2                                       | Synchronous Chip Select                |
| $\overline{\text{BW}}_{\text{x}}$ (x=a-d) | Synchronous Byte Write Inputs          |

|                                  |                          |
|----------------------------------|--------------------------|
| $\overline{\text{OE}}$           | Output Enable            |
| ZZ                               | Power Sleep Mode         |
| MODE                             | Burst Sequence Selection |
| V <sub>DD</sub>                  | Power Supply             |
| V <sub>SS</sub>                  | Ground                   |
| NC                               | No Connect               |
| DQ <sub>a</sub> -DQ <sub>d</sub> | Data Inputs/Outputs      |
| DQP <sub>a</sub> -Pd             | Parity Data I/O          |
| V <sub>DDQ</sub>                 | Output Power Supply      |

**165-PIN PBGA PACKAGE CONFIGURATION —256K x 18 (TOP VIEW)**

|   | 1                | 2               | 3               | 4                | 5                | 6                | 7                | 8               | 9    | 10              | 11               |
|---|------------------|-----------------|-----------------|------------------|------------------|------------------|------------------|-----------------|------|-----------------|------------------|
| A | NC               | A               | $\overline{CE}$ | $\overline{BWb}$ | NC               | $\overline{CE2}$ | $\overline{CKE}$ | ADV             | NC   | A               | A                |
| B | NC               | A               | CE2             | NC               | $\overline{BWa}$ | CLK              | $\overline{WE}$  | $\overline{OE}$ | NC   | A               | NC               |
| C | NC               | NC              | VDDQ            | Vss              | Vss              | Vss              | Vss              | Vss             | VDDQ | NC              | DQP <sub>a</sub> |
| D | NC               | DQ <sub>b</sub> | VDDQ            | VDD              | Vss              | Vss              | Vss              | VDD             | VDDQ | NC              | DQ <sub>a</sub>  |
| E | NC               | DQ <sub>b</sub> | VDDQ            | VDD              | Vss              | Vss              | Vss              | VDD             | VDDQ | NC              | DQ <sub>a</sub>  |
| F | NC               | DQ <sub>b</sub> | VDDQ            | VDD              | Vss              | Vss              | Vss              | VDD             | VDDQ | NC              | DQ <sub>a</sub>  |
| G | NC               | DQ <sub>b</sub> | VDDQ            | VDD              | Vss              | Vss              | Vss              | VDD             | VDDQ | NC              | DQ <sub>a</sub>  |
| H | NC               | NC              | NC              | VDD              | Vss              | Vss              | Vss              | VDD             | NC   | NC              | ZZ               |
| J | DQ <sub>b</sub>  | NC              | VDDQ            | VDD              | Vss              | Vss              | Vss              | VDD             | VDDQ | DQ <sub>a</sub> | NC               |
| K | DQ <sub>b</sub>  | NC              | VDDQ            | VDD              | Vss              | Vss              | Vss              | VDD             | VDDQ | DQ <sub>a</sub> | NC               |
| L | DQ <sub>b</sub>  | NC              | VDDQ            | VDD              | Vss              | Vss              | Vss              | VDD             | VDDQ | DQ <sub>a</sub> | NC               |
| M | DQ <sub>b</sub>  | NC              | VDDQ            | VDD              | Vss              | Vss              | Vss              | VDD             | VDDQ | DQ <sub>a</sub> | NC               |
| N | DQP <sub>b</sub> | NC              | VDDQ            | Vss              | NC               | NC               | NC               | Vss             | VDDQ | NC              | NC               |
| P | NC               | NC              | A               | A                | NC               | A <sub>1</sub> * | NC               | A               | A    | A               | NC               |
| R | MODE             | NC              | A               | A                | NC               | A <sub>0</sub> * | NC               | A               | A    | A               | A                |

**Note:** A0 and A1 are the two least significant bits (LSB) of the address field and set the internal burst counter if burst is desired.

**PIN DESCRIPTIONS**

| Symbol                                   | Pin Name                               |
|--|--|
| A  | Address Inputs                         |
| A0, A1                                   | Synchronous Burst Address Inputs       |
| ADV                                      | Synchronous Burst Address Advance/Load |
| $\overline{WE}$                          | Synchronous Read/Write Control Input   |
| CLK                                      | Synchronous Clock                      |
| $\overline{CKE}$                         | Clock Enable                           |
| $\overline{CE}$ , $\overline{CE2}$ , CE2 | Synchronous Chip Enable                |
| $\overline{BWx}$ (x=a,b)                 | Synchronous Byte Write Inputs          |
| $\overline{OE}$                          | Output Enable                          |
| ZZ                                       | Power Sleep Mode                       |

|                  |   |
|------------------|---|
| MODE             | Burst Sequence Selection                  |
| VDD              | 3.3V/2.5V Power Supply                    |
| NC               | No Connect                                |
| DQ <sub>x</sub>  | Data Inputs/Outputs                       |
| DQP <sub>x</sub> | Parity Data I/O                           |
| VDDQ             | Isolated output Power Supply<br>3.3V/2.5V |
| Vss              | Ground                                    |

**119-PIN PBGA PACKAGE CONFIGURATION —256K x 18 (TOP VIEW)**

|   | 1    | 2    | 3                | 4                | 5                | 6                | 7    |
|---|------|------|------------------|------------------|------------------|------------------|------|
| A | VDDQ | A    | A                | NC               | A                | A                | VDDQ |
| B | NC   | CE2  | A                | ADV              | A                | $\overline{CE2}$ | NC   |
| C | NC   | A    | A                | VDD              | A                | A                | NC   |
| D | DQb  | NC   | VSS              | NC               | VSS              | DQPa             | NC   |
| E | NC   | DQb  | VSS              | $\overline{CE}$  | VSS              | NC               | DQa  |
| F | VDDQ | NC   | VSS              | $\overline{OE}$  | VSS              | DQa              | VDDQ |
| G | NC   | DQb  | $\overline{BWb}$ | NC               | NC               | NC               | DQa  |
| H | DQb  | NC   | VSS              | $\overline{WE}$  | VSS              | DQa              | NC   |
| J | VDDQ | VDD  | NC               | VDD              | NC               | VDD              | VDDQ |
| K | NC   | DQb  | VSS              | CLK              | VSS              | NC               | DQa  |
| L | DQb  | NC   | NC               | NC               | $\overline{BWa}$ | DQa              | NC   |
| M | VDDQ | DQb  | VSS              | $\overline{CKE}$ | VSS              | NC               | VDDQ |
| N | DQb  | NC   | VSS              | A1*              | VSS              | DQa              | NC   |
| P | NC   | DQPb | VSS              | A0*              | VSS              | NC               | DQa  |
| R | NC   | A    | MODE             | VDD              | NC               | A                | NC   |
| T | NC   | A    | A                | NC               | A                | A                | ZZ   |
| U | VDDQ | NC   | NC               | NC               | NC               | NC               | VDDQ |

**Note:** A0 and A1 are the two least significant bits (LSB) of the address field and set the internal burst counter if burst is desired.

**PIN DESCRIPTIONS**

| Symbol                   | Pin Name                               |
|--------------------------|--|
| A                        | Address Inputs                         |
| A0, A1                   | Synchronous Burst Address Inputs       |
| ADV                      | Synchronous Burst Address Advance/Load |
| $\overline{WE}$          | Synchronous Read/Write Control Input   |
| CLK                      | Synchronous Clock                      |
| $\overline{CKE}$         | Clock Enable                           |
| $\overline{CE}$          | Synchronous Chip Select                |
| $\overline{CE2}$         | Synchronous Chip Select                |
| CE2                      | Synchronous Chip Select                |
| $\overline{BWx}$ (x=a,b) | Synchronous Byte Write Inputs          |

|                 |                          |
|-----------------|--------------------------|
| $\overline{OE}$ | Output Enable            |
| ZZ              | Power Sleep Mode         |
| MODE            | Burst Sequence Selection |
| VDD             | Power Supply             |
| VSS             | Ground                   |
| NC              | No Connect               |
| DQa-DQb         | Data Inputs/Outputs      |
| DQPa-Pb         | Parity Data I/O          |
| VDDQ            | Output Power Supply      |

**PIN CONFIGURATION**  
**100-Pin TQFP**

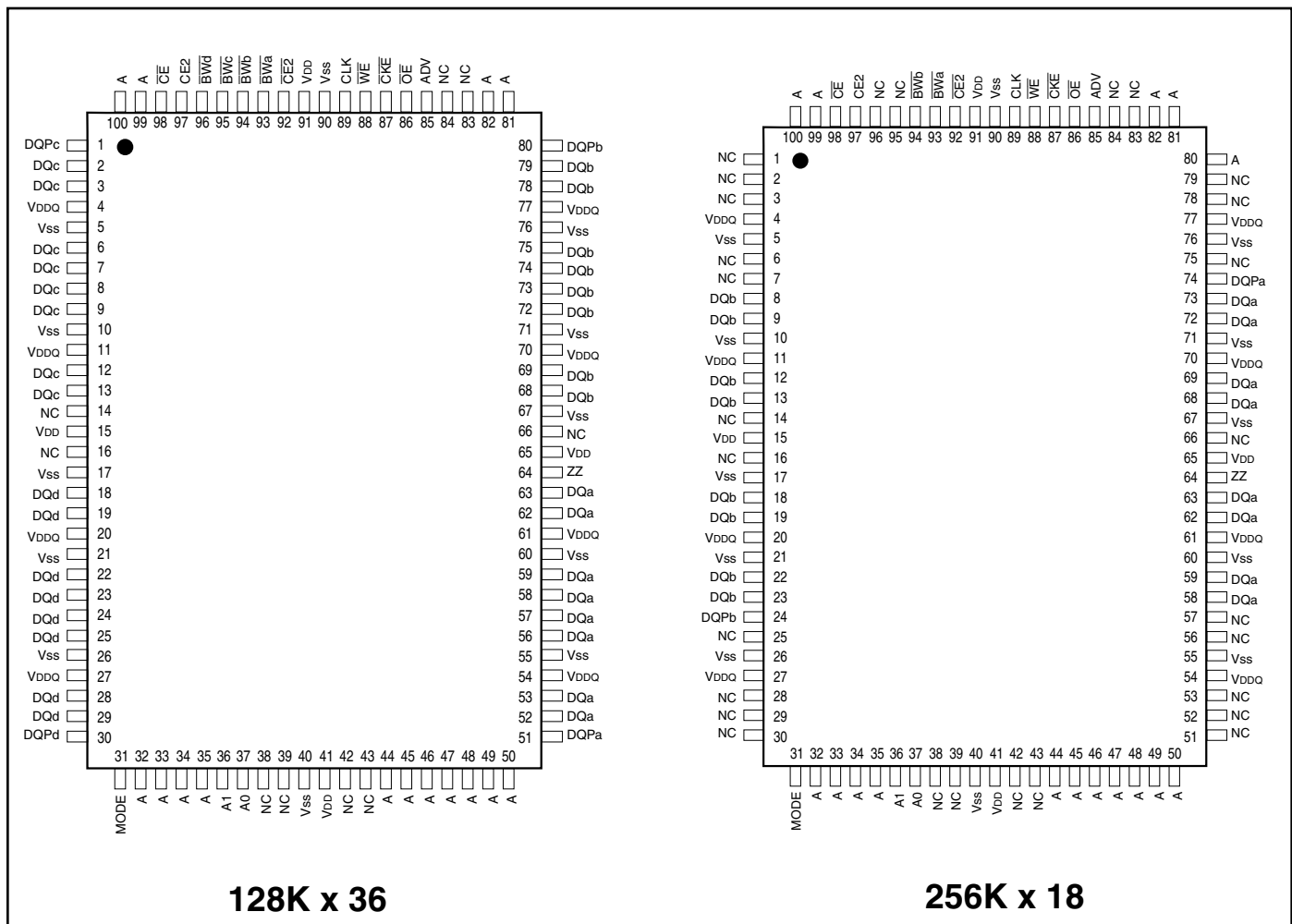

**PIN DESCRIPTIONS**

|                                     |   |
|-------------------------------------|---|
| A0, A1                              | Synchronous Address Inputs. These pins must be tied to the two LSBs of the address bus. |
| A                                   | Synchronous Address Inputs  |
| CLK                                 | Synchronous Clock   |
| ADV                                 | Synchronous Burst Address Advance   |
| $\overline{BWA}$ - $\overline{BWD}$ | Synchronous Byte Write Enable   |
| $\overline{WE}$                     | Write Enable  |
| $\overline{CKE}$                    | Clock Enable  |
| Vss                                 | Ground for Core   |
| NC                                  | Not Connected   |

|  |   |
|--|---|
| $\overline{CE}$ , $\overline{CE2}$ , $\overline{CE\overline{2}}$ | Synchronous Chip Enable                   |
| $\overline{OE}$  | Output Enable                             |
| DQa-DQd  | Synchronous Data Input/Output             |
| DQPa-DQPd  | Parity Data I/O                           |
| MODE   | Burst Sequence Selection                  |
| VDD  | +3.3V/2.5V Power Supply                   |
| Vss  | Ground for output Buffer                  |
| VDDQ   | Isolated Output Buffer Supply: +3.3V/2.5V |
| ZZ   | Snooze Enable                             |



## STATE DIAGRAM

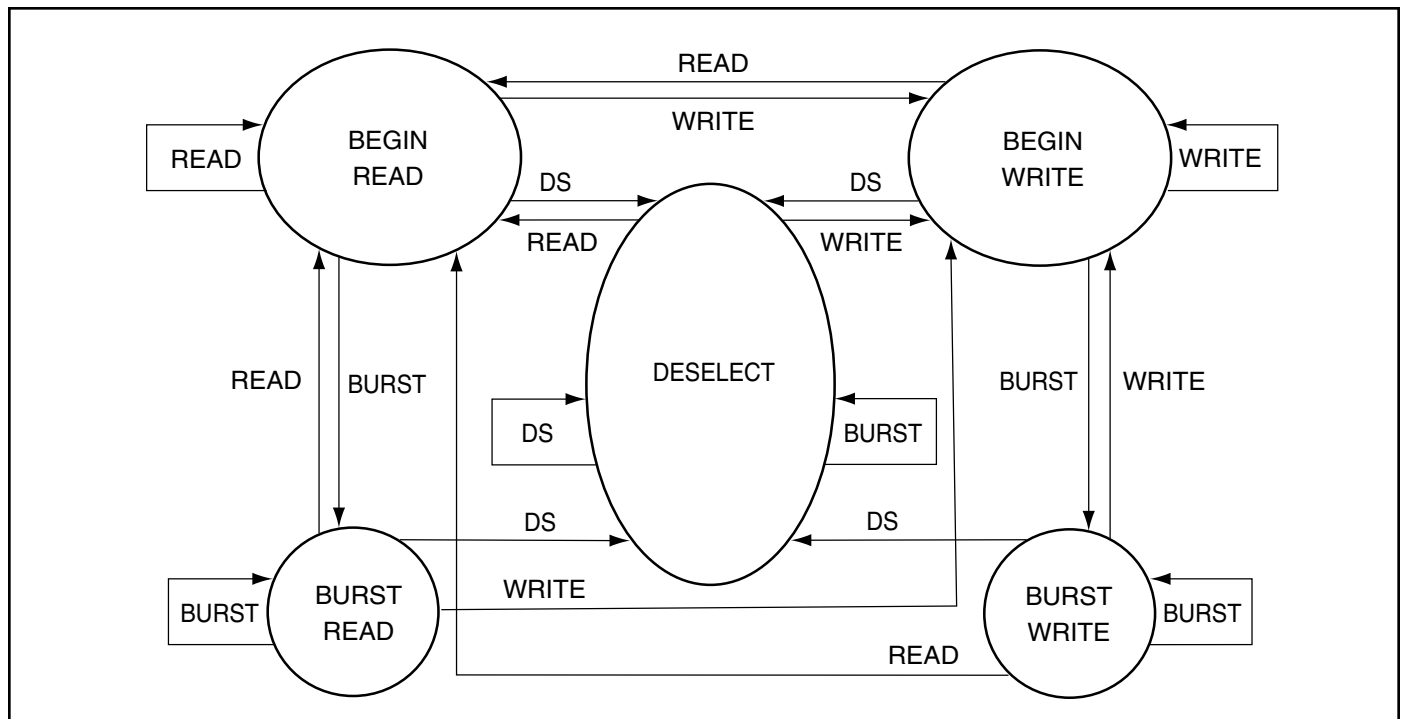

## SYNCHRONOUS TRUTH TABLE<sup>(1)</sup>

| Operation             | Address Used     | $\overline{CE}$ | CE2 | $\overline{CE2}$ | ADV | $\overline{WE}$ | $\overline{BWx}$ | $\overline{OE}$ | $\overline{CKE}$ | CLK |
|-----------------------|------------------|-----------------|-----|------------------|-----|-----------------|------------------|-----------------|------------------|-----|
| Not Selected          | N/A              | H               | X   | X                | L   | X               | X                | X               | L                | ↑   |
| Not Selected          | N/A              | X               | L   | X                | L   | X               | X                | X               | L                | ↑   |
| Not Selected          | N/A              | X               | X   | H                | L   | X               | X                | X               | L                | ↑   |
| Not Selected Continue | N/A              | X               | X   | X                | H   | X               | X                | X               | L                | ↑   |
| Begin Burst Read      | External Address | L               | H   | L                | L   | H               | X                | L               | L                | ↑   |
| Continue Burst Read   | Next Address     | X               | X   | X                | H   | X               | X                | L               | L                | ↑   |
| NOP/Dummy Read        | External Address | L               | H   | L                | L   | H               | X                | H               | L                | ↑   |
| Dummy Read            | Next Address     | X               | X   | X                | H   | X               | X                | H               | L                | ↑   |
| Begin Burst Write     | External Address | L               | H   | L                | L   | L               | L                | X               | L                | ↑   |
| Continue Burst Write  | Next Address     | X               | X   | X                | H   | X               | L                | X               | L                | ↑   |
| NOP/Write Abort       | N/A              | L               | H   | L                | L   | L               | H                | X               | L                | ↑   |
| Write Abort           | Next Address     | X               | X   | X                | H   | X               | H                | X               | L                | ↑   |
| Ignore Clock          | Current Address  | X               | X   | X                | X   | X               | X                | X               | H                | ↑   |

### Notes:

- "X" means don't care.
- The rising edge of clock is symbolized by ↑
- A continue deselect cycle can only be entered if a deselect cycle is executed first.
- $\overline{WE} = L$  means Write operation in Write Truth Table.  
 $\overline{WE} = H$  means Read operation in Write Truth Table.
- Operation finally depends on status of asynchronous pins ( $\overline{ZZ}$  and  $\overline{OE}$ ).

**ASYNCHRONOUS TRUTH TABLE<sup>(1)</sup>**

| Operation  | ZZ | $\overline{OE}$ | I/O STATUS  |
|------------|----|-----------------|-------------|
| Sleep Mode | H  | X               | High-Z      |
| Read       | L  | L               | DQ          |
|            | L  | H               | High-Z      |
| Write      | L  | X               | Din, High-Z |
| Deselected | L  | X               | High-Z      |

**Notes:**

1. X means "Don't Care".
2. For write cycles following read cycles, the output buffers must be disabled with  $\overline{OE}$ , otherwise data bus contention will occur.
3. Sleep Mode means power Sleep Mode where stand-by current does not depend on cycle time.
4. Deselected means power Sleep Mode where stand-by current depends on cycle time.

**WRITE TRUTH TABLE (x18)**

| Operation       | $\overline{WE}$ | $\overline{Bw}a$ | $\overline{Bw}b$ |
|-----------------|-----------------|------------------|------------------|
| READ            | H               | X                | X                |
| WRITE BYTE a    | L               | L                | H                |
| WRITE BYTE b    | L               | H                | L                |
| WRITE ALL BYTES | L               | L                | L                |
| WRITE ABORT/NOP | L               | H                | H                |

**Notes:**

1. X means "Don't Care".
2. All inputs in this table must be setup and hold time around the rising edge of CLK.

**WRITE TRUTH TABLE** (x36)

| Operation       | $\overline{WE}$ | $\overline{BWa}$ | $\overline{BWb}$ | $\overline{BWc}$ | $\overline{BWd}$ |
|-----------------|-----------------|------------------|------------------|------------------|------------------|
| READ            | H               | X                | X                | X                | X                |
| WRITE BYTE a    | L               | L                | H                | H                | H                |
| WRITE BYTE b    | L               | H                | L                | H                | H                |
| WRITE BYTE c    | L               | H                | H                | L                | H                |
| WRITE BYTE d    | L               | H                | H                | H                | L                |
| WRITE ALL BYTES | L               | L                | L                | L                | L                |
| WRITE ABORT/NOP | L               | H                | H                | H                | H                |

**Notes:**

1. X means "Don't Care".
2. All inputs in this table must be setup and hold time around the rising edge of CLK.

**INTERLEAVED BURST ADDRESS TABLE** (MODE = V<sub>DD</sub> or NC)

| External Address<br>A1 A0 | 1st Burst Address<br>A1 A0 | 2nd Burst Address<br>A1 A0 | 3rd Burst Address<br>A1 A0 |
|---------------------------|----------------------------|----------------------------|----------------------------|
| 00                        | 01                         | 10                         | 11                         |
| 01                        | 00                         | 11                         | 10                         |
| 10                        | 11                         | 00                         | 01                         |
| 11                        | 10                         | 01                         | 00                         |

**LINEAR BURST ADDRESS TABLE (MODE = V<sub>SS</sub>)**

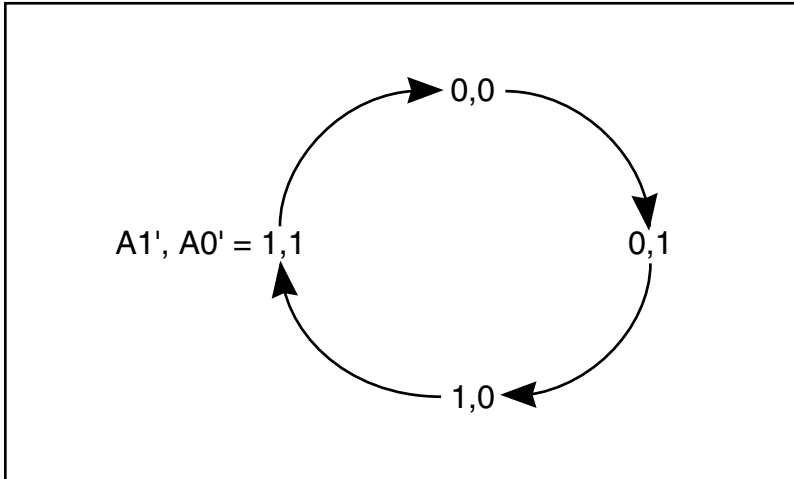

**ABSOLUTE MAXIMUM RATINGS<sup>(1)</sup>**

| Symbol                             | Parameter   | Value                          | Unit |
|------------------------------------|---|--------------------------------|------|
| T <sub>STG</sub>                   | Storage Temperature   | -65 to +150                    | °C   |
| P <sub>D</sub>                     | Power Dissipation   | 1.6                            | W    |
| I <sub>OUT</sub>                   | Output Current (per I/O)  | 100                            | mA   |
| V <sub>IN</sub> , V <sub>OUT</sub> | Voltage Relative to V <sub>SS</sub> for I/O Pins                          | -0.5 to V <sub>DDQ</sub> + 0.3 | V    |
| V <sub>IN</sub>                    | Voltage Relative to V <sub>SS</sub> for<br>for Address and Control Inputs | -0.3 to 4.6                    | V    |

**Notes:**

1. Stress greater than those listed under ABSOLUTE MAXIMUM RATINGS may cause permanent damage to the device. This is a stress rating only and functional operation of the device at these or any other conditions above those indicated in the operational sections of this specification is not implied. Exposure to absolute maximum rating conditions for extended periods may affect reliability.
2. This device contains circuitry to protect the inputs against damage due to high static voltages or electric fields; however, precautions may be taken to avoid application of any voltage higher than maximum rated voltages to this high-impedance circuit.
3. This device contains circuitry that will ensure the output devices are in High-Z at power up.

**OPERATING RANGE (IS61NLFx)**

| Range      | Ambient Temperature | V <sub>DD</sub> | V <sub>DDQ</sub> |
|------------|---------------------|-----------------|------------------|
| Commercial | 0°C to +70°C        | 3.3V ± 5%       | 3.3V / 2.5V ± 5% |
| Industrial | -40°C to +85°C      | 3.3V ± 5%       | 3.3V / 2.5V ± 5% |

**IS61NLF12836A/IS61NVF12836A**  
**IS61NLF25618A/IS61NVF25618A**

**OPERATING RANGE (IS61NVF<sub>x</sub>)**

| Range      | Ambient Temperature | V <sub>DD</sub> | V <sub>DDQ</sub> |
|------------|---------------------|-----------------|------------------|
| Commercial | 0°C to +70°C        | 2.5V ± 5%       | 2.5V ± 5%        |
| Industrial | -40°C to +85°C      | 2.5V ± 5%       | 2.5V ± 5%        |

**DC ELECTRICAL CHARACTERISTICS** (Over Operating Range)

| Symbol          | Parameter              | Test Conditions  | 3.3V |                       | 2.5V |                       | Unit |
|-----------------|------------------------|--|------|-----------------------|------|-----------------------|------|
|                 |                        |  | Min. | Max.                  | Min. | Max.                  |      |
| V <sub>OH</sub> | Output HIGH Voltage    | I <sub>OH</sub> = -4.0 mA (3.3V)<br>I <sub>OH</sub> = -1.0 mA (2.5V)         | 2.4  | —                     | 2.0  | —                     | V    |
| V <sub>OL</sub> | Output LOW Voltage     | I <sub>OL</sub> = 8.0 mA (3.3V)<br>I <sub>OL</sub> = 1.0 mA (2.5V)           | —    | 0.4                   | —    | 0.4                   | V    |
| V <sub>IH</sub> | Input HIGH Voltage     |  | 2.0  | V <sub>DD</sub> + 0.3 | 1.7  | V <sub>DD</sub> + 0.3 | V    |
| V <sub>IL</sub> | Input LOW Voltage      |  | -0.3 | 0.8                   | -0.3 | 0.7                   | V    |
| I <sub>LI</sub> | Input Leakage Current  | V <sub>SS</sub> ≤ V <sub>IN</sub> ≤ V <sub>DD</sub> <sup>(1)</sup>           | -5   | 5                     | -5   | 5                     | μA   |
| I <sub>LO</sub> | Output Leakage Current | V <sub>SS</sub> ≤ V <sub>OUT</sub> ≤ V <sub>DDQ</sub> , OE = V <sub>IH</sub> | -5   | 5                     | -5   | 5                     | μA   |

**POWER SUPPLY CHARACTERISTICS<sup>(1)</sup>** (Over Operating Range)

| Symbol           | Parameter                   | Test Conditions  | Temp. range         | 6.5 MAX |     | 7.5 MAX |     | Unit |
|------------------|-----------------------------|--|---------------------|---------|-----|---------|-----|------|
|                  |                             |  |                     | x18     | x36 | x18     | x36 |      |
| I <sub>CC</sub>  | AC Operating Supply Current | Device Selected,   | Com.                | 175     | 175 | 155     | 155 | mA   |
|                  |                             | OE = V <sub>IH</sub> , ZZ ≤ V <sub>IL</sub> ,<br>All Inputs ≤ 0.2V or ≥ V <sub>DD</sub> - 0.2V,<br>Cycle Time ≥ t <sub>kc</sub> min. | Ind.                | 180     | 180 | 160     | 160 |      |
|                  |                             |  | typ. <sup>(2)</sup> | 120     |     | 110     |     |      |
| I <sub>SB</sub>  | Standby Current TTL Input   | Device Deselected,   | Com.                | 90      | 90  | 90      | 90  | mA   |
|                  |                             | V <sub>DD</sub> = Max.,<br>All Inputs ≤ V <sub>IL</sub> or ≥ V <sub>IH</sub> ,<br>ZZ ≤ V <sub>IL</sub> , f = Max.                    | Ind.                | 100     | 100 | 100     | 100 |      |
| I <sub>SB1</sub> | Standby Current CMOS Input  | Device Deselected,   | Com.                | 70      | 70  | 70      | 70  | mA   |
|                  |                             | V <sub>DD</sub> = Max.,<br>V <sub>IN</sub> ≤ V <sub>SS</sub> + 0.2V or ≥ V <sub>DD</sub> - 0.2V<br>f = 0                             | Ind.                | 75      | 75  | 75      | 75  |      |
|                  |                             |  | typ. <sup>(2)</sup> | 40      |     | 40      |     |      |
| I <sub>SB2</sub> | Sleep Mode                  | ZZ > V <sub>IH</sub>   | Com.                | 30      | 30  | 30      | 30  | mA   |
|                  |                             |  | Ind.                | 35      | 35  | 35      | 35  |      |
|                  |                             |  | typ. <sup>(2)</sup> | 20      |     | 20      |     |      |

**Note:**

- MODE pin has an internal pullup and should be tied to V<sub>DD</sub> or V<sub>SS</sub>. It exhibits ±100 μA maximum leakage current when tied to ≤ V<sub>SS</sub> + 0.2V or ≥ V<sub>DD</sub> - 0.2V.
- Typical values are measured at V<sub>DD</sub> = 3.3V, T<sub>A</sub> = 25°C and not 100% tested.

### CAPACITANCE<sup>(1,2)</sup>

| Symbol           | Parameter                | Conditions            | Max. | Unit |
|------------------|--------------------------|-----------------------|------|------|
| C <sub>IN</sub>  | Input Capacitance        | V <sub>IN</sub> = 0V  | 6    | pF   |
| C <sub>OUT</sub> | Input/Output Capacitance | V <sub>OUT</sub> = 0V | 8    | pF   |

**Notes:**

1. Tested initially and after any design or process changes that may affect these parameters.
2. Test conditions: T<sub>A</sub> = 25°C, f = 1 MHz, V<sub>DD</sub> = 3.3V.

### 3.3V I/O AC TEST CONDITIONS

| Parameter                                   | Unit                |
|---|---------------------|
| Input Pulse Level                           | 0V to 3.0V          |
| Input Rise and Fall Times                   | 1.5 ns              |
| Input and Output Timing and Reference Level | 1.5V                |
| Output Load                                 | See Figures 1 and 2 |

### 3.3V I/O OUTPUT LOAD EQUIVALENT



Figure 1



Figure 2

**2.5V I/O AC TEST CONDITIONS**

| Parameter                                   | Unit                |
|---|---------------------|
| Input Pulse Level                           | 0V to 2.5V          |
| Input Rise and Fall Times                   | 1.5 ns              |
| Input and Output Timing and Reference Level | 1.25V               |
| Output Load                                 | See Figures 3 and 4 |

**2.5V I/O OUTPUT LOAD EQUIVALENT**



**Figure 3**



**Figure 4**

**READ/WRITE CYCLE SWITCHING CHARACTERISTICS<sup>(1)</sup>** (Over Operating Range)

| Symbol                 | Parameter                       | 6.5  |      | 7.5  |      | Unit |
|------------------------|---------------------------------|------|------|------|------|------|
|                        |                                 | Min. | Max. | Min. | Max. |      |
| fmax                   | Clock Frequency                 | —    | 133  | —    | 117  | MHz  |
| tkc                    | Cycle Time                      | 7.5  | —    | 8.5  | —    | ns   |
| tkH                    | Clock High Time                 | 2.2  | —    | 2.5  | —    | ns   |
| tkL                    | Clock Low Time                  | 2.2  | —    | 2.5  | —    | ns   |
| tkQ                    | Clock Access Time               | —    | 6.5  | —    | 7.5  | ns   |
| tkQX <sup>(2)</sup>    | Clock High to Output Invalid    | 2.5  | —    | 2.5  | —    | ns   |
| tkQLZ <sup>(2,3)</sup> | Clock High to Output Low-Z      | 2.5  | —    | 2.5  | —    | ns   |
| tkQHZ <sup>(2,3)</sup> | Clock High to Output High-Z     | —    | 3.8  | —    | 4.0  | ns   |
| toEQ                   | Output Enable to Output Valid   | —    | 3.2  | —    | 3.4  | ns   |
| toELZ <sup>(2,3)</sup> | Output Enable to Output Low-Z   | 0    | —    | 0    | —    | ns   |
| toEHZ <sup>(2,3)</sup> | Output Disable to Output High-Z | —    | 3.5  | —    | 3.5  | ns   |
| tAS                    | Address Setup Time              | 1.5  | —    | 1.5  | —    | ns   |
| tWS                    | Read/Write Setup Time           | 1.5  | —    | 1.5  | —    | ns   |
| tCES                   | Chip Enable Setup Time          | 1.5  | —    | 1.5  | —    | ns   |
| tSE                    | Clock Enable Setup Time         | 1.5  | —    | 1.5  | —    | ns   |
| tADVS                  | Address Advance Setup Time      | 1.5  | —    | 1.5  | —    | ns   |
| tDS                    | Data Setup Time                 | 1.5  | —    | 1.5  | —    | ns   |
| tAH                    | Address Hold Time               | 0.5  | —    | 0.5  | —    | ns   |
| tHE                    | Clock Enable Hold Time          | 0.5  | —    | 0.5  | —    | ns   |
| tWH                    | Write Hold Time                 | 0.5  | —    | 0.5  | —    | ns   |
| tCEH                   | Chip Enable Hold Time           | 0.5  | —    | 0.5  | —    | ns   |
| tADVH                  | Address Advance Hold Time       | 0.5  | —    | 0.5  | —    | ns   |
| tDH                    | Data Hold Time                  | 0.5  | —    | 0.5  | —    | ns   |
| tpDS                   | ZZ High to Power Down           | —    | 2    | —    | 2    | cyc  |
| tpUS                   | ZZ Low to Power Down            | —    | 2    | —    | 2    | cyc  |

**Notes:**

1. Configuration signal MODE is static and must not change during normal operation.
2. Guaranteed but not 100% tested. This parameter is periodically sampled.
3. Tested with load in Figure 2.



**SLEEP MODE ELECTRICAL CHARACTERISTICS**

| Symbol     | Parameter                         | Conditions       | Min. | Max. | Unit  |
|------------|-----------------------------------|------------------|------|------|-------|
| $I_{SB2}$  | Current during SLEEP MODE         | $ZZ \geq V_{IH}$ |      | 35   | mA    |
| $t_{PDS}$  | ZZ active to input ignored        |                  |      | 2    | cycle |
| $t_{PUS}$  | ZZ inactive to input sampled      |                  | 2    |      | cycle |
| $t_{ZZI}$  | ZZ active to SLEEP current        |                  | 2    |      | cycle |
| $t_{RZZI}$ | ZZ inactive to exit SLEEP current |                  | 0    |      | ns    |

**SLEEP MODE TIMING**



READ CYCLE TIMING

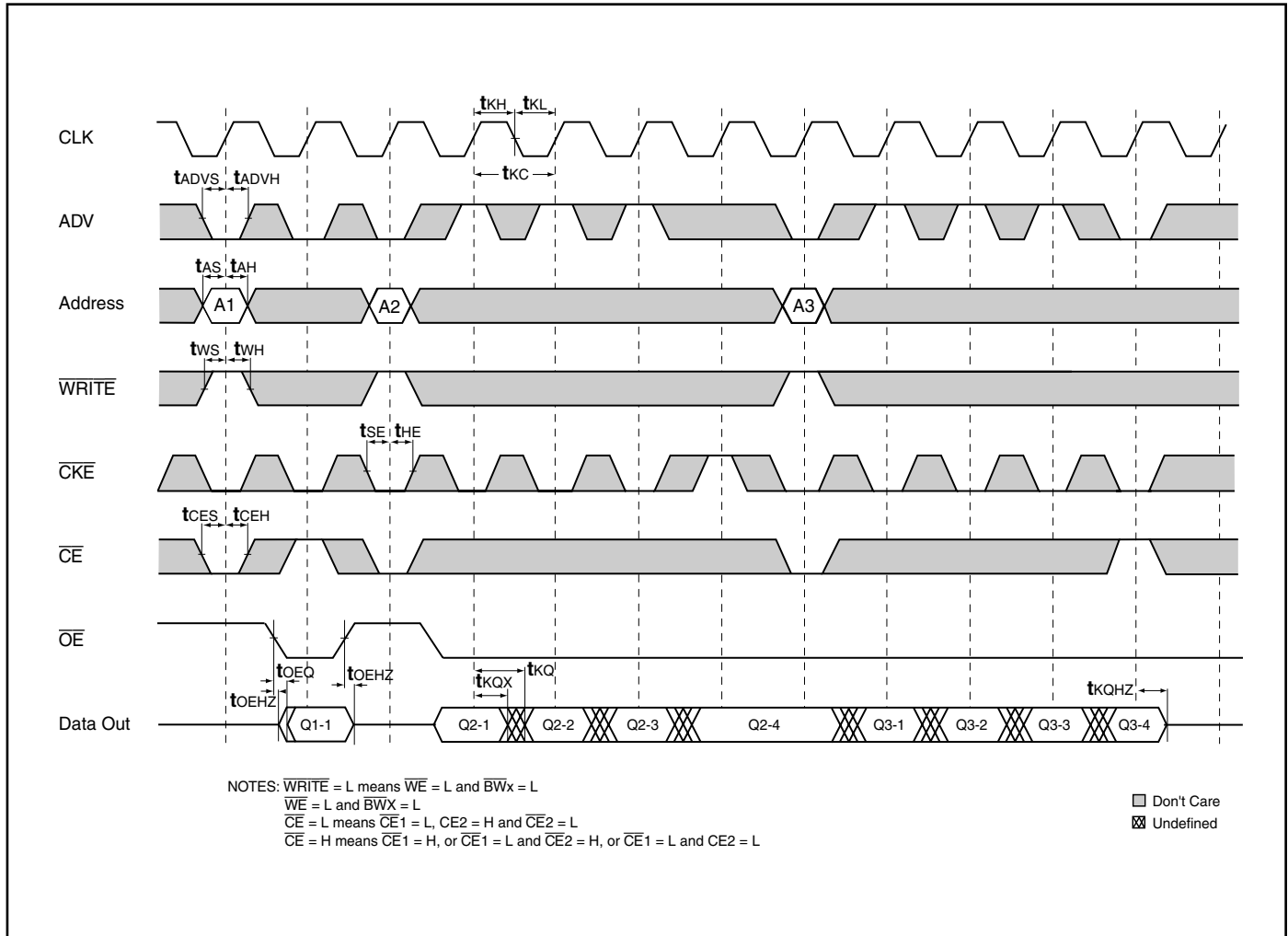

## WRITE CYCLE TIMING



**SINGLE READ/WRITE CYCLE TIMING**



**CKE OPERATION TIMING**

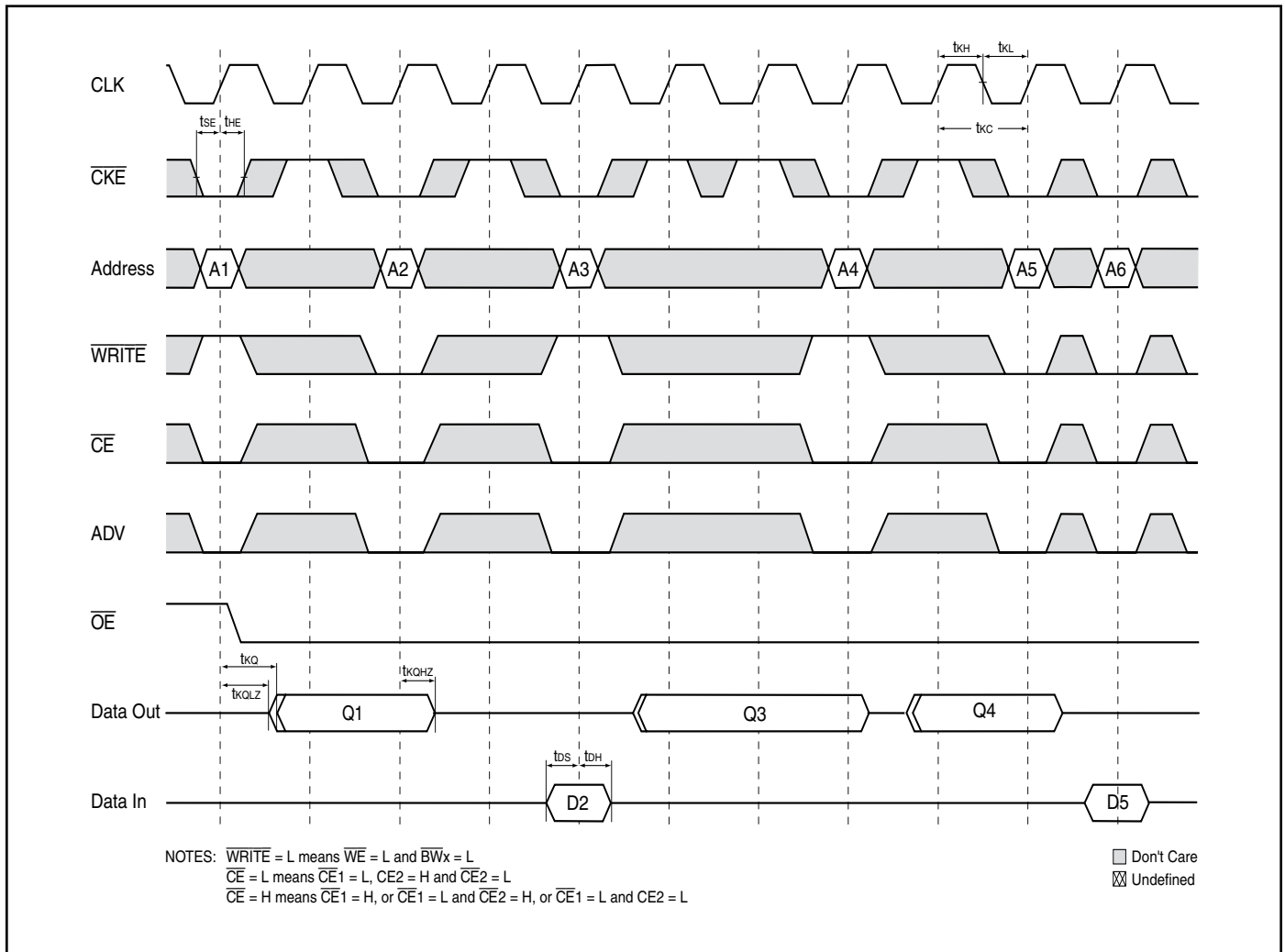

**CE OPERATION TIMING**





**IS61NLF12836A/IS61NVF12836A**  
**IS61NLF25618A/IS61NVF25618A**

**ORDERING INFORMATION ( $V_{DD} = 3.3V/V_{DDQ} = 2.5V/3.3V$ )**  
**Commercial Range: 0°C to +70°C**

| Access Time    | Order Part Number   | Package  |
|----------------|---------------------|----------|
| <b>128Kx36</b> |                     |          |
| 6.5            | IS61NLF12836A-6.5TQ | 100 TQFP |
|                | IS61NLF12836A-6.5B2 | 119 PBGA |
|                | IS61NLF12836A-6.5B3 | 165 PBGA |
| 7.5            | IS61NLF12836A-7.5TQ | 100 TQFP |
|                | IS61NLF12836A-7.5B2 | 119 PBGA |
|                | IS61NLF12836A-7.5B3 | 165 PBGA |
| <b>256Kx18</b> |                     |          |
| 6.5            | IS61NLF25618A-6.5TQ | 100 TQFP |
|                | IS61NLF25618A-6.5B2 | 119 PBGA |
|                | IS61NLF25618A-6.5B3 | 165 PBGA |
| 7.5            | IS61NLF25618A-7.5TQ | 100 TQFP |
|                | IS61NLF25618A-7.5B2 | 119 PBGA |
|                | IS61NLF25618A-7.5B3 | 165 PBGA |

**Industrial Range: -40°C to +85°C**

| Access Time    | Order Part Number     | Package             |
|----------------|-----------------------|---------------------|
| <b>128Kx36</b> |                       |                     |
| 6.5            | IS61NLF12836A-6.5TQI  | 100 TQFP            |
|                | IS61NLF12836A-6.5B2I  | 119 PBGA            |
|                | IS61NLF12836A-6.5B3I  | 165 PBGA            |
| 7.5            | IS61NLF12836A-7.5TQI  | 100 TQFP            |
|                | IS61NLF12836A-7.5TQLI | 100 TQFP, Lead-free |
|                | IS61NLF12836A-7.5B2I  | 119 PBGA            |
|                | IS61NLF12836A-7.5B3I  | 165 PBGA            |
|                | IS61NLF12836A-7.5B3LI | 165 PBGA, Lead-free |
| <b>256Kx18</b> |                       |                     |
| 6.5            | IS61NLF25618A-6.5TQI  | 100 TQFP            |
|                | IS61NLF25618A-6.5B2I  | 119 PBGA            |
|                | IS61NLF25618A-6.5B3I  | 165 PBGA            |
| 7.5            | IS61NLF25618A-7.5TQI  | 100 TQFP            |
|                | IS61NLF25618A-7.5TQLI | 100 TQFP, Lead-free |
|                | IS61NLF25618A-7.5B2I  | 119 PBGA            |
|                | IS61NLF25618A-7.5B3I  | 165 PBGA            |

**ORDERING INFORMATION (V<sub>DD</sub> = 2.5V/V<sub>DDQ</sub> = 2.5V)**

**Commercial Range: 0°C to +70°C**

| Access Time    | Order Part Number   | Package  |
|----------------|---------------------|----------|
| <b>128Kx36</b> |                     |          |
| 6.5            | IS61NVF12836A-6.5TQ | 100 TQFP |
|                | IS61NVF12836A-6.5B2 | 119 PBGA |
|                | IS61NVF12836A-6.5B3 | 165 PBGA |
| 7.5            | IS61NVF12836A-7.5TQ | 100 TQFP |
|                | IS61NVF12836A-7.5B2 | 119 PBGA |
|                | IS61NVF12836A-7.5B3 | 165 PBGA |
| <b>256Kx18</b> |                     |          |
| 6.5            | IS61NVF25618A-6.5TQ | 100 TQFP |
|                | IS61NVF25618A-6.5B2 | 119 PBGA |
|                | IS61NVF25618A-6.5B3 | 165 PBGA |
| 7.5            | IS61NVF25618A-7.5TQ | 100 TQFP |
|                | IS61NVF25618A-7.5B2 | 119 PBGA |
|                | IS61NVF25618A-7.5B3 | 165 PBGA |

**Industrial Range: -40°C to +85°C**

| Access Time    | Order Part Number    | Package  |
|----------------|----------------------|----------|
| <b>128Kx36</b> |                      |          |
| 6.5            | IS61NVF12836A-6.5TQI | 100 TQFP |
|                | IS61NVF12836A-6.5B2I | 119 PBGA |
|                | IS61NVF12836A-6.5B3I | 165 PBGA |
| 7.5            | IS61NVF12836A-7.5TQI | 100 TQFP |
|                | IS61NVF12836A-7.5B2I | 119 PBGA |
|                | IS61NVF12836A-7.5B3I | 165 PBGA |
| <b>256Kx18</b> |                      |          |
| 6.5            | IS61NVF25618A-6.5TQI | 100 TQFP |
|                | IS61NVF25618A-6.5B2I | 119 PBGA |
|                | IS61NVF25618A-6.5B3I | 165 PBGA |
| 7.5            | IS61NVF25618A-7.5TQI | 100 TQFP |
|                | IS61NVF25618A-7.5B2I | 119 PBGA |
|                | IS61NVF25618A-7.5B3I | 165 PBGA |



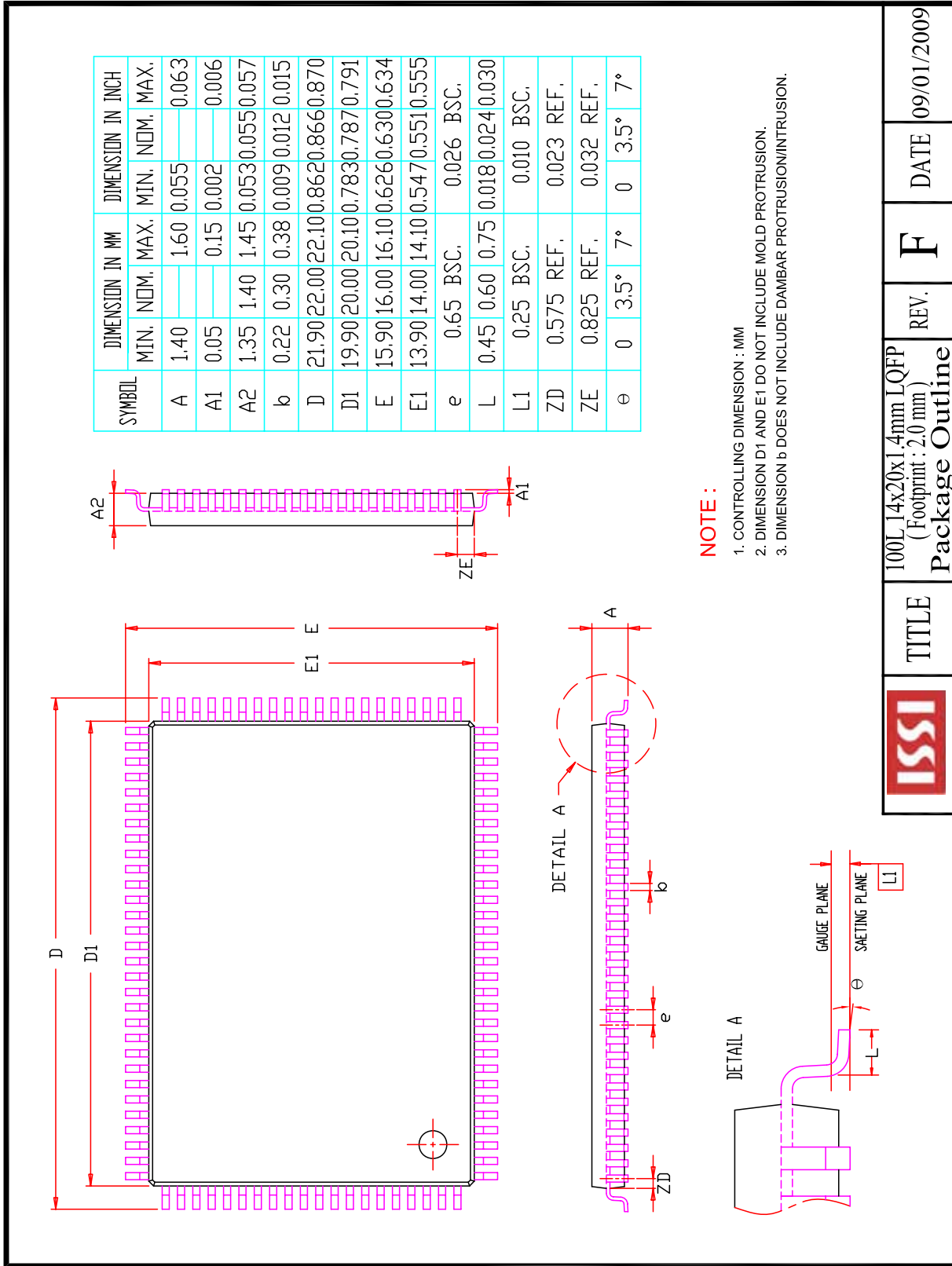

|  |       |  |        |                 |
|--|-------|--|--------|-----------------|
|  | TITLE | 100L 14x20x1.4mm LQFP<br>(Footprint : 2.0 mm)<br>Package Outline | REV. F | DATE 09/01/2009 |
|--|-------|--|--------|-----------------|

280-600-011 REV. A

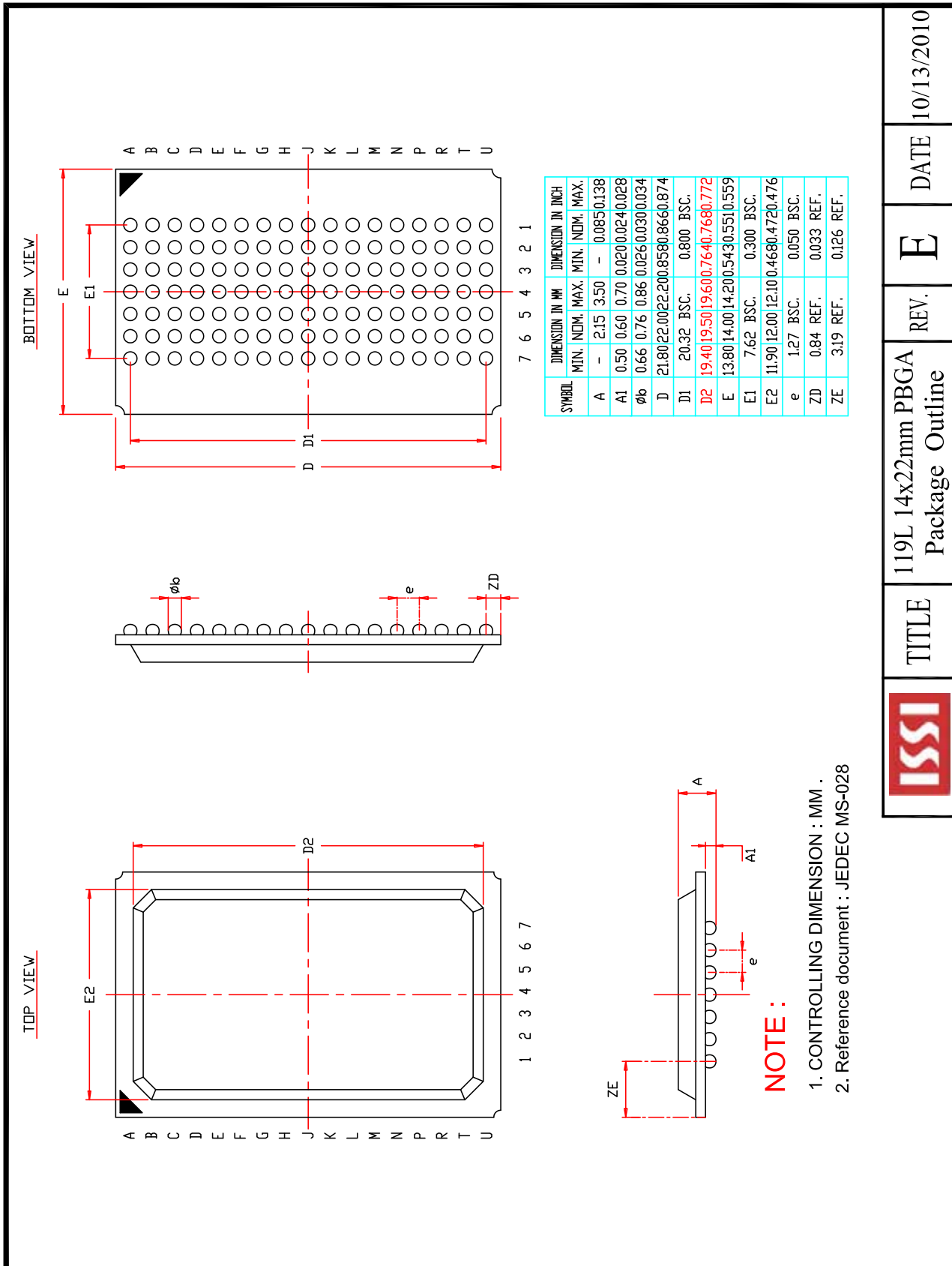

|  |                                      |      |            |
|--|--------------------------------------|------|------------|
|  | TITLE                                | REV. | DATE       |
|  | 119L 14x22mm PBGA<br>Package Outline | E    | 10/13/2010 |

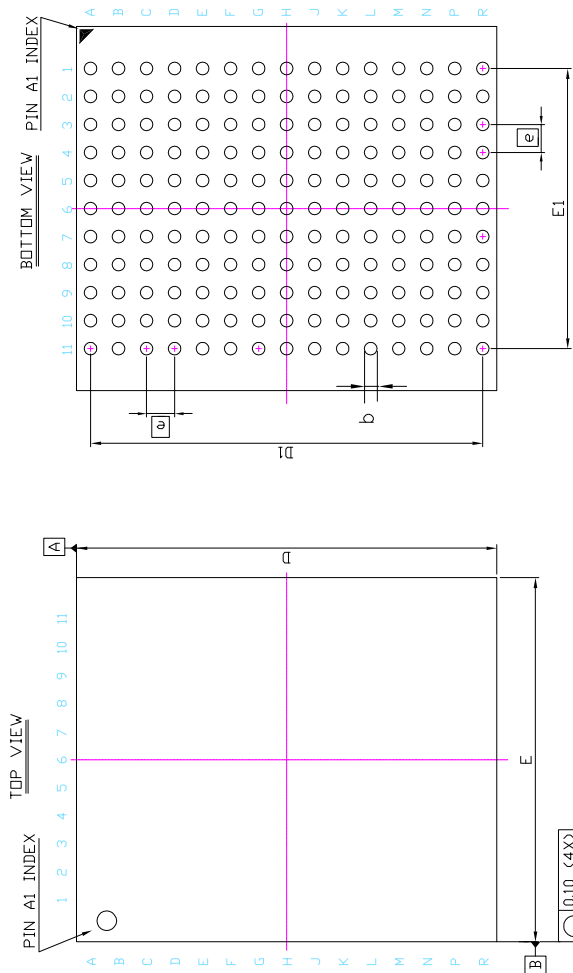

| SYM.      | DIMENSION (mm) |       |       | DIMENSION (inch) |       |       |
|-----------|----------------|-------|-------|------------------|-------|-------|
|           | MIN.           | NOM.  | MAX.  | MIN.             | NOM.  | MAX.  |
| A         | —              | —     | 1.20  | —                | —     | 0.047 |
| A1        | 0.25           | 0.35  | 0.40  | 0.010            | 0.014 | 0.016 |
| A2        | —              | 0.79  | —     | —                | 0.031 | —     |
| b         | 0.40           | 0.45  | 0.50  | 0.016            | 0.018 | 0.020 |
| D         | 14.90          | 15.00 | 15.10 | 0.587            | 0.591 | 0.594 |
| DI        | 13.90          | 14.00 | 14.10 | 0.547            | 0.551 | 0.555 |
| E         | 12.90          | 13.00 | 13.10 | 0.508            | 0.512 | 0.516 |
| E1        | 9.90           | 10.00 | 10.10 | 0.390            | 0.394 | 0.398 |
| $\bar{E}$ | 1.00 BSC       |       |       | 0.039 BSC        |       |       |

**NOTE :**

1. CONTROLLING DIMENSION : MM .

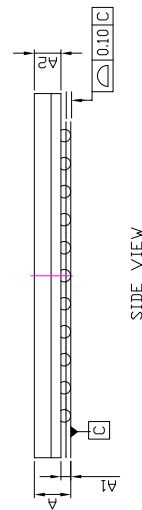

|  |       |  |        |                 |
|--|-------|--|--------|-----------------|
|  | TITLE | 165L 13x15mm TF-BGA<br>Package Outline | REV. B | DATE 08/28/2008 |
|--|-------|--|--------|-----------------|

## Данный компонент на территории Российской Федерации

### Вы можете приобрести в компании MosChip.

Для оперативного оформления запроса Вам необходимо перейти по данной ссылке:

<http://moschip.ru/get-element>

Вы можете разместить у нас заказ для любого Вашего проекта, будь то серийное производство или разработка единичного прибора.

В нашем ассортименте представлены ведущие мировые производители активных и пассивных электронных компонентов.

Нашей специализацией является поставка электронной компонентной базы двойного назначения, продукции таких производителей как XILINX, Intel (ex.ALTERA), Vicor, Microchip, Texas Instruments, Analog Devices, Mini-Circuits, Amphenol, Glenair.

Сотрудничество с глобальными дистрибьюторами электронных компонентов, предоставляет возможность заказывать и получать с международных складов практически любой перечень компонентов в оптимальные для Вас сроки.

На всех этапах разработки и производства наши партнеры могут получить квалифицированную поддержку опытных инженеров.

Система менеджмента качества компании отвечает требованиям в соответствии с ГОСТ Р ИСО 9001, ГОСТ РВ 0015-002 и ЭС РД 009

### Офис по работе с юридическими лицами:

105318, г.Москва, ул.Щербаковская д.3, офис 1107, 1118, ДЦ «Щербаковский»

Телефон: +7 495 668-12-70 (многоканальный)

Факс: +7 495 668-12-70 (доб.304)

E-mail: [info@moschip.ru](mailto:info@moschip.ru)

Skype отдела продаж:

moschip.ru

moschip.ru\_4

moschip.ru\_6

moschip.ru\_9