

1SMB5.0CA
THRU
1SMB170CA

SURFACE MOUNT
BI-DIRECTIONAL
GLASS PASSIVATED JUNCTION
SILICON TRANSIENT
VOLTAGE SUPPRESSOR
600 WATTS, 5.0 THRU 170 VOLTS

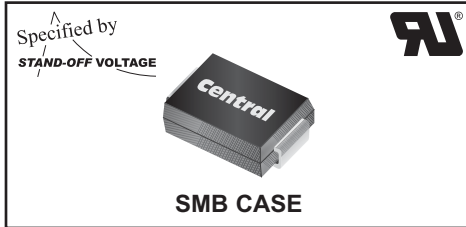

www.centrasemi.com



DESCRIPTION:

The CENTRAL SEMICONDUCTOR 1SMB5.0CA Series types are Surface Mount Bi-Directional Glass Passivated Junction Transient Voltage Suppressors designed to protect voltage sensitive components from high voltage transients.

THIS DEVICE IS MANUFACTURED WITH A GLASS PASSIVATED CHIP FOR OPTIMUM RELIABILITY.

Note: For Uni-directional devices, please refer to the 1SMB5.0A Series data sheet.

MARKING CODE: SEE ELECTRICAL CHARACTERISTICS TABLE

• This series is UL listed, UL file number E130224

MAXIMUM RATINGS: ($T_A=25^\circ\text{C}$ unless otherwise noted)

Peak Power Dissipation (Note 1)

Operating and Storage Junction Temperature

SYMBOL

P_{PK} 600

T_J, T_{stg} -65 to +150

UNITS

W

$^\circ\text{C}$

ELECTRICAL CHARACTERISTICS: ($T_A=25^\circ\text{C}$ unless otherwise noted)

TYPE	REVERSE STAND-OFF VOLTAGE	BREAKDOWN VOLTAGE		TEST CURRENT	MAXIMUM REVERSE LEAKAGE CURRENT	MAXIMUM CLAMPING VOLTAGE	PEAK PULSE CURRENT (Note 1)	MARKING CODE
	V_{RWM}	$V_{BR} @ I_T$		I_T	$I_R @ V_{RWM}$	$V_C @ I_{pp}$	I_{pp}	
	V	MIN V	MAX V	mA	μA	V	A	
1SMB5.0CA	5.0	6.40	7.25	10	1600	9.2	65.2	CKEC
1SMB6.0CA	6.0	6.67	7.67	10	1600	10.3	58.3	CKGC
1SMB6.5CA	6.5	7.22	8.30	10	1000	11.2	53.6	CKKC
1SMB7.0CA	7.0	7.78	8.95	10	400	12	50	CKMC
1SMB7.5CA	7.5	8.33	9.58	1.0	200	12.9	46.5	CKPC
1SMB8.0CA	8.0	8.89	10.23	1.0	100	13.6	44.1	CKRC
1SMB8.5CA	8.5	9.44	10.82	1.0	20	14.4	41.7	CKTC
1SMB9.0CA	9.0	10	11.5	1.0	10	15.4	39	CKVC
1SMB10CA	10	11.1	12.8	1.0	5.0	17	35.3	CKXC
1SMB11CA	11	12.2	14	1.0	5.0	18.2	33	CKZC
1SMB12CA	12	13.3	15.3	1.0	5.0	19.9	30.2	CLEC
1SMB13CA	13	14.4	16.5	1.0	5.0	21.5	27.9	CLGC
1SMB14CA	14	15.6	17.9	1.0	5.0	23.2	25.8	CLKC
1SMB15CA	15	16.7	19.2	1.0	5.0	24.4	24	CLMC
1SMB16CA	16	17.8	20.5	1.0	5.0	26	23.1	CLPC
1SMB17CA	17	18.9	21.7	1.0	5.0	27.6	21.7	CLRC
1SMB18CA	18	20	23.3	1.0	5.0	29.2	20.5	CLTC
1SMB20CA	20	22.2	25.5	1.0	5.0	32.4	18.5	CLVC
1SMB22CA	22	24.4	28	1.0	5.0	35.5	16.9	CLXC
1SMB24CA	24	26.7	30.7	1.0	5.0	38.9	15.4	CLZC
1SMB26CA	26	28.9	33.2	1.0	5.0	42.1	14.2	CMEC
1SMB28CA	28	31.1	35.8	1.0	5.0	45.4	13.2	CMGC
1SMB30CA	30	33.3	38.3	1.0	5.0	48.4	12.4	CMKC

Notes: (1) Non-repetitive 10x1,000 μs pulse.

R5 (8-September 2011)

**1SMB5.0CA
THRU
1SMB170CA**

**SURFACE MOUNT
BI-DIRECTIONAL
GLASS PASSIVATED JUNCTION
SILICON TRANSIENT
VOLTAGE SUPPRESSOR
600 WATTS, 5.0 THRU 170 VOLTS**



ELECTRICAL CHARACTERISTICS - Continued: ($T_A=25^{\circ}\text{C}$ unless otherwise noted)

TYPE	REVERSE STAND-OFF VOLTAGE	BREAKDOWN VOLTAGE		TEST CURRENT	MAXIMUM REVERSE LEAKAGE CURRENT	MAXIMUM CLAMPING VOLTAGE	PEAK PULSE CURRENT	MARKING CODE
	V_{RWM}	$V_{BR} @ I_T$		I_T	$I_R @ V_{RWM}$	$V_C @ I_{PP}$	(Note 1) I_{PP}	
	V	MIN V	MAX V	mA	μA	V	A	
1SMB33CA	33	36.7	42.2	1.0	5.0	53.3	11.3	CMMC
1SMB36CA	36	40	46	1.0	5.0	58.1	10.3	CMPC
1SMB40CA	40	44.4	51.1	1.0	5.0	64.5	9.3	CMRC
1SMB43CA	43	47.8	54.9	1.0	5.0	69.4	8.6	CMTC
1SMB45CA	45	50	57.5	1.0	5.0	72.7	8.3	CMVC
1SMB48CA	48	53.3	61.3	1.0	5.0	77.4	7.7	CMXC
1SMB51CA	51	56.7	65.2	1.0	5.0	82.4	7.3	CMZC
1SMB54CA	54	60	69	1.0	5.0	87.1	6.9	CNEC
1SMB58CA	58	64.4	74.1	1.0	5.0	93.6	6.4	CNGC
1SMB60CA	60	66.7	76.7	1.0	5.0	96.8	6.2	CNKC
1SMB64CA	64	71.1	81.8	1.0	5.0	103	5.8	CNMC
1SMB70CA	70	77.8	89.5	1.0	5.0	113	5.3	CNPC
1SMB75CA	75	83.3	95.8	1.0	5.0	121	4.9	CNRC
1SMB78CA	78	86.7	99.7	1.0	5.0	126	4.7	CNTC
1SMB85CA	85	94.4	108.2	1.0	5.0	137	4.4	CNVC
1SMB90CA	90	100	115.5	1.0	5.0	146	4.1	CNXC
1SMB100CA	100	111	128	1.0	5.0	162	3.7	CNZC
1SMB110CA	110	122	140.5	1.0	5.0	177	3.4	CPEC
1SMB120CA	120	133	153	1.0	5.0	193	3.1	CPGC
1SMB130CA	130	144	165.5	1.0	5.0	209	2.9	CPKC
1SMB150CA	150	167	192.5	1.0	5.0	243	2.5	CPMC
1SMB160CA	160	178	205	1.0	5.0	259	2.3	CPPC
1SMB170CA	170	189	217.5	1.0	5.0	275	2.2	CPRC

SMB CASE - MECHANICAL OUTLINE

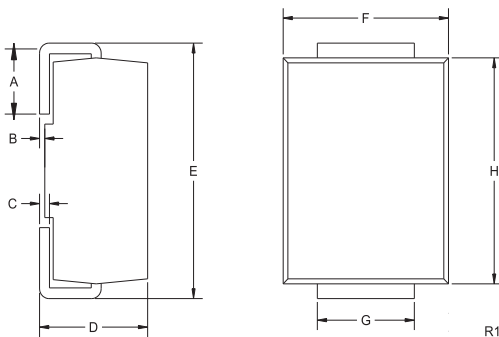

SYMBOL	DIMENSIONS			
	INCHES		MILLIMETERS	
A	0.030	0.060	0.76	1.52
B	0.004	0.008	0.10	0.20
C	0.006	0.012	0.15	0.30
D	0.086	0.096	2.18	2.44
E	0.200	0.220	5.08	5.59
F	0.130	0.150	3.30	3.81
G	0.077	0.083	1.96	2.11
H	0.160	0.180	4.06	4.57

SMB (REV: R1)

R5 (8-September 2011)

1SMB5.0CA
 THRU
 1SMB170CA



SURFACE MOUNT
 BI-DIRECTIONAL
 GLASS PASSIVATED JUNCTION
 SILICON TRANSIENT
 VOLTAGE SUPPRESSOR
 600 WATTS, 5.0 THRU 170 VOLTS



TYPICAL ELECTRICAL CHARACTERISTICS

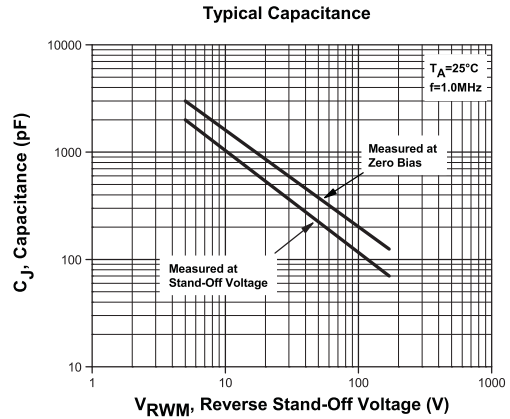
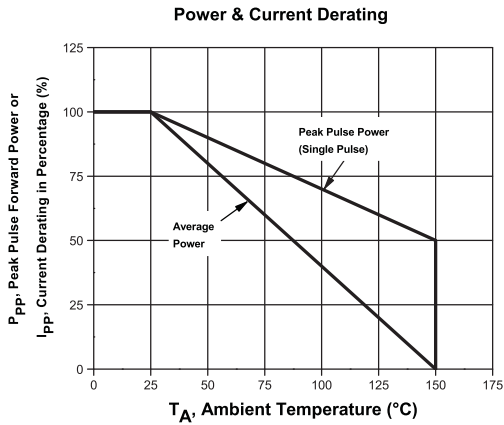
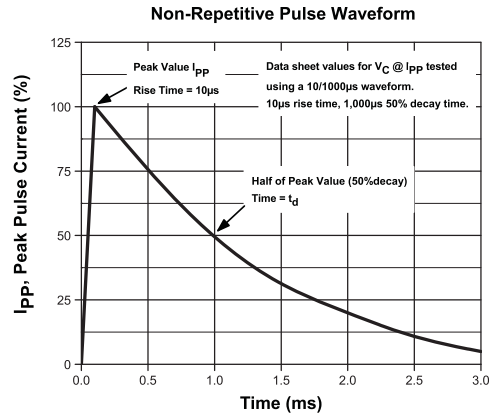
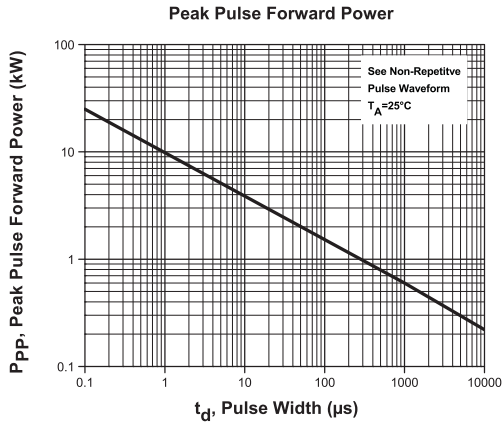

R5 (8-September 2011)

Данный компонент на территории Российской Федерации

Вы можете приобрести в компании MosChip.

Для оперативного оформления запроса Вам необходимо перейти по данной ссылке:

<http://moschip.ru/get-element>

Вы можете разместить у нас заказ для любого Вашего проекта, будь то серийное производство или разработка единичного прибора.

В нашем ассортименте представлены ведущие мировые производители активных и пассивных электронных компонентов.

Нашей специализацией является поставка электронной компонентной базы двойного назначения, продукции таких производителей как XILINX, Intel (ex.ALTERA), Vicor, Microchip, Texas Instruments, Analog Devices, Mini-Circuits, Amphenol, Glenair.

Сотрудничество с глобальными дистрибьюторами электронных компонентов, предоставляет возможность заказывать и получать с международных складов практически любой перечень компонентов в оптимальные для Вас сроки.

На всех этапах разработки и производства наши партнеры могут получить квалифицированную поддержку опытных инженеров.

Система менеджмента качества компании отвечает требованиям в соответствии с ГОСТ Р ИСО 9001, ГОСТ РВ 0015-002 и ЭС РД 009

Офис по работе с юридическими лицами:

105318, г.Москва, ул.Щербаковская д.3, офис 1107, 1118, ДЦ «Щербаковский»

Телефон: +7 495 668-12-70 (многоканальный)

Факс: +7 495 668-12-70 (доб.304)

E-mail: info@moschip.ru

Skype отдела продаж:

moschip.ru

moschip.ru_4

moschip.ru_6

moschip.ru_9