

MECHANICAL DATA

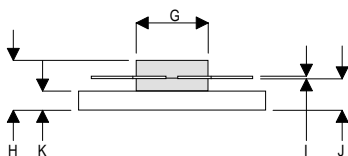
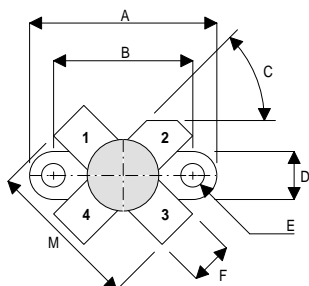

DA

PIN 1 SOURCE PIN 2 DRAIN
 PIN 3 SOURCE PIN 4 GATE

DIM	mm	Tol.	Inches	Tol.
A	24.76	0.13	0.975	0.005
B	18.42	0.13	0.725	0.005
C	45°	5°	45°	5°
D	6.35	0.13	0.25	0.005
E	3.17	0.13	0.125 DIA	0.005
F	5.71	0.13	0.225	0.005
G	9.52	0.13	0.375	0.005
H	6.60	REF	0.260	REF
I	0.13	0.02	0.005	0.001
J	4.32	0.13	0.170	0.005
K	2.54	0.13	0.100	0.005
M	20.32	0.25	0.800	0.010

**GOLD METALLISED
 MULTI-PURPOSE SILICON
 DMOS RF FET
 20W – 28V – 175MHz
 SINGLE ENDED**

FEATURES

- SIMPLIFIED AMPLIFIER DESIGN
- SUITABLE FOR BROAD BAND APPLICATIONS
- LOW C_{rss}
- SIMPLE BIAS CIRCUITS
- LOW NOISE
- HIGH GAIN – 16 dB MINIMUM

APPLICATIONS

- HF/VHF/UHF COMMUNICATIONS
 from 1 MHz to 175 MHz

ABSOLUTE MAXIMUM RATINGS ($T_{case} = 25^{\circ}C$ unless otherwise stated)

P_D	Power Dissipation	50W
BV_{DSS}	Drain – Source Breakdown Voltage	70V
BV_{GSS}	Gate – Source Breakdown Voltage	$\pm 20V$
$I_{D(sat)}$	Drain Current	5A
T_{stg}	Storage Temperature	-65 to 150°C
T_j	Maximum Operating Junction Temperature	200°C

Semelab Plc reserves the right to change test conditions, parameter limits and package dimensions without notice. Information furnished by Semelab is believed to be both accurate and reliable at the time of going to press. However Semelab assumes no responsibility for any errors or omissions discovered in its use. Semelab encourages customers to verify that datasheets are current before placing orders.

ELECTRICAL CHARACTERISTICS (T_{case} = 25°C unless otherwise stated)

Parameter	Test Conditions	Min.	Typ.	Max.	Unit
B _V DSS Drain–Source Breakdown Voltage	V _{GS} = 0 I _D = 100mA	70			V
I _D DSS Zero Gate Voltage Drain Current	V _{DS} = 28V V _{GS} = 0			1	mA
I _G DSS Gate Leakage Current	V _{GS} = 20V V _{DS} = 0			1	μA
V _{GS(th)} Gate Threshold Voltage*	I _D = 10mA V _{DS} = V _{GS}	1		7	V
g _{fs} Forward Transconductance*	V _{DS} = 10V I _D = 1A	0.8			S
G _{PS} Common Source Power Gain	P _O = 20W	16			dB
η Drain Efficiency	V _{DS} = 28V I _{DQ} = 0.1A	50			%
VSWR Load Mismatch Tolerance	f = 175MHz	20:1			—
C _{iss} Input Capacitance	V _{DS} = 28V V _{GS} = -5V f = 1MHz			60	pF
C _{oss} Output Capacitance	V _{DS} = 28V V _{GS} = 0 f = 1MHz			30	pF
C _{rss} Reverse Transfer Capacitance	V _{DS} = 28V V _{GS} = 0 f = 1MHz			2.5	pF
R _{dson} Saturation Resistance	V _{GS} = 20V I _{DS} = 2.5A		1		Ω

* Pulse Test: Pulse Duration = 300 μs , Duty Cycle ≤ 2%

HAZARDOUS MATERIAL WARNING

The ceramic portion of the device between leads and metal flange is beryllium oxide. Beryllium oxide dust is highly toxic and care must be taken during handling and mounting to avoid damage to this area.

THESE DEVICES MUST NEVER BE THROWN AWAY WITH GENERAL INDUSTRIAL OR DOMESTIC WASTE.

THERMAL DATA

R _{THj-case}	Thermal Resistance Junction – Case	Max. 3.5°C / W
-----------------------	------------------------------------	----------------

Semelab Plc reserves the right to change test conditions, parameter limits and package dimensions without notice. Information furnished by Semelab is believed to be both accurate and reliable at the time of going to press. However Semelab assumes no responsibility for any errors or omissions discovered in its use. Semelab encourages customers to verify that datasheets are current before placing orders.

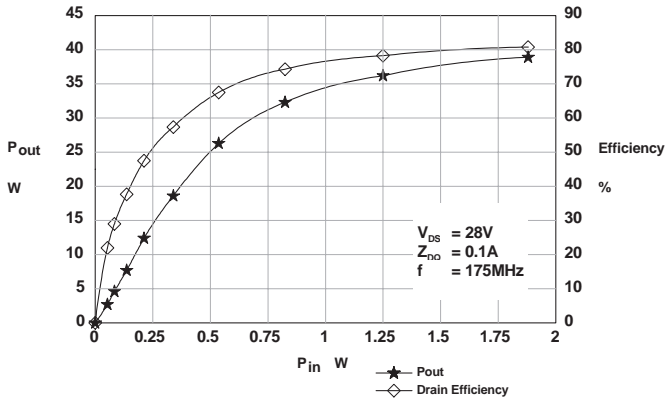

Figure 1 – Power Output and Efficiency vs. Power Input.

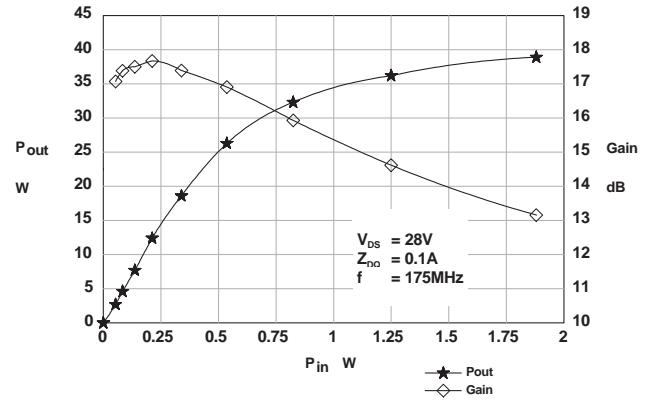

Figure 2 – Power Output & Gain vs. Power Input.

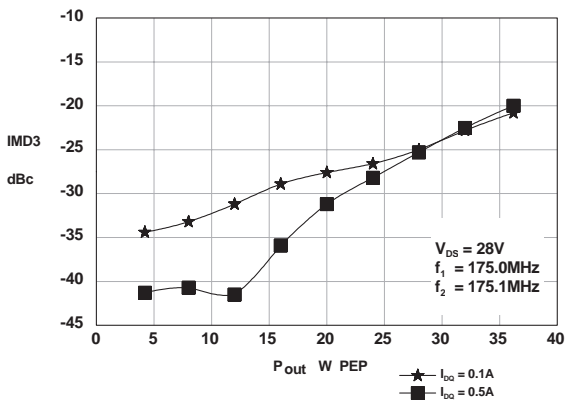

Figure 3 – IMD vs. Output Power.

D1001UK
OPTIMUM SOURCE AND LOAD IMPEDANCE

Frequency MHz	Z _S Ω	Z _L Ω
175MHz	5 + j14	12 - j14

Typical S Parameters

! V_{DS} = 28V, I_{DQ} = 0.1A
MHZ S MA R 50

!Freq MHz	S11 mag ang	S21 mag ang	S12 mag ang	S22 mag ang
50	0.780 -116	18 112	0.034 25	0.642 -85
100	0.775 -135	9.312 85	0.030 11	0.577 -103
150	0.795 -149	6.077 68	0.022 14	0.613 -116
200	0.826 -159	4.193 53	0.017 44	0.669 -128
250	0.853 -169	3.216 43	0.023 74	0.715 -139
300	0.878 -179	2.566 35	0.039 89	0.759 -150
350	0.903 171	1.991 23	0.052 86	0.801 -161
400	0.923 161	1.655 18	0.070 84	0.839 -173
450	0.944 151	1.322 9	0.080 80	0.878 177
500	0.963 142	1.121 4	0.098 76	0.914 167
550	0.978 136	0.899 -2	0.108 72	0.945 159
600	0.985 131	0.762 -7	0.119 66	0.966 153

Semelab Plc reserves the right to change test conditions, parameter limits and package dimensions without notice. Information furnished by Semelab is believed to be both accurate and reliable at the time of going to press. However Semelab assumes no responsibility for any errors or omissions discovered in its use. Semelab encourages customers to verify that datasheets are current before placing orders.

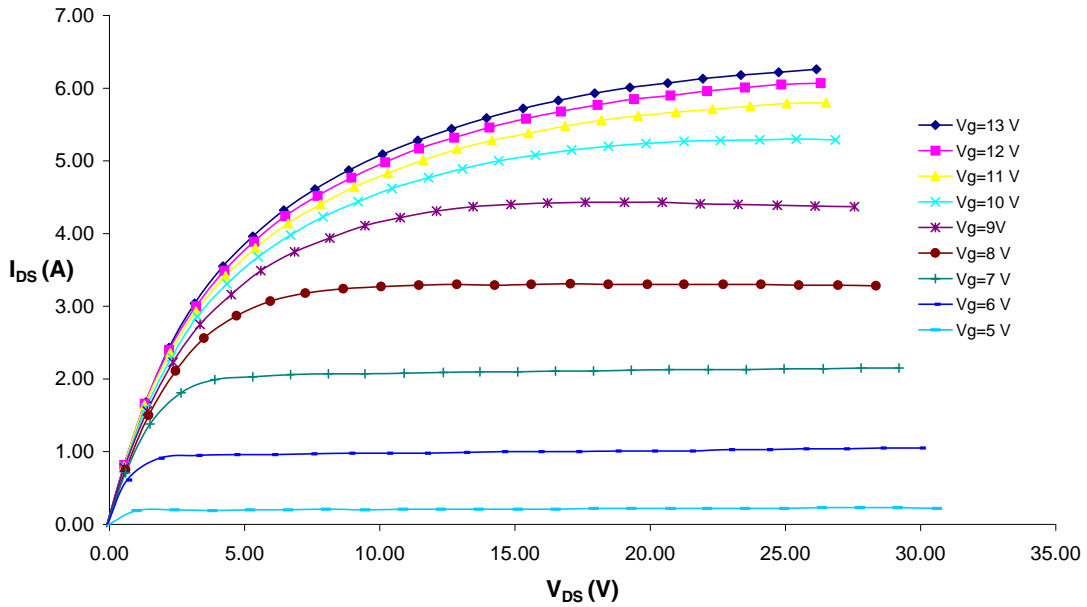

Figure 4 – Typical IV Characteristics.

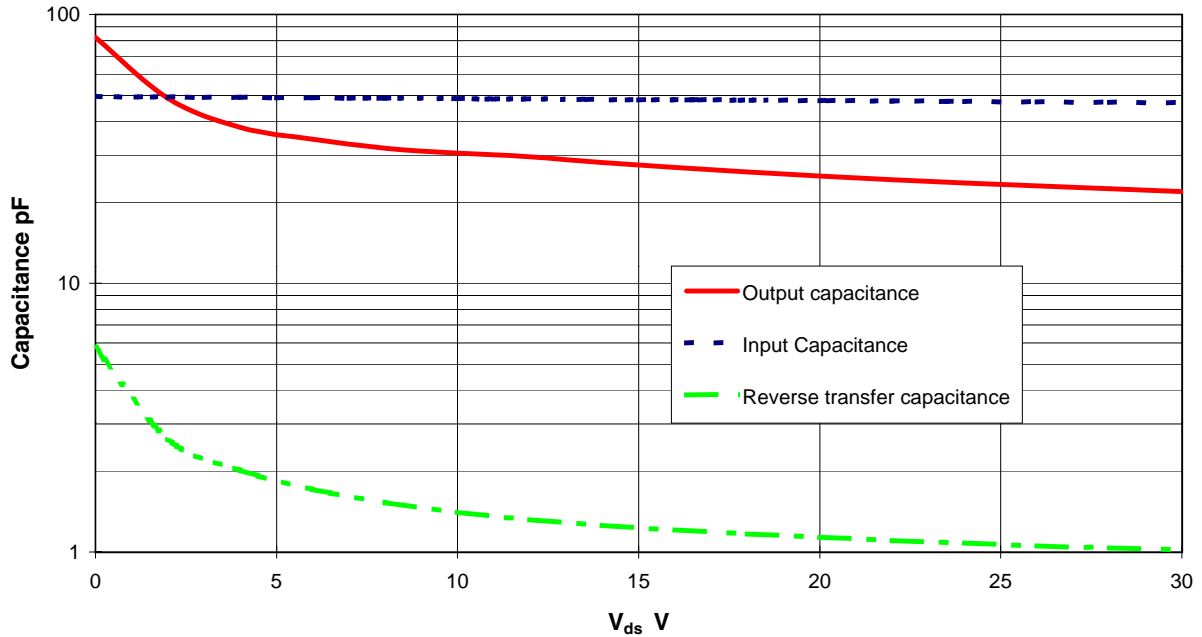
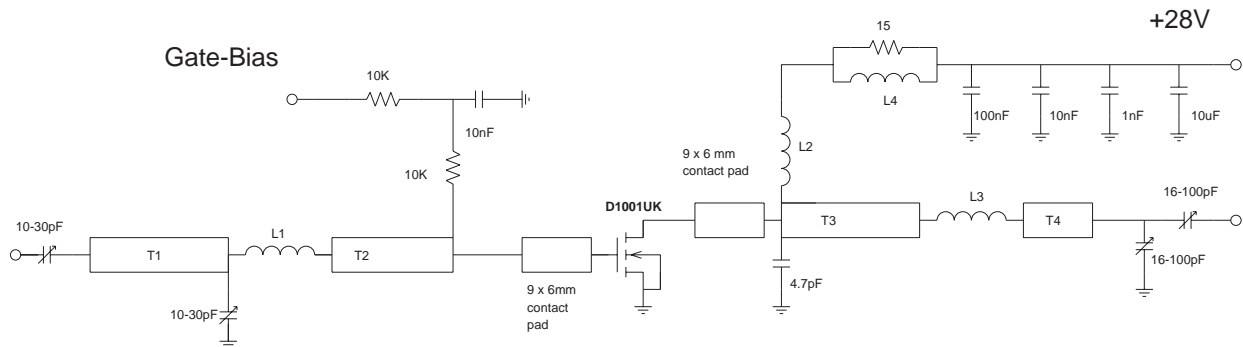

Figure 5 – Typical CV Characteristics.

Semelab Plc reserves the right to change test conditions, parameter limits and package dimensions without notice. Information furnished by Semelab is believed to be both accurate and reliable at the time of going to press. However Semelab assumes no responsibility for any errors or omissions discovered in its use. Semelab encourages customers to verify that datasheets are current before placing orders.



D1001UK 175MHz TEST FIXTURE

Substrate 1.6mm PTFE/glass, Er=2.5
All microstrip lines W=4.4mm

T1	10mm	L1	1.5 turns 22swg enamelled copper wire, 6mm i.d.
T2	13mm	L2	10 turns 19swg enamelled copper wire, 6mm i.d.
T3	12mm	L3	1.5 turns 22swg enamelled copper wire, 6mm i.d.
T4	4mm	L4	13.5 turns 19swg enamelled copper wire on Siemens B64920A618X830 ferrite core

Mouser Electronics

Authorized Distributor

Click to View Pricing, Inventory, Delivery & Lifecycle Information:

[TT Electronics:](#)

[D1001UK](#)

Данный компонент на территории Российской Федерации

Вы можете приобрести в компании MosChip.

Для оперативного оформления запроса Вам необходимо перейти по данной ссылке:

<http://moschip.ru/get-element>

Вы можете разместить у нас заказ для любого Вашего проекта, будь то серийное производство или разработка единичного прибора.

В нашем ассортименте представлены ведущие мировые производители активных и пассивных электронных компонентов.

Нашей специализацией является поставка электронной компонентной базы двойного назначения, продукции таких производителей как XILINX, Intel (ex.ALTERA), Vicor, Microchip, Texas Instruments, Analog Devices, Mini-Circuits, Amphenol, Glenair.

Сотрудничество с глобальными дистрибьюторами электронных компонентов, предоставляет возможность заказывать и получать с международных складов практически любой перечень компонентов в оптимальные для Вас сроки.

На всех этапах разработки и производства наши партнеры могут получить квалифицированную поддержку опытных инженеров.

Система менеджмента качества компании отвечает требованиям в соответствии с ГОСТ Р ИСО 9001, ГОСТ РВ 0015-002 и ЭС РД 009

Офис по работе с юридическими лицами:

105318, г.Москва, ул.Щербаковская д.3, офис 1107, 1118, ДЦ «Щербаковский»

Телефон: +7 495 668-12-70 (многоканальный)

Факс: +7 495 668-12-70 (доб.304)

E-mail: info@moschip.ru

Skype отдела продаж:

moschip.ru

moschip.ru_4

moschip.ru_6

moschip.ru_9