

Chip Beads

For signal line

MMZ series

| | | |
|-------|------------------|--------------------------|
| Type: | MMZ0402 | 0402[01005 inch]* |
| | MMZ0603 | 0603[0201 inch] |
| | MMZ1005 | 1005[0402 inch] |
| | MMZ1608 | 1608[0603 inch] |
| | MMZ2012 | 2012[0805 inch] |
| | MMZ0603-E | 0603[0201 inch] |
| | MMZ1005-E | 1005[0402 inch] |

* Dimensions Code JIS[EIA]

Issue date: March 2013

- All specifications are subject to change without notice.
- Conformity to RoHS Directive: This means that, in conformity with EU Directive 2002/95/EC, lead, cadmium, mercury, hexavalent chromium, and specific bromine-based flame retardants, PBB and PBDE, have not been used, except for exempted applications.

Chip Beads For Signal Line

Conformity to RoHS Directive

MMZ Series MMZ0402

FEATURES

- It is super small size(L0.4×W0.2×T0.2mm).
- It prevents radiated noise from high-speed signal lines.
- Maintain impedance to high frequency band.
- Because it adopts silver in internal electrode, it is low DC resistance.
- Because it is not generate of cross talk with closed magnetic circuit structural design, high density assembly is possible.
- It is a product conforming to RoHS directive.

APPLICATIONS

Removal of signal line noises of cellular phones, portable audio players, various modules, etc.

PRODUCT IDENTIFICATION

MMZ 0402 S 121 C T
 (1) (2) (3) (4) (5) (6) (7)

- (1) Series name
 (2) Dimensions L×W
 (3) Type name
 (4) Impedance
 121:120Ω at 100MHz
 (5) Characteristic type
 (6) Packaging style
 T: Taping
 (7) TDK internal code

HANDLING AND PRECAUTIONS

- Before soldering, be sure to preheat components. The preheating temperature should be set so that the temperature difference between the solder temperature and product temperature does not exceed 150°C.
- After mounting components onto the printed circuit board, do not apply stress through board bending or mishandling.
- Do not expose the inductors to stray magnetic fields.
- Avoid static electricity discharge during handling.

SHAPES AND DIMENSIONS/RECOMMENDED PC BOARD PATTERN



SPECIFICATIONS

| | |
|-----------------------------|----------------------------|
| Operating temperature range | -55 to +125°C |
| Storage temperature range | -55 to +125°C(After mount) |

PACKAGING STYLE AND QUANTITIES

| | |
|-----------------|-------------------|
| Packaging style | Quantity |
| Taping | 20000 pieces/reel |

RECOMMENDED SOLDERING CONDITION

REFLOW SOLDERING

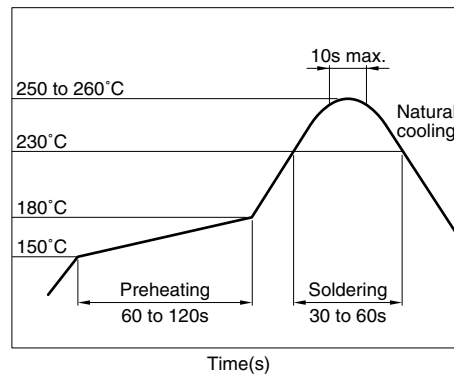

ELECTRICAL CHARACTERISTICS

| Part No. | Impedance (Ω)[100MHz]* | DC resistance (Ω)max. | Rated current (mA)max. |
|--------------|------------------------|-----------------------|------------------------|
| MMZ0402S100C | 10±5Ω | 0.10 | 500 |
| MMZ0402S700C | 70±25% | 0.45 | 260 |
| MMZ0402S121C | 120±25% | 0.70 | 210 |
| MMZ0402S151C | 150±25% | 0.70 | 200 |

* Test equipment: E4991A or equivalent
 Test tool: 16197 or equivalent
 Test temperature: 25±10°C

• Conformity to RoHS Directive: This means that, in conformity with EU Directive 2002/95/EC, lead, cadmium, mercury, hexavalent chromium, and specific bromine-based flame retardants, PBB and PBDE, have not been used, except for exempted applications.

• Please contact our Sales office when your application is considered the following:
 The device's failure or malfunction may directly endanger human life (e.g. application for automobile/aircraft/medical/nuclear power devices, etc.)

• All specifications are subject to change without notice.

TYPICAL ELECTRICAL CHARACTERISTICS
Z FREQUENCY CHARACTERISTICS(DIFFERS ACCORDING TO SERIES)
MMZ0402S SERIES



Z, X, R vs. FREQUENCY CHARACTERISTICS
MMZ0402S100C



MMZ0402S700C



MMZ0402S121C



MMZ0402S151C



PACKAGING STYLES
REEL DIMENSIONS



TAPE DIMENSIONS



• All specifications are subject to change without notice.

Chip Beads For Signal Line

Conformity to RoHS Directive

MMZ Series MMZ0603

FEATURES

- This is a multilayered chip bead product with dimensions of L0.6×W0.3×T0.3mm.
- The product is magnetically shielded, allowing high density mounting.
- We refined the rules for internal conductor design to reduce floating capacity between conductors, which in turn has contributed to a dramatic improvement in high frequency characteristics. We have also been able to expand and reinforce the EMI suppression in the GHz range.
- It is a product conforming to RoHS directive.

APPLICATIONS

Removal of signal line noises of cellular phones, portable audio players, various modules, DSCs, portable game machines, etc.

PRODUCT IDENTIFICATION

| | | | | | | |
|-----|------|-----|-----|-----|-----|-----|
| MMZ | 0603 | S | 121 | C | T | □□□ |
| (1) | (2) | (3) | (4) | (5) | (6) | (7) |

- (1) Series name
- (2) Dimensions L×W
- (3) Type name
- (4) Impedance
121:120Ω at 100MHz
- (5) Characteristic type
- (6) Packaging style
T:Taping
- (7) TDK internal code

HANDLING AND PRECAUTIONS

- Before soldering, be sure to preheat components. The preheating temperature should be set so that the temperature difference between the solder temperature and product temperature does not exceed 150°C.
- After mounting components onto the printed circuit board, do not apply stress through board bending or mishandling.
- Do not expose the inductors to stray magnetic fields.
- Avoid static electricity discharge during handling.
- When hand soldering, apply the soldering iron to the printed circuit board only. Temperature of the iron tip should not exceed 350°C. Soldering time should not exceed 3 seconds.

MATERIAL CHARACTERISTICS

S material: Standard type that features impedance characteristics similar to those of a typical ferrite core.

For signal line applications in which the blocking region is near 100MHz. Impedance values selected for effectiveness at 40 to 300MHz.

Y material: High frequency range type intended for the 100MHz region and above.

For signal line applications in which the signal frequency is far from the cutoff frequency. Impedance values selected for effectiveness at 80 to 400MHz.

D material: For applications calling for low insertion loss at low frequencies and sharply increasing impedance at high frequencies. Designed for high impedance at high frequencies (300MHz to 1GHz) for signal line applications.

F material: This new product inherits the characteristic of our D-material, namely its sharp impedance rise time, and its impedance peak frequency has been shifted higher into range. The product offers excellent noise suppression from 600MHz to as high as in the GHz range.

TYPICAL MATERIAL CHARACTERISTICS



• Conformity to RoHS Directive: This means that, in conformity with EU Directive 2002/95/EC, lead, cadmium, mercury, hexavalent chromium, and specific bromine-based flame retardants, PBB and PBDE, have not been used, except for exempted applications.

• Please contact our Sales office when your application is considered the following:
The device's failure or malfunction may directly endanger human life (e.g. application for automobile/aircraft/medical/nuclear power devices, etc.)

• All specifications are subject to change without notice.

SHAPES AND DIMENSIONS/RECOMMENDED PC BOARD PATTERN



SPECIFICATIONS

| | |
|-----------------------------|----------------------------|
| Operating temperature range | -55 to +125°C |
| Storage temperature range | -55 to +125°C(After mount) |

PACKAGING STYLE AND QUANTITIES

| | |
|-----------------|-------------------|
| Packaging style | Quantity |
| Taping | 15000 pieces/reel |

RECOMMENDED SOLDERING CONDITION REFLOW SOLDERING



ELECTRICAL CHARACTERISTICS

| Part No. | Impedance (Ω)[100MHz]* | DC resistance (Ω)max. | Rated current (mA)max. |
|--------------|------------------------|-----------------------|------------------------|
| MMZ0603S100C | 10±5% | 0.09 | 500 |
| MMZ0603S800C | 80±25% | 0.30 | 200 |
| MMZ0603S121C | 120±25% | 0.45 | 200 |
| MMZ0603S241C | 240±25% | 0.57 | 200 |
| MMZ0603S471C | 470±25% | 1.30 | 100 |
| MMZ0603S601C | 600±25% | 1.45 | 100 |
| MMZ0603S102H | 1000±25% | 1.25 | 200 |
| MMZ0603Y750C | 75±25% | 0.35 | 300 |
| MMZ0603Y121C | 120±25% | 0.39 | 200 |
| MMZ0603Y241C | 240±25% | 0.80 | 200 |
| MMZ0603Y471C | 470±25% | 1.40 | 200 |
| MMZ0603Y601C | 600±25% | 1.50 | 200 |
| MMZ0603D330C | 33±25% | 0.70 | 200 |
| MMZ0603D470C | 47±25% | 0.70 | 200 |
| MMZ0603D560C | 56±25% | 0.95 | 100 |
| MMZ0603D800C | 80±25% | 1.25 | 100 |
| MMZ0603D121C | 120±25% | 1.40 | 100 |
| MMZ0603F100C | 10±5% | 0.50 | 200 |
| MMZ0603F220C | 22±25% | 1.00 | 200 |
| MMZ0603F330C | 33±25% | 1.30 | 150 |

* Test equipment: E4991A or equivalent
Test tool: 16197 or equivalent
Test temperature: 25±10°C

TYPICAL ELECTRICAL CHARACTERISTICS

Z FREQUENCY CHARACTERISTICS(DIFFERS ACCORDING TO SERIES)

MMZ0603S SERIES



MMZ0603Y SERIES

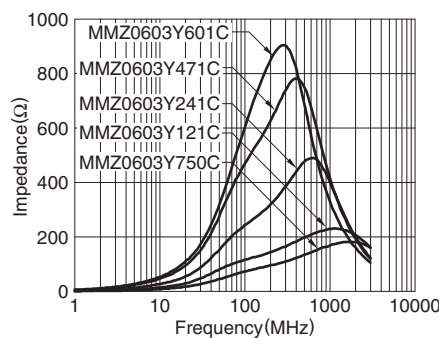

MMZ0603D SERIES



MMZ0603F SERIES



• All specifications are subject to change without notice.

TYPICAL ELECTRICAL CHARACTERISTICS

Z, X, R vs. FREQUENCY CHARACTERISTICS

MMZ0603S100C



MMZ0603S800C



MMZ0603S121C



MMZ0603S241C



MMZ0603S471C



MMZ0603S601C



MMZ0603S102H



MMZ0603Y750C



MMZ0603Y121C



MMZ0603Y241C



MMZ0603Y471C



MMZ0603Y601C



• All specifications are subject to change without notice.

TYPICAL ELECTRICAL CHARACTERISTICS

Z, X, R vs. FREQUENCY CHARACTERISTICS

MMZ0603D330C



MMZ0603D470C



MMZ0603D560C



MMZ0603D800C



MMZ0603D121C



MMZ0603F100C



MMZ0603F220C



MMZ0603F330C



PACKAGING STYLES

REEL DIMENSIONS



Dimensions in mm

TAPE DIMENSIONS



Dimensions in mm

• All specifications are subject to change without notice.

Chip Beads For Signal Line

Conformity to RoHS Directive

MMZ Series MMZ1005

FEATURES

- Size standardized for use by automatic assembly equipment. No preferred orientation.
- Electroplated terminal electrodes accommodate reflow soldering.
- High reliability due to an entirely monolithic structure.
- Closed magnetic circuit structure allows high-density installation while preventing crosstalk between circuits.
- Low DC resistance structure of electrode prevents wasteful electric power consumption.
- It is a product conforming to RoHS directive.

APPLICATIONS

Removal of signal line noises of cellular phones, PCs, note PCs, TVs, TV tuners, STBs, audio players, DVDs, DSCs, DVCs, game machines, digital photo frames, car navigation system, PNDs, etc.

PRODUCT IDENTIFICATION

| | | | | | | |
|-----|------|-----|-----|-----|-----|-----|
| MMZ | 1005 | S | 121 | C | T | □□□ |
| (1) | (2) | (3) | (4) | (5) | (6) | (7) |

- (1) Series name
- (2) Dimensions L×W
- (3) Type name
- (4) Impedance
121:120Ω at 100MHz
- (5) Characteristic type
- (6) Packaging style
T:Taping
- (7) TDK internal code

HANDLING AND PRECAUTIONS

- Before soldering, be sure to preheat components. The preheating temperature should be set so that the temperature difference between the solder temperature and product temperature does not exceed 150°C.
- After mounting components onto the printed circuit board, do not apply stress through board bending or mishandling.
- Do not expose the inductors to stray magnetic fields.
- Avoid static electricity discharge during handling.
- When hand soldering, apply the soldering iron to the printed circuit board only. Temperature of the iron tip should not exceed 350°C. Soldering time should not exceed 3 seconds.

MATERIAL CHARACTERISTICS

B material: This type is perfectly suited for fast digital signals. By equalizing R components and X components that beads possess at a frequency of 5MHz, it is able to suppress overshooting, undershooting and ringing of fast digital signals.

S material: Standard type that features impedance characteristics similar to those of a typical ferrite core. For signal line applications in which the blocking region is near 100MHz. Impedance values selected for effectiveness at 40 to 300MHz.

Y material: High frequency range type intended for the 100MHz region and above. For signal line applications in which the signal frequency is far from the cutoff frequency. Impedance values selected for effectiveness at 80 to 400MHz.

D material: For applications calling for low insertion loss at low frequencies and sharply increasing impedance at high frequencies. Designed for high impedance at high frequencies (300MHz to 1GHz) for signal line applications.

F material: This new product inherits the characteristic of our D-material, namely its sharp impedance rise time, and its impedance peak frequency has been shifted higher into range. The product offers excellent noise suppression from 600MHz to as high as in the GHz range.

TYPICAL MATERIAL CHARACTERISTICS



• Conformity to RoHS Directive: This means that, in conformity with EU Directive 2002/95/EC, lead, cadmium, mercury, hexavalent chromium, and specific bromine-based flame retardants, PBB and PBDE, have not been used, except for exempted applications.

• Please contact our Sales office when your application is considered the following:
The device's failure or malfunction may directly endanger human life (e.g. application for automobile/aircraft/medical/nuclear power devices, etc.)

• All specifications are subject to change without notice.

SHAPES AND DIMENSIONS/RECOMMENDED PC BOARD

PATTERN



SPECIFICATIONS

| | |
|-----------------------------|----------------------------|
| Operating temperature range | -55 to +125°C |
| Storage temperature range | -55 to +125°C(After mount) |

PACKAGING STYLE AND QUANTITIES

| | |
|-----------------|-------------------|
| Packaging style | Quantity |
| Taping | 10000 pieces/reel |

RECOMMENDED SOLDERING CONDITION

REFLOW SOLDERING



ELECTRICAL CHARACTERISTICS

| Part No. | Impedance (Ω)[100MHz]* | DC resistance (Ω)max. | Rated current (mA)max. |
|--------------|------------------------|-----------------------|------------------------|
| MMZ1005B800C | 80±25% | 0.19 | 450 |
| MMZ1005B121C | 120±25% | 0.25 | 400 |
| MMZ1005B601C | 600±25% | 0.85 | 200 |
| MMZ1005S800C | 80±25% | 0.12 | 500 |
| MMZ1005S121C | 120±25% | 0.22 | 500 |
| MMZ1005S241C | 240±25% | 0.28 | 400 |
| MMZ1005S601C | 600±25% | 0.52 | 300 |
| MMZ1005S102C | 1000±25% | 0.75 | 200 |
| MMZ1005Y400C | 40±25% | 0.10 | 550 |
| MMZ1005Y800C | 80±25% | 0.17 | 450 |
| MMZ1005Y121C | 120±25% | 0.18 | 400 |
| MMZ1005Y241C | 240±25% | 0.26 | 300 |
| MMZ1005Y301C | 300±25% | 0.38 | 250 |
| MMZ1005Y471C | 470±25% | 0.47 | 250 |
| MMZ1005Y601C | 600±25% | 0.54 | 250 |
| MMZ1005Y102C | 1000±25% | 0.70 | 200 |
| MMZ1005Y152C | 1500±25% | 1.00 | 100 |
| MMZ1005D100C | 10±5Ω | 0.10 | 500 |
| MMZ1005D220C | 22±25% | 0.17 | 400 |
| MMZ1005D330C | 33±25% | 0.24 | 400 |
| MMZ1005D680C | 68±25% | 0.38 | 400 |
| MMZ1005D121C | 120±25% | 0.60 | 350 |
| MMZ1005D241C | 240±25% | 0.90 | 200 |
| MMZ1005F330C | 33±25% | 0.50 | 200 |
| MMZ1005F470C | 47±25% | 0.60 | 100 |
| MMZ1005F560C | 56±25% | 0.70 | 100 |

* Test equipment: E4991A or equivalent
Test tool: 16192A or equivalent
Test temperature: 25±10°C

TYPICAL ELECTRICAL CHARACTERISTICS

Z FREQUENCY CHARACTERISTICS(DIFFERS ACCORDING TO SERIES)

MMZ1005B SERIES



MMZ1005S SERIES



MMZ1005Y SERIES



MMZ1005D SERIES



MMZ1005F SERIES



• All specifications are subject to change without notice.

TYPICAL ELECTRICAL CHARACTERISTICS

Z, X, R vs. FREQUENCY CHARACTERISTICS

MMZ1005B800C



MMZ1005B121C



MMZ1005B601C



MMZ1005S800C



MMZ1005S121C



MMZ1005S241C



MMZ1005S601C



MMZ1005S102C



MMZ1005Y400C



MMZ1005Y800C



MMZ1005Y121C



• All specifications are subject to change without notice.

TYPICAL ELECTRICAL CHARACTERISTICS

Z, X, R vs. FREQUENCY CHARACTERISTICS

MMZ1005Y241C



MMZ1005Y301C



MMZ1005Y471C



MMZ1005Y601C



MMZ1005Y102C



MMZ1005Y152C



MMZ1005D100C



MMZ1005D220C



MMZ1005D330C



MMZ1005D680C



MMZ1005D121C



MMZ1005D241C



• All specifications are subject to change without notice.

TYPICAL ELECTRICAL CHARACTERISTICS

Z, X, R vs. FREQUENCY CHARACTERISTICS

MMZ1005F330C

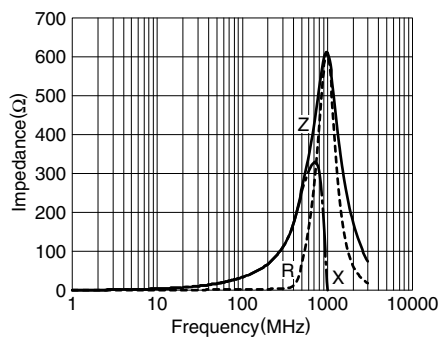

MMZ1005F470C

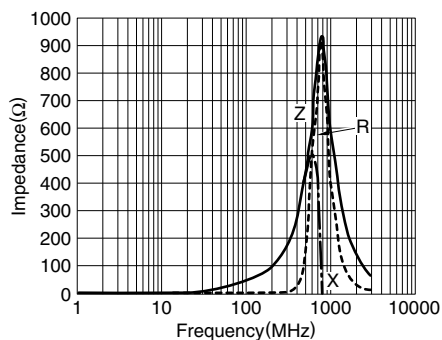

MMZ1005F560C

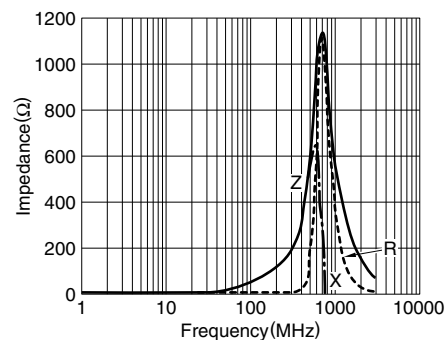

PACKAGING STYLES

REEL DIMENSIONS

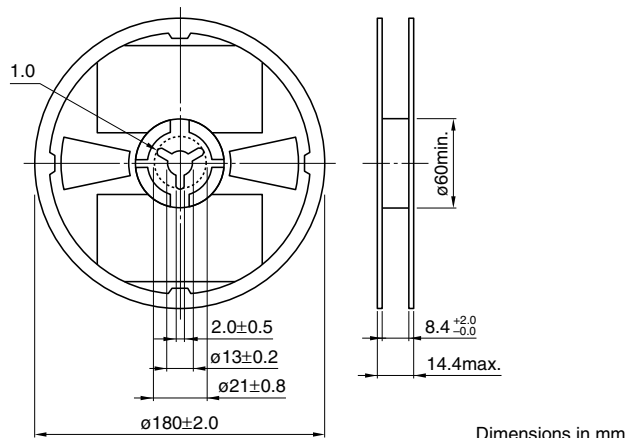

Dimensions in mm

TAPE DIMENSIONS

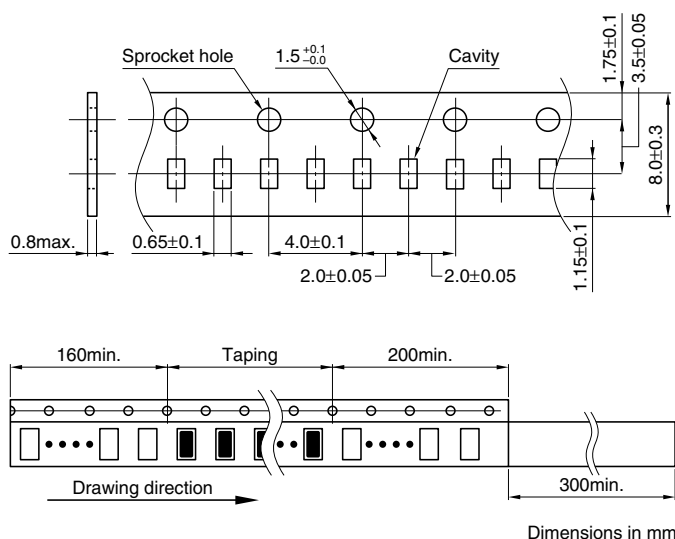

Dimensions in mm

• All specifications are subject to change without notice.

Chip Beads For Signal Line

Conformity to RoHS Directive

MMZ Series MMZ1608

FEATURES

- Chip bead(impeder), MMZ series offers 8 construction materials.
- Size standardized for use by automatic assembly equipment.
No preferred orientation.
- Either flow or reflow soldering methods can be used due to electroplating of the terminal electrodes.
- High reliability due to an entirely monolithic structure.
- Closed magnetic circuit structure allows high-density installation while preventing crosstalk between circuits.
- Low DC resistance structure of electrode prevents wasteful electric power consumption.
- The products contain no lead and also support lead-free soldering.
- It is a product conforming to RoHS directive.

APPLICATIONS

Removal of signal line noises of cellular phones, PCs, note PCs, TVs, TV tuners, STBs, audio players, DVDs, DSCs, DVCs, game machines, digital photo frames, car navigation system, PNDs, etc.

PRODUCT IDENTIFICATION

MMZ 1608 R 121 A T
 (1) (2) (3) (4) (5) (6) (7)

- (1) Series name
- (2) Dimensions L×W
- (3) Type name
- (4) Impedance
121:120Ω at 100MHz
- (5) Characteristic type
- (6) Packaging style
T:Taping
- (7) TDK internal code

HANDLING AND PRECAUTIONS

- Before soldering, be sure to preheat components. The preheating temperature should be set so that the temperature difference between the solder temperature and product temperature does not exceed 150°C.
- After mounting components onto the printed circuit board, do not apply stress through board bending or mishandling.
- Do not expose the inductors to stray magnetic fields.
- Avoid static electricity discharge during handling.
- When hand soldering, apply the soldering iron to the printed circuit board only. Temperature of the iron tip should not exceed 350°C. Soldering time should not exceed 3 seconds.

• Conformity to RoHS Directive: This means that, in conformity with EU Directive 2002/95/EC, lead, cadmium, mercury, hexavalent chromium, and specific bromine-based flame retardants, PBB and PBDE, have not been used, except for exempted applications.

• Please contact our Sales office when your application is considered the following:
The device's failure or malfunction may directly endanger human life (e.g. application for automobile/aircraft/medical/nuclear power devices, etc.)

• All specifications are subject to change without notice.

SHAPES AND DIMENSIONS/RECOMMENDED PC BOARD PATTERN



SPECIFICATIONS

| | |
|-----------------------------|----------------------------|
| Operating temperature range | -55 to +125°C |
| Storage temperature range | -55 to +125°C(After mount) |

PACKAGING STYLE AND QUANTITIES

| Packaging style | Quantity |
|-----------------|------------------|
| Taping | 4000 pieces/reel |

RECOMMENDED SOLDERING CONDITION REFLOW SOLDERING



MATERIAL CHARACTERISTICS

B material: This type is perfectly suited for fast digital signals.

By equalizing R components and X components that beads possess at a frequency of 5MHz, it is able to suppress overshooting, undershooting and ringing of fast digital signals.

R material: For wide frequency applications calling for broad impedance characteristics.

For digital signal line applications calling requiring good waveform integrity. Impedance values selected for effectiveness at 10 to 200MHz.

S material: Standard type that features impedance characteristics similar to those of a typical ferrite core.

For signal line applications in which the blocking region is near 100MHz. Impedance values selected for effectiveness at 40 to 300MHz.

Y material: High frequency range type intended for the 100MHz region and above.

For signal line applications in which the signal frequency is far from the cutoff frequency. Impedance values selected for effectiveness at 80 to 400MHz.

A material: This high-impedance product is based on the impedance frequency characteristics of our Y-material. The product offers excellent impedance characteristics, which is greater than 2500Ω, in the vicinity of 100MHz range (MMZ1608A252B).

Q material: For high-band applications designed for 100MHz and above. Impedance values selected for effectiveness at 100 to 800MHz.

D material: For applications calling for low insertion loss at low frequencies and sharply increasing impedance at high frequencies. Designed for high impedance at high frequencies (300MHz to 1GHz) for signal line applications.

F material: This new product inherits the characteristic of our D-material, namely its sharp impedance rise time, and its impedance peak frequency has been shifted higher into range.

The product offers excellent noise suppression from 600MHz to as high as in the GHz range.

TYPICAL MATERIAL CHARACTERISTICS



ELECTRICAL CHARACTERISTICS

| Part No. | Impedance (Ω) [100MHz]* | DC resistance (Ω)max. | Rated current (mA)max. | Product's thickness T(mm) |
|--------------|-------------------------|-----------------------|------------------------|---------------------------|
| MMZ1608B121C | 120±25% | 0.15 | 600 | 0.6 |
| MMZ1608B221C | 220±25% | 0.25 | 500 | 0.6 |
| MMZ1608B301C | 300±25% | 0.25 | 500 | 0.6 |
| MMZ1608B471C | 470±25% | 0.30 | 500 | 0.6 |
| MMZ1608B601C | 600±25% | 0.40 | 500 | 0.6 |
| MMZ1608B102C | 1000±25% | 0.60 | 300 | 0.8 |
| MMZ1608R150A | 15±25% | 0.05 | 1500 | 0.8 |
| MMZ1608R300A | 30±25% | 0.05 | 1500 | 0.8 |
| MMZ1608R600A | 60±25% | 0.10 | 800 | 0.8 |
| MMZ1608R121A | 120±25% | 0.18 | 500 | 0.8 |
| MMZ1608R301A | 300±25% | 0.25 | 500 | 0.8 |
| MMZ1608R471A | 470±25% | 0.30 | 500 | 0.8 |
| MMZ1608R601A | 600±25% | 0.40 | 500 | 0.8 |
| MMZ1608R102A | 1000±25% | 0.50 | 400 | 0.8 |
| MMZ1608S400A | 40±25% | 0.10 | 600 | 0.8 |
| MMZ1608S800A | 80±25% | 0.15 | 500 | 0.8 |
| MMZ1608S121A | 120±25% | 0.15 | 500 | 0.8 |
| MMZ1608S181A | 180±25% | 0.20 | 500 | 0.8 |
| MMZ1608S221A | 220±25% | 0.20 | 500 | 0.8 |
| MMZ1608S301A | 300±25% | 0.30 | 500 | 0.8 |
| MMZ1608S471A | 470±25% | 0.30 | 500 | 0.8 |
| MMZ1608S601A | 600±25% | 0.35 | 500 | 0.8 |
| MMZ1608S102A | 1000±25% | 0.50 | 400 | 0.8 |
| MMZ1608S202A | 2000±25% | 0.90 | 200 | 0.8 |
| MMZ1608Y150B | 15±25% | 0.05 | 1500 | 0.8 |
| MMZ1608Y300B | 30±25% | 0.05 | 1500 | 0.8 |
| MMZ1608Y600B | 60±25% | 0.15 | 500 | 0.8 |
| MMZ1608Y121B | 120±25% | 0.20 | 500 | 0.8 |
| MMZ1608Y221B | 220±25% | 0.30 | 500 | 0.8 |
| MMZ1608Y301B | 300±25% | 0.30 | 500 | 0.8 |
| MMZ1608Y471B | 470±25% | 0.35 | 500 | 0.8 |
| MMZ1608Y601B | 600±25% | 0.40 | 500 | 0.8 |
| MMZ1608Y751B | 750±25% | 0.45 | 500 | 0.8 |
| MMZ1608Y102B | 1000±25% | 0.50 | 400 | 0.8 |
| MMZ1608Y152B | 1500±25% | 0.60 | 300 | 0.8 |
| MMZ1608A182B | 1800±25% | 0.80 | 200 | 0.8 |
| MMZ1608A222B | 2200±25% | 0.80 | 200 | 0.8 |
| MMZ1608A252B | 2500±25% | 0.80 | 200 | 0.8 |
| MMZ1608Q121B | 120±25% | 0.30 | 500 | 0.8 |
| MMZ1608Q221B | 220±25% | 0.40 | 500 | 0.8 |
| MMZ1608Q331B | 330±25% | 0.50 | 400 | 0.8 |
| MMZ1608Q471B | 470±25% | 0.70 | 300 | 0.8 |
| MMZ1608Q601B | 600±25% | 0.80 | 200 | 0.8 |
| MMZ1608Q102B | 1000±25% | 1.00 | 200 | 0.8 |
| MMZ1608D050C | 5±2Ω | 0.05 | 700 | 0.8 |
| MMZ1608D100C | 10±5Ω | 0.10 | 500 | 0.6 |
| MMZ1608D220C | 22±25% | 0.20 | 500 | 0.6 |
| MMZ1608D500C | 50±25% | 0.25 | 500 | 0.6 |
| MMZ1608D800C | 80±25% | 0.30 | 500 | 0.6 |
| MMZ1608D800B | 80±25% | 0.30 | 500 | 0.8 |
| MMZ1608D121C | 120±25% | 0.30 | 400 | 0.6 |
| MMZ1608D121B | 120±25% | 0.30 | 400 | 0.8 |
| MMZ1608D241C | 240±25% | 0.60 | 300 | 0.8 |
| MMZ1608D301B | 300±25% | 0.70 | 300 | 0.8 |
| MMZ1608F030B | 3typ. | 0.05 | 700 | 0.8 |
| MMZ1608F470B | 47±25% | 0.40 | 500 | 0.8 |
| MMZ1608F750B | 75±25% | 0.55 | 300 | 0.8 |
| MMZ1608F121B | 120±25% | 0.75 | 200 | 0.8 |

* Test equipment: E4991A or equivalent

Test tool: 16192A or equivalent

Test temperature: 25±10°C

TYPICAL ELECTRICAL CHARACTERISTICS Z, X, R vs. FREQUENCY CHARACTERISTICS

MMZ1608B121C



MMZ1608B221C



MMZ1608B301C

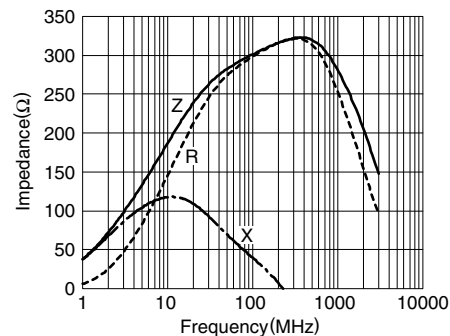

MMZ1608B471C



MMZ1608B601C



MMZ1608B102C

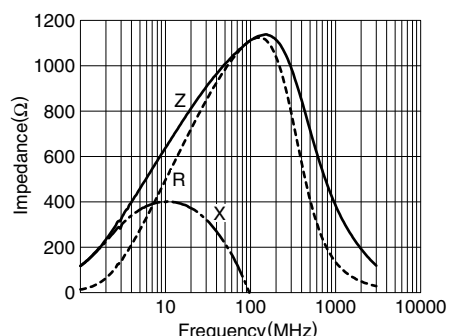

MMZ1608R150A



MMZ1608R300A



MMZ1608R600A



MMZ1608R121A



MMZ1608R301A



MMZ1608R471A



• All specifications are subject to change without notice.

TYPICAL ELECTRICAL CHARACTERISTICS

Z, X, R vs. FREQUENCY CHARACTERISTICS

MMZ1608R601A



MMZ1608R102A



MMZ1608S400A



MMZ1608S800A



MMZ1608S121A



MMZ1608S181A



MMZ1608S221A

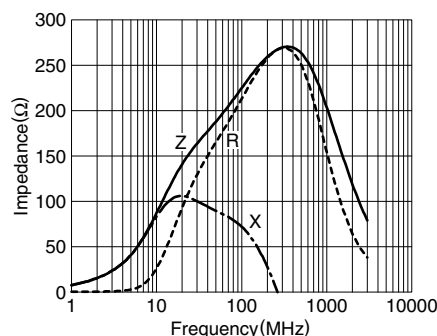

MMZ1608S301A



MMZ1608S471A



MMZ1608S601A

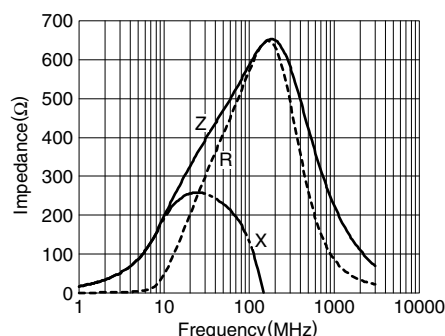

MMZ1608S102A

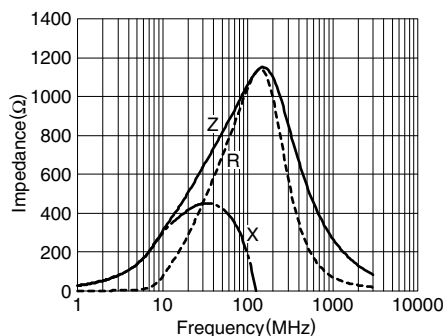

MMZ1608S202A



• All specifications are subject to change without notice.

TYPICAL ELECTRICAL CHARACTERISTICS Z, X, R vs. FREQUENCY CHARACTERISTICS

MMZ1608Y150B

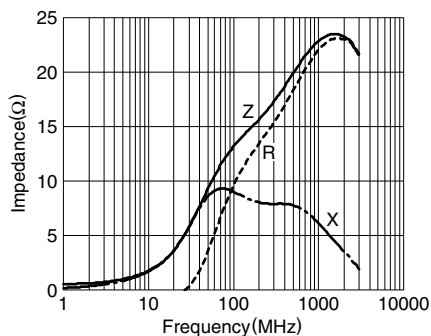

MMZ1608Y300B

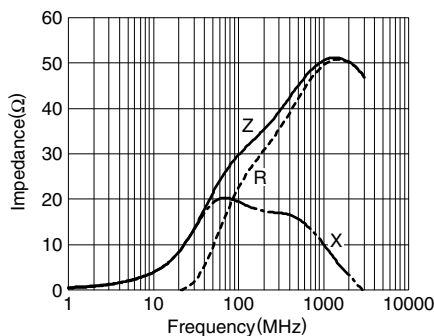

MMZ1608Y600B

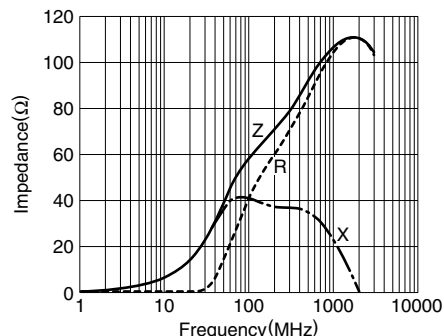

MMZ1608Y121B

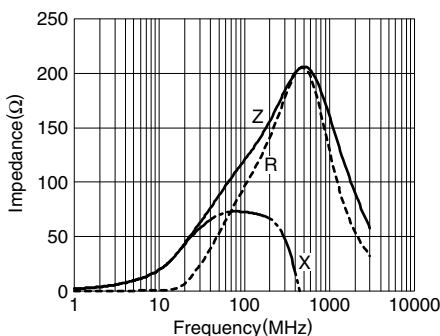

MMZ1608Y221B

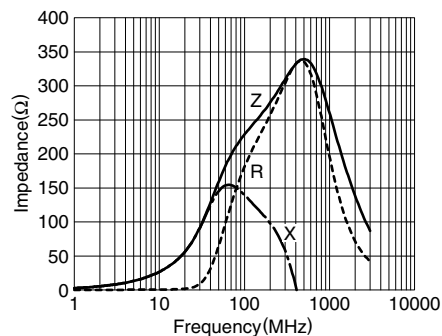

MMZ1608Y301B

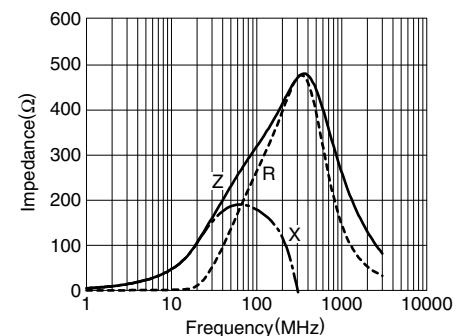

MMZ1608Y471B

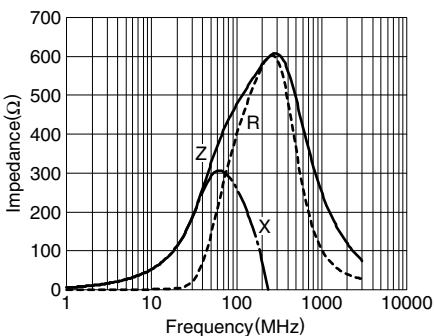

MMZ1608Y601B

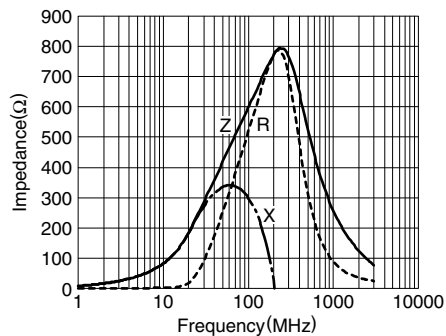

MMZ1608Y751B

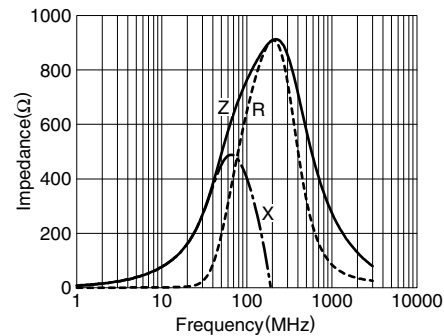

MMZ1608Y102B

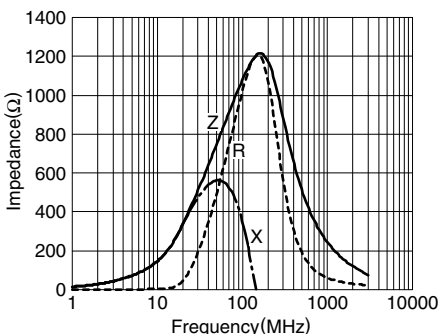

MMZ1608Y152B

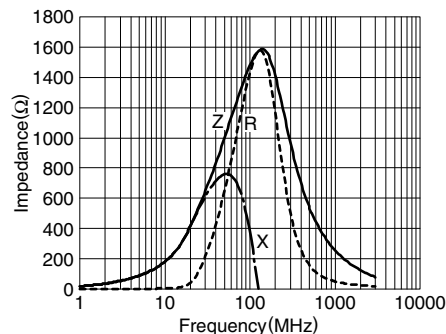

• All specifications are subject to change without notice.

TYPICAL ELECTRICAL CHARACTERISTICS

Z, X, R vs. FREQUENCY CHARACTERISTICS

MMZ1608A182B



MMZ1608A222B



MMZ1608A252B



MMZ1608Q121B



MMZ1608Q221B



MMZ1608Q331B



MMZ1608Q471B



MMZ1608Q601B



MMZ1608Q102B



MMZ1608D050C



MMZ1608D100C



MMZ1608D220C



• All specifications are subject to change without notice.

TYPICAL ELECTRICAL CHARACTERISTICS

Z, X, R vs. FREQUENCY CHARACTERISTICS

MMZ1608D500C



MMZ1608D800C



MMZ1608D800B



MMZ1608D121C



MMZ1608D121B



MMZ1608D241C



MMZ1608D301B



MMZ1608F030B



MMZ1608F470B



MMZ1608F750B



MMZ1608F121B



• All specifications are subject to change without notice.

PACKAGING STYLES
REEL DIMENSIONS



TAPE DIMENSIONS



• All specifications are subject to change without notice.

Chip Beads For Signal Line

Conformity to RoHS Directive

MMZ Series MMZ2012

FEATURES

- Chip bead(impeder), MMZ series offers 4 construction materials.
- Size standardized for use by automatic assembly equipment. No preferred orientation.
- Either flow or reflow soldering methods can be used due to electroplating of the terminal electrodes.
- High reliability due to an entirely monolithic structure.
- Closed magnetic circuit structure allows high-density installation while preventing crosstalk between circuits.
- Low DC resistance structure of electrode prevents wasteful electric power consumption.
- The products contain no lead and also support lead-free soldering.
- It is a product conforming to RoHS directive.

APPLICATIONS

Removal of signal line noises of cellular phones, PCs, note PCs, TVs, TV tuners, STBs, audio players, DVDs, DSCs, DVCs, game machines, digital photo frames, car navigation system, PNDs, etc.

PRODUCT IDENTIFICATION

| | | | | | | |
|-----|------|-----|-----|-----|-----|-----|
| MMZ | 2012 | R | 121 | A | T | □□□ |
| (1) | (2) | (3) | (4) | (5) | (6) | (7) |

- (1) Series name
- (2) Dimensions L×W
- (3) Type name
- (4) Impedance
121:120Ω at 100MHz
- (5) Characteristic type
- (6) Packaging style
T:Taping
- (7) TDK internal code

HANDLING AND PRECAUTIONS

- Before soldering, be sure to preheat components. The preheating temperature should be set so that the temperature difference between the solder temperature and product temperature does not exceed 150°C.
- After mounting components onto the printed circuit board, do not apply stress through board bending or mishandling.
- Do not expose the inductors to stray magnetic fields.
- Avoid static electricity discharge during handling.
- When hand soldering, apply the soldering iron to the printed circuit board only. Temperature of the iron tip should not exceed 350°C. Soldering time should not exceed 3 seconds.

• Conformity to RoHS Directive: This means that, in conformity with EU Directive 2002/95/EC, lead, cadmium, mercury, hexavalent chromium, and specific bromine-based flame retardants, PBB and PBDE, have not been used, except for exempted applications.

• Please contact our Sales office when your application is considered the following:
The device's failure or malfunction may directly endanger human life (e.g. application for automobile/aircraft/medical/nuclear power devices, etc.)

• All specifications are subject to change without notice.

MATERIAL CHARACTERISTICS

R material: For wide frequency applications calling for broad impedance characteristics.

For digital signal line applications calling requiring good waveform integrity. Impedance values selected for effectiveness at 10 to 200MHz.

S material: Standard type that features impedance characteristics similar to those of a typical ferrite core.

For signal line applications in which the blocking region is near 100MHz. Impedance values selected for effectiveness at 40 to 300MHz.

Y material: High frequency range type intended for the 100MHz region and above.

For signal line applications in which the signal frequency is far from the cutoff frequency. Impedance values selected for effectiveness at 80 to 400MHz.

D material: For applications calling for low insertion loss at low frequencies and sharply increasing impedance at high frequencies. Designed for high impedance at high frequencies (200 to 500MHz) for signal line applications.

TYPICAL MATERIAL CHARACTERISTICS



SHAPES AND DIMENSIONS/RECOMMENDED PC BOARD

PATTERN



SPECIFICATIONS

| | |
|-----------------------------|----------------------------|
| Operating temperature range | -55 to +125°C |
| Storage temperature range | -55 to +125°C(After mount) |

PACKAGING STYLE AND QUANTITIES

| | |
|-----------------|------------------|
| Packaging style | Quantity |
| Taping | 4000 pieces/reel |

RECOMMENDED SOLDERING CONDITION

REFLOW SOLDERING



ELECTRICAL CHARACTERISTICS

| Part No. | Impedance (Ω)[100MHz]* | DC resistance (Ω)max. | Rated current (mA)max. |
|--------------|------------------------|-----------------------|------------------------|
| MMZ2012R150A | 15±25% | 0.05 | 1500 |
| MMZ2012R300A | 30±25% | 0.05 | 1500 |
| MMZ2012R600A | 60±25% | 0.10 | 1000 |
| MMZ2012R121A | 120±25% | 0.12 | 800 |
| MMZ2012R301A | 300±25% | 0.15 | 600 |
| MMZ2012R601A | 600±25% | 0.20 | 500 |
| MMZ2012R102A | 1000±25% | 0.30 | 500 |
| MMZ2012S400A | 40±25% | 0.10 | 1000 |
| MMZ2012S800A | 80±25% | 0.10 | 800 |
| MMZ2012S121A | 120±25% | 0.15 | 800 |
| MMZ2012S181A | 180±25% | 0.15 | 600 |
| MMZ2012S301A | 300±25% | 0.20 | 600 |
| MMZ2012S601A | 600±25% | 0.30 | 500 |
| MMZ2012S102A | 1000±25% | 0.35 | 500 |
| MMZ2012Y150B | 15±25% | 0.05 | 1500 |
| MMZ2012Y300B | 30±25% | 0.05 | 1500 |
| MMZ2012Y600B | 60±25% | 0.10 | 1000 |
| MMZ2012Y121B | 120±25% | 0.12 | 800 |
| MMZ2012Y301B | 300±25% | 0.15 | 600 |
| MMZ2012Y601B | 600±25% | 0.20 | 500 |
| MMZ2012Y102B | 1000±25% | 0.30 | 500 |
| MMZ2012Y152B | 1500±25% | 0.40 | 500 |
| MMZ2012Y202B | 2000±25% | 0.50 | 400 |
| MMZ2012D800B | 80±25% | 0.30 | 500 |
| MMZ2012D121B | 120±25% | 0.30 | 500 |
| MMZ2012D301B | 300±25% | 0.50 | 400 |

* Test equipment: E4991A or equivalent
Test tool: 16192A or equivalent
Test temperature: 25±10°C

TYPICAL ELECTRICAL CHARACTERISTICS
Z, X, R vs. FREQUENCY CHARACTERISTICS

MMZ2012R150A

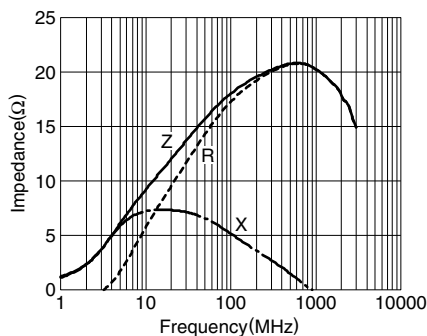

MMZ2012R300A

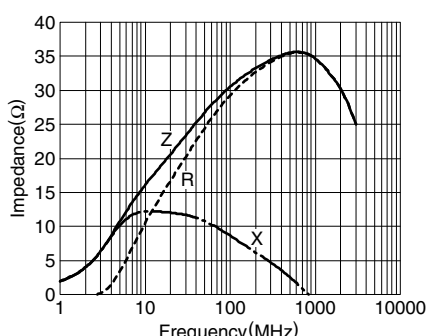

MMZ2012R600A



MMZ2012R121A

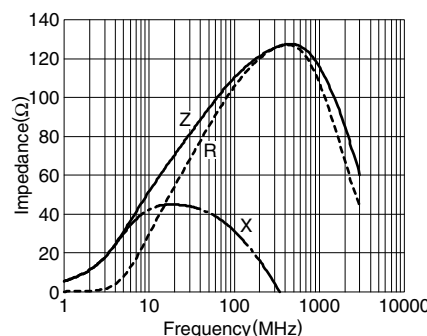

MMZ2012R301A

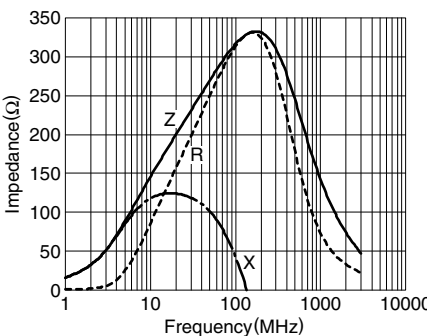

MMZ2012R601A

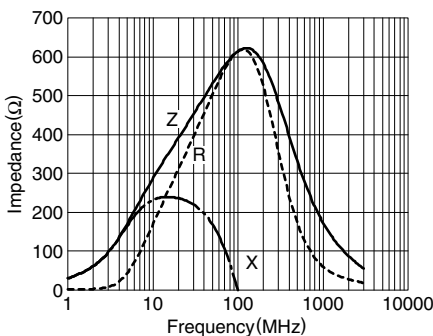

• All specifications are subject to change without notice.

TYPICAL ELECTRICAL CHARACTERISTICS

Z, X, R vs. FREQUENCY CHARACTERISTICS

MMZ2012R102A



MMZ2012S400A



MMZ2012S800A



MMZ2012S121A



MMZ2012S181A



MMZ2012S301A



MMZ2012S601A



MMZ2012S102A



MMZ2012Y150B



MMZ2012Y300B



MMZ2012Y600B



MMZ2012Y121B



• All specifications are subject to change without notice.

TYPICAL ELECTRICAL CHARACTERISTICS

Z, X, R vs. FREQUENCY CHARACTERISTICS

MMZ2012Y301B



MMZ2012Y601B



MMZ2012Y102B



MMZ2012Y152B



MMZ2012Y202B



MMZ2012D800B



MMZ2012D121B



MMZ2012D301B



PACKAGING STYLES
REEL DIMENSIONS

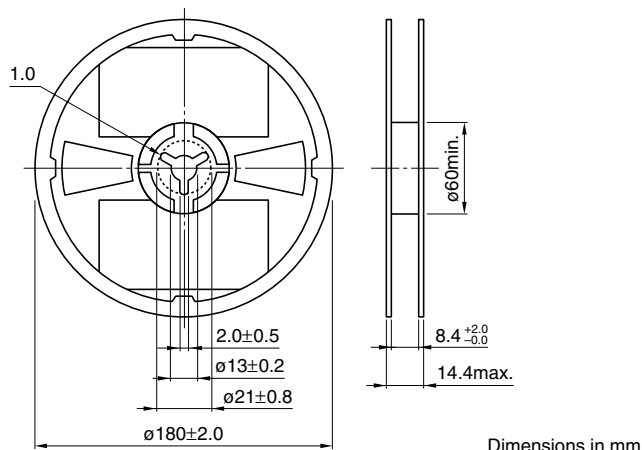

Dimensions in mm

TAPE DIMENSIONS

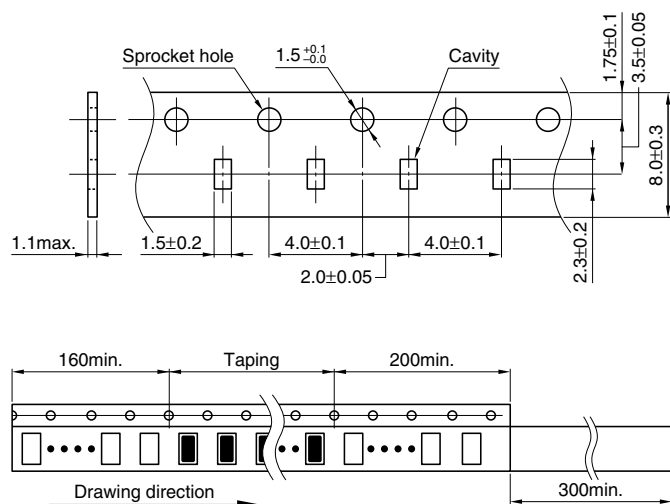

Dimensions in mm

• All specifications are subject to change without notice.

Chip Beads For Signal Line

Conformity to RoHS Directive

MMZ Series MMZ0603-E

FEATURES

- This is a multilayered chip bead product with dimensions of L0.6×W0.3×T0.3mm.
- Compared with the existing MMZ0603 type, this new product has broad-band impedance values for higher frequency ranges.
- The product is magnetically shielded, allowing high density mounting.
- We refined the rules for internal conductor design to reduce floating capacity between conductors, which in turn has contributed to a dramatic improvement in high frequency characteristics. We have also been able to expand and reinforce the EMI suppression in the GHz range.
- It is a product conforming to RoHS directive.

APPLICATIONS

Removal of signal line noises of cellular phones, portable audio players, various modules, DSCs, portable game machines, etc.

PRODUCT IDENTIFICATION

MMZ 0603 S 102 E T
 (1) (2) (3) (4) (5) (6) (7)

- (1) Series name
- (2) Dimensions L×W
- (3) Type name
- (4) Impedance
102:1000Ω at 100MHz
- (5) Characteristic type
- (6) Packaging style
T:Taping
- (7) TDK internal code

HANDLING AND PRECAUTIONS

- Before soldering, be sure to preheat components. The preheating temperature should be set so that the temperature difference between the solder temperature and product temperature does not exceed 150°C.
- After mounting components onto the printed circuit board, do not apply stress through board bending or mishandling.
- Do not expose the inductors to stray magnetic fields.
- Avoid static electricity discharge during handling.
- When hand soldering, apply the soldering iron to the printed circuit board only. Temperature of the iron tip should not exceed 350°C. Soldering time should not exceed 3 seconds.

SHAPES AND DIMENSIONS/RECOMMENDED PC BOARD PATTERN



SPECIFICATIONS

| | |
|-----------------------------|----------------------------|
| Operating temperature range | -55 to +125°C |
| Storage temperature range | -55 to +125°C(After mount) |

PACKAGING STYLE AND QUANTITIES

| | |
|-----------------|-------------------|
| Packaging style | Quantity |
| Taping | 15000 pieces/reel |

RECOMMENDED SOLDERING CONDITION

REFLOW SOLDERING



ELECTRICAL CHARACTERISTICS

| Part No. | Impedance(Ω)* | | DC resistance (Ω)max. | Rated current (mA)max. |
|--------------|---------------|----------|-----------------------|------------------------|
| | [100MHz] | [1GHz] | | |
| MMZ0603S601E | 600±25% | 1000±40% | 1.60 | 150 |
| MMZ0603S102E | 1000±25% | 1800±40% | 2.60 | 125 |

* Test equipment: E4991A or equivalent
 Test tool: 16197 or equivalent
 Test temperature: 25±10°C

• Conformity to RoHS Directive: This means that, in conformity with EU Directive 2002/95/EC, lead, cadmium, mercury, hexavalent chromium, and specific bromine-based flame retardants, PBB and PBDE, have not been used, except for exempted applications.

• Please contact our Sales office when your application is considered the following:
 The device's failure or malfunction may directly endanger human life (e.g. application for automobile/aircraft/medical/nuclear power devices, etc.)

• All specifications are subject to change without notice.

TYPICAL ELECTRICAL CHARACTERISTICS
Z FREQUENCY CHARACTERISTICS(DIFFERS ACCORDING TO SERIES)
MMZ0603S-E SERIES



TYPICAL ELECTRICAL CHARACTERISTICS
Z, X, R vs. FREQUENCY CHARACTERISTICS
MMZ0603S601E



MMZ0603S102E



PACKAGING STYLES
REEL DIMENSIONS



Dimensions in mm

TAPE DIMENSIONS

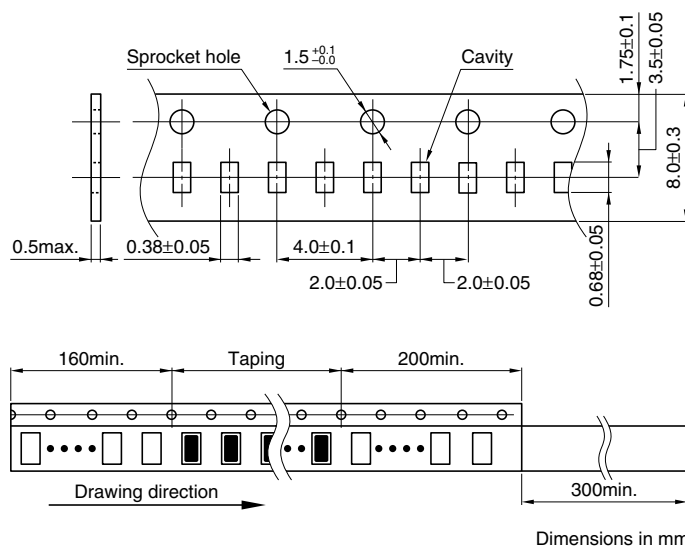

Dimensions in mm

• All specifications are subject to change without notice.

Chip Beads For Signal Line

Conformity to RoHS Directive

MMZ Series MMZ1005-E

FEATURES

- Compared with the existing MMZ1005 type, this new product has broad-band impedance values for higher frequency ranges.
- Size standardized for use by automatic assembly equipment. No preferred orientation.
- Electroplated terminal electrodes accommodate reflow soldering.
- High reliability due to an entirely monolithic structure.
- Closed magnetic circuit structure allows high-density installation while preventing crosstalk between circuits.
- Low DC resistance structure of electrode prevents wasteful electric power consumption.
- It is a product conforming to RoHS directive.

APPLICATIONS

Removal of signal line noises of cellular phones, PCs, note PCs, TVs, TV tuners, STBs, audio players, DVDs, DSCs, DVCs, game machines, digital photo frames, car navigation system, PNDs, etc.

SPECIFICATIONS

| | |
|-----------------------------|----------------------------|
| Operating temperature range | -55 to +125°C |
| Storage temperature range | -55 to +125°C(After mount) |

SHAPES AND DIMENSIONS/RECOMMENDED PC BOARD PATTERN



ELECTRICAL CHARACTERISTICS

| Part No. | Impedance(Ω)* | | DC resistance (Ω)max. | Rated current (mA)max. |
|--------------|---------------|----------|-----------------------|------------------------|
| | [100MHz] | [1GHz] | | |
| MMZ1005S601E | 600±25% | 1000±40% | 0.65 | 300 |
| MMZ1005S102E | 1000±25% | 1400±40% | 1.00 | 250 |
| MMZ1005S182E | 1800±25% | 1800±40% | 1.50 | 200 |
| MMZ1005A601E | 600±25% | 1400±40% | 0.80 | 300 |
| MMZ1005A102E | 1000±25% | 2000±40% | 1.20 | 250 |
| MMZ1005A152E | 1500±25% | 2300±40% | 1.60 | 230 |
| MMZ1005A182E | 1800±25% | 2700±40% | 2.10 | 200 |
| MMZ1005A222E | 2200±25% | 3000±40% | 2.20 | 150 |
| MMZ1005D121E | 120±25% | 1000±40% | 0.70 | 300 |
| MMZ1005D221E | 220±25% | 1700±40% | 1.00 | 250 |
| MMZ1005F470E | 47±25% | 800±40% | 0.70 | 300 |
| MMZ1005F750E | 75±25% | 1500±40% | 1.00 | 250 |
| MMZ1005F121E | 120±25% | 2300±40% | 1.50 | 200 |

* Test equipment: E4991A or equivalent
Test tool: 16192A or equivalent
Test temperature: 25±10°C

- Conformity to RoHS Directive: This means that, in conformity with EU Directive 2002/95/EC, lead, cadmium, mercury, hexavalent chromium, and specific bromine-based flame retardants, PBB and PBDE, have not been used, except for exempted applications.

- Please contact our Sales office when your application is considered the following:
The device's failure or malfunction may directly endanger human life (e.g. application for automobile/aircraft/medical/nuclear power devices, etc.)

- All specifications are subject to change without notice.

PRODUCT IDENTIFICATION

| | | | | | | |
|-----|------|-----|-----|-----|-----|-----|
| MMZ | 1005 | S | 601 | E | T | □□□ |
| (1) | (2) | (3) | (4) | (5) | (6) | (7) |

- (1) Series name
- (2) Dimensions L×W
- (3) Type name
- (4) Impedance
601:600Ω at 100MHz
- (5) Characteristic type
- (6) Packaging style
T:Taping
- (7) TDK internal code

PACKAGING STYLE AND QUANTITIES

| Packaging style | Quantity |
|-----------------|-------------------|
| Taping | 10000 pieces/reel |

HANDLING AND PRECAUTIONS

- Before soldering, be sure to preheat components. The preheating temperature should be set so that the temperature difference between the solder temperature and product temperature does not exceed 150°C.
- After mounting components onto the printed circuit board, do not apply stress through board bending or mishandling.
- Do not expose the inductors to stray magnetic fields.
- Avoid static electricity discharge during handling.
- When hand soldering, apply the soldering iron to the printed circuit board only. Temperature of the iron tip should not exceed 350°C. Soldering time should not exceed 3 seconds.

RECOMMENDED SOLDERING CONDITION REFLOW SOLDERING



TYPICAL ELECTRICAL CHARACTERISTICS

Z FREQUENCY CHARACTERISTICS(DIFFERS ACCORDING TO SERIES)

MMZ1005S-E SERIES



MMZ1005A-E SERIES



MMZ1005D-E SERIES



MMZ1005F-E SERIES



Z, X, R vs. FREQUENCY CHARACTERISTICS

MMZ1005S601E



MMZ1005S102E



MMZ1005S182E



MMZ1005A601E



MMZ1005A102E



MMZ1005A152E



• All specifications are subject to change without notice.

TYPICAL ELECTRICAL CHARACTERISTICS
Z, X, R vs. FREQUENCY CHARACTERISTICS

MMZ1005A182E



MMZ1005A222E



MMZ1005D121E



MMZ1005D221E



MMZ1005F470E



MMZ1005F750E



MMZ1005F121E



PACKAGING STYLES
REEL DIMENSIONS



Dimensions in mm

TAPE DIMENSIONS



Dimensions in mm

• All specifications are subject to change without notice.

Данный компонент на территории Российской Федерации

Вы можете приобрести в компании MosChip.

Для оперативного оформления запроса Вам необходимо перейти по данной ссылке:

<http://moschip.ru/get-element>

Вы можете разместить у нас заказ для любого Вашего проекта, будь то серийное производство или разработка единичного прибора.

В нашем ассортименте представлены ведущие мировые производители активных и пассивных электронных компонентов.

Нашей специализацией является поставка электронной компонентной базы двойного назначения, продукции таких производителей как XILINX, Intel (ex.ALTERA), Vicor, Microchip, Texas Instruments, Analog Devices, Mini-Circuits, Amphenol, Glenair.

Сотрудничество с глобальными дистрибьюторами электронных компонентов, предоставляет возможность заказывать и получать с международных складов практически любой перечень компонентов в оптимальные для Вас сроки.

На всех этапах разработки и производства наши партнеры могут получить квалифицированную поддержку опытных инженеров.

Система менеджмента качества компании отвечает требованиям в соответствии с ГОСТ Р ИСО 9001, ГОСТ РВ 0015-002 и ЭС РД 009

Офис по работе с юридическими лицами:

105318, г.Москва, ул.Щербаковская д.3, офис 1107, 1118, ДЦ «Щербаковский»

Телефон: +7 495 668-12-70 (многоканальный)

Факс: +7 495 668-12-70 (доб.304)

E-mail: info@moschip.ru

Skype отдела продаж:

moschip.ru

moschip.ru_4

moschip.ru_6

moschip.ru_9