

**STR. MALE MODULE 6 SOLDER TYPE INSERTS**  
**3 MM FOR PCB**

**R694.251.027**

Series : MCC2

6 Coax Position AB/1A,1B,1C

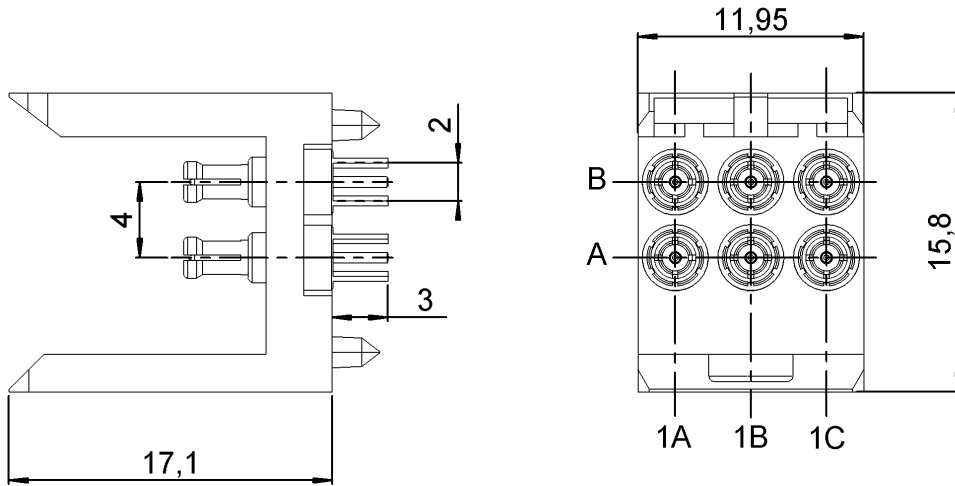

Connectors' packaging

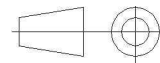
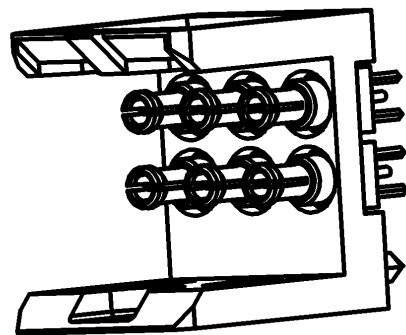
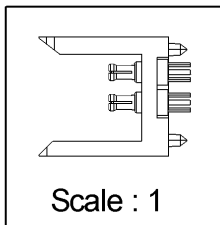
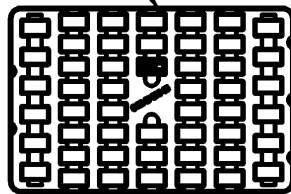

All dimensions are in mm.

COMPONENTS	MATERIALS	PLATING (µm)
BODY	BRONZE	NPGR
CENTER CONTACT	BRASS	NPGR
OUTER CONTACT	BRONZE	NPGR
INSULATOR	PTFE	
GASKET	-	
OTHERS PARTS	LIQUID CRISTAL POLYMER	
-	-	
-	-	

Issue : 0625 C

In the effort to improve our products, we reserve the right to make changes judged to be necessary.



**STR. MALE MODULE 6 SOLDER TYPE INSERTS**

**R694.251.027**

**3 MM FOR PCB**

Series : **MCC2**

**PACKAGING**

**SPECIFICATION**

Standard	Unit	Other
<b>50</b>	<b>'W' option</b>	<b>Contact us</b>

**ELECTRICAL CHARACTERISTICS**

**ENVIRONMENTAL**

Impedance	<b>50</b>	$\Omega$
Frequency	<b>0-6</b>	GHz
VSWR	<b>1.12 + 0,0000</b>	x F(GHz) Maxi
Insertion loss	<b>0.2</b>	$\sqrt{F}$ (GHz) dB Maxi
RF leakage	- (	- F(GHz)) dB Maxi
Voltage rating	<b>500</b>	Veff Maxi
Dielectric withstanding voltage	<b>750</b>	Veff mini
Insulation resistance	<b>5000</b>	M $\Omega$ mini

Operating temperature	<b>-25/+125</b>	$^{\circ}$ C
Hermetic seal	<b>NA</b>	Atm.cm3/s
Panel leakage	<b>NA</b>	

**OTHER CHARACTERISTICS**

Assembly instruction

Others :

VSWR=1.12 optimized between DC to 3GHz

**MECHANICAL CHARACTERISTICS**

Center contact retention		
Axial force – Mating end	<b>6</b>	N mini
Axial force – Opposite end	<b>6</b>	N mini
Torque	<b>NA</b>	N.cm mini
Recommended torque		
Mating	<b>NA</b>	N.cm
Panel nut	<b>NA</b>	N.cm
Mating life	<b>500</b>	Cycles mini
Weight	<b>98,2900</b>	g

Issue : 0625 C

In the effort to improve our products, we reserve the right to make changes judged to be necessary.



STR. MALE MODULE 6 SOLDER TYPE INSERTS

R694.251.027

3 MM FOR PCB

Series : MCC2

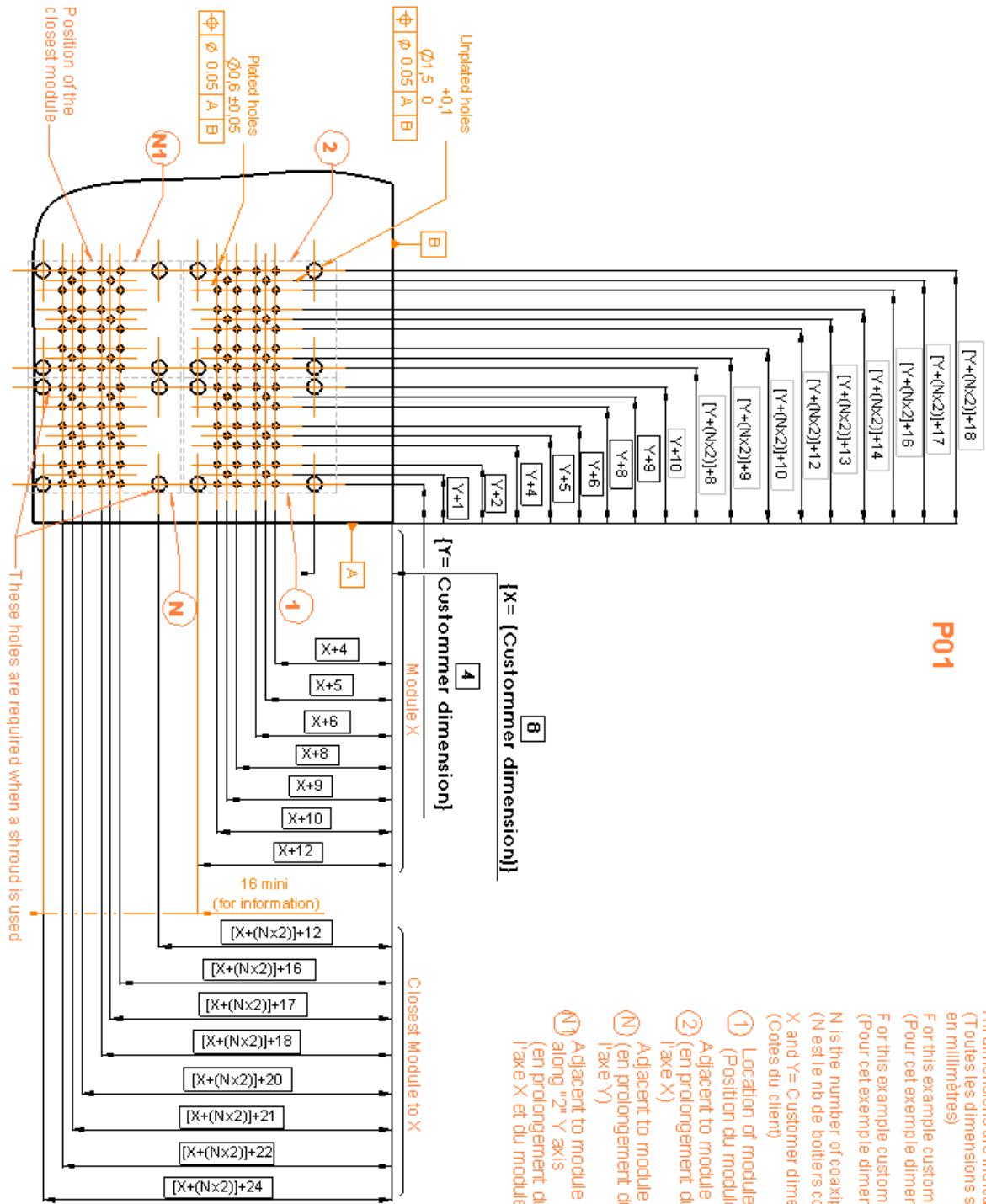

- All dimensions are indicated in millimetres (Toutes les dimensions sont indiquées en millimètres)
- F or this example customer dimension X=8mm (Pour cet exemple dimension du client X=8mm)
- F or this example customer dimension Y=4mm (Pour cet exemple dimension du client Y=4mm)
- N is the number of coaxialpack 2 (N est le nb de boîtiers coaxialpack 2)
- X and Y= Customer dimensions (Codes du client)
- ① Location of module "1"
  - ② Position of module "1" along X axis (en prolongement du module "1" selon l'axe X)
  - ③ Adjacent to module "1" along Y axis (en prolongement du module "1" selon l'axe Y)
  - ④ Adjacent to module "N" along X axis and along "2<sup>nd</sup>" Y axis (en prolongement du module "N" selon l'axe X et du module 2 selon l'axe Y)

Issue : 0625 C

In the effort to improve our products, we reserve the right to make changes judged to be necessary.



**STR. MALE MODULE 6 SOLDER TYPE INSERTS**

**R694.251.027**

**3 MM FOR PCB**

Series : MCC2

- Place the coax connector(s) on the PCB

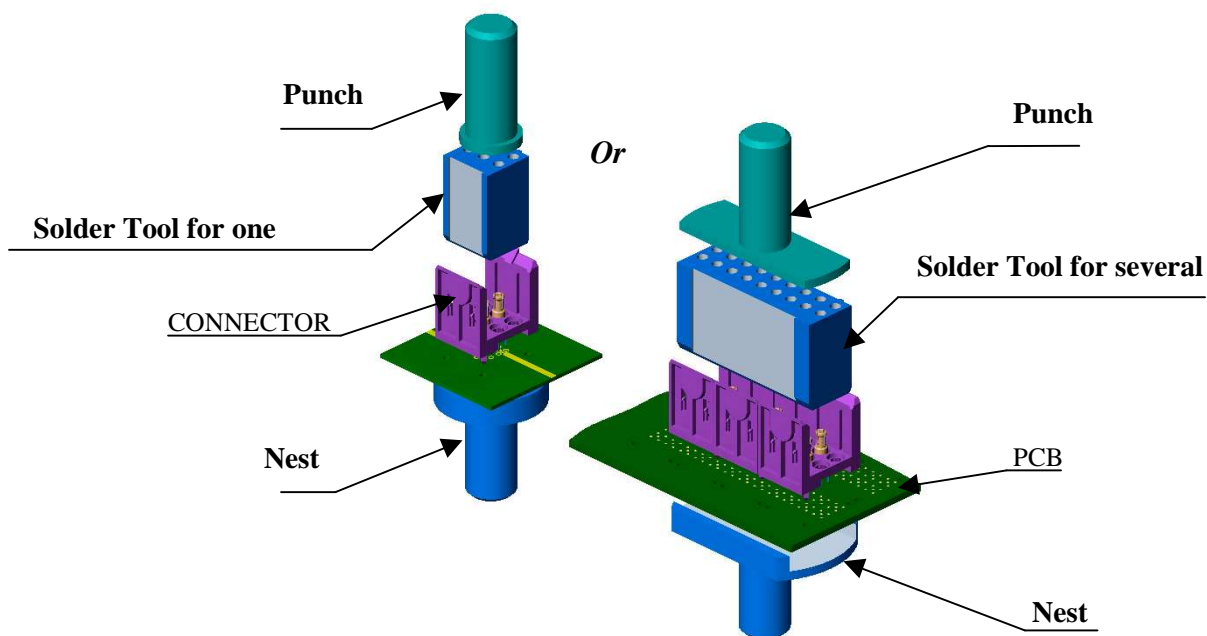

- Place correctly the PCB between the punch and the nest of the press.
- In case of multiple housing configuration , use a punch and a nest large enough to cover all the housings.
- Ensure solder legs are properly aligned with the holes before press-mounting.
- Press on the housing(s) with the punch until the complete insertion of the fixing stud into the PCB.

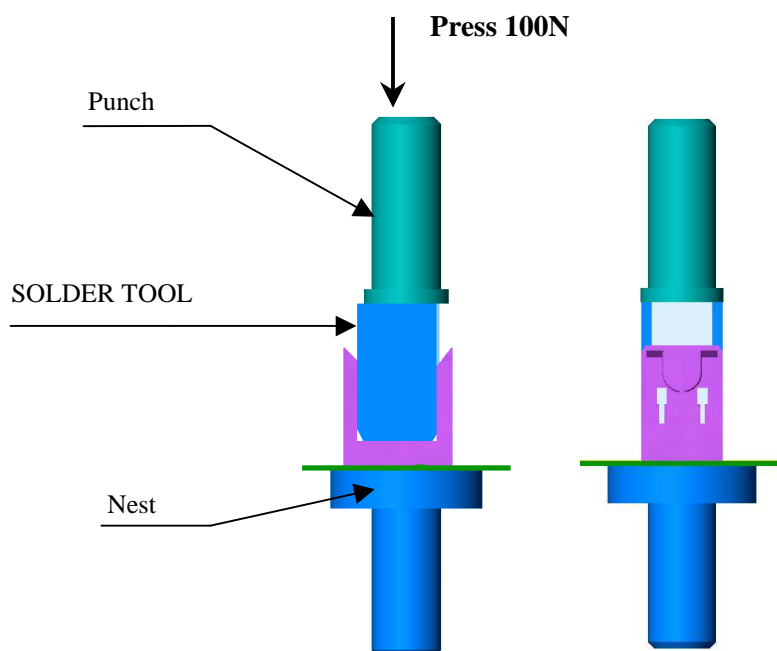

Issue : 0625 C

In the effort to improve our products, we reserve the right to make changes judged to be necessary.



**STR. MALE MODULE 6 SOLDER TYPE INSERTS****R694.251.027****3 MM FOR PCB**

Series : MCC2

- After the insertion of the connectors on the printed circuit , leave the solder tool inserted in position.
- Solder the legs on board

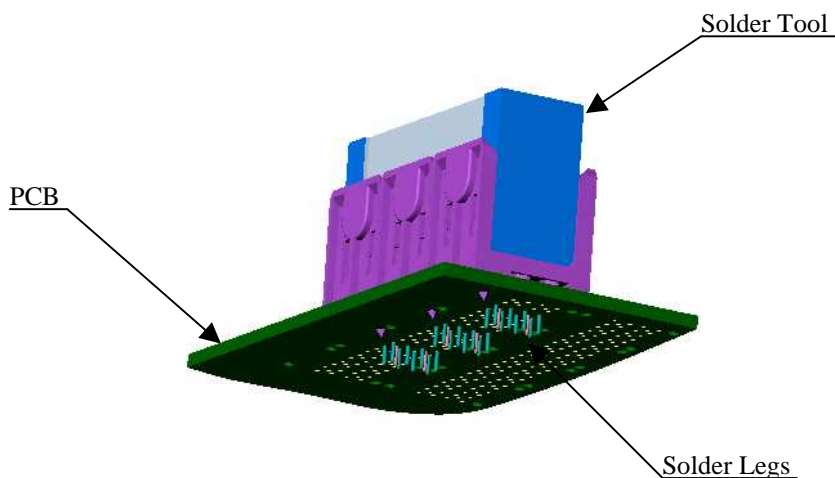

- After the solder legs have been soldered , using an appropriate soldering process , remove the solder tool.

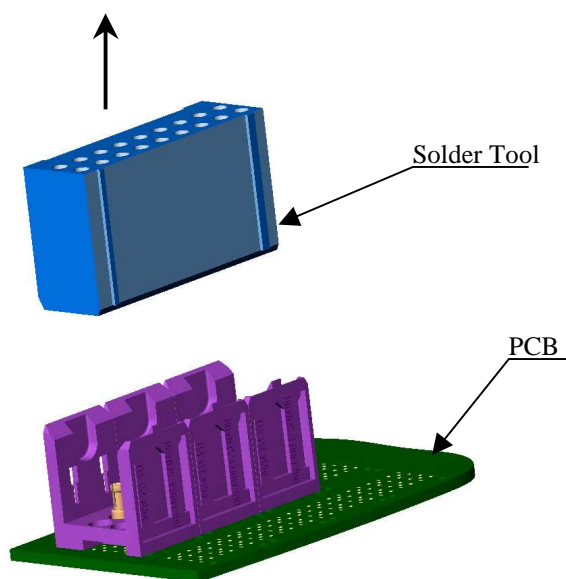

Radiall do not recommend to use more than 3 modules on the same motherboard and can't be held liable of any connection defect when more than 3 modules are implemented on the board.

Issue : 0625 C

In the effort to improve our products, we reserve the right to make changes judged to be necessary.



## Данный компонент на территории Российской Федерации

### Вы можете приобрести в компании MosChip.

Для оперативного оформления запроса Вам необходимо перейти по данной ссылке:

<http://moschip.ru/get-element>

Вы можете разместить у нас заказ для любого Вашего проекта, будь то серийное производство или разработка единичного прибора.

В нашем ассортименте представлены ведущие мировые производители активных и пассивных электронных компонентов.

Нашей специализацией является поставка электронной компонентной базы двойного назначения, продукции таких производителей как XILINX, Intel (ex.ALTERA), Vicor, Microchip, Texas Instruments, Analog Devices, Mini-Circuits, Amphenol, Glenair.

Сотрудничество с глобальными дистрибьюторами электронных компонентов, предоставляет возможность заказывать и получать с международных складов практически любой перечень компонентов в оптимальные для Вас сроки.

На всех этапах разработки и производства наши партнеры могут получить квалифицированную поддержку опытных инженеров.

Система менеджмента качества компании отвечает требованиям в соответствии с ГОСТ Р ИСО 9001, ГОСТ РВ 0015-002 и ЭС РД 009

### Офис по работе с юридическими лицами:

105318, г.Москва, ул.Щербаковская д.3, офис 1107, 1118, ДЦ «Щербаковский»

Телефон: +7 495 668-12-70 (многоканальный)

Факс: +7 495 668-12-70 (доб.304)

E-mail: [info@moschip.ru](mailto:info@moschip.ru)

Skype отдела продаж:

moschip.ru

moschip.ru\_4

moschip.ru\_6

moschip.ru\_9