

**SF2378E**

**925.2 MHz  
SAW Filter**

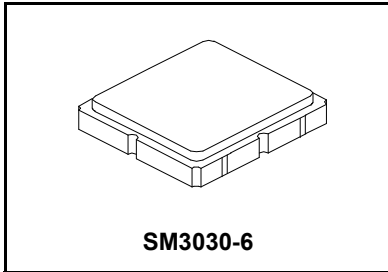

- **RF Filter for Mobile Communication Applications**
- **Low Insertion Loss**
- **3.0 x 3.0 x 1.3 mm Surface-Mount Case**

**Absolute Maximum Ratings**

Rating	Value	Units
Maximum Incident Power in Passband	+15	dBm
Maximum DC Voltage Between any 2 Terminals	3	VDC
Operating Temperature Range	-30 to +85	°C
Storage Temperature Range	-40 to +85	°C
Terminating Source Impedance (single) $Z_S$	50	$\Omega$
Terminating Load Impedance (single) $Z_L$	50	$\Omega$
Maximum Soldering Profile	260 °C for 10 s	

Characteristic	Sym	Notes	Min	Typ	Max	Units
Center Frequency	$f_C$			925.2		MHz
Minimum Insertion Loss, 922.3 - 928.1 MHz	IL			2.5	3.5	dB
Amplitude Ripple, 922.3 - 928.1 MHz				0.6	1.5	dB
VSWR						
Input (922.3 - 928.1 MHz)				1.4	2.0	
Output (922.3 - 928.1 MHz)				1.4	2.0	
Attenuation Referenced to 0 dB:						
10 to 815 MHz			42	45		dB
815 to 875 MHz			40	45		
875 to 905 MHz			35	40		
905 to 915 MHz			11	15		
945 to 950 MHz			35	40		
950 to 1150 MHz			50	55		
1150 to 1856 MHz			32	35		
1856 to 2500 MHz			32	35		

Case Style	SM3030-6 3 x 3 mm Nominal Footprint
Lid Symbolization (Y=year, WW=week, S=shift)	6F <u>Y</u> <u>W</u> <u>W</u> <u>S</u>

 **CAUTION: Electrostatic Sensitive Device. Observe precautions for handling.**

**NOTES:**

1. Unless noted otherwise, all specifications apply over the operating temperature range with filter soldered to the specified demonstration board with impedance matching to 50  $\Omega$  and measured with 50  $\Omega$  network analyzer.
2. Unless noted otherwise, all frequency specifications are referenced to the nominal center frequency,  $f_C$ .
3. Rejection is measured as attenuation below the minimum IL point in the passband. Rejection in final user application is dependent on PCB layout and external impedance matching design. See Application Note No. 42 for details.
4. "LRIP" or "L" after the part number indicates "low rate initial production" and "ENG" or "E" indicates "engineering prototypes."
5. The design, manufacturing process, and specifications of this filter are subject to change.
6. Either Port 1 or Port 2 may be used for either input or output in the design. However, impedances and impedance matching may vary between Port 1 and Port 2, so that the filter must always be installed in one direction per the circuit design.
7. US and international patents may apply.
8. Murata, stylized Murata logo, and Murata N.A., Inc. are registered trademarks of Murata Manufacturing Co., Ltd.
9. Electrostatic Sensitive Device. Observe precautions for handling.

## Electrical Connections

Connection	Terminals
Input	2
Output	5
Ground	All others

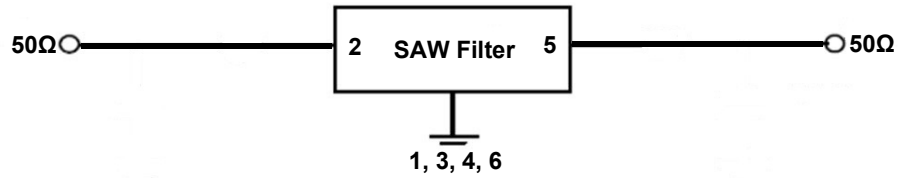

## Frequency Characteristics

### S21 Response: Span 200 MHz

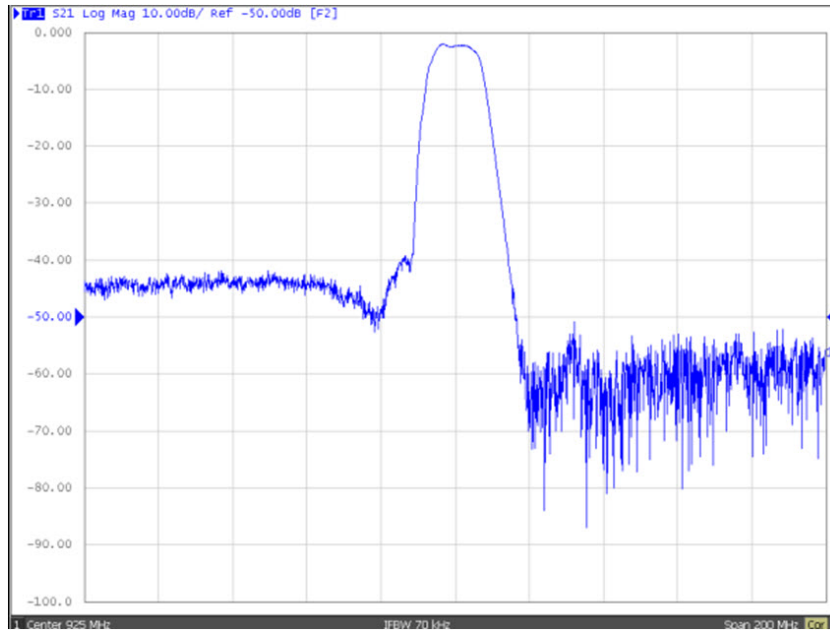

### S21 Response: Span 5 MHz

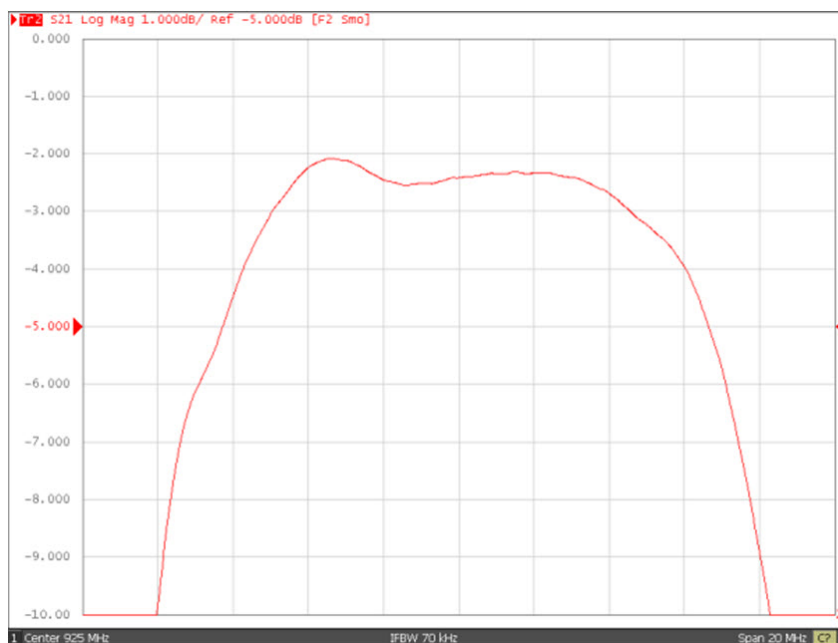

## S21 Response: Span 5 MHz

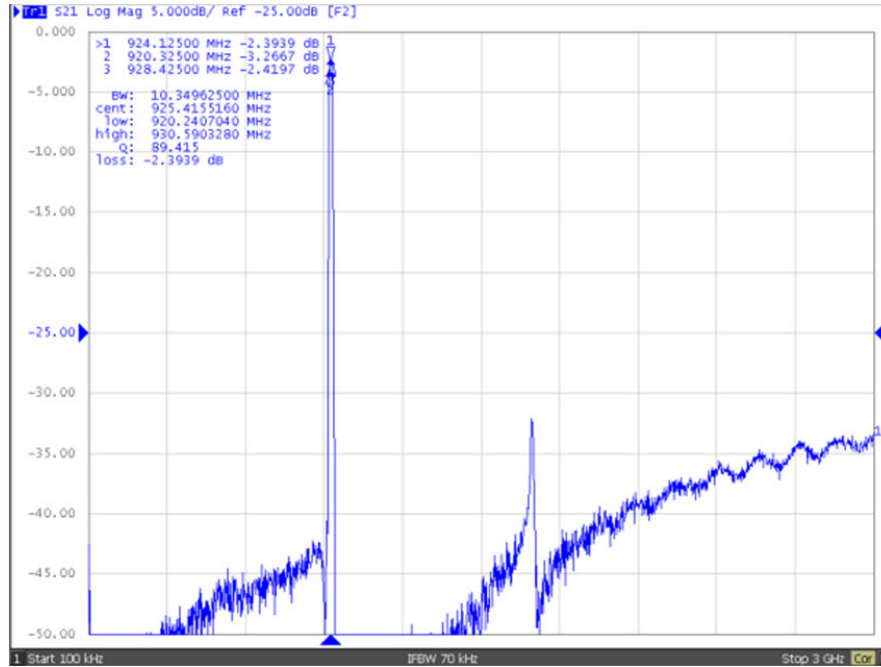

## S21 Response: Span 5 MHz

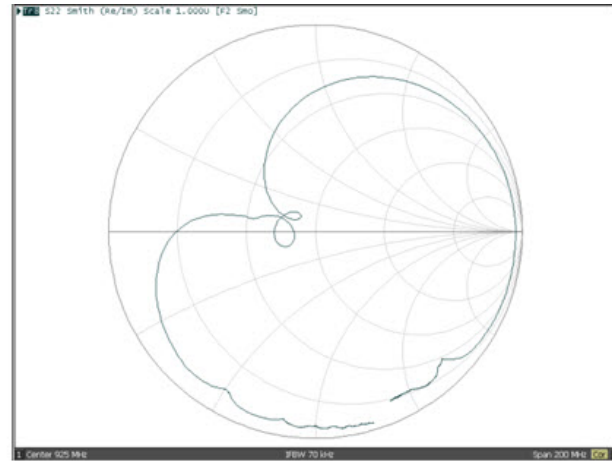
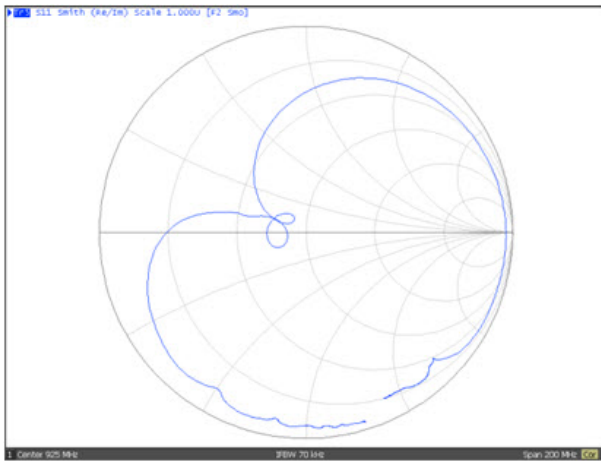

# SM3030-6 Case

## 6-Terminal Ceramic Surface-Mount Case 3.0 X 3.0 mm Nominal Footprint

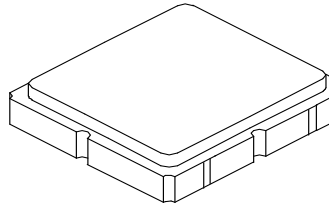

PCB Footprint, Top View

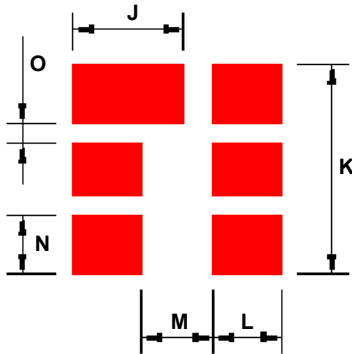

TOP VIEW

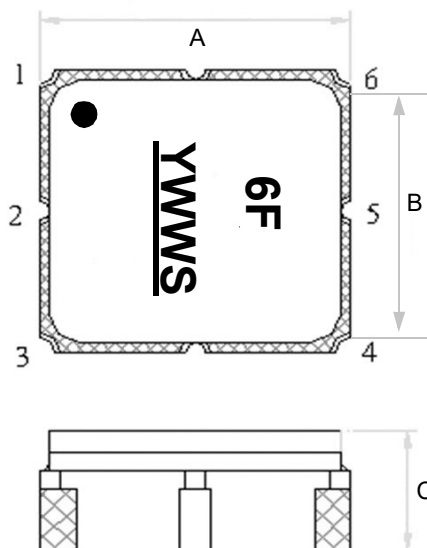

BOTTOM VIEW

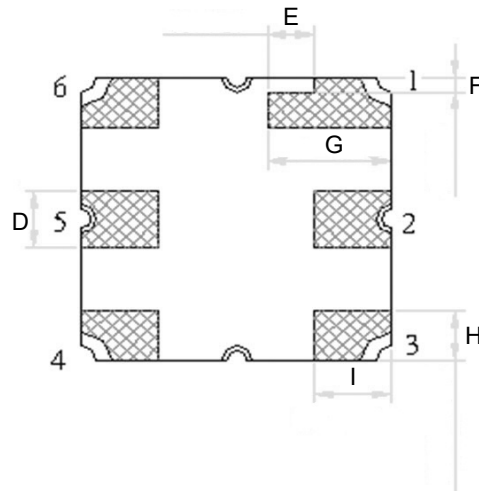

Case Dimensions

Dimension	mm			Inches		
	Min	Nom	Max	Min	Nom	Max
A	2.85	3.0	3.15-	0.151	0.118	0.124
B	2.85	3.0	3.15-	0.151	0.118	0.124
C	-	-	1.4	-	-	0.055
D	0.55	0.60	0.65	0.021	0.023	0.025
E	-	0.45	-	-	0.110	-
F	-	0.15	-	-	0.063	-
G	1.05	1.20	1.35	0.041	0.047	0.053
H	0.38	0.53	0.68	0.014	0.020	0.026
I	0.60	0.75	0.90	0.023	0.029	0.035
J	-	1.70	-	-	0.066	-
K	-	3.20	-	-	0.125	-
L	-	1.05	-	-	0.041	-
M	-	1.10	-	-	0.043	-
N	-	0.90	-	-	0.035	-
O	-	0.30	-	-	0.011	-

## Tape and Reel Specifications

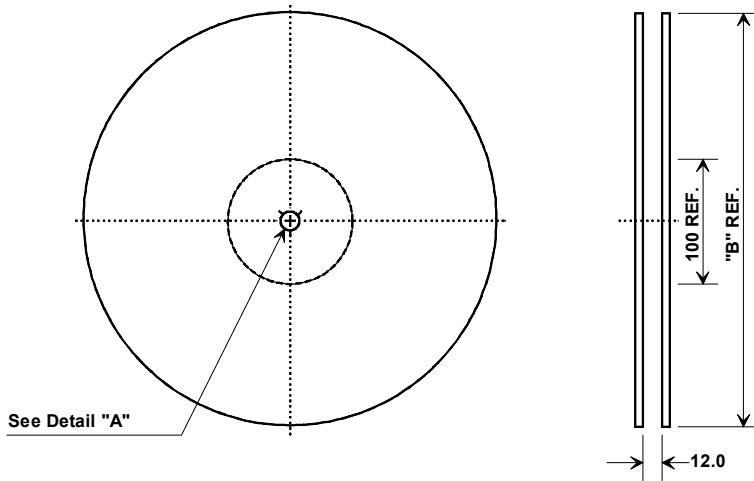

"B"		Quantity Per Reel
Inches	millimeters	
7	178	500
13	330	3000

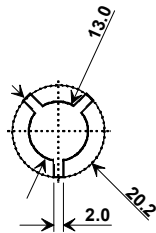

### COMPONENT ORIENTATION and DIMENSIONS

Carrier Tape Dimensions	
<b>Ao</b>	4.25 mm
<b>Bo</b>	4.25 mm
<b>Ko</b>	1.3 mm
<b>Pitch</b>	8.0 mm
<b>W</b>	12.0 mm

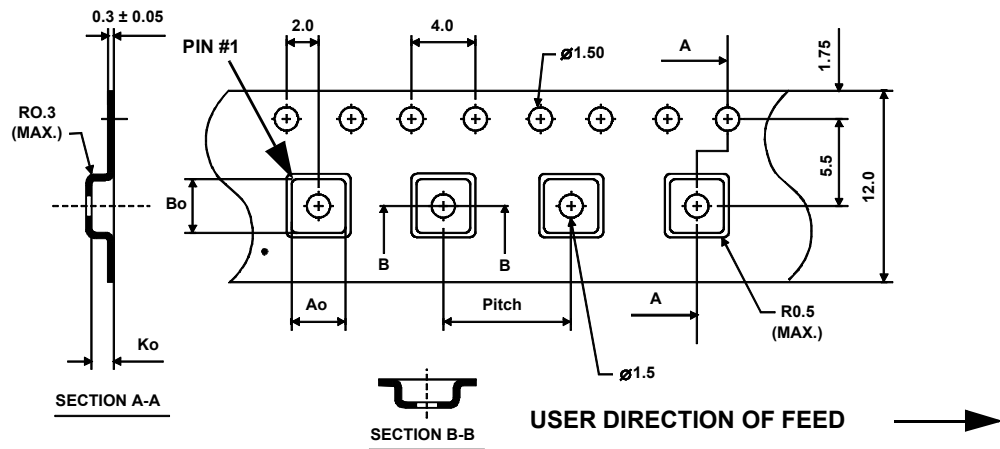

# Mouser Electronics

Authorized Distributor

Click to View Pricing, Inventory, Delivery & Lifecycle Information:

[Murata:](#)

[SF2378E](#)

## Данный компонент на территории Российской Федерации

### Вы можете приобрести в компании MosChip.

Для оперативного оформления запроса Вам необходимо перейти по данной ссылке:

<http://moschip.ru/get-element>

Вы можете разместить у нас заказ для любого Вашего проекта, будь то серийное производство или разработка единичного прибора.

В нашем ассортименте представлены ведущие мировые производители активных и пассивных электронных компонентов.

Нашей специализацией является поставка электронной компонентной базы двойного назначения, продукции таких производителей как XILINX, Intel (ex.ALTERA), Vicor, Microchip, Texas Instruments, Analog Devices, Mini-Circuits, Amphenol, Glenair.

Сотрудничество с глобальными дистрибьюторами электронных компонентов, предоставляет возможность заказывать и получать с международных складов практически любой перечень компонентов в оптимальные для Вас сроки.

На всех этапах разработки и производства наши партнеры могут получить квалифицированную поддержку опытных инженеров.

Система менеджмента качества компании отвечает требованиям в соответствии с ГОСТ Р ИСО 9001, ГОСТ РВ 0015-002 и ЭС РД 009

### Офис по работе с юридическими лицами:

105318, г.Москва, ул.Щербаковская д.3, офис 1107, 1118, ДЦ «Щербаковский»

Телефон: +7 495 668-12-70 (многоканальный)

Факс: +7 495 668-12-70 (доб.304)

E-mail: [info@moschip.ru](mailto:info@moschip.ru)

Skype отдела продаж:

moschip.ru

moschip.ru\_4

moschip.ru\_6

moschip.ru\_9