



Z8PE003

FEATURE-ENHANCED Z8PLUS 1K ROM ONE-TIME PROGRAMMABLE (OTP) MICROCONTROLLER

FEATURES

Part Number	ROM (kb)	RAM* (Bytes)	Speed (MHz)
Z8PE003	1	64	10

Note: *General-Purpose.

Microcontroller Core Features

- All Instructions Execute in one 1- μ s Instruction Cycle with a 10-MHz Crystal
- 1K x 8 On-Chip OTP EPROM Memory
- 64 x 8 General-Purpose Registers (SRAM)
- Six Vectored Interrupts with Fixed Priority
- Operating Speed: DC–10 MHz
- Six Addressing Modes: R, IR, X, D, RA, and IM

Peripheral Features

- 14 Total Input/Output Pins
- One 8-Bit I/O Port (Port A)
 - I/O Bit Programmable
 - Each Bit Programmable as Push-Pull or Open-Drain
- One 6-Bit I/O Port (Port B)
 - I/O Bit Programmable
 - Includes Special Functionality: Stop-Mode Recovery Input, Comparator Inputs, Selectable Edge Interrupts, and Timer Output
- One Analog Comparator

GENERAL DESCRIPTION

The Z8PE003 is the newest member of the Z8Plus Microprocessor (MPU) family. Similar to the Z8E000 and Z8E001, the Z8PE003 offers easy software development, debug, prototyping, and an attractive One-Time Programmable (OTP) solution.

- 16-Bit Programmable Watch-Dog Timer (WDT)
- Software Programmable Timers Configurable as:
 - Two 8-Bit Standard Timers and One 16-Bit Standard Timer
 - One 16-Bit Standard Timer and One 16-Bit Pulse Width Modulator (PWM) Timer

Additional Features

- On-Chip Oscillator that accepts External Crystal (XTAL), Ceramic Resonator, Inductor Capacitor (LC), or External Clocks
- External Resistor Capacitor (RC), an Oscillator Option
- Voltage Brown-Out/Power-On Reset (V_{BO}/POR)
- Programmable Options:
 - EPROM Protect
 - RC Oscillator
- Power Reduction Modes:
 - HALT Mode with Peripheral Units Active
 - STOP Mode for Minimum Power Dissipation

CMOS/Technology Features

- Low-Power Consumption
- 3.0V to 5.5V Operating Range @ 0°C to +70°C
- 4.5V to 5.5V Operating Range @ –40°C to +105°C
- 18-Pin DIP, SOIC, and 20-Pin SSOP Packages

For applications demanding powerful I/O capabilities, the Z8PE003's dedicated input and output lines are grouped into two ports, and are configurable under software control.

GENERAL DESCRIPTION (Continued)

Both the 8-bit and 16-bit on-chip timers, with several user-selectable modes, administer real-time tasks such as counting/timing and I/O data communications.

Note: All signals with an overline are active Low. For example, $\overline{B/W}$, in which WORD is active Low; and $\overline{B/W}$, in which BYTE is active Low.

Power connections follow conventional descriptions below:

Connection	Circuit	Device
Power	V _{CC}	V _{DD}
Ground	GND	V _{SS}



Figure 1. Functional Block Diagram



Figure 2. EPROM Programming Mode Block Diagram

PIN DESCRIPTION



Figure 3. 18-Pin DIP/SOIC Pin Identification

Table 1. Standard Programming Mode

Pin #	Symbol	Function	Direction
1–5	PB1–PB5	Port B, Pins 1,2,3,4,5	Input/Output
6–9	PA7–PA4	Port A, Pins 7,6,5,4	Input/Output
10–13	PA3–PA0	Port A, Pins 3,2,1,0	Input/Output
14	V _{CC}	Power Supply	
15	V _{SS}	Ground	
16	XTAL2	Crystal Oscillator Clock	Output
17	XTAL1	Crystal Oscillator Clock	Input
18	PB0	Port B, Pin 0	Input/Output



Figure 4. 18-Pin DIP/SOIC Pin Identification

Table 2. EPROM Programming Mode

Pin #	Symbol	Function	Direction
1	$\overline{\text{PGM}}$	Program Mode	Input
2–4	GND	Ground	
5	ADCLR/ V_{PP}	Clear Clock/Program Voltage	Input
6–9	D7–D4	Data 7,6,5,4	Input/Output
10–13	D3–D0	Data 3,2,1,0	Input/Output
14	V_{DD}	Power Supply	
15	GND	Ground	
16	NC	No Connection	
17	XTAL1	1-MHz Clock	Input
18	ADCLK	Address Clock	Input

PIN DESCRIPTION (Continued)



Figure 5. 20-Pin SSOP Pin Identification

Table 3. Standard Programming Mode

Pin #	Symbol	Function	Direction
1–5	PB1–PB5	Port B, Pins 1,2,3,4,5	Input/Output
6	NC	No Connection	
7–10	PA7–PA4	Port A, Pins 7,6,5,4	Input/Output
11–14	PA3–PA0	Port A, Pins 3,2,1,0	Input/Output
15	NC	No Connection	
16	V _{CC}	Power Supply	
17	V _{SS}	Ground	
18	XTAL2	Crystal Oscillator Clock	Output
19	XTAL1	Crystal Oscillator Clock	Input
20	PB0	Port B, Pin 0	Input/Output



Figure 6. 20-Pin SSOP Pin Identification/EPROM Programming Mode

Table 4. EPROM Programming Mode

Pin #	Symbol	Function	Direction
1	$\overline{\text{PGM}}$	Program Mode	Input
2–4	GND	Ground	
5	ADCLR/ V_{PP}	Clear Clock/Program Voltage	Input
6	NC	No Connection	
7–10	D7–D4	Data 7,6,5,4	Input/Output
11–14	D3–D0	Data 3,2,1,0	Input/Output
15	NC	No Connection	
16	V_{DD}	Power Supply	
17	GND	Ground	
18	NC	No Connection	
19	XTAL1	1-MHz Clock	Input
20	ADCLK	Address Clock	Input

ABSOLUTE MAXIMUM RATINGS

Parameter	Min	Max	Units	Note
Ambient Temperature under Bias	-40	+105	C	
Storage Temperature	-65	+150	C	
Voltage on any Pin with Respect to V_{SS}	-0.6	+7	V	1
Voltage on V_{DD} Pin with Respect to V_{SS}	-0.3	+7	V	
Voltage on PB5 Pin with Respect to V_{SS}	-0.6	$V_{DD}+1$	V	2
Total Power Dissipation		880	mW	
Maximum Allowable Current out of V_{SS}		40	mA	3
Maximum Allowable Current into V_{DD}		40	mA	3
Maximum Allowable Current into an Input Pin	-600	+600	μ A	4
Maximum Allowable Current into an Open-Drain Pin	-600	+600	μ A	5
Maximum Allowable Output Current Sunk by Any I/O Pin		25	mA	
Maximum Allowable Output Current Sourced by Any I/O Pin		25	mA	
Maximum Allowable Output Current Sunk by Port A		40	mA	3
Maximum Allowable Output Current Sourced by Port A		40	mA	3
Maximum Allowable Output Current Sunk by Port B		40	mA	3
Maximum Allowable Output Current Sourced by Port B		40	mA	3

Notes:

1. Applies to all pins except the PB5 pin and where otherwise noted.
2. There is no input protection diode from pin to V_{DD} .
3. Peak Current. Do not exceed 25mA average current in either direction.
4. Excludes XTAL pins.
5. Device pin is not at an output Low state.

Stresses greater than those listed under Absolute Maximum Ratings can cause permanent damage to the device. This rating is a stress rating only. Functional operation of the device at any condition above those indicated in the operational sections of these specifications is not implied. Exposure to absolute maximum rating conditions for an extended period

can affect device reliability. Total power dissipation should not exceed 880 mW for the package. Power dissipation is calculated as follows:

$$\begin{aligned} \text{Total Power Dissipation} &= V_{DD} \times [I_{DD} - (\text{sum of } I_{OH})] \\ &+ \text{sum of } [(V_{DD} - V_{OH}) \times I_{OH}] \\ &+ \text{sum of } (V_{OL} \times I_{OL}) \end{aligned}$$

STANDARD TEST CONDITIONS

The characteristics listed below apply for standard test conditions as noted. All voltages are referenced to Ground. Positive current flows into the referenced pin (Figure 7).



Figure 7. Test Load Diagram

CAPACITANCE

$T_A = 25^\circ\text{C}$, $V_{CC} = \text{GND} = 0\text{V}$, $f = 1.0\text{ MHz}$, unmeasured pins returned to GND.

Parameter	Min	Max
Input capacitance	0	12 pF
Output capacitance	0	12 pF
I/O capacitance	0	12 pF

DC ELECTRICAL CHARACTERISTICS

Table 5. DC Electrical Characteristics

T _A = 0°C to +70°C Standard Temperatures								
Sym	Parameter	V _{CC} ¹	Min	Max	Typical ² @ 25°C	Units	Conditions	Notes
V _{CH}	Clock Input High Voltage	3.0V	0.7V _{CC}	V _{CC} +0.3	1.3	V	Driven by External Clock Generator	
		5.5V	0.7V _{CC}	V _{CC} +0.3	2.5	V	Driven by External Clock Generator	
V _{CL}	Clock Input Low Voltage	3.0V	V _{SS} -0.3	0.2V _{CC}	0.7	V	Driven by External Clock Generator	
		5.5V	V _{SS} -0.3	0.2V _{CC}	1.5	V	Driven by External Clock Generator	
V _{IH}	Input High Voltage	3.0V	0.7V _{CC}	V _{CC} +0.3	1.3	V		
		5.5V	0.7V _{CC}	V _{CC} +0.3	2.5	V		
V _{IL}	Input Low Voltage	3.0V	V _{SS} -0.3	0.2V _{CC}	0.7	V		
		5.5V	V _{SS} -0.3	0.2V _{CC}	1.5	V		
V _{OH}	Output High Voltage	3.0V	V _{CC} -0.4		3.1	V	I _{OH} = -2.0 mA	
		5.5V	V _{CC} -0.4		4.8	V	I _{OH} = -2.0 mA	
V _{OL1}	Output Low Voltage	3.0V		0.6	0.2	V	I _{OL} = +4.0 mA	
		5.5V		0.4	0.1	V	I _{OL} = +4.0 mA	
V _{OL2}	Output Low Voltage	3.0V		1.2	0.5	V	I _{OL} = +6 mA	
		5.5V		1.2	0.5	V	I _{OL} = +12 mA	
V _{OFFSET}	Comparator Input Offset Voltage	3.0V		25.0	10.0	mV		
		5.5V		25.0	10.0	mV		
I _{IL}	Input Leakage	3.0V	-1.0	2.0	0.064	μA	V _{IN} = 0V, V _{CC}	
		5.5V	-1.0	2.0	0.064	μA	V _{IN} = 0V, V _{CC}	
I _{OL}	Output Leakage	3.0V	-1.0	2.0	0.114	μA	V _{IN} = 0V, V _{CC}	
		5.5V	-1.0	2.0	0.114	μA	V _{IN} = 0V, V _{CC}	
V _{ICR}	Comparator Input Common Mode Voltage Range	3.0V	V _{SS} -0.3	V _{CC} -1.0		V		3
		5.5V	V _{SS} -0.3	V _{CC} -1.0		V		3
R _{PB5}	PB5 Pull-up Resistor	3.0V	100		200	kOhm		4
		5.5V	100		200			
V _{LV}	V _{CC} Low-Voltage Protection		2.45	2.85	2.60	V		

Notes:

1. The V_{CC} voltage specification of 3.0V guarantees 3.0V; the V_{CC} voltage specification of 5.5V guarantees 5.0V ±0.5V.
2. Typical values are measured at V_{CC} = 3.3V and V_{CC} = 5.0V; V_{SS} = 0V = GND.
3. For the analog comparator input when the analog comparator is enabled.
4. No protection diode is provided from the pin to V_{CC}. External protection is recommended.
5. All outputs are unloaded and all inputs are at the V_{CC} or V_{SS} level.
6. CL1 = CL2 = 22 pF.
7. Same as note 5, except inputs are at V_{CC}.

Table 5. DC Electrical Characteristics (Continued)

T _A = 0°C to +70°C Standard Temperatures								
Sym	Parameter	V _{CC} ¹	Min	Max	Typical ² @ 25°C	Units	Conditions	Notes
I _{CC}	Supply Current	3.0V		2.5	2.0	mA	@ 10 MHz	5,6
		5.5V		6.0	3.5	mA	@ 10 MHz	5,6
I _{CC1}	Standby Current	3.0V		2.0	1.0	mA	HALT mode V _{IN} = 0V, V _{CC} @ 10 MHz	5,6
		5.5V		4.0	2.5	mA	HALT mode V _{IN} = 0V, V _{CC} @ 10 MHz	5,6
I _{CC2}	Standby Current			500	150	nA	STOP mode V _{IN} = 0V, V _{CC}	7

Notes:

1. The V_{CC} voltage specification of 3.0V guarantees 3.0V; the V_{CC} voltage specification of 5.5V guarantees 5.0V ±0.5V.
2. Typical values are measured at V_{CC} = 3.3V and V_{CC} = 5.0V; V_{SS} = 0V = GND.
3. For the analog comparator input when the analog comparator is enabled.
4. No protection diode is provided from the pin to V_{CC}. External protection is recommended.
5. All outputs are unloaded and all inputs are at the V_{CC} or V_{SS} level.
6. CL1 = CL2 = 22 pF.
7. Same as note 5, except inputs are at V_{CC}.

DC ELECTRICAL CHARACTERISTICS (Continued)

Table 6. DC Electrical Characteristics

$T_A = -40^{\circ}\text{C to } +105^{\circ}\text{C}$ Extended Temperatures								
Sym	Parameter	V_{CC}^1	Min	Max	Typical ² @ 25°C	Units	Conditions	Notes
V_{CH}	Clock Input High Voltage	4.5V	$0.7 V_{CC}$	$V_{CC}+0.3$	2.5	V	Driven by External Clock Generator	
		5.5V	$0.7 V_{CC}$	$V_{CC}+0.3$	2.5	V	Driven by External Clock Generator	
V_{CL}	Clock Input Low Voltage	4.5V	$V_{SS}-0.3$	$0.2 V_{CC}$	1.5	V	Driven by External Clock Generator	
		5.5V	$V_{SS}-0.3$	$0.2 V_{CC}$	1.5	V	Driven by External Clock Generator	
V_{IH}	Input High Voltage	4.5V	$0.7 V_{CC}$	$V_{CC}+0.3$	2.5	V		
		5.5V	$0.7 V_{CC}$	$V_{CC}+0.3$	2.5	V		
V_{IL}	Input Low Voltage	4.5V	$V_{SS}-0.3$	$0.2 V_{CC}$	1.5	V		
		5.5V	$V_{SS}-0.3$	$0.2 V_{CC}$	1.5	V		
V_{OH}	Output High Voltage	4.5V	$V_{CC}-0.4$		4.8	V	$I_{OH} = -2.0 \text{ mA}$	
		5.5V	$V_{CC}-0.4$		4.8	V	$I_{OH} = -2.0 \text{ mA}$	
V_{OL1}	Output Low Voltage	4.5V		0.4	0.1	V	$I_{OL} = +4.0 \text{ mA}$	
		5.5V		0.4	0.1	V	$I_{OL} = +4.0 \text{ mA}$	
V_{OL2}	Output Low Voltage	4.5V		1.2	0.5	V	$I_{OL} = +12 \text{ mA}$	
		5.5V		1.2	0.5	V	$I_{OL} = +12 \text{ mA}$	
V_{OFFSET}	Comparator Input Offset Voltage	4.5V		25.0	10.0	mV		
		5.5V		25.0	10.0	mV		
I_{IL}	Input Leakage	4.5V	-1.0	2.0	<1.0	μA	$V_{IN} = 0V, V_{CC}$	
		5.5V	-1.0	2.0	<1.0	μA	$V_{IN} = 0V, V_{CC}$	
I_{OL}	Output Leakage	4.5V	-1.0	2.0	<1.0	μA	$V_{IN} = 0V, V_{CC}$	
		5.5V	-1.0	2.0	<1.0	μA	$V_{IN} = 0V, V_{CC}$	
V_{ICR}	Comparator Input Common Mode Voltage Range	4.5V	0	$V_{CC}-1.5V$		V		3
		5.5V	0	$V_{CC}-1.5V$		V		3
R_{PB5}	PB5 Pull-up Resistor	4.5V	100		200	kOhm		4
		5.5V	100		200			
V_{LV}	V_{CC} Low-Voltage Protection		2.45	2.85	2.60	V		
I_{CC}	Supply Current	4.5V		7.0	4.0	mA	@ 10 MHz	5,6
		5.5V		7.0	4.0	mA	@ 10 MHz	5,6

Notes:

1. The V_{CC} voltage specification of 4.5V and 5.5V guarantees $5.0V \pm 0.5V$.
2. Typical values are measured at $V_{CC} = 5.0V$; $V_{SS} = 0V = \text{GND}$.
3. For analog comparator input when analog comparator is enabled.
4. No protection diode is provided from the pin to V_{CC} . External protection is recommended.
5. All outputs are unloaded and all inputs are at V_{CC} or V_{SS} level.
6. $CL1 = CL2 = 22 \text{ pF}$.
7. Same as note 5, except inputs are at V_{CC} .

Table 6. DC Electrical Characteristics (Continued)

T _A = -40°C to +105°C Extended Temperatures								
Sym	Parameter	V _{CC} ¹	Min	Max	Typical ² @ 25°C	Units	Conditions	Notes
I _{CC1}	Standby Current	4.5V		2.0	1.0	mA	HALT mode V _{IN} = 0V, V _{CC} @ 10 MHz	5,6
		5.5V		2.0	1.0	mA	HALT mode V _{IN} = 0V, V _{CC} @ 10 MHz	5,6
I _{CC2}	Standby Current	4.5V		700	250	nA	STOP mode V _{IN} = 0V, V _{CC}	7
		5.5V		700	250	nA	STOP mode V _{IN} = 0V, V _{CC}	7

Notes:

1. The V_{CC} voltage specification of 4.5V and 5.5V guarantees 5.0V ±0.5V.
2. Typical values are measured at V_{CC} = 5.0V; V_{SS} = 0V = GND.
3. For analog comparator input when analog comparator is enabled.
4. No protection diode is provided from the pin to V_{CC}. External protection is recommended.
5. All outputs are unloaded and all inputs are at V_{CC} or V_{SS} level.
6. CL1 = CL2 = 22 pF.
7. Same as note 5, except inputs are at V_{CC}.

AC ELECTRICAL CHARACTERISTICS



Figure 8. AC Electrical Timing Diagram

Table 7. Additional Timing

$T_A = 0^{\circ}\text{C to } +70^{\circ}\text{C}$ $T_A = -40^{\circ}\text{C to } +105^{\circ}\text{C}$ @ 10 MHz							
No	Symbol	Parameter	V_{CC}^1	Min	Max	Units	Notes
1	T_{pC}	Input Clock Period	3.0V	100	DC	ns	2
			5.5V	100	DC	ns	2
2	T_{RC}, T_{FC}	Clock Input Rise and Fall Times	3.0V		15	ns	2
			5.5V		15	ns	2
3	T_{WC}	Input Clock Width	3.0V	50		ns	2
			5.5V	50		ns	2
4	T_{WIL}	Int. Request Input Low Time	3.0V	70		ns	2
			5.5V	70		ns	2
5	T_{WHI}	Int. Request Input High Time	3.0V	5TpC			2
			5.5V	5TpC			2
6	T_{WSM}	STOP mode Recovery Width Spec.	3.0V	25		ns	
			5.5V	25		ns	
7	T_{OST}	Oscillator Start-Up Time	3.0V		5TpC		
			5.5V		5TpC		
8	T_{POR}	Power-On Reset Time	3.0V	128 T_{pC} + T_{OST}			
			5.5V				

Notes:

1. The V_{DD} voltage specification of 3.0V guarantees 3.0V. The V_{DD} voltage specification of 5.5V guarantees 5.0V \pm 0.5V.
2. Timing Reference uses 0.7 V_{CC} for a logical 1 and 0.2 V_{CC} for a logical 0.

Z8PLUS CORE

The device is based on the ZiLOG Z8Plus Core Architecture. This core is capable of addressing up to 64KB of program memory and 4 KB of RAM. Register RAM is accessed as either 8- or 16-bit registers using a combination of 4-, 8-, and 12-bit addressing modes. The architecture supports

up to 15 vectored interrupts from external and internal sources. The processor decodes 44 CISC instructions using 6 addressing modes. See the [Z8Plus User's Manual](#) for more information.

RESET

This section describes the Z8Plus reset conditions, reset timing, and register initialization procedures. Reset is generated by the Voltage Brown-Out/Power-On Reset (VBO/POR), Watch-Dog Timer (WDT), and Stop-Mode Recovery (SMR).

A system reset overrides all other operating conditions and puts the Z8Plus device into a known state. To initialize the chip's internal logic, the POR device counts 64 internal clock cycles after the oscillator stabilizes. The control registers and ports are not reset to their default conditions after wakeup from a STOP mode or WDT time-out.

During $\overline{\text{RESET}}$, the value of the program counter is 0020H. The I/O ports and control registers are configured to their

default reset state. Resetting the device does not affect the contents of the general-purpose registers.

The $\overline{\text{RESET}}$ circuit initializes the control and peripheral registers, as shown in Table 8. Specific reset values are indicated by a 1 or a 0, while bits whose states are unchanged or unknown from Power-Up are indicated by the letter U.

Program execution starts 10 External Crystal (XTAL) clock cycles after the POR delay. The initial instruction fetch is from location 0020H. Figure 9 indicates reset timing.

After a reset, the first routine executed must be one that initializes the TCTLHI control register to the required system configuration. This activity is followed by initialization of the remaining control registers.

Table 8. Control and Peripheral Registers*

Register (HEX)	Register Name	Bits								Comments
		7	6	5	4	3	2	1	0	
FF	Stack Pointer	0	0	U	U	U	U	U	U	Stack pointer is not affected by $\overline{\text{RESET}}$.
FE	Reserved									
FD	Register Pointer	U	U	U	U	0	0	0	0	Register pointer is not affected by $\overline{\text{RESET}}$.
FC	Flags	U	U	U	U	U	U	*	*	Only WDT & SMR flags are affected by $\overline{\text{RESET}}$.
FB	Interrupt Mask	0	0	0	0	0	0	0	0	All interrupts masked by $\overline{\text{RESET}}$.
FA	Interrupt Request	0	0	0	0	0	0	0	0	All interrupt requests cleared by $\overline{\text{RESET}}$.
F9-F0	Reserved									
EF-E0	Virtual Copy									Virtual copy of the current working register set.
DF-D8	Reserved									
D7	Port B Special Function	0	0	0	0	0	0	0	0	Deactivates all port special functions after $\overline{\text{RESET}}$.
D6	Port B Directional Control	0	0	0	0	0	0	0	0	Defines all bits as inputs in PortB after $\overline{\text{RESET}}$.
D5	Port B Output	U	U	U	U	U	U	U	U	Output register not affected by $\overline{\text{RESET}}$.

Note: *The SMR and WDT flags are set to indicate the source of the $\overline{\text{RESET}}$.

RESET (Continued)

Table 8. Control and Peripheral Registers* (Continued)

Register (HEX)	Register Name	Bits								Comments
		7	6	5	4	3	2	1	0	
D4	Port B Input	U	U	U	U	U	U	U	U	Current sample of the input pin following $\overline{\text{RESET}}$.
D3	Port A Special Function	0	0	0	0	0	0	0	0	Deactivates all port special functions after $\overline{\text{RESET}}$.
D2	Port A Directional Control	0	0	0	0	0	0	0	0	Defines all bits as inputs in PortA after $\overline{\text{RESET}}$.
D1	Port A Output	U	U	U	U	U	U	U	U	Output register not affected by $\overline{\text{RESET}}$
D0	Port A Input	U	U	U	U	U	U	U	U	Current sample of the input pin following $\overline{\text{RESET}}$.
CF	Reserved									
CE	Reserved									
CD	T1VAL	U	U	U	U	U	U	U	U	
CC	T0VAL	U	U	U	U	U	U	U	U	
CB	T3VAL	U	U	U	U	U	U	U	U	
CA	T2VAL	U	U	U	U	U	U	U	U	
C9	T3AR	U	U	U	U	U	U	U	U	
C8	T2AR	U	U	U	U	U	U	U	U	
C7	T1ARHI	U	U	U	U	U	U	U	U	
C6	T0ARHI	U	U	U	U	U	U	U	U	
C5	T1ARLO	U	U	U	U	U	U	U	U	
C4	T0ARLO	U	U	U	U	U	U	U	U	
C3	WDTHI	1	1	1	1	1	1	1	1	
C2	WDTLO	1	1	1	1	1	1	1	1	
C1	TCTLHI	1	1	1	1	1	0	0	0	WDT enabled in HALT mode, WDT time-out at maximum value, STOP mode disabled.
C0	TCTLLO	0	0	0	0	0	0	0	0	All standard timers are disabled.

Note: *The SMR and WDT flags are set to indicate the source of the $\overline{\text{RESET}}$.

Table 9. Flag Register Bit D1, D0

D1	D0	Reset Source
0	0	V _{BO} /POR
0	1	SMR Recovery
1	0	WDT Reset
1	1	Reserved



Figure 9. Reset Timing



Figure 10. Reset Circuitry with POR, WDT, V_{BO}, and SMR

INTERRUPT SOURCES

Table 10 presents the interrupt types, sources, and vectors available in the Z8Plus. Other processors from the Z8Plus family may define the interrupts differently.

Table 10. Interrupt Types, Sources, and Vectors

Name	Sources	Vector Location	Comments	Fixed Priority
IREQ ₀	Timer0 Time-out	2,3	Internal	1 (Highest)
IREQ ₁	PB4 High-to-Low Transition	4,5	External (PB4), Edge Triggered	2
IREQ ₂	Timer1 Time-out	6,7	Internal	3
IREQ ₃	PB2 High-to-Low Transition	8,9	External (PB2), Edge Triggered	4
IREQ ₄	PB4 Low-to-High Transition	A,B	External (PB4), Edge Triggered	5
IREQ ₅	Timer2 Time-out	C,D	Internal	6 (Lowest)
IREQ ₆ –IREQ ₁₅	Reserved		Reserved for future expansion	

External Interrupt Sources

External sources can be generated by a transition on the corresponding Port pin. The interrupt may detect a rising edge, a falling edge, or both.

Notes: The interrupt sources and trigger conditions are device dependent. See the device product specification to determine available sources (internal and external), triggering edge options, and exact programming details.

Although interrupts are edge triggered, minimum interrupt request Low and High times must be observed for proper operation. See the device product specification for exact timing requirements on external interrupt requests ($T_{W/L}$, $T_{W/H}$).

Internal Interrupt Sources

Internal interrupt sources and trigger conditions are device dependent. On-chip peripherals may set interrupt under various conditions. Some peripherals always set their corresponding IREQ bit while others must be specifically configured to do so.

See the device product specification to determine available sources, triggering edge options, and exact programming

details. For more details on the interrupt sources, refer to the chapters describing the timers, comparators, I/O ports, and other peripherals.

Interrupt Mask Register (IMASK) Initialization

The IMASK register individually or globally enables or disables the interrupts (Table 11). When bits 0 through 5 are set to 1, the corresponding interrupt requests are enabled. Bit 7 is the master enable bit and must be set before any of the individual interrupt requests can be recognized. Resetting bit 7 disables all the interrupt requests. Bit 7 is set and reset by the EI and DI instructions. It is automatically set to 0 during an interrupt service routine and set to 1 following the execution of an Interrupt Return (IRET) instruction. The IMASK registers are reset to 00h, disabling all interrupts.

Notes: It is not good programming practice to directly assign a value to the master enable bit. A value change should always be accomplished by issuing the EI and DI instructions.

Care should be taken not to set or clear IMASK bits while the master enable is set.

Table 11. Interrupt Mask Register—IMASK (FBh)

Bit	7	6	5	4	3	2	1	0
R/W	R/W	R/W	R/W	R/W	R/W	R/W	R/W	R/W
Reset	0	0	0	0	0	0	0	0
R = Read W = Write X = Indeterminate U = Undefined/ Undetermined								

Bit Position	R/W	Value	Description
7		0	Disables Interrupts
		1	Enables Interrupts
6		0	Reserved, must be 0
5		0	Disables IRQ5
		1	Enables IRQ5
4		0	Disables IRQ4
		1	Enables IRQ4
3		0	Disables IRQ3
		1	Enables IRQ3
2		0	Disables IRQ2
		1	Enables IRQ2
1		0	Disables IRQ1
		1	Enables IRQ1
0		0	Disables IRQ0
		1	Enables IRQ0

Interrupt Request (IREQ) Register Initialization

IREQ (Table 12) is a register that stores the interrupt requests for both vectored and polled interrupts. When an interrupt is issued, the corresponding bit position in the register is set to 1. Bits 0 to 5 are assigned to interrupt requests IREQ0 to IREQ5, respectively.

Whenever RESET is executed, the IREQ register is set to 00h.

Table 12. Interrupt Request Register—IREQ (FAh)

Bit	7	6	5	4	3	2	1	0
R/W	R/W	R/W	R/W	R/W	R/W	R/W	R/W	R/W
Reset	0	0	0	0	0	0	0	0
R = Read W = Write X = Indeterminate U = Undefined/ Undetermined								

Bit Position	R/W	Value	Description
7	R/W	0	Reserved, must be 0
6	R/W	0	Reserved, must be 0
5	R/W	0	IRQ5 reset
		1	IRQ5 set
4	R/W	0	IRQ4 reset
		1	IRQ4 set
3	R/W	0	IRQ3 reset
		1	IRQ3 set
2	R/W	0	IRQ2 reset
		1	IRQ2 set
1	R/W	0	IRQ1 reset
		1	IRQ1 set
0	R/W	0	IRQ0 reset
		1	IRQ0 set

IREQ SOFTWARE INTERRUPT GENERATION

IREQ can be used to generate software interrupts by specifying IREQ as the destination of any instruction referencing the Z8Plus Standard Register File. These software interrupts (SWI) are controlled in the same manner as hardware generated requests. In other words, the IMASK controls the enabling of each SWI.

To generate a SWI, the request bit in IREQ is set by the following statement:

```
OR IREQ, #NUMBER
```

The immediate data variable, NUMBER, has a 1 in the bit position corresponding to the required level of SWI. For example, an SWI must be issued when an IREQ5 occurs. Bit 5 of NUMBER must have a value of 1.

```
OR IREQ, #00100000B
```

If the interrupt system is globally enabled, IREQ5 is enabled, and there are no higher priority requests pending, control is transferred to the service routine pointed to by the IREQ5 vector.

Note: Software may modify the IREQ register at any time. Care should be taken when using any instruction that modifies the IREQ register while interrupt sources are active. The software writeback always takes precedence over the hardware. If a software writeback takes place on the same cycle as an interrupt source tries to set an IREQ bit, the new interrupt is lost.

PROGRAMMABLE OPTIONS

EPROM Protect. When selecting the DISABLE EPROM PROTECT/ENABLE TESTMODE option, the user can read the software code in the program memory. ZiLOG's internal factory test mode, or any of the standard test mode methods, are useful for reading or verifying the code in the microcontroller when using an EPROM programmer. If the user should select the ENABLE EPROM PROTECT/DISABLE TESTMODE option, it is not possible to read the code using a tester, programmer, or any other standard method. As a result, ZiLOG is unable to test the EPROM memory at any time after customer delivery.

Nesting of Vectored Interrupts

Nesting vectored interrupts allows higher priority requests to interrupt a lower priority request. To initiate vectored interrupt nesting, perform the following steps during the interrupt service routine:

- PUSH the old IMASK on the stack
- Load IMASK with a new mask to disable lower priority interrupts
- Execute an EI instruction
- Proceed with interrupt processing
- Execute a DI instruction after processing is complete
- Restore the IMASK to its original value by POPing the previous mask from the stack
- Execute IRET

Depending on the application, some simplification of the above procedure may be possible.

RESET Conditions

The IMASK and IREQ registers initialize to 00h on RESET.

This option bit only affects the user's ability to read the code and has no effect on the operation of the part in an application. ZiLOG tests the EPROM memory before customer delivery whether or not the ENABLE EPROM PROTECT/DISABLE TESTMODE option is selected; ZiLOG provides a standard warranty for the part.

System Clock Source. When selecting the RC OSCILLATOR ENABLE option, the oscillator circuit on the microcontroller is configured to work with an external RC circuit. When selecting the Crystal/Other Clock Source option, the oscillator circuit is configured to work with an external crystal, ceramic resonator, or LC oscillator.

WATCH-DOG TIMER

The Watch-Dog Timer (WDT) is a retriggerable one-shot 16-bit timer that resets the device if it reaches its terminal count. The WDT is driven by the XTAL2 clock pin. To provide the longer time-out periods required in applications, the watch-dog timer is only updated every 64th clock cycle. When operating in the RUN or HALT modes, a WDT time-out reset is functionally equivalent to an interrupt vectoring the PC to 0020H, and setting the WDT flag to 1. Coming out of RESET, the WDT is fully enabled with its time-out value set at minimum, unless otherwise programmed during the first instruction. Subsequent executions of the WDT instruction reinitialize the watch-dog timer registers (C2h and C3h) to their initial values as defined by bits D6, D5, and D4 of the TCTLHI register. The WDT cannot be disabled except on the first cycle after RESET and when the device enters STOP mode.

The WDT instruction should be executed often enough to provide some margin of time to allow the WDT registers to approach 0. Because the WDT time-out periods are relatively long, a WDT RESET occurs in the unlikely event that the WDT times out on exactly the same cycle that the WDT instruction is executed.

RESET clears both the WDT and SMR flags. A WDT time-out sets the WDT flag, and the STOP instruction sets the SMR flag. This function enables software to determine whether a WDT time-out or a return from STOP mode occurred. Reading the WDT and SMR flags does not reset the flag to 0; therefore, the user must clear the flag via software.

Note: Failure to clear the SMR flag can result in unexpected behavior.



Figure 11. TCTLHI Register for Control of WDT

Note: The WDT can only be disabled via software if the first instruction out of the $\overline{\text{RESET}}$ performs this function. Logic within the device detects that it is in the process of executing the first instruction after the processor leaves $\overline{\text{RESET}}$. During the execution of this instruction, the upper five bits of the TCTLHI register can be written. After this first instruction, hardware does not allow the upper five bits of this register to be written.

The TCTLHI bits for control of the WDT are described below:

WDT Time Select (D6, D5, D4). Bits 6, 5, and 4 determine the time-out period. Table 13 indicates the range of time-out values that can be obtained. The default values of D6, D5, and D4 are 001, which sets the WDT to its minimum time-out period when coming out of $\overline{\text{RESET}}$.

WDT During HALT (D7). This bit determines whether or not the WDT is active during HALT mode. A 1 indicates active during HALT mode. A 0 prevents the WDT from resetting the part while halted. Coming out of $\overline{\text{RESET}}$, the WDT is enabled during HALT mode.

STOP MODE (D3). Coming out of $\overline{\text{RESET}}$, the device STOP mode is disabled. If an application requires use of STOP mode, bit D3 must be cleared immediately at leaving $\overline{\text{RESET}}$. If bit D3 is set, the STOP instruction executes as a NOP. If bit D3 is cleared, the STOP instruction enters STOP mode.

Bits 2, 1 and 0. These bits are reserved and must be 0.

Table 13. WDT Time-Out

D6	D5	D4	Crystal Clocks* to Timeout	Time-Out Using a 10-MHz Crystal
0	0	0	Disabled	Disabled
0	0	1	65,536 TpC	6.55 ms
0	1	0	131,072 TpC	13.11 ms
0	1	1	262,144 TpC	26.21 ms
1	0	0	524,288 TpC	52.43 ms
1	0	1	1,048,576 TpC	104.86 ms
1	1	0	2,097,152 TpC	209.72 ms
1	1	1	8,388,608 TpC	838.86 ms

Note: *TpC is an XTAL clock cycle. The default at reset is 001.

POWER-DOWN MODES

In addition to the standard RUN mode, the Z8Plus MCU supports two Power-Down modes to minimize device cur-

rent consumption. The two modes supported are HALT and STOP.

HALT MODE OPERATION

The HALT mode suspends instruction execution and turns off the internal CPU clock. The on-chip oscillator circuit remains active so the internal clock continues to run and is applied to the timers and interrupt logic.

To enter HALT mode, the device only requires a HALT instruction. It is *not* necessary to execute a NOP instruction immediately before the HALT instruction.

```
7F HALT ; enter HALT mode
```

HALT mode can be exited by servicing an external or internal interrupt. The first instruction executed is the interrupt service routine. At completion of the interrupt service routine, the user program continues from the instruction after the HALT instruction.

The HALT mode can also be exited via a $\overline{\text{RESET}}$ activation or a Watch-Dog Timer (WDT) time-out. In these cases, program execution restarts at 0020H, the reset restart address.

STOP MODE OPERATION

The STOP mode provides the lowest possible device stand-by current. This instruction turns off the on-chip oscillator and internal system clock.

To enter the STOP mode, the Z8Plus only requires a STOP instruction. It is *not* necessary to execute a NOP instruction immediately before the STOP instruction.

```
6F  STOP  ;enter STOP mode
```

The STOP mode is exited by any one of the following resets: POR or a Stop-Mode Recovery source. At reset generation, the processor always restarts the application program at address 0020H, and the STOP mode flag is set. Reading the STOP mode flag does not clear it. The user must clear the STOP mode flag with software.

Note: Failure to clear the STOP mode flag can result in undefined behavior.

The Z8Plus provides a dedicated Stop-Mode Recovery (SMR) circuit. In this case, a low-level applied to input pin PB0 (I/O Port B, bit 0) triggers an SMR. To use this mode, pin PB0 must be configured as an input and the special function selected before the STOP mode is entered. The Low level on PB0 must be held for a minimum pulse width T_{WSM} . Program execution starts at address 20h, after the POR delay.

Notes: 1. The PB0 input, when used for Stop-Mode Recovery, does not initialize the control registers.

The STOP mode current (I_{CC2}) is minimized when:

- V_{CC} is at the low end of the device's operating range
- Output current sourcing is minimized
- All inputs (digital and analog) are at the Low or High rail voltages

2. For detailed information about flag settings, see the [Z8Plus User's Manual](#).

CLOCK

The Z8Plus MCU derives its timing from on-board clock circuitry connected to pins XTAL1 and XTAL2. The clock circuitry consists of an oscillator, a glitch filter, and a divide-by-two shaping circuit. Figure 12 illustrates the clock circuitry. The oscillator's input is XTAL1 and its output is XTAL2. The clock can be driven by a crystal, a ceramic resonator, LC clock, or an external clock source.

By selecting the RC OSCILLATOR option in the graphical user interface (GUI), the circuit may instead be driven by an external Resistor and Capacitor (RC) oscillator. Figure 13 illustrates this configuration. This design is limited to no more than 4 MHz to restrict EMI noise.

Note: The reduced drive strength of this configuration also allows the clock circuit to use a micropower-type crystal (also known as a tuning fork) without reduction resistors.



Figure 13. Z8Plus in RC Oscillator Mode



Figure 12. Clock Circuit

OSCILLATOR OPERATION

The Z8Plus MCU uses a Pierce oscillator with an internal feedback resistor (Figure 14). The advantages of this circuit are low-cost, large output signal, low-power level in the crystal, stability with respect to V_{CC} and temperature, and low impedances (not disturbed by stray effects).



Figure 14. Pierce Oscillator with Internal Feedback Circuit

One drawback to the Pierce oscillator is the requirement for high gain in the amplifier to compensate for feedback path losses. The oscillator amplifies its own noise at start-up until it settles at the frequency that satisfies the gain/phase requirements. $A \times B = 1$; where $A = V_O/V_I$ is the gain of the amplifier, and $B = V_I/V_O$ is the gain of the feedback element. The total phase shift around the loop is forced to 0 (360 degrees). V_{IN} must be in phase with itself; therefore, the amplifier/inverter provides a 180-degree phase shift, and the feedback element is forced to provide the other 180-degree phase shift.

R_1 is a resistive component placed from output to input of the amplifier. The purpose of this feedback is to bias the amplifier in its linear region and provide the start-up transition.

Capacitor C_2 , combined with the amplifier output resistance, provides a small phase shift. It also provides some attenuation of overtones.

Capacitor C_1 , combined with the crystal resistance, provides an additional phase shift.

Start-up time may be affected if C_1 and C_2 are increased dramatically in size. As C_1 and C_2 increase, the start-up time

increases until the oscillator reaches a point where it ceases to operate.

For fast and reliable oscillator start-up over the manufacturing process range, the load capacitors should be sized as low as possible without resulting in overtone operation.

Layout

Traces connecting crystal, caps, and the Z8Plus oscillator pins should be as short and wide as possible to reduce parasitic inductance and resistance. The components (caps, the crystal, and resistors) should be placed as close as possible to the oscillator pins of the Z8Plus.

The traces from the oscillator pins of the integrated circuit (IC) and the ground side of the lead caps should be guarded from all other traces (clock, V_{CC} , address/data lines, and system ground) to reduce cross talk and noise injection. Guarding is usually accomplished by keeping other traces and system ground trace planes away from the oscillator circuit, and by placing a Z8Plus device V_{SS} ground ring around the traces/components. The ground side of the oscillator lead caps should be connected to a single trace to the Z8Plus device V_{SS} (GND) pin. It should not be shared with any other system-ground trace or components except at the Z8Plus device V_{SS} pin. The objective is to prevent differential system ground noise injection into the oscillator (Figure 15).

Indications of an Unreliable Design

There are two major indicators that are used in working designs to determine their reliability over full lot and temperature variations. They are:

Start-Up Time. If start-up time is excessive, or varies widely from unit to unit, there is probably a gain problem. To fix the problem, the C_1 and C_2 capacitors require reduction. The amplifier gain is either not adequate at frequency, or the crystal R 's are too large.

Output Level. The signal at the amplifier output should swing from ground to V_{CC} to indicate adequate gain in the amplifier. As the oscillator starts up, the signal amplitude grows until clipping occurs. At that point, the loop gain is effectively reduced to unity, and constant oscillation is achieved. A signal of less than 2.5 volts peak-to-peak is an indication that low gain can be a problem. Either C_1 or C_2 should be made smaller, or a low-resistance crystal should be used.

OSCILLATOR OPERATION (Continued)

Circuit Board Design Rules

The following circuit board design rules are suggested:

- To prevent induced noise, the crystal and load capacitors should be physically located as close to the Z8Plus as possible.
- Signal lines should not run parallel to the clock oscillator inputs. In particular, the crystal input circuitry

and the internal system clock output should be separated as much as possible.

- V_{CC} power lines should be separated from the clock oscillator input circuitry.
- Resistivity between XTAL1 or XTAL2 (and the other pins) should be greater than 10 meg-Ohms.



Figure 15. Circuit Board Design Rules

Crystals and Resonators

Crystals and ceramic resonators (Figure 16) should exhibit the following characteristics to ensure proper oscillation:

Crystal Cut	AT (crystal only)
Mode	Parallel, fundamental mode
Crystal Capacitance	<7pF
Load Capacitance	10pF < CL < 220 pF, 15 typical
Resistance	100 Ohms maximum

Depending on the operation frequency, the oscillator may require additional capacitors, C_1 and C_2 , as illustrated in Figure 16 and Figure 17. The capacitance values are dependent on the manufacturer's crystal specifications.



Figure 16. Crystal/Ceramic Resonator Oscillator



Figure 17. LC Clock

In most cases, the R_D is 0 Ohms and R_F is infinite. These specifications are determined and specified by the crys-

tal/ceramic resonator manufacturer. The R_D can be increased to decrease the amount of drive from the oscillator output to the crystal. It can also be used as an adjustment to avoid clipping of the oscillator signal to reduce noise. The R_F can be used to improve the start-up of the crystal/ceramic resonator. The Z8Plus oscillator already locates an internal shunt resistor in parallel to the crystal/ceramic resonator.



Figure 18. External Clock

Figure 16, Figure 17, and Figure 18 recommend that the load capacitor ground trace connect directly to the V_{SS} (GND) pin of the Z8Plus. This requirement assures that no system noise is injected into the Z8Plus clock. This trace should not be shared with any other components except at the V_{SS} pin of the Z8Plus.

Note: A parallel-resonant crystal or resonator manufacturer specifies a load capacitor value that is a series combination of C_1 and C_2 , including all parasitics (PCB and holder).

LC OSCILLATOR

The Z8Plus oscillator can use an inductor capacitor oscillator (LC) network to generate an XTAL clock (Figure 17).

The frequency stays stable over V_{CC} and temperature. The oscillation frequency is determined by the equation:

$$\text{Frequency} = \frac{1}{2\pi (LC_T)^{1/2}}$$

where L is the total inductance including parasitics, and C_T is the total series capacitance including parasitics.

Simple series capacitance is calculated using the equation at the top of the next column.

$$\begin{aligned} 1/C_T &= 1/C_1 + 1/C_2 \\ \text{If } C_1 &= C_2 \\ 1/C_T &= 2/C_1 \\ C_1 &= 2C_T \end{aligned}$$

A sample calculation of capacitance C_1 and C_2 for 5.83-MHz frequency and inductance value of 27 μH is displayed as follows:

$$5.83 (10^6) = \frac{1}{2\pi [27 (10^{-6}) C_T]^{1/2}}$$

$$C_T = 27.6 \text{ pF}$$

Thus, $C_1 = 55.2 \text{ pF}$ and $C_2 = 55.2 \text{ pF}$.

TIMERS

Two 8-bit timers, timer 0 (T0) and timer 1 (T1) are available to function as a pair of independent 8-bit standard timers. They may also be cascaded to function as a 16-bit Pulse-

Width Modulator (PWM) timer. Two additional 8-bit timers (T2 and T3) are provided, but they can only operate as one 16-bit standard timer.



Figure 19. 16-Bit Standard Timer



Figure 20. 8-Bit Standard Timers

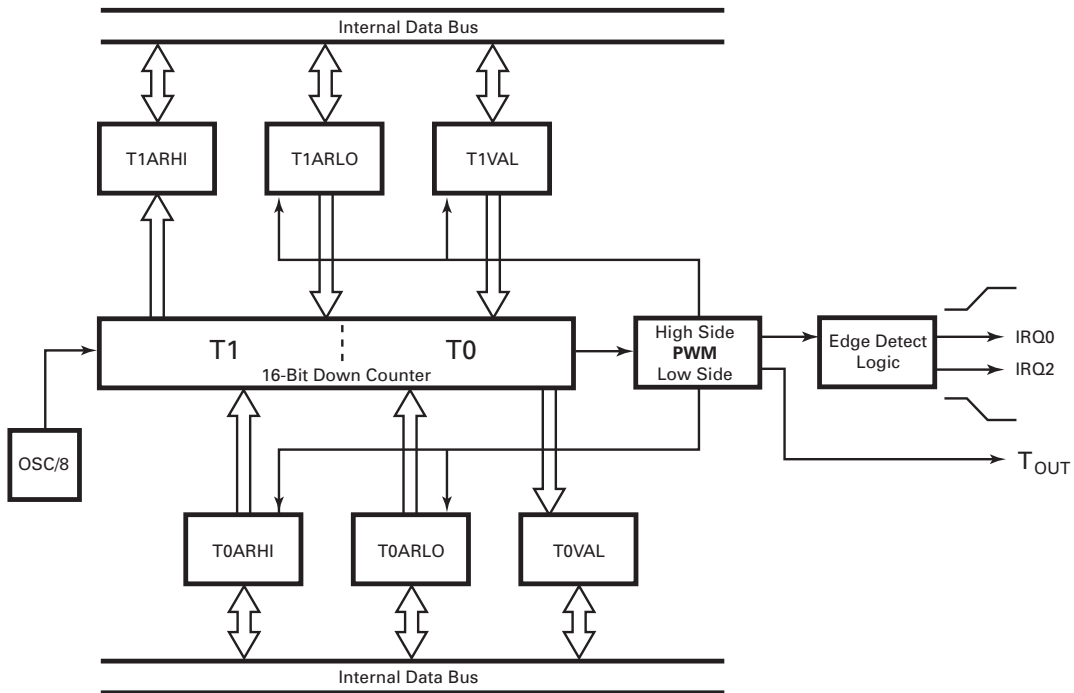
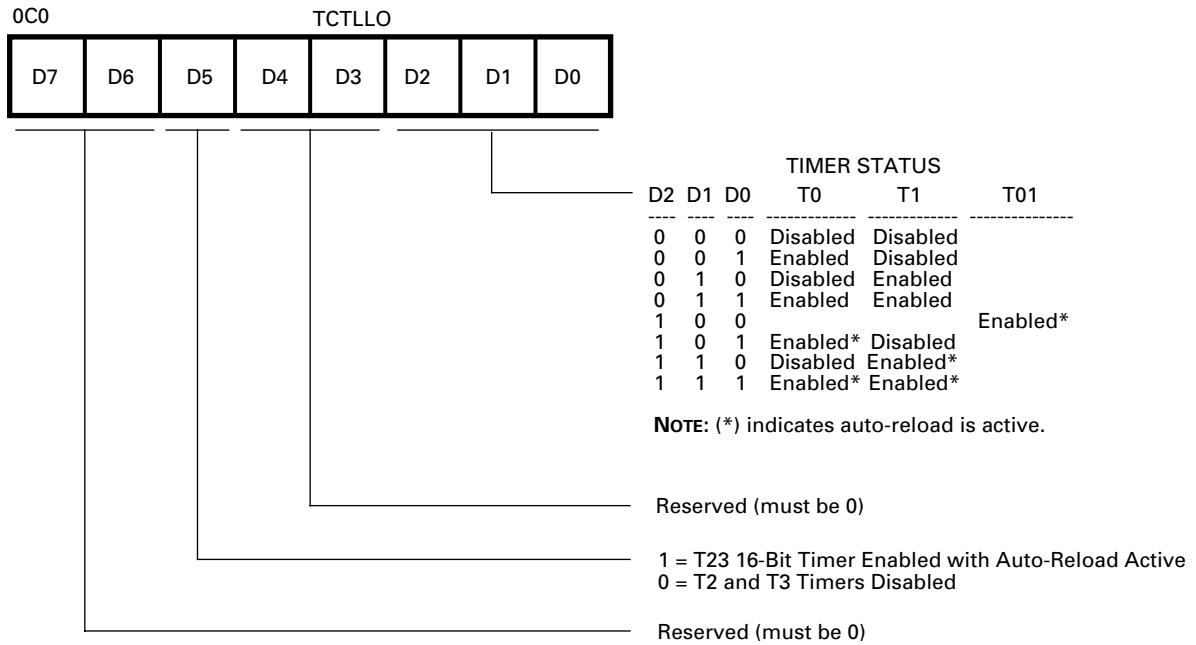

Figure 21. 16-Bit Standard PWM Timer

TIMERS (Continued)



Note: Timer T01 is a 16-bit PWM Timer formed by cascading 8-bit timers T1 (MSB) and T0 (LSB). T23 is a standard 16-bit timer formed by cascading 8-bit timers T3 (MSB) and T2 (LSB).

Figure 22. TCTLLO Register

A pair of READ/WRITE registers is utilized for each 8-bit timer. One register is defined to contain the auto-initialization value for the timer. The second register contains the current value for the timer. When a timer is enabled, the timer decrements the value in its count register and continues decrementing until it reaches 0. An interrupt is generated, and the contents of the auto-initialization register are optionally copied into the count value register. If auto-initialization is not enabled, the timer stops counting when the value reaches 0. Control logic clears the appropriate control register bit to disable the timer. This operation is referred to as a *single-shot*. If auto-initialization is enabled, the timer counts from the initialization value. Software must not attempt to use timer registers for any other function.

User software is allowed to write to any WRITE register at any time; however, care should be taken if timer registers are updated while the timer is enabled. If software changes the count value while the timer is in operation, the timer continues counting from the updated value.

Note: Unpredictable behavior can occur if the value updates at the same time that the timer reaches 0.

Similarly, if user software changes the initialization value register while the timer is active, the next time that the timer reaches 0, the timer initializes to the changed value.

Note: Unpredictable behavior can occur if the initialization value register is changed while the timer is in the process of being initialized.

The initialization value is determined by the exact timing of the WRITE operation. In all cases, the Z8Plus assigns a higher priority to the software WRITE than to a decremter write-back. However, when hardware clears a control register bit for a timer that is configured for single-shot operation, the clearing of the control bit overrides a software WRITE. A READ of either register can be conducted at any time, with no effect on the functionality of the timer.

If a timer pair is defined to operate as a single 16-bit entity, the entire 16-bit value must reach 0 before an interrupt is generated. In this case, a single interrupt is generated, and the interrupt corresponds to the even 8-bit timer.

Example: Timers T2 and T3 are cascaded to form a single 16-bit timer. The interrupt for the combined timer is defined to be generated by timer T2 rather than T3. When a timer pair is specified to act as a single 16-bit timer, the even timer registers in the pair (timer T0 or T2) is defined to hold the timer's least significant byte. In contrast, the odd timer in the pair holds the timer's most significant byte.

In parallel with the posting of the interrupt request, the interrupting timer's count value is initialized by copying the contents of the auto-initialization value register to the count value register.

Note: Any time that a timer pair is defined to act as a single 16-bit timer, the auto-reload function is performed automatically.

All 16-bit timers continue counting while their interrupt requests are active and operate independently of each other.

If interrupts are disabled for a long period of time, it is possible for the timer to decrement to 0 again before its initial interrupt is responded to. This condition is termed a degenerate case, and hardware is not required to detect it.

When the timer control register is written, all timers that are enabled by the WRITE begin counting from the value in the count register. In this case, an auto-initialization is not performed. All timers can receive an internal clock source input only. Each enabled timer is updated every 8th XTAL clock cycle.

If T0 and T1 are defined to work independently, then each works as an 8-bit timer with a single auto-initialization register (T0ARLO for T0, and T1ARLO for T1). Each timer asserts its predefined interrupt when it times out, optionally performing the auto-initialization function. If T0 and T1 are cascaded to form a single 16-bit timer, then the single 16-bit timer is capable of performing as a Pulse-Width Modulator (PWM). This timer is referred to as T01 to distinguish it as having special functionality that is not available when T0 and T1 act independently.

When T01 is enabled, it can use a pair of 16-bit auto-initialization registers. In this mode, one 16-bit auto-initial-

ization value is composed of the concatenation of T1ARLO and T0ARLO. The second auto-initialization value is composed of the concatenation of T1ARHI and T0ARHI. When T01 times out, it alternately initializes its count value using the Low auto-init pair, followed by the High auto-init pair. This functionality corresponds to a PWM. That is, the T1 interrupt defines the end of the High section of the waveform, and the T0 interrupt marks the end of the Low portion of the PWM waveform.

The PWM begins counting with whatever data is held in the count registers. After this value expires, the first reload depends on the state of the PB1 pin if T_{OUT} mode is selected. Otherwise, the Low value is applied first.

After the auto-initialization is completed, decrementing occurs for the number of counts defined by the PWM_LO registers. When decrementing again reaches 0, the T0 interrupt is asserted; and auto-init using the PWM_HI registers occurs. Decrementing occurs for the number of counts defined by the PWM_HI registers until reaching 0. From there, the T1 interrupt IRQ2 is asserted, and the cycle begins again.

The internal timers can be used to trigger external events by toggling the PB1 output when generating an interrupt. This functionality can only be achieved in conjunction with the port unit defining the appropriate pin as an output signal with the timer output special function enabled. In this mode, the port output is toggled when the timer count reaches 0, and continues toggling each time that the timer times out.

T_{OUT} Mode

The PortB special function register PTBSFR (0D7H; Figure 23) is used in conjunction with the Port B directional control register PTBDIR (0D6; Figure 24) to configure PB1 for T_{OUT} operation for T0. In order for T_{OUT} to function, PB1 must be defined as an output line by setting PTBDIR bit 1 to 1. Configured in this way, PB1 is capable of being a clock output for T0, toggling the PB1 output pin on each T0 time-out.

At end-of-count, the interrupt request line (IRQ0), clocks a toggle flip-flop. The output of this flip-flop drives the T_{OUT} line, PB1. In all cases, when T0 reaches its end-of-count, T_{OUT} toggles to its opposite state (Figure 25). If, for example, T0 is in Continuous Counting Mode, T_{OUT} exhibits a 50-percent duty cycle output. If the timer pair is selected (T01) as a PWM, the duty cycle depends on the High and Low reload values. At the end of each High time, PB1 toggles Low. At the end of each Low time, PB1 toggles HI.

TIMERS (Continued)

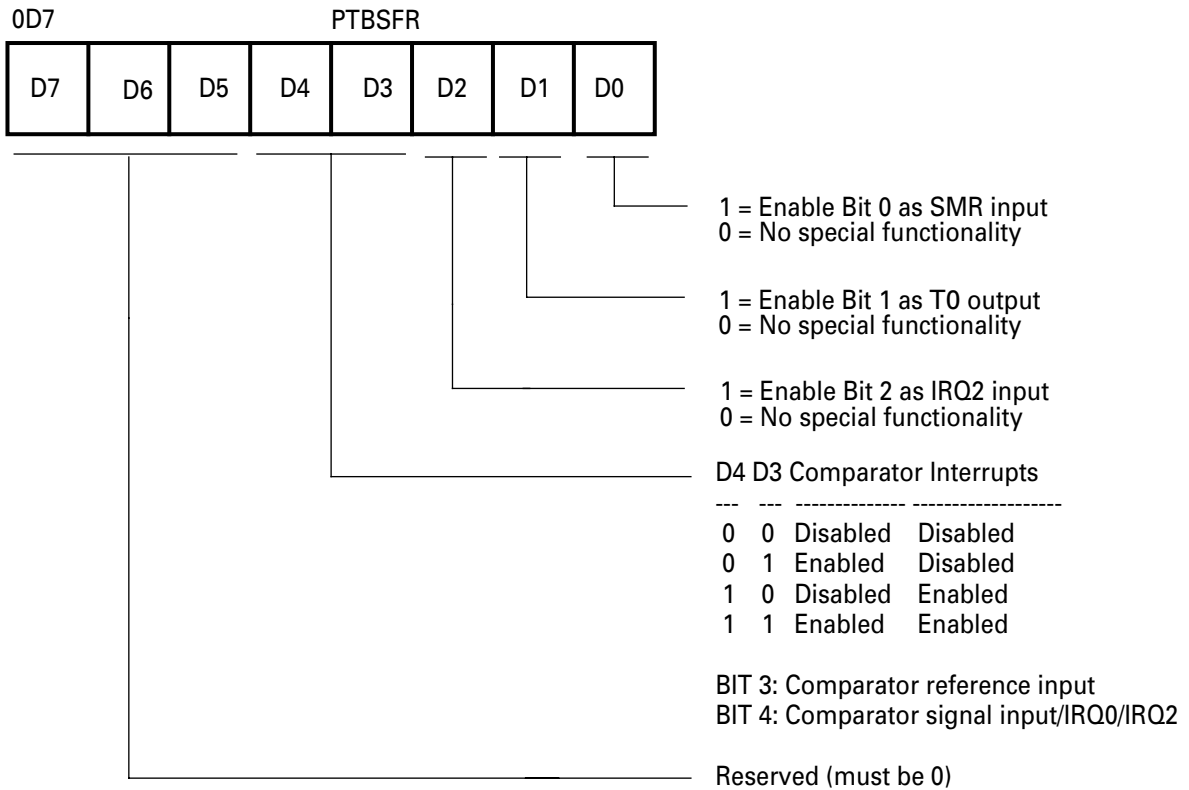

Figure 23. PortB Special Function Register



Figure 24. Port B Directional Control Register



Figure 25. Timer T0 Output Through T_{OUT}

RESET CONDITIONS

After a $\overline{\text{RESET}}$, the timers are disabled. See Table 8 for timer control, value, and auto-initialization register status after $\overline{\text{RESET}}$.

I/O PORTS

The Z8Plus dedicates 14 lines to input and output. These lines are grouped into two ports known as Port A and Port B. Port A is an 8-bit port, bit programmable as either inputs or outputs. Port B can be programmed to provide either standard input/output, or the following special functions: T0 output, comparator input, SMR input, and external interrupt inputs.

All pins except PB5 include push-pull CMOS outputs. In addition, the outputs of Port A on a bit-wise basis can be configured for open-drain operation. The ports operate on a bit-wise basis. As such, the register values for/at a given bit position only affect the bit in question.

Each port is defined by a set of four control registers (Figure 26).



Figure 26. Port A Configuration with Open-Drain Capability and Schmitt-Trigger

Directional Control and Special Function Registers

Each port on the Z8Plus features a dedicated directional control register that determines (on a bit-wise basis) if a given port bit operates as input or output.

Each port on the Z8Plus features a special function register (SFR) that, in conjunction with the directional control register, implements (on a bit-by-bit basis) any special functionality that can be defined for each particular port bit.

Table 14. I/O Ports Registers

Register	Address	Identifier
Port B Special Function	0D7H	PTBSFR
Port B Directional Control	0D6H	PTBDIR
Port B Output Value	0D5H	PTBOUT
Port B Input Value	0D4H	PTBIN
Port A Special Function	0D3H	PTASFR
Port A Directional Control	0D2H	PTADIR
Port A Output Value	0D1H	PTAOUT
Port A Input Value	0D0H	PTAIN

Input and Output Value Registers

Each port features an Output Value Register and an input value register. For port bits configured as an input by means of the directional control register, the input value register

for that bit position contains the current synchronized input value.

For port bits configured as an output by means of the directional control register, the value held in the corresponding bit of the Output Value Register is driven directly onto

the output pin. The opposite register bit for a given pin (the output register bit for an input pin and the input register bit for an output pin) holds their previous value. These bits are not changed and do not exhibit any effect on the hardware.

READ/WRITE OPERATIONS

The control for each port is done on a bit-by-bit basis. All bits are capable of operating as inputs or outputs, depending on the setting of the port's directional control register. If configured as an input, each bit is provided a Schmitt-trigger. The output of the Schmitt-trigger is latched twice to perform a synchronization function, and the output of the synchronizer is fed to the port input register, which can be read by software.

A WRITE to a port input register carries the effect of updating the contents of the input register, but subsequent READs do not necessarily return the same value that was written. If the bit in question is defined as an input, the input register for that bit position contains the current synchronized input value. WRITEs to that bit position are overwritten on the next clock cycle with the newly sampled input data. However, if the particular bit is programmed as an output, the input register for that bit retains the software-updated value. The port bits that are programmed as outputs do not sample the value being driven out.

Any bit in either port can be defined as an output by setting the appropriate bit in the directional control register. In this instance, the value held in the appropriate bit of the port output register is driven directly onto the output pin.

Note: The preceding result does not necessarily reflect the actual output value. If an external error is holding an output pin either High or Low against the output driver, the software READ returns the *requested* value, not the actual state caused by the contention. When a bit is defined as an output, the Schmitt-trigger on the input is disabled to save power.

Updates to the output register take effect based on the timing of the internal instruction pipeline; however, this timing is referenced to the rising edge of the clock. The output register can be read at any time, and returns the current output value that is held. No restrictions are placed on the timing of READs and/or WRITEs to any of the port registers with respect to the others.

Note: Care should be taken when updating the directional control and special function registers.

When updating a directional control register, the special function register (SFR) should first be disabled. If this precaution is not taken, unpredicted events could occur as a result of the change in the port I/O status. This precaution is especially important when defining changes in Port B, as the unpredicted event referred to above could be one or more interrupts. Clearing of the SFR register should be the first step in configuring the port, while setting the SFR register should be the final step in the port configuration process. To ensure unpredictable results, the SFR register should not be written until the pins are being driven appropriately, and all initialization is completed.

PORT A

Port A is a general-purpose port. Figure 27 features a block diagram of Port A. Each of its lines can be independently programmed as input or output via the Port A directional control register (PTADIR at 0D2H) as seen in Figure 26. A bit set to a 1 in PTADIR configures the corresponding bit in Port A as an output, while a bit cleared to 0 configures the corresponding bit in Port A as an input.

The input buffers are Schmitt-triggered. Bits programmed as outputs can be individually programmed as either push-

pull or open-drain by setting the corresponding bit in the special function register (PTASFR, Figure 26).



Figure 27. Port A Directional Control Register

PORT A REGISTER DIAGRAMS

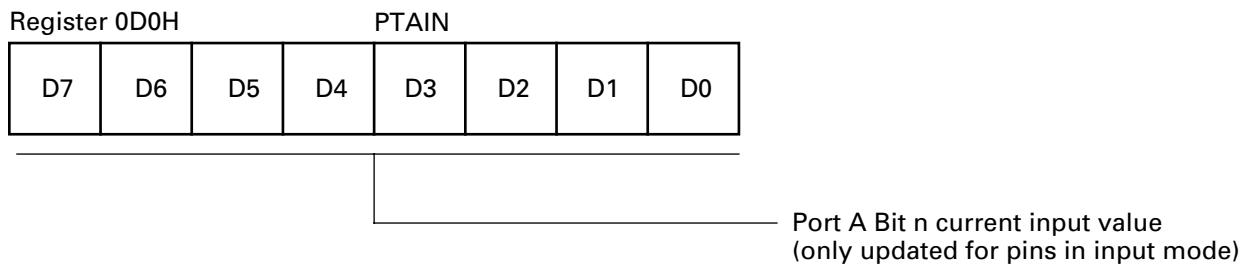

Figure 28. Port A Input Value Register

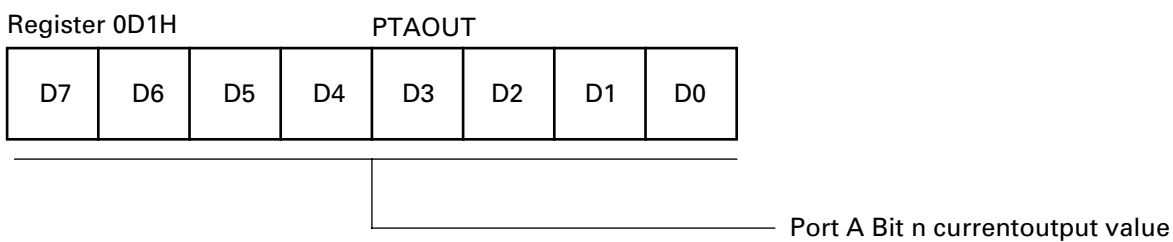

Figure 29. Port A Output Value Register



Figure 30. Port A Directional Control Register



Figure 31. Port A Special Function Register

PORT B

Port B Description

Port B is a 6-bit (bidirectional), CMOS-compatible I/O port. These six I/O lines can be configured under software control to be an input or output. Each bit is configured independently from the other bits. That is, one bit may be set to INPUT while another bit is set to OUTPUT.

In addition to standard input/output capability, five pins of Port B provide special functionality as indicated in Table 15.

Special functionality is invoked via the Port B special function register. Port B, bit 5, is an open-drain-only pin when in output mode. There is no high-side driver on the output stage, nor is there any high-side protection device, because PB5 acts as the V_{PP} pin for EPROM programming mode. The user should always place an external protection diode on this pin. See Figure 32.

Table 15. Port B Special Functions

Port Pin	Input Special Function	Output Special Function
PB0	Stop Mode Recovery Input	None
PB1	None	T0 Output
PB2	IRQ3	None
PB3	Comparator Reference Input	None
PB4	Comparator Signal Input/IRQ1/IRQ4	None

Register 0D7H

PTBSFR

D7	D6	D5	D4	D3	D2	D1	D0
----	----	----	----	----	----	----	----



Figure 32. Port B Special Function Register

PORT B—PIN 0 CONFIGURATION



Figure 33. Port B Pin 0 Diagram



Note: There is no high-side protection device. The user should always place an external protection diode as shown.

Figure 34. Port B Pin 5 Diagram

PORT B—PIN 1 CONFIGURATION



Figure 35. Port B Pin 1 Diagram

PORT B—PIN 2 CONFIGURATION



Figure 36. Port B Pin 2 Diagram

PORT B—PINS 3 AND 4 CONFIGURATION



Figure 37. Port B Pins 3 and 4 Diagram

PORT B CONTROL REGISTERS

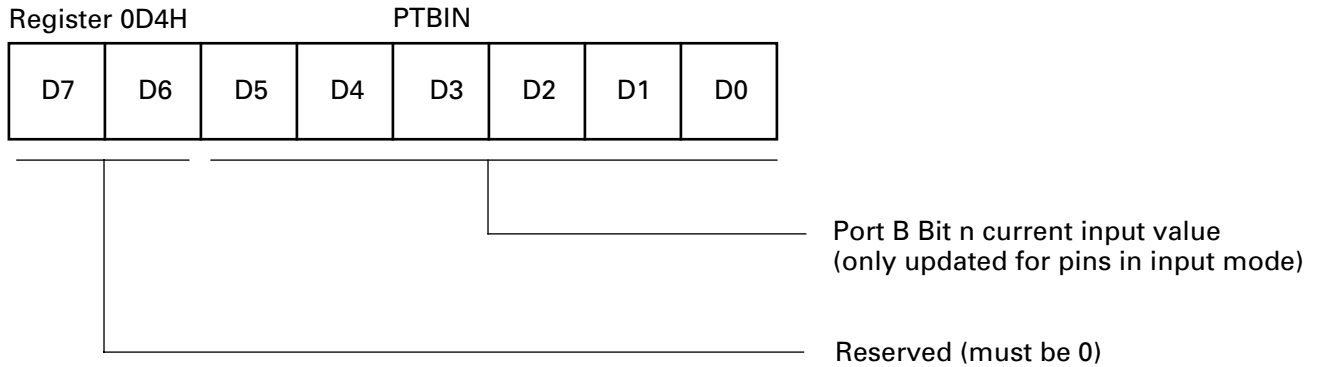

Figure 38. Port B Input Value Register



Figure 39. Port B Output Value Register

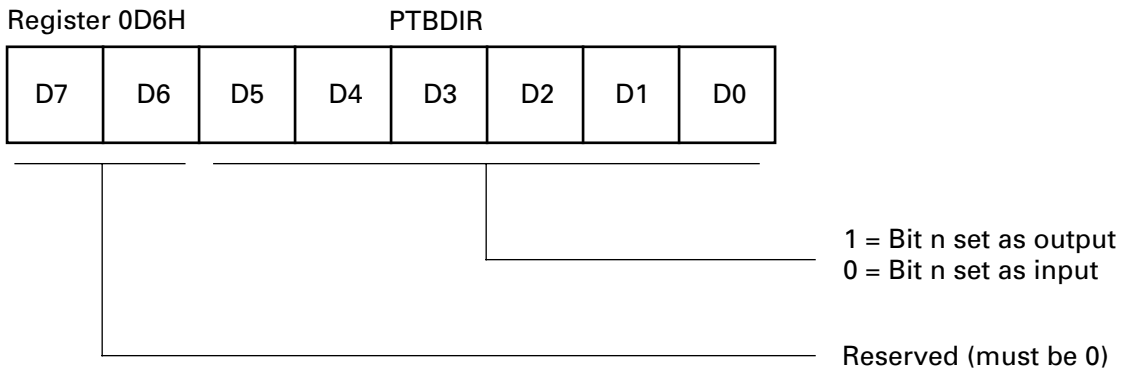

Figure 40. Port B Directional Control Register

PORT B CONTROL REGISTERS (Continued)

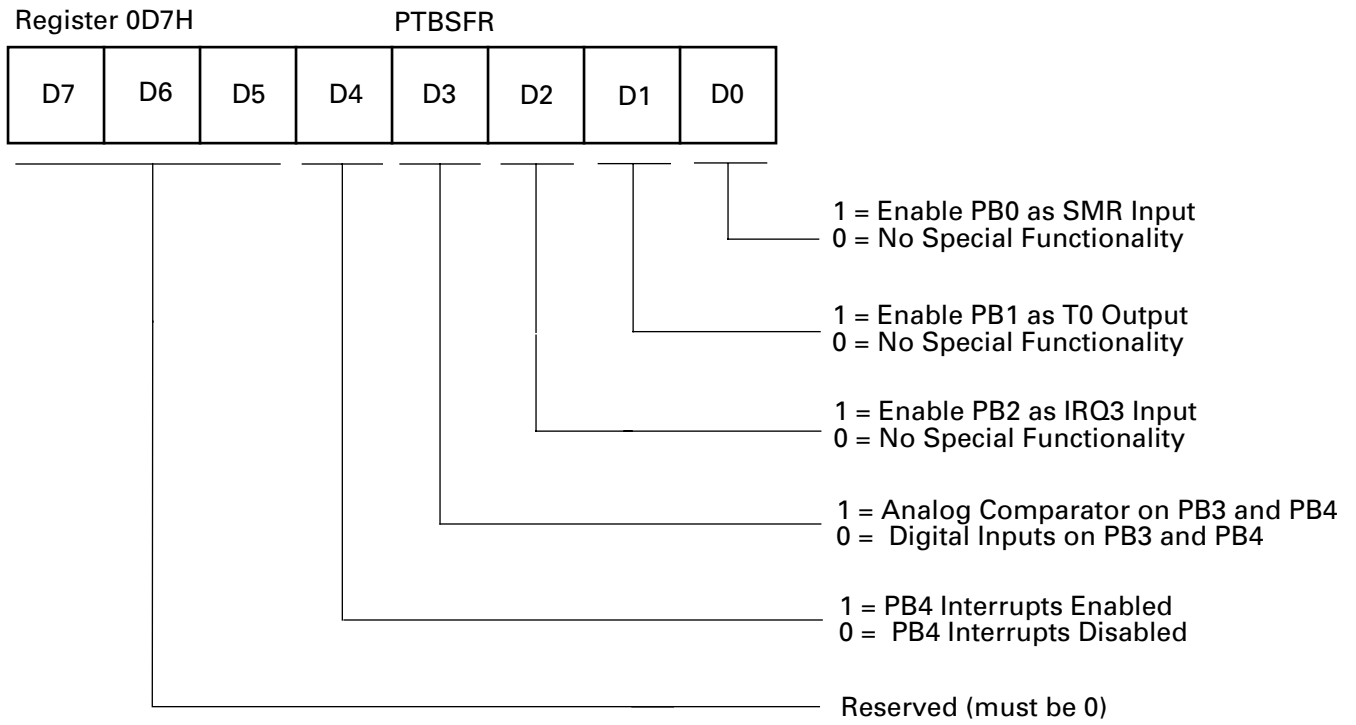

Figure 41. Port B Special Function Register

I/O PORT RESET CONDITIONS

Full Reset

Port A and Port B output value registers are not affected by $\overline{\text{RESET}}$.

On $\overline{\text{RESET}}$, the Port A and Port B directional control registers are cleared to all zeros, which defines all pins in both ports as inputs.

On $\overline{\text{RESET}}$, the directional control registers redefine all pins as inputs, and the Port A and Port B input value registers

overwrites the previously held data with the current sample of the input pins.

On $\overline{\text{RESET}}$, the Port A and Port B special function registers are cleared to 00h, which deactivates all port special functions.

Note: The SMR and WDT time-out events are *not* full device resets. The port control registers are not affected by either of these events.

ANALOG COMPARATOR

The device includes one on-chip analog comparator. Pin PB4 features a comparator front end. The comparator reference voltage is on pin PB3.

Comparator Description

The on-chip comparator can process an analog signal on PB4 with reference to the voltage on PB3. The analog function is enabled by programming the Port B special function register bits 3 and 4.

When the analog comparator function is enabled, bit 4 of the input register is defined as holding the synchronized output of the comparator, while bit 3 retains a synchronized sample of the reference input.

If the interrupts for PB4 are enabled when the comparator special function is selected, the output of the comparator generates interrupts.

COMPARATOR OPERATION

The comparator output reflects the relationship between the analog input to the reference input. If the voltage on the analog input is higher than the voltage on the reference input, then the comparator output is at a High state. If the voltage on the analog input is lower than the voltage on the reference input, then the analog output is at a Low state.

Comparator Definitions

V_{ICR}

The usable voltage range for the positive input and reference input is called the Comparator Input Common Mode Voltage Range (V_{ICR}).

Note: The comparator is not guaranteed to work if the input is outside of the V_{ICR} range.

V_{OFFSET}

The absolute value of the voltage between the positive input and the reference input required to make the comparator output voltage switch is the Comparator Input Offset Voltage (V_{OFFSET}).

I_{IO}

For the CMOS voltage comparator input, the input offset current (I_{IO}) is the leakage current of the CMOS input gate.

HALT Mode

The analog comparator is functional during HALT mode. If the interrupts are enabled, an interrupt generated by the comparator causes a return from HALT mode.

STOP Mode

The analog comparator is disabled during STOP mode. The comparator is powered down to prevent it from drawing any current.

Low Voltage Protection. An on-board Voltage Comparator checks that the V_{CC} is at the required level to ensure correct operation of the device. A reset is globally driven if V_{CC} is below the specified voltage (Low Voltage Protection).

The device functions normally at or above 3.0V under all conditions, and is guaranteed to function normally at supply voltages above the Low Voltage Protection trip point. Below 3.0V, the device functions normally until the Low Volt-

COMPARATOR OPERATION (Continued)

age Protection trip point (V_{LV}) is reached. The actual Low-Voltage Protection trip point is a function of process parameters.

Low-Voltage Protection is active in RUN and HALT modes only, but is disabled in STOP mode (Figure 42).



Figure 42. Typical Low Voltage Protection vs. Temperature

INPUT PROTECTION

All I/O pins feature diode input protection. There is a diode from the I/O pad to V_{CC} and V_{SS} (Figure 43).



Figure 43. I/O Pin Diode Input Protection

However, the PB5 pin features only the input protection diode, from the pad to V_{SS} (Figure 44).

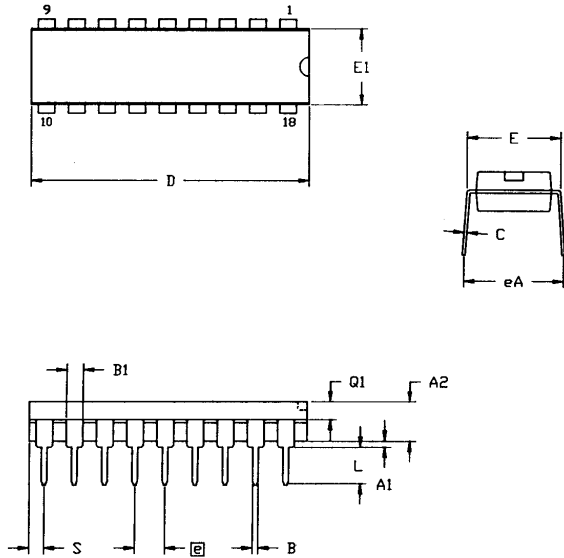

Figure 44. PB5 Pin Input Protection

The high-side input protection diode was removed on this pin to allow the application of high voltage during the OTP programming mode.

For better noise immunity in applications that are exposed to system EMI, a clamping diode to V_{SS} from this pin should be used to prevent entering the OTP programming mode or to prevent high voltage from damaging this pin.

PACKAGE INFORMATION



SYMBOL	MILLIMETER		INCH	
	MIN	MAX	MIN	MAX
A1	0.51	0.81	.020	.032
A2	3.25	3.43	.128	.135
B	0.38	0.53	.015	.021
B1	1.14	1.65	.045	.065
C	0.23	0.38	.009	.015
D	22.35	23.37	.880	.920
E	7.62	8.13	.300	.320
E1	6.22	6.48	.245	.255
Ⓢ	2.54 TYP		.100 TYP	
eA	7.87	8.89	.310	.350
L	3.18	3.81	.125	.150
Q1	1.52	1.65	.060	.065
S	0.89	1.65	.035	.065

CONTROLLING DIMENSIONS : INCH

Figure 45. 18-Pin DIP Package Diagram



SYMBOL	MILLIMETER		INCH	
	MIN	MAX	MIN	MAX
A	2.40	2.65	0.094	0.104
A1	0.10	0.30	0.004	0.012
A2	2.24	2.44	0.088	0.096
B	0.36	0.46	0.014	0.018
C	0.23	0.30	0.009	0.012
D	11.40	11.75	0.449	0.463
E	7.40	7.60	0.291	0.299
Ⓢ	1.27 TYP		0.050 TYP	
H	10.00	10.65	0.394	0.419
h	0.30	0.50	0.012	0.020
L	0.60	1.00	0.024	0.039
Q1	0.97	1.07	0.038	0.042

CONTROLLING DIMENSIONS : MM
LEADS ARE COPLANAR WITHIN .004 INCH.

Figure 46. 18-Pin SOIC Package Diagram



SYMBOL	MILLIMETER			INCH		
	MIN	NOM	MAX	MIN	NOM	MAX
A	1.73	1.85	1.98	0.068	0.073	0.078
A1	0.05	0.13	0.21	0.002	0.005	0.008
A2	1.68	1.73	1.83	0.066	0.068	0.072
B	0.25	0.30	0.38	0.010	0.012	0.015
C	0.13	0.15	0.22	0.005	0.006	0.009
D	7.07	7.20	7.33	0.278	0.283	0.289
E	5.20	5.30	5.38	0.205	0.209	0.212
ⓐ	0.65 TYP			0.0256 TYP		
H	7.65	7.80	7.90	0.301	0.307	0.311
L	0.56	0.75	0.94	0.022	0.030	0.037
Q1	0.74	0.78	0.82	0.029	0.031	0.032

Figure 47. 20-Pin SSOP Package Diagram

ORDERING INFORMATION

Standard Temperature

18-Pin DIP	Z8PE003PZ010SC
18-Pin SOIC	Z8PE003SZ010SC
20-Pin SSOP	Z8PE003HZ010SC

Extended Temperature

18-Pin DIP	Z8PE003PZ010EC
18-Pin SOIC	Z8PE003SZ010EC
20-Pin SSOP	Z8PE003CZ010EC

For fast results, contact your local ZiLOG sales office for assistance in ordering the part(s) required.

Codes

Preferred Package	PZ = Plastic DIP
Longer Lead Time	SZ = SOIC HZ = SSOP
Speed	010 = 10 MHz
Standard Temperature	S = 0°C to +70°C
Extended Temperature	E = -40°C to +105°C
Environmental Flow	C = Plastic Standard

Example:

The Z8PE003PZ010SC is a 10-MHz DIP, 0°C to 70°C, with Plastic Standard Flow.

Z	ZiLOG Prefix
8PE	Z8Plus Product
003	Product Number
PZ	Package Designation Code
010	Speed
SC	Temperature and Environmental Flow

Pre-Characterization Product:

The product represented by this document is newly introduced and ZiLOG has not completed the full characterization of the product. The document states what ZiLOG knows about this product at this time, but additional features or non-conformance

with some aspects of the document may be found, either by ZiLOG or its customers in the course of further application and characterization work. In addition, ZiLOG cautions that delivery may be uncertain at times, due to start-up yield issues.

©1999 by ZiLOG, Inc. All rights reserved. Information in this publication concerning the devices, applications, or technology described is intended to suggest possible uses and may be superseded. ZiLOG, INC. DOES NOT ASSUME LIABILITY FOR OR PROVIDE A REPRESENTATION OF ACCURACY OF THE INFORMATION, DEVICES, OR TECHNOLOGY DESCRIBED IN THIS DOCUMENT. ZiLOG ALSO DOES NOT ASSUME LIABILITY FOR INTELLECTUAL PROPERTY INFRINGEMENT RELATED IN ANY MANNER TO USE OF INFORMATION, DEVICES, OR TECHNOLOGY DESCRIBED HEREIN OR OTHERWISE. Except with the express written approval of ZiLOG, use of information, devices, or technology as critical components of

life support systems is not authorized. No licenses are conveyed, implicitly or otherwise, by this document under any intellectual property rights.

ZiLOG, Inc.
910 East Hamilton Avenue, Suite 110
Campbell, CA 95008
Telephone (408) 558-8500
FAX 408 558-8300
Internet: <http://www.zilog.com>

Данный компонент на территории Российской Федерации

Вы можете приобрести в компании MosChip.

Для оперативного оформления запроса Вам необходимо перейти по данной ссылке:

<http://moschip.ru/get-element>

Вы можете разместить у нас заказ для любого Вашего проекта, будь то серийное производство или разработка единичного прибора.

В нашем ассортименте представлены ведущие мировые производители активных и пассивных электронных компонентов.

Нашей специализацией является поставка электронной компонентной базы двойного назначения, продукции таких производителей как XILINX, Intel (ex.ALTERA), Vicor, Microchip, Texas Instruments, Analog Devices, Mini-Circuits, Amphenol, Glenair.

Сотрудничество с глобальными дистрибьюторами электронных компонентов, предоставляет возможность заказывать и получать с международных складов практически любой перечень компонентов в оптимальные для Вас сроки.

На всех этапах разработки и производства наши партнеры могут получить квалифицированную поддержку опытных инженеров.

Система менеджмента качества компании отвечает требованиям в соответствии с ГОСТ Р ИСО 9001, ГОСТ РВ 0015-002 и ЭС РД 009

Офис по работе с юридическими лицами:

105318, г.Москва, ул.Щербаковская д.3, офис 1107, 1118, ДЦ «Щербаковский»

Телефон: +7 495 668-12-70 (многоканальный)

Факс: +7 495 668-12-70 (доб.304)

E-mail: info@moschip.ru

Skype отдела продаж:

moschip.ru

moschip.ru_4

moschip.ru_6

moschip.ru_9