

Agilent HDSP-331x/332E/333x/334x Series 7.62 mm (0.3 inch) General Purpose Seven-Segment Display Data Sheet

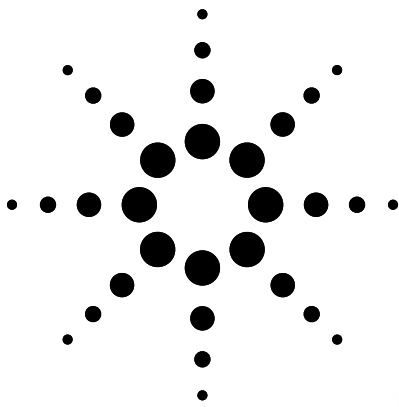

Description

This 7.62 mm (0.3 inch) LED seven-segment display uses industry standard size package and pinout. The device is available in either common anode

or common cathode. The choice of colors includes High Efficiency Red (HER), Green, AlGaAs Red, and Yellow. The gray face displays are suitable for indoor use.

Features

- **Industry standard size**
- **Industry standard pinout**
7.62 mm (0.4 inch) character height
DIP lead on 2.54 mm
- **Choice of colors**
High Efficiency Red (HER), Green, AlGaAs Red, and Yellow
- **Excellent appearance**
Evenly lighted segments gray package gives optimum contrast
 $\pm 50^\circ$ viewing angle
- **Design flexibility**
Common anode or common cathode
Single digit
Left and right hand decimal point
- **Categorized for luminous intensity**
Green and yellow categorized for color

Applications

- **Suitable for indoor use**
- **Not recommended for industrial application, i.e., operating temperature requirements exceeding $+85^\circ\text{C}$ or below -25°C ^[1]**
- **Extreme temperature cycling not recommended**

Note:

1. For additional details, please contact your local Agilent sales office or an authorized distributor.

Devices

HER	Green	AlGaAs Red	Yellow	Description	Package Drawing
HDSP-331E	HDSP-331G	HDSP-331A	HDSP-331Y	Common Anode, Right Hand and Left Hand Decimal	A
HDSP-332E				Common Anode, Right Hand and Left Hand Decimal without Pin 4, 5 and 12	A
HDSP-333E	HDSP-333G	HDSP-333A	HDSP-333Y	Common Cathode, Right Hand Decimal	B
HDSP-334E	HDSP-334G	HDSP-334A	HDSP-334Y	Common Cathode, Right Hand Decimal	C



Part Numbering System

5082 -X X X X-X X X X X

HDSP-X X X X-X X X X X

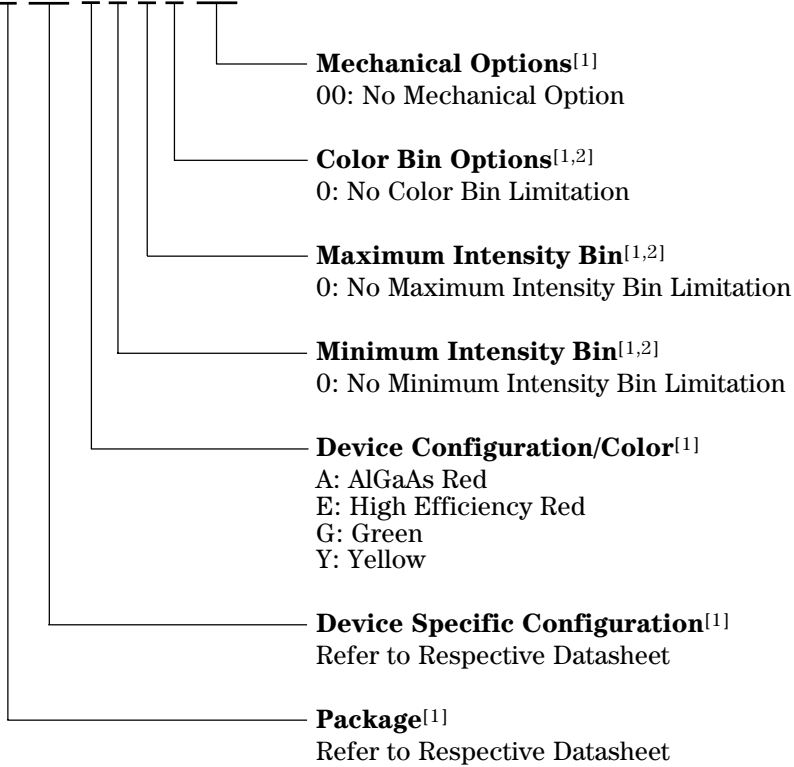

Notes:

1. For codes not listed in the figure above, please refer to the respective datasheet or contact your nearest Agilent representative for details.
2. Bin options refer to shippable bins for a part number. Color and Intensity Bins are typically restricted to 1 bin per tube (exceptions may apply). Please refer to respective datasheet for specific bin limit information.

Package Dimensions

Package Drawing A

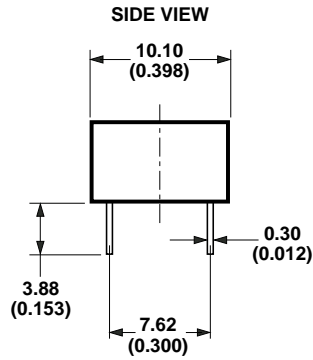
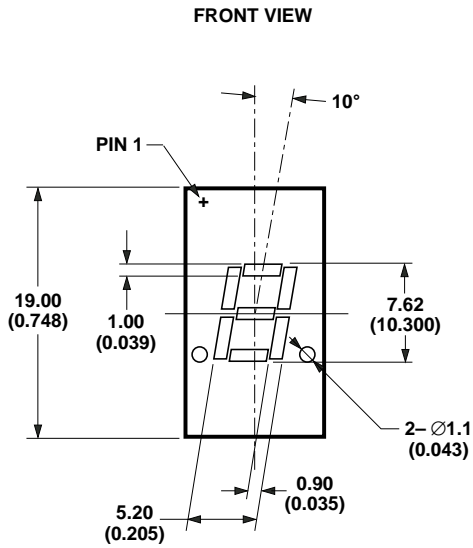

NOTE: HDSP-332E DOES NOT HAVE PIN 4, 5 AND 12.

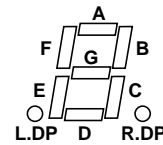
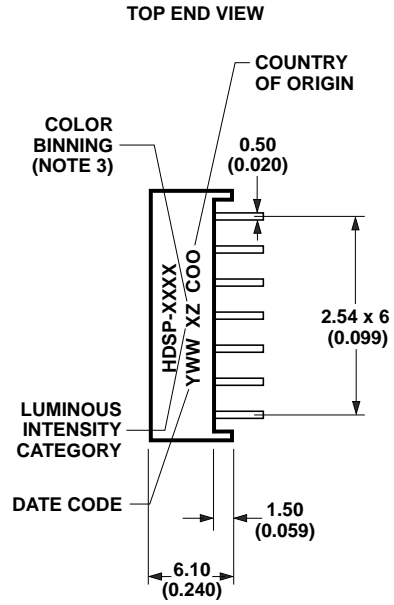

DIMENSIONS IN MILLIMETERS (INCHES)

Package Dimensions

Package Drawing B

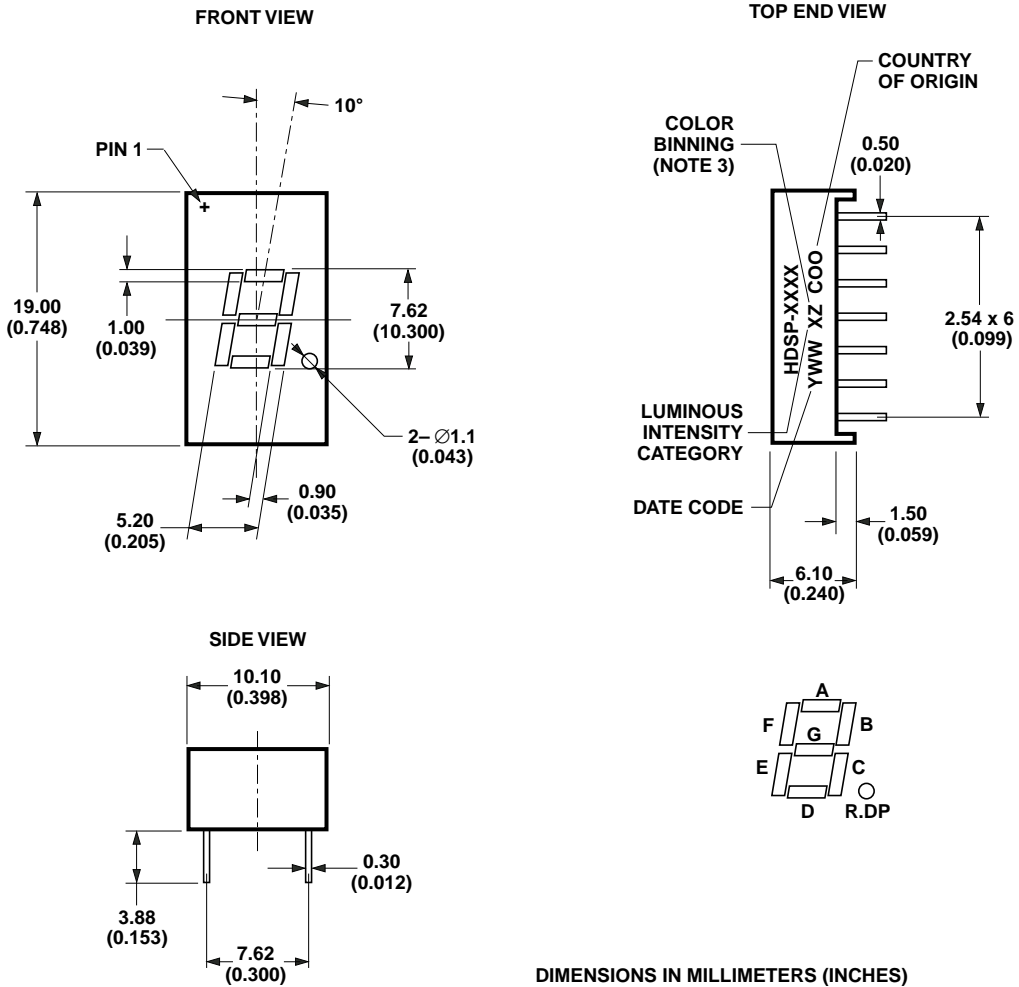

DIMENSIONS IN MILLIMETERS (INCHES)

Package Dimensions

Package Drawing C

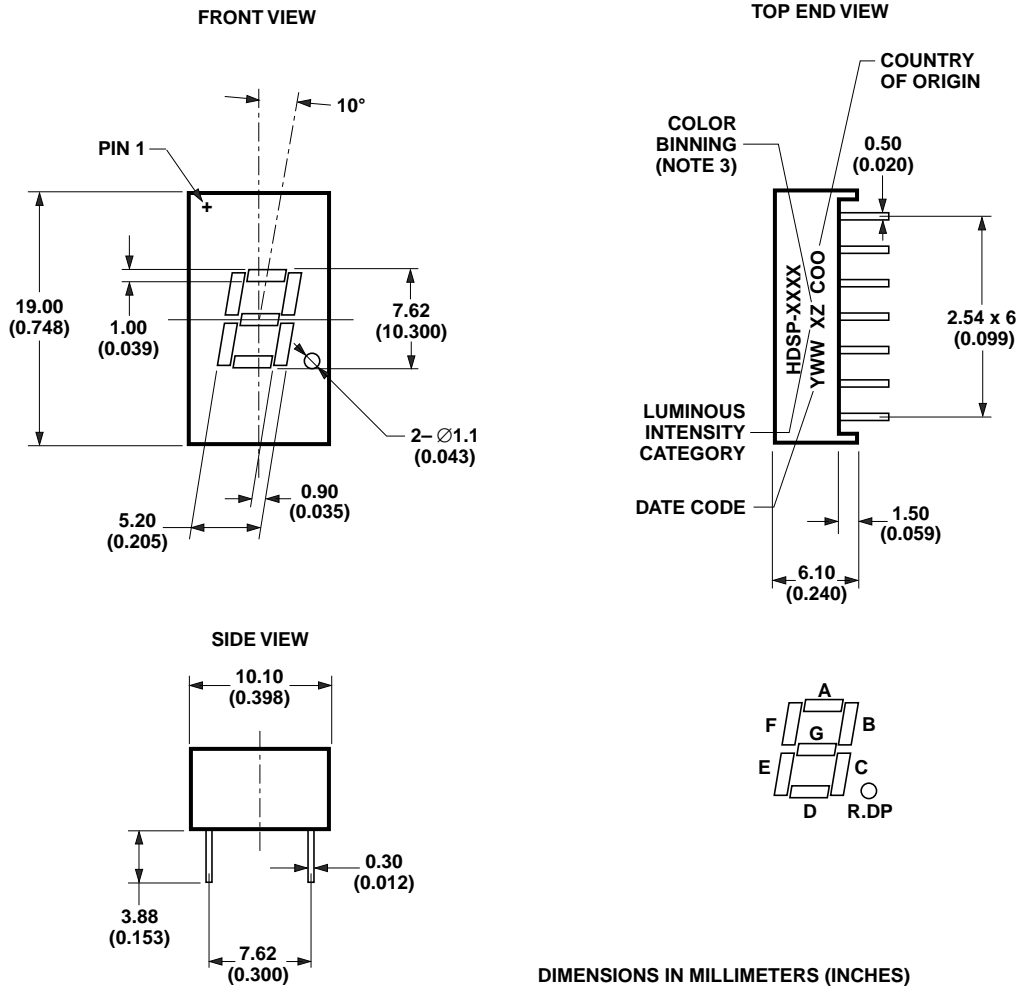

DIMENSIONS IN MILLIMETERS (INCHES)

Internal Circuit Diagram

Common Anode

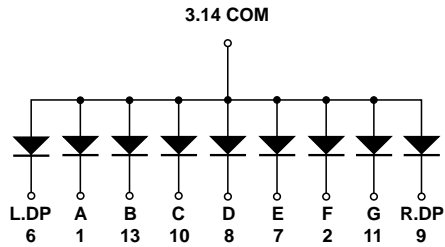

HDSP-331E/331G/331Y/331A/332E

PIN NO.	CONNECTION
1	CATHODE A
2	CATHODE F
3	COMMON ANODE
6	CATHODE L.DP
7	CATHODE E
8	CATHODE D
9	CATHODE R.DP
10	CATHODE C
11	CATHODE G
13	CATHODE B
14	COMMON ANODE
PINS 4, 5, 12: NO CONNECTION FOR HDSP-331E/331G/331Y/331A AND NO PIN FOR HDSP-332E	

Common Cathode

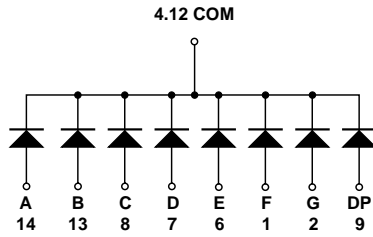

HDSP-333E/333G/333Y/333A

PIN NO.	CONNECTION
1	ANODE F
2	ANODE G
4	COMMON CATHODE
6	ANODE E
7	ANODE D
8	ANODE C
9	ANODE DP
12	COMMON CATHODE
13	ANODE B
14	ANODE A
PINS 3, 5, 10, 11: NC	

Internal Circuit Diagram

Common Cathode

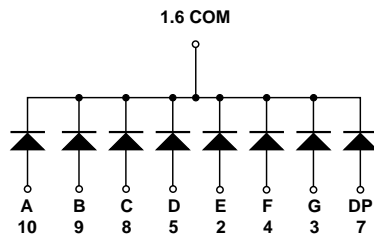

HDSP-334E/334G/334Y/334A

PIN NO.	CONNECTION
1	COMMON CATHODE
2	ANODE E
3	ANODE G
4	ANODE F
5	ANODE D
6	COMMON CATHODE
7	ANODE DP
8	ANODE C
9	ANODE B
10	ANODE A
PINS 11, 12, 13, 14: NC	

Absolute Maximum Ratings at T_A = 25 °C

Description	HER HDSP-33xE	Green HDSP-33xG	AlGaAs Red HDSP-33xA	Yellow HDSP-33xY	Units
Power Dissipation Segment	65	65	30	52	mW
Forward Current Segment	25 ^[1]	25 ^[2]	15 ^[3]	20 ^[4]	mA
Peak Forward Current per Segment (1/10 Duty Factor at 10 kHz)	100	100	80	80	mA
Operating Temperature Range	-35 to +85	-35 to +85	-35 to +85	-35 to +85	°C
Storage Temperature Range	-35 to +85	-35 to +85	-35 to +85	-35 to +85	°C
Reverse Voltage per Segment or DP	5	5	5	5	V
Wave Soldering Temperature for 3 Seconds (at 2 mm Distance from the Body)	250	250	250	250	°C

Notes:

1. Derate above 25 °C at 0.33 mA/°C.
2. Derate above 25 °C at 0.33 mA/°C.
3. Derate above 25 °C at 0.2 mA/°C.
4. Derate above 25 °C at 0.27 mA/°C.

Electrical/Optical Characteristics at T_A = 25 °C

High Efficiency Red (HER)

Devices							
HDSP-	Parameter	Symbol	Min.	Typ.	Max.	Units	Test Conditions
	Luminous Intensity/Segment	I _V		1.15		mcd	I _F = 5 mA
			0.8	1.80		mcd	I _F = 10 mA
331E	Forward Voltage	V _F		2.05	2.40	V	I _F = 20 mA
332E	Peak Wavelength	λ _{PEAK}		635		nm	
333E	Dominant Wavelength	λ _d		620		nm	
334E	Reverse Voltage	VR	5			V	I _R = 100 μA

Green

Devices							
HDSP-	Parameter	Symbol	Min.	Typ.	Max.	Units	Test Conditions
	Luminous Intensity/Segment	I _V	0.8	2.00		mcd	I _F = 10 mA
				2.07		V	I _F = 10 mA
331G	Forward Voltage	V _F	1.80	2.25	2.60	V	I _F = 20 mA
333G	Peak Wavelength	λ _{PEAK}		568		nm	
334G	Dominant Wavelength	λ _d		573		nm	
	Reverse Voltage	VR	5			V	I _R = 100 μA

AlGaAs Red

Devices							
HDSP-	Parameter	Symbol	Min.	Typ.	Max.	Units	Test Conditions
331A 333A 334A	Luminous Intensity/Segment	I_V		3.93		mcd	$I_F = 5 \text{ mA}$
			2.001	4.20		mcd	$I_F = 10 \text{ mA}$
	Forward Voltage	V_F		1.85	2.00	V	$I_F = 20 \text{ mA}$
	Peak Wavelength	λ_{PEAK}		660		nm	
	Dominant Wavelength	λ_d		643		nm	
	Reverse Voltage	V_R	5			V	$I_R = 100 \mu\text{A}$

Yellow

Devices							
HDSP-	Parameter	Symbol	Min.	Typ.	Max.	Units	Test Conditions
331Y 333Y 334Y	Luminous Intensity/Segment	I_V		0.71		mcd	$I_F = 5 \text{ mA}$
			0.80	1.50		mcd	$I_F = 10 \text{ mA}$
	Forward Voltage	V_F		2.15	2.60	V	$I_F = 20 \text{ mA}$
	Peak Wavelength	λ_{PEAK}		595		nm	
	Dominant Wavelength	λ_d		590		nm	
	Reverse Voltage	V_R	5			V	$I_R = 100 \mu\text{A}$

Intensity Bin Limits (mcd at 10 mA)

Bin Name	HER/Green/Yellow		AlGaAs Red	
	Min. ^[1]	Max. ^[1]	Min. ^[1]	Max. ^[1]
G	0.801	1.250	NA	NA
H	1.251	2.000	NA	NA
I	2.001	3.200	2.001	3.200
J	NA	NA	3.201	5.050
K	NA	NA	5.051	8.000

Note:

1. Tolerance for each bin limit is $\pm 10\%$.

Color Bin Limits (nm at 10 mA)

Color	Bin	Dominant Wavelength (nm)	
		Min. ^[1]	Max. ^[1]
Green	3	569.1	571.0
	4	571.1	573.0
	5	573.1	575.0
Yellow	1	585.5	588.5
	2	588.5	591.5
	3	591.5	594.5

Note:

1. Tolerance for each bin limit is 1 nm.

High Efficiency Red (HER)

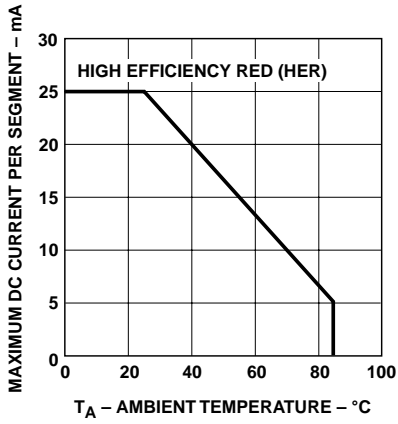

Figure 1. Maximum allowable average or DC current vs. ambient temperature.

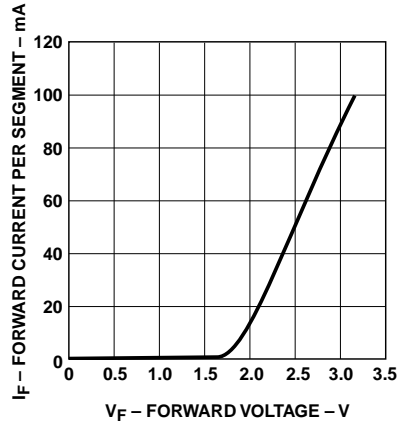

Figure 2. Forward current vs. forward voltage.

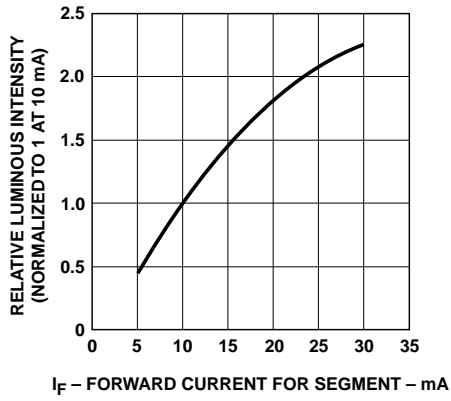

Figure 3. Relative luminous intensity vs. DC forward current.

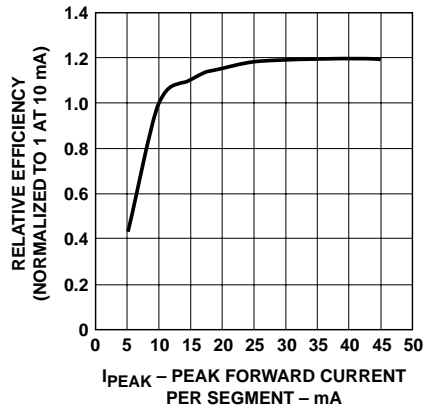

Figure 4. Relative efficiency (luminous intensity per unit current) vs. peak current.

Green

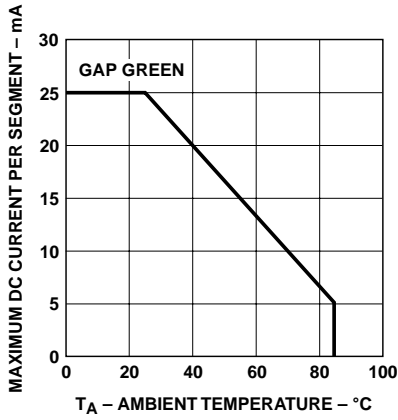

Figure 5. Maximum allowable average or DC current vs. ambient temperature.

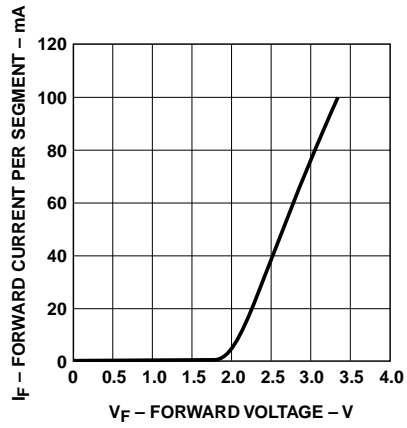

Figure 6. Forward current vs. forward voltage.

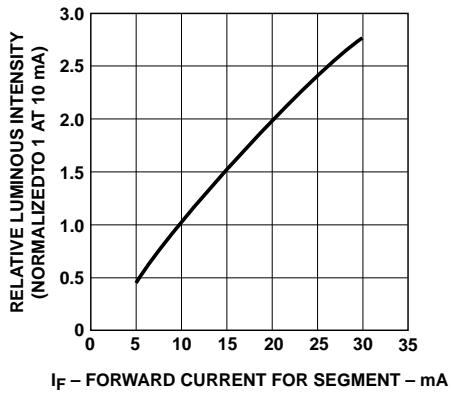

Figure 7. Relative luminous intensity vs. DC forward current.

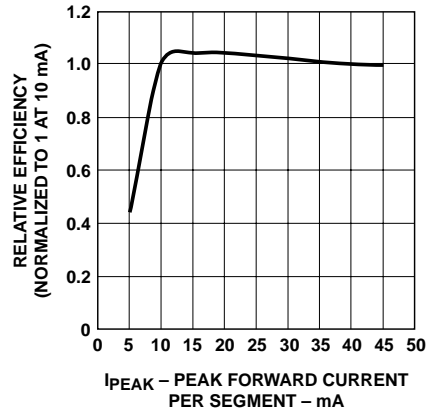

Figure 8. Relative efficiency (luminous intensity per unit current) vs. peak current.

AlGaAs Red

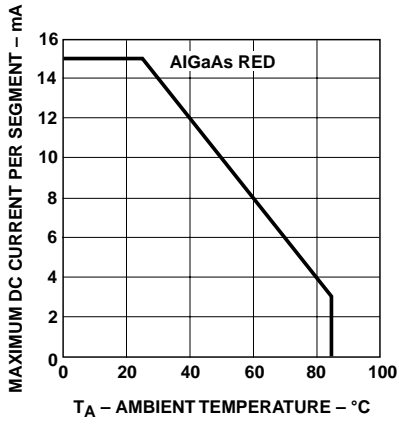

Figure 9. Maximum allowable average or DC current vs. ambient temperature.

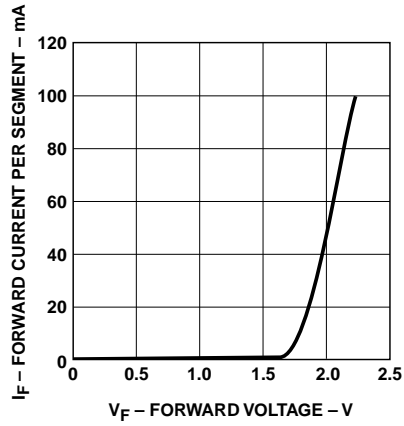

Figure 10. Forward current vs. forward voltage.

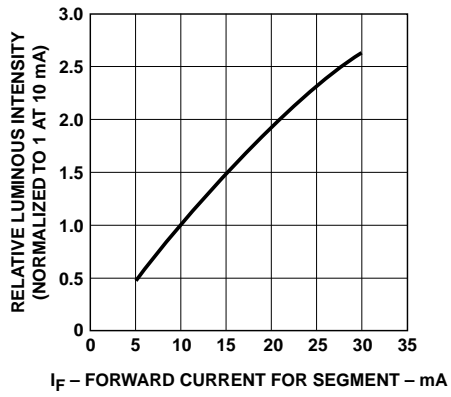

Figure 11. Relative luminous intensity vs. DC forward current.

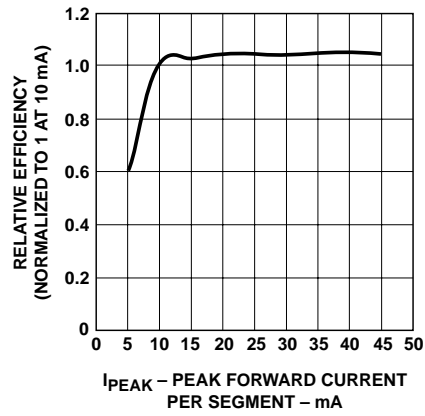

Figure 12. Relative efficiency (luminous intensity per unit current) vs. peak current.

Yellow

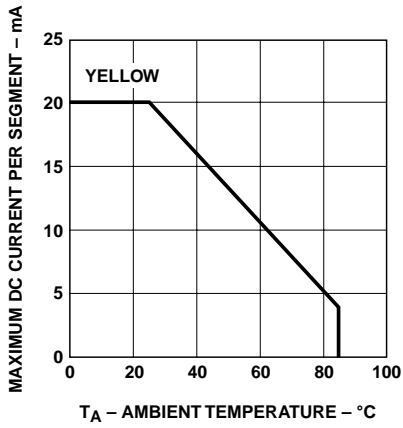

Figure 13. Maximum allowable average or DC current vs. ambient temperature.

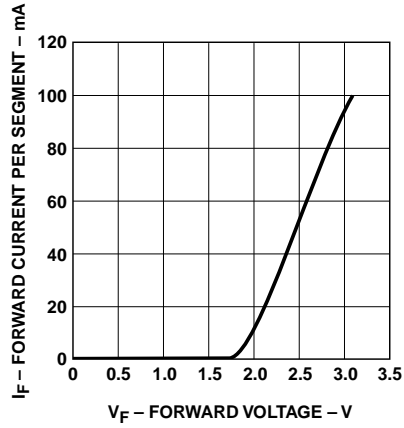

Figure 14. Forward current vs. forward voltage.

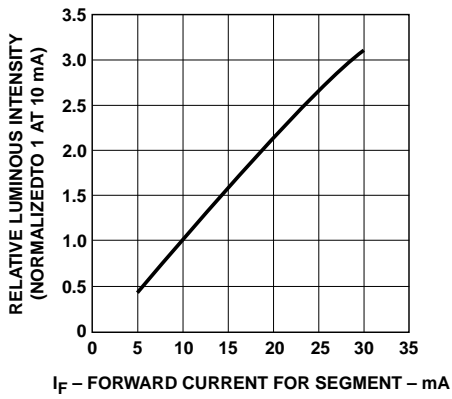

Figure 15. Relative luminous intensity vs. DC forward current.

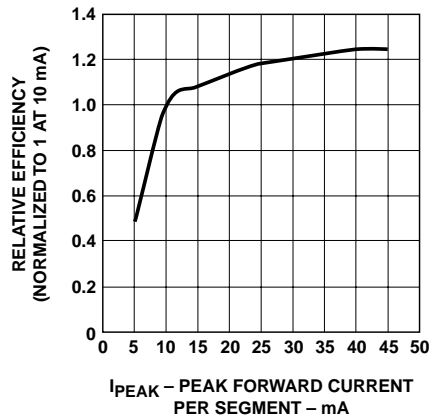

Figure 16. Relative efficiency (luminous intensity per unit current) vs. peak current.

www.agilent.com/semiconductors

For product information and a complete list of distributors, please go to our web site.

For technical assistance call:

Americas/Canada: +1 (800) 235-0312 or (916) 788-6763

Europe: +49 (0) 6441 92460

China: 10800 650 0017

Hong Kong: (+65) 6756 2394

India, Australia, New Zealand: (+65) 6755 1939

Japan: (+81 3) 3335-8152(Domestic/International), or 0120-61-1280(Domestic Only)

Korea: (+65) 6755 1989

Singapore, Malaysia, Vietnam, Thailand, Philippines, Indonesia: (+65) 6755 2044

Taiwan: (+65) 6755 1843

Data subject to change.

Obsoletes 5988-2971EN

July 17, 2004

5988-9421EN



Agilent Technologies

Данный компонент на территории Российской Федерации

Вы можете приобрести в компании MosChip.

Для оперативного оформления запроса Вам необходимо перейти по данной ссылке:

<http://moschip.ru/get-element>

Вы можете разместить у нас заказ для любого Вашего проекта, будь то серийное производство или разработка единичного прибора.

В нашем ассортименте представлены ведущие мировые производители активных и пассивных электронных компонентов.

Распределительные склады, находящиеся в России, Европе и в Китае, позволяют нам оперативно поставить необходимые компоненты в оптимальные для Вас сроки.

На всех этапах разработки и производства наши партнеры могут получить квалифицированную поддержку опытных инженеров.

Система менеджмента качества компании отвечает требованиям ISO 9001:2011

Офис по работе с юридическими лицами:

107023, г.Москва, Семеновский переулок, д.6, Бизнес-центр «АВС»

Телефон: +7 495 668-12-70 (многоканальный)

Факс: +7 495 668-12-70 (доб.304)

E-mail: info@moschip.ru

Skype отдела продаж:

moschip.ru_3	moschip.ru_6
moschip.ru_4	moschip.ru_7
moschip.ru_11	moschip.ru_8
moschip.ru_12	moschip.ru_9