

SLLIMM™ nano - 2nd series IPM, 3-phase inverter, 5 A, 600 V, short-circuit rugged IGBTs

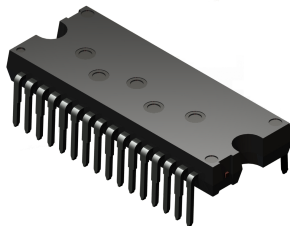

N2DIP-26L type L

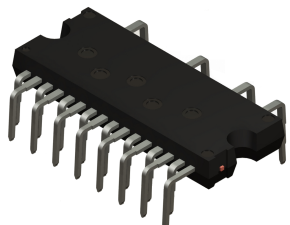

N2DIP-26L type Z

Features

- IPM 5 A, 600 V, 3-phase IGBT inverter bridge including 3 control ICs for gate driving and freewheeling diodes
- 3.3 V, 5 V, 15 V TTL/CMOS input comparators with hysteresis and pull-down/pull-up resistors
- Internal bootstrap diode
- Optimized for low electromagnetic interference
- Undervoltage lockout
- Short-circuit rugged TFS IGBTs
- Shutdown function
- Interlocking function
- Op-amp for advanced current sensing
- Comparator for fault protection against overcurrent
- NTC (UL 1434 CA 2 and 4)
- Isolation ratings of 1500 Vrms/min.
- Up to ±2 kV ESD protection (HBM C = 100 pF, R = 1.5 kΩ)
- UL recognition: UL 1557, file E81734

Applications

- 3-phase inverters for motor drives
- Dish washers, refrigerator compressors, heating systems, air-conditioning fans, draining and recirculation pumps



Description

This second series of SLLIMM (small low-loss intelligent molded module)-nano provides a compact, high-performance AC motor drive in a simple, rugged design. It is composed of six improved short-circuit rugged trench gate fieldstop IGBTs with freewheeling diodes and three half-bridge HVICs for gate driving, providing low electromagnetic interference (EMI) characteristics with optimized switching speed. The package is designed to allow a better and more easily screwed-on heatsink, and is optimized for thermal performance and compactness in built-in motor applications or other low power applications where assembly space is limited. This IPM includes a completely uncommitted operational amplifier and a comparator that can be used to design a fast and efficient protection circuit. SLLIMM™ is a trademark of STMicroelectronics.

Product status link	
	STGIPQ5C60T-HL
	STGIPQ5C60T-HZ
Product summary	
STGIPQ5C60T-HL	
Order code	STGIPQ5C60T-HL
Marking	GIPQ5C60T-HL
Package	N2DIP-26L type L
Packing	Tube
STGIPQ5C60T-HZ	
Order code	STGIPQ5C60T-HZ
Marking	GIPQ5C60T-HZ
Package	N2DIP-26L type Z
Packing	Tube

1 Internal schematic diagram and pin configuration

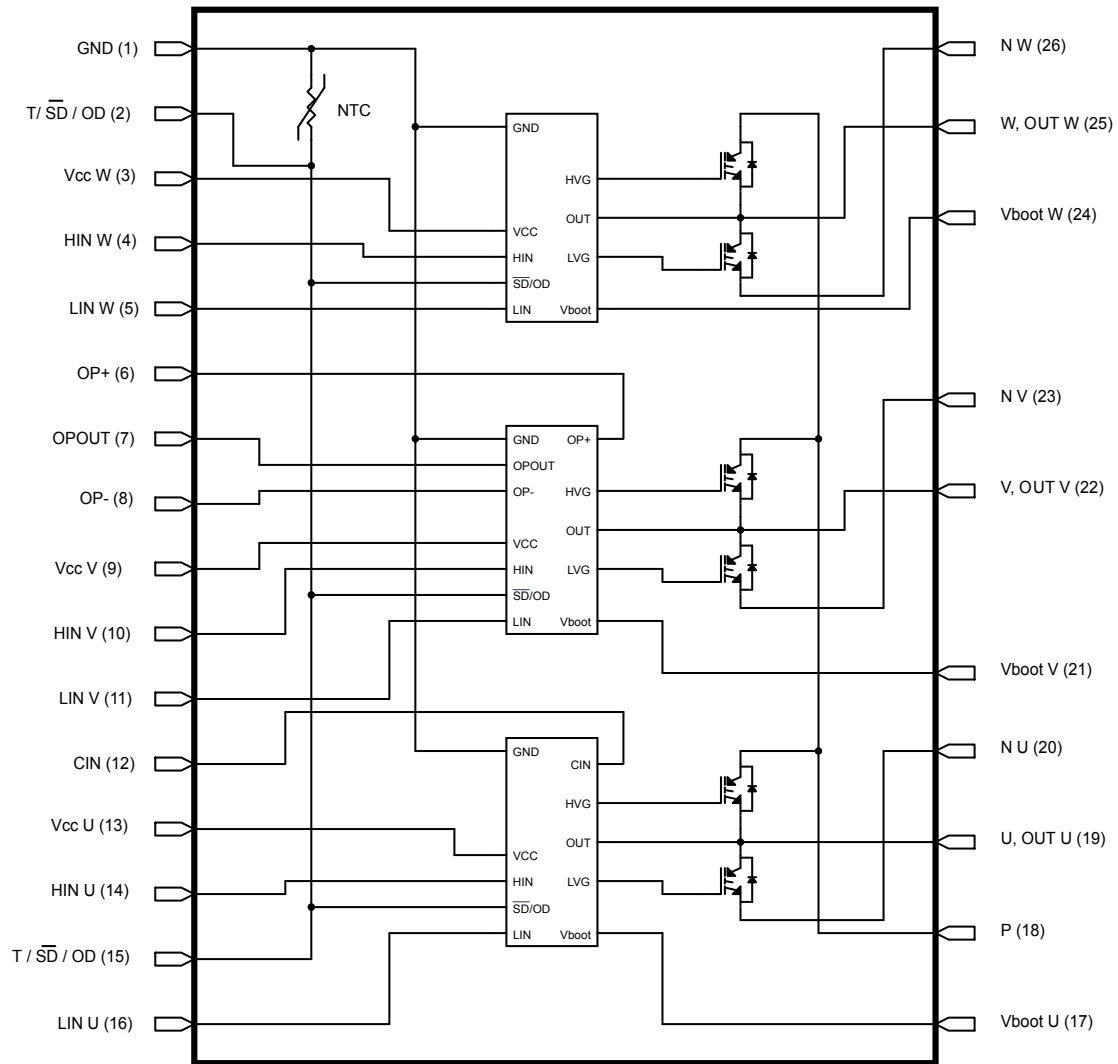
Figure 1. Internal schematic diagram

GIPG300720141542SMD

Table 1. Pin description

Pin	Symbol	Description
1	GND	Ground
2	T/ $\overline{\text{SD}}$ / OD	NTC thermistor terminal/shutdown logic input (active low)/open-drain (comparator output)
3	V _{CC} W	Low-voltage power supply W phase
4	HIN W	High-side logic input for W phase
5	LIN W	Low-side logic input for W phase
6	OP+	Op-amp non-inverting input
7	OP _{OUT}	Op-amp output
8	OP-	Op-amp inverting input
9	V _{CC} V	Low-voltage power supply V phase
10	HIN V	High-side logic input for V phase
11	LIN V	Low-side logic input for V phase
12	CIN	Comparator input
13	V _{CC} U	Low-voltage power supply for V phase
14	HIN U	High-side logic input for V phase
15	T/ $\overline{\text{SD}}$ / OD	NTC thermistor terminal/shutdown logic input (active low)/open-drain (comparator output)
16	LIN U	Low-side logic input for U phase
17	V _{boot} U	Bootstrap voltage for U phase
18	P	Positive DC input
19	U, OUT _U	U phase output
20	N _U	Negative DC input for U phase
21	V _{boot} V	Bootstrap voltage for V phase
22	V, OUT _V	V phase output
23	N _V	Negative DC input for V phase
24	V _{boot} W	Bootstrap voltage for W phase
25	W, OUT _W	W phase output
26	N _W	Negative DC input for W phase

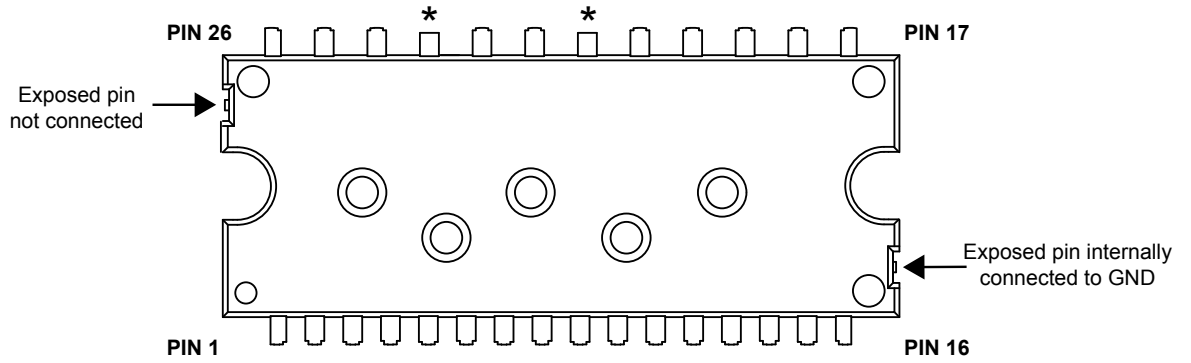
Figure 2. Pin layout (top view) - N2DIP-26L type L

* Dummy pins internally connected to P (positive DC input)

GADG181220181209IG

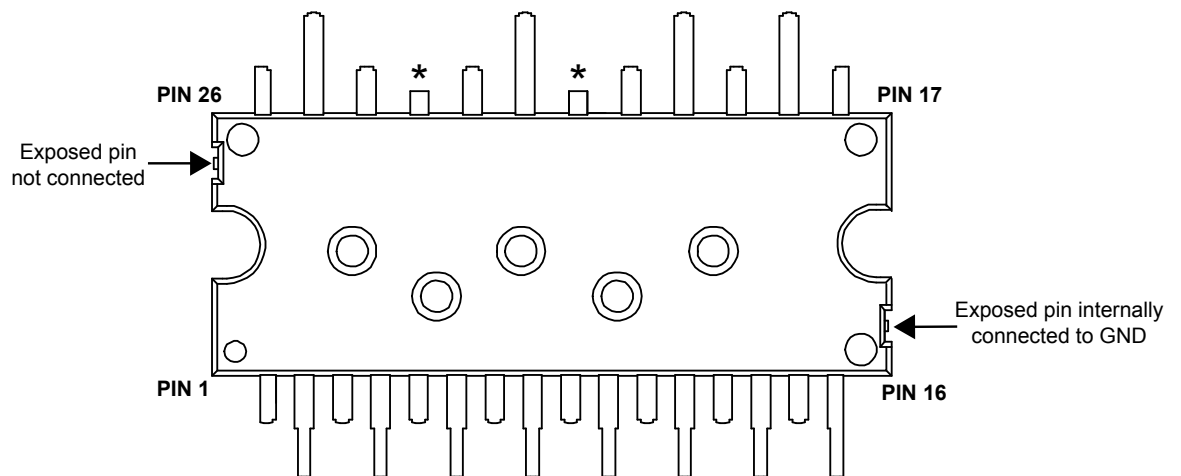
Figure 3. Pin layout (top view) - N2DIP-26L type Z

* Dummy pins internally connected to P (positive DC input)

GADG181220181216IG

2 Electrical ratings

$T_J = 25\text{ °C}$ unless otherwise specified

2.1 Absolute maximum ratings

Table 2. Inverter part

Symbol	Parameter	Value	Unit
V_{CES}	Collector-emitter voltage for each IGBT ($V_{IN}^{(1)} = 0$)	600	V
I_C	Continuous collector current for each IGBT ($T_C = 25\text{ °C}$)	5	A
$I_{CP}^{(2)}$	Peak collector current for each IGBT (less than 1 ms)	10	A
P_{TOT}	Total power dissipation for each IGBT ($T_C = 25\text{ °C}$)	13.6	W

1. Applied among HIN_x , LIN_x and GND for $x = U, V, W$
2. Pulse width limited by max. junction temperature.

Table 3. Control part

Symbol	Parameter	Min.	Max.	Unit
V_{CC}	Low voltage power supply	-0.3	21	V
V_{boot}	Bootstrap voltage	-0.3	620	V
V_{OUT}	Output voltage applied among OUT_U , OUT_V , OUT_W - GND	$V_{boot} - 21$	$V_{boot} + 0.3$	V
V_{CIN}	Comparator input voltage	-0.3	$V_{CC} + 0.3$	V
V_{op+}	Op-amp non-inverting input	-0.3	$V_{CC} + 0.3$	V
V_{op-}	Op-amp inverting input	-0.3	$V_{CC} + 0.3$	V
V_{IN}	Logic input voltage applied among HIN_x , LIN_x and GND	-0.3	15	V
$V_{T/SD/OD}$	Open-drain voltage	-0.3	15	V
dV_{out}/dt	Allowed output slew rate		50	V/ns

Table 4. Total system

Symbol	Parameter	Value	Unit
V_{ISO}	Isolation withstand voltage applied between each pin and heatsink plate (AC voltage, $t = 60\text{ s}$)	1500	Vrms
T_J	Power chip operating junction temperature	-40 to 150	°C
T_C	Module case operation temperature	-40 to 125	°C

2.2 Thermal data

Table 5. Thermal data

Symbol	Parameter	Value	Unit
$R_{th(j-c)}$	Thermal resistance junction-case single IGBT	9.2	°C/W
	Thermal resistance junction-case single diode	15	

3 Electrical characteristics

$T_J = 25\text{ °C}$ unless otherwise noted.

3.1 Inverter part

Table 6. Static

Symbol	Parameter	Test conditions	Min.	Typ.	Max.	Unit
I_{CES}	Collector cut-off current ($V_{IN} = 0$ "logic state")	$V_{CE} = 550\text{ V}$, $V_{CC} = V_{Boot} = 15\text{ V}$	-		250	μA
$V_{CE(sat)}$	Collector-emitter saturation voltage	$V_{CC} = V_{boot} = 15\text{ V}$, $V_{IN}^{(1)} = 0$ to 5 V , $I_C = 5\text{ A}$	-	1.7	2.15	V
V_F	Diode forward voltage	$V_{IN} = 0$ "logic state", $I_C = 5\text{ A}$	-	2.1		V

1. Applied among HIN_x , LIN_x and G_{ND} for $x = U, V, W$

Table 7. Inductive load switching time and energy

Symbol	Parameter	Test conditions	Min.	Typ.	Max.	Unit
$t_{on}^{(1)}$	Turn-on time	$V_{DD} = 300\text{ V}$, $V_{CC} = V_{boot} = 15\text{ V}$, $V_{IN}^{(2)} = 0$ to 5 V , $I_C = 5\text{ A}$ (see Figure 5. Switching time definition)	-	280	-	ns
$t_{c(on)}^{(1)}$	Crossover time (on)		-	130	-	
$t_{off}^{(1)}$	Turn-off time		-	950	-	
$t_{c(off)}^{(1)}$	Crossover time (off)		-	115	-	
t_{rr}	Reverse recovery time		-	94	-	
E_{on}	Turn-on switching energy		-	110	-	μJ
E_{off}	Turn-off switching energy		-	93	-	

1. t_{ON} and t_{OFF} include the propagation delay times of the internal drive. $t_{C(ON)}$ and $t_{C(OFF)}$ are the switching times of IGBT itself under the internally given gate driving conditions.

2. Applied among HIN_x , LIN_x and G_{ND} for $x = U, V, W$.

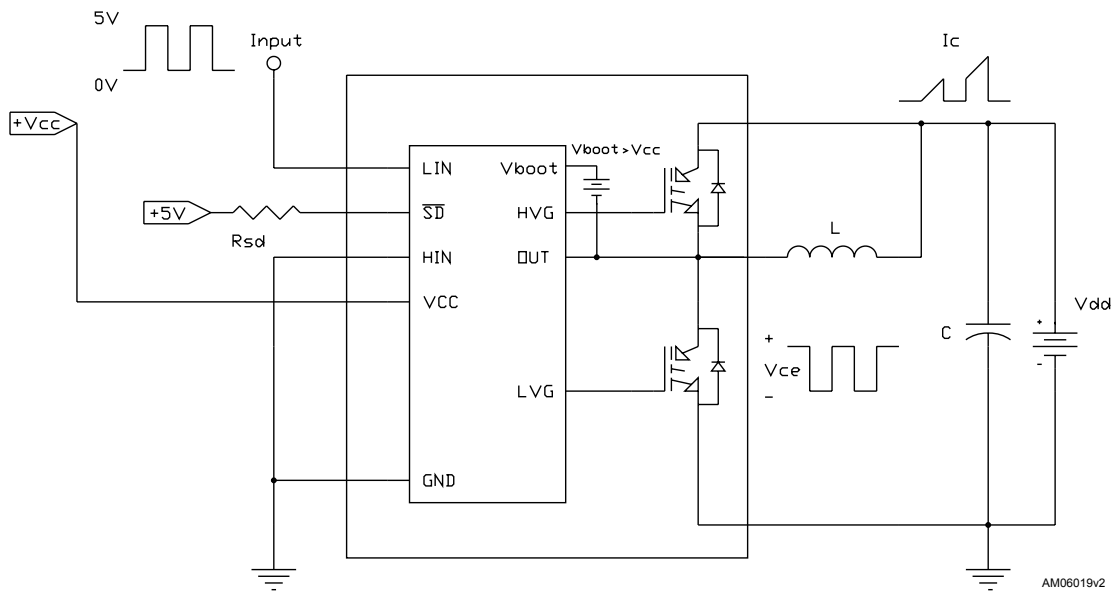
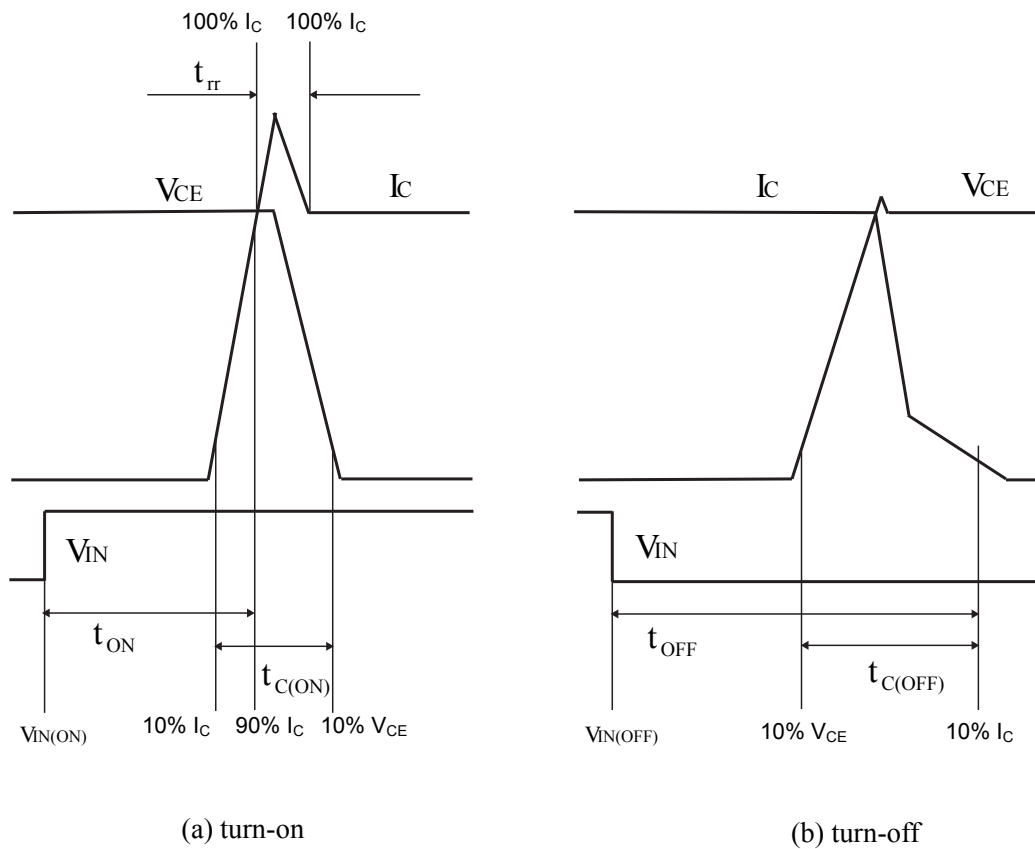
Figure 4. Switching time test circuit

Figure 5. Switching time definition

AM09223V1

Figure 5. Switching time definition refers to HIN, LIN inputs (active high).

3.2 Control part

Table 8. Low-voltage power supply

Symbol	Parameter	Test conditions	Min.	Typ.	Max.	Unit
V_{CC_hys}	V_{CC} UV hysteresis		1.2	1.5	1.8	V
V_{CC_thON}	V_{CC} UV turn-ON threshold		11.5	12	12.5	V
V_{CC_thOFF}	V_{CC} UV turn-OFF threshold		10	10.5	11	V
I_{qccu}	Undervoltage quiescent supply current	$V_{CC} = 10\text{ V}$, $T/\overline{SD}/OD = 5\text{ V}$, $LIN = HIN = CIN = 0\text{ V}$			150	μA
I_{qcc}	Quiescent current	$V_{CC} = 10\text{ V}$, $T/\overline{SD}/OD = 5\text{ V}$, $LIN = HIN = CIN = 0\text{ V}$			1	mA
V_{ref}	Internal comparator (CIN) reference voltage		0.51	0.54	0.56	V

Table 9. Bootstrapped voltage

Symbol	Parameter	Test conditions	Min.	Typ.	Max.	Unit
V_{BS_hys}	V_{BS} UV hysteresis		1.2	1.5	1.8	V
V_{BS_thON}	V_{BS} UV turn-ON threshold		11.1	11.5	12.1	V
V_{BS_thOFF}	V_{BS} UV turn-OFF threshold		9.8	10	10.6	V
I_{QBSU}	Undervoltage V_{BS} quiescent current	$V_{BS} < 9\text{ V}$, $T/\overline{SD}/OD = 5\text{ V}$, $LIN = 0\text{ V}$ and $HIN = 5\text{ V}$, $CIN = 0\text{ V}$		70	110	μA
I_{QBS}	V_{BS} quiescent current	$V_{BS} = 15\text{ V}$, $T/\overline{SD}/OD = 5\text{ V}$, $LIN = 0\text{ V}$ and $HIN = 5\text{ V}$, $CIN = 0$		150	210	μA
$R_{DS(on)}$	Bootstrap driver on-resistance	LVG ON		120		Ω

Table 10. Logic inputs

Symbol	Parameter	Test conditions	Min.	Typ.	Max.	Unit
V_{il}	Low logic level voltage				0.8	V
V_{ih}	High logic level voltage		2.25			V
I_{HINh}	HIN logic "1" input bias current	$HIN = 15\text{ V}$	20	40	100	μA
I_{HINl}	HIN logic "0" input bias current	$HIN = 0\text{ V}$			1	μA
I_{LINl}	LIN logic "0" input bias current	$LIN = 0\text{ V}$			1	μA
I_{LINh}	LIN logic "1" input bias current	$LIN = 15\text{ V}$	20	40	100	μA
I_{SDh}	\overline{SD} logic "0" input bias current	$\overline{SD} = 15\text{ V}$	210	350	477	μA
I_{SDl}	\overline{SD} logic "1" input bias current	$\overline{SD} = 0\text{ V}$			3	μA
Dt	Dead time	See Figure 10. Dead time and interlocking waveform definitions		180		ns

Table 11. Op-amp characteristics

Symbol	Parameter	Test conditions	Min.	Typ.	Max.	Unit
V_{io}	Input offset voltage	$V_{ic} = 0\text{ V}, V_o = 7.5\text{ V}$			6	mV
I_{io}	Input offset current	$V_{ic} = 0\text{ V}, V_o = 7.5\text{ V}$		4	40	nA
I_{ib}	Input bias current ⁽¹⁾			100	200	nA
V_{OL}	Low level output voltage	$R_L = 10\text{ k}\Omega$ to V_{CC}		75	150	mV
V_{OH}	High level output voltage	$R_L = 10\text{ k}\Omega$ to GND	14	14.7		V
I_o	Output short-circuit current	Source, $V_{id} = +1\text{ V}; V_o = 0\text{ V}$	16	30		mA
		Sink, $V_{id} = -1\text{ V}; V_o = V_{CC}$	50	80		mA
SR	Slew rate	$V_i = 1 - 4\text{ V}; C_L = 100\text{ pF};$ unity gain	2.5	3.8		V/ μ s
GBWP	Gain bandwidth product	$V_o = 7.5\text{ V}$	8	12		MHz
A_{vd}	Large signal voltage gain	$R_L = 2\text{ k}\Omega$	70	85		dB
SVR	Supply voltage rejection ratio	vs V_{CC}	60	75		dB
CMRR	Common mode rejection ratio		55	70		dB

1. The direction of input current is out of the IC.

Table 12. Sense comparator characteristics

Symbol	Parameter	Test conditions	Min.	Typ.	Max.	Unit
I_{ib}	Input bias current	$V_{CIN} = 1\text{ V}$	-		1	μ A
V_{od}	Open-drain low level output voltage	$I_{od} = 3\text{ mA}$	-		0.5	V
R_{ON_OD}	Open-drain low level output	$I_{od} = 3\text{ mA}$	-	166		Ω
R_{PD_SD}	\overline{SD} pull-down resistor ⁽¹⁾		-	125		k Ω
t_{d_comp}	Comparator delay	T/ \overline{SD} /OD pulled to 5 V through 100 k Ω resistor	-	90	130	ns
SR	Slew rate	$C_L = 180\text{ pF}, R_{pu} = 5\text{ k}\Omega$	-	60		V/ μ s
t_{sd}	Shutdown to high-/low-side driver propagation delay	$V_{OUT} = 0, V_{boot} = V_{CC}, V_{IN} = 0$ to 3.3 V	-	125		ns
t_{isd}	Comparator triggering to high-/low-side driver turn-off propagation delay	Measured applying a voltage step from 0 V to 3.3 V to pin CIN	-	200		

1. Equivalent values as a result of the resistances of three drivers in parallel.

Table 13. Truth table

Conditions	Logic input (V _I)			Output	
	T/ $\overline{\text{SD}}$ /OD	LIN	HIN	LVG	HVG
Shutdown enable half-bridge tri-state	L	X ⁽¹⁾	X ⁽¹⁾	L	L
Interlocking half-bridge tri-state	H	H	H	L	L
0 "logic state" half-bridge tri-state	H	L	L	L	L
1 "logic state" low-side direct driving	H	H	L	H	L
1 "logic state" high-side direct driving	H	L	H	L	H

1. X: don't care.

3.2.1 NTC thermistor

Figure 6. Internal structure of \overline{SD} and NTC

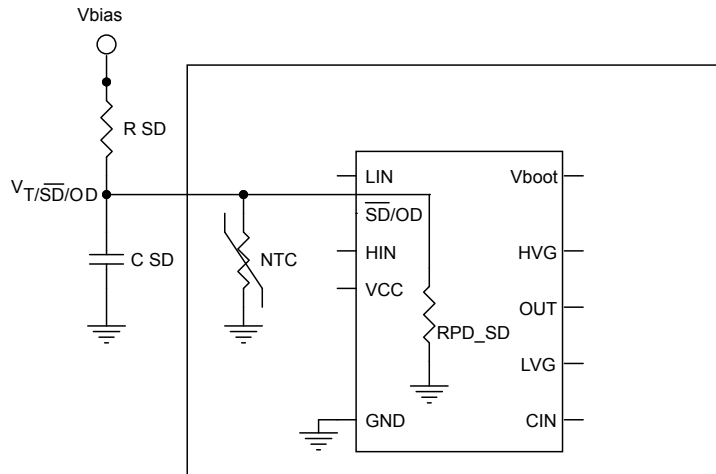

RPD_SD: equivalent value as result of resistances of three drivers in parallel.

Figure 7. Equivalent resistance (NTC//R_{PD_SD})

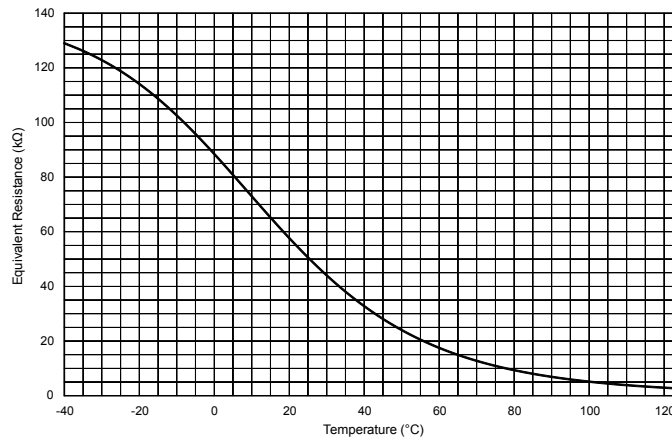

Figure 8. Equivalent resistance (NTC//R_{PD_SD}) zoom

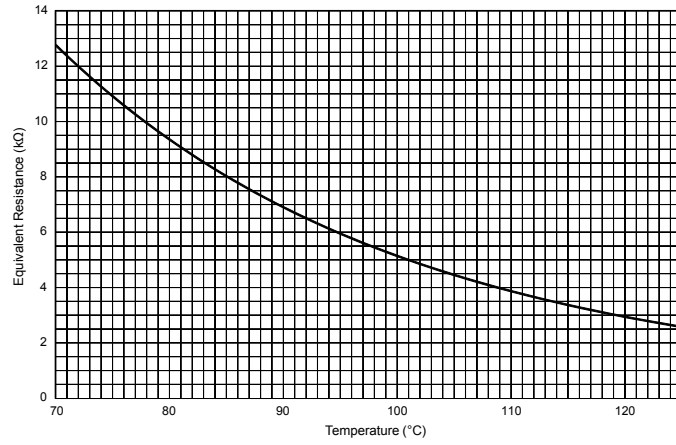
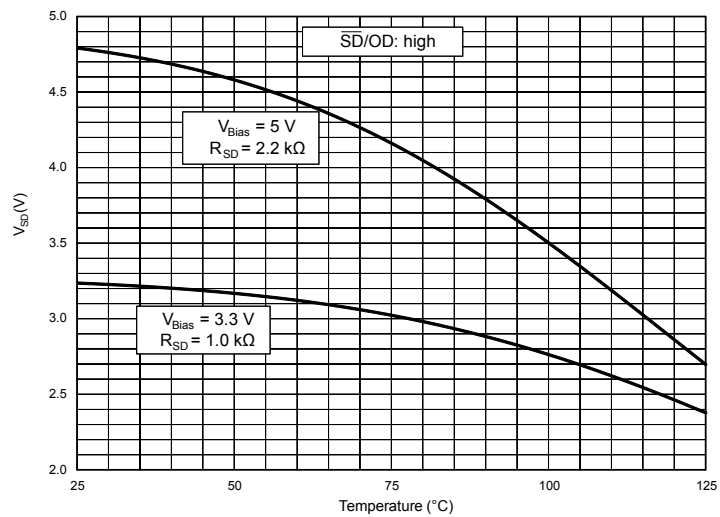
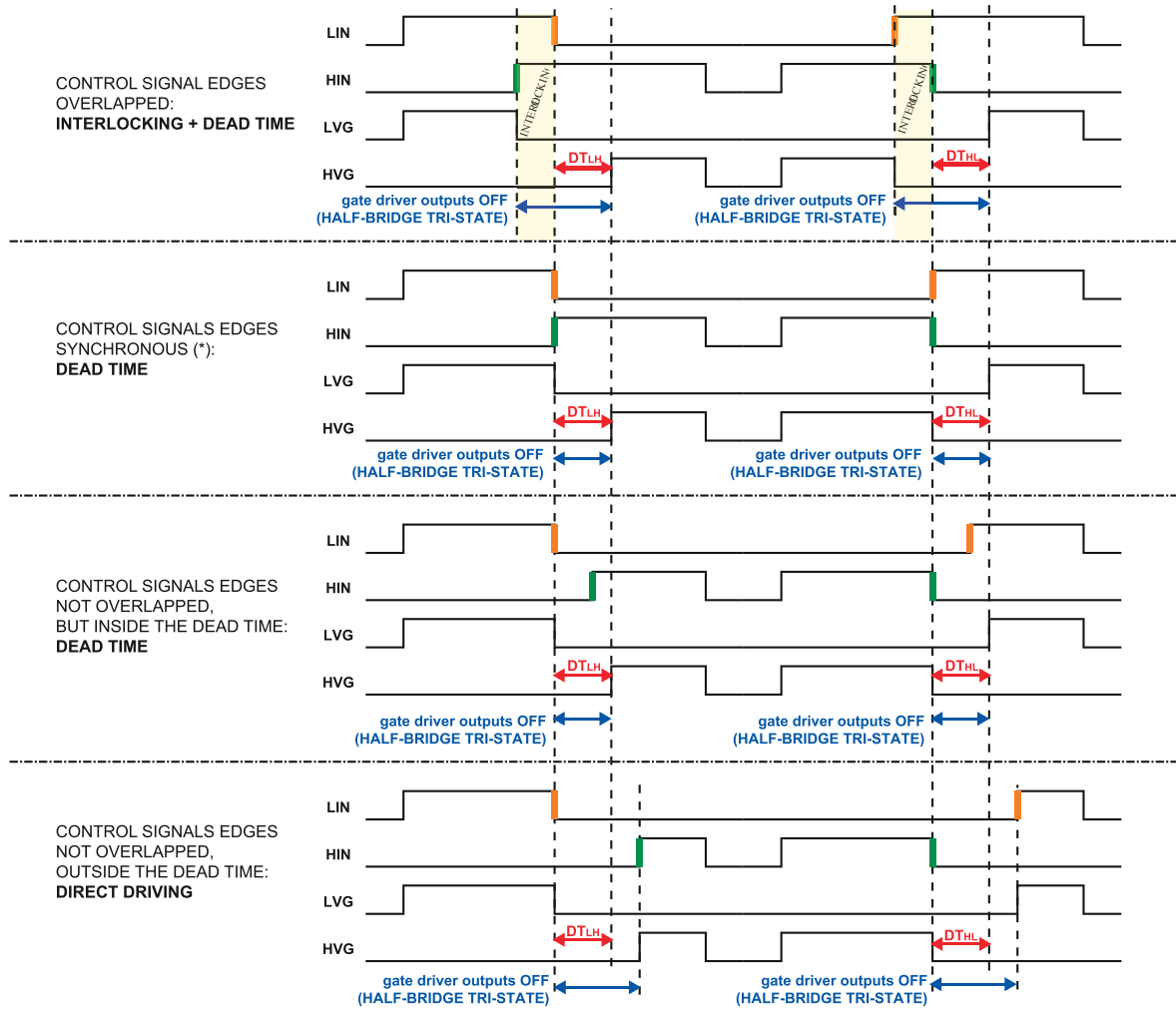

Figure 9. Voltage of T/SD/OD pin according to NTC temperature



3.3 Waveform definitions

Figure 10. Dead time and interlocking waveform definitions

4 Shutdown function

The device is equipped with three half-bridge IC gate drivers and integrates a comparator for fault detection. The comparator has an internal voltage reference V_{REF} connected to the inverting input, while the non-inverting input pin (CIN) can be connected to an external shunt resistor for current monitoring.

Since the comparator is embedded in the U IC gate driver, in case of fault it disables directly the U outputs, whereas the shutdown of V and W IC gate drivers depends on the RC value of the external SD circuitry, which fixes the disabling time.

For an effective design of the shutdown circuit, please refer to Application note AN4966.

Figure 11. Shutdown timing waveforms

GADG250120171515FSR

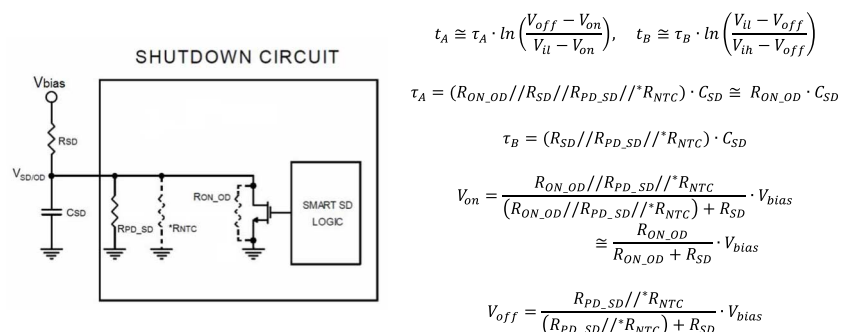
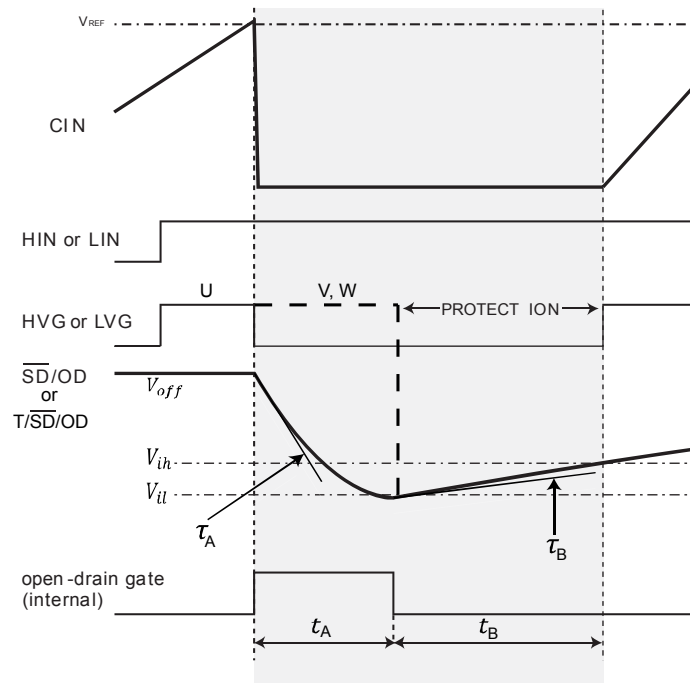

R_{SD} and C_{SD} external circuitry must be designed to ensure $V_{on} < V_{il}$ & $V_{off} > V_{ih}$

Please refer to AN4966 for further details.

* R_{NTC} to be considered only when the NTC is internally connected to the T/SD/OD pin.

5.1 Guidelines

- Input signals HIN, LIN are active high logic. A 375 kΩ (typ.) pull-down resistor is built-in for each input. To avoid input signal oscillation, the wiring of each input should be as short as possible, and the use of RC filters (R_1 , C_1) on each input signal is suggested. The filters should be with a time constant of about 100 ns and placed as close as possible to the IPM input pins.
- The use of a bypass capacitor C_{VCC} (aluminum or tantalum) can reduce the transient circuit demand on the power supply. Also, to reduce any high-frequency switching noise distributed on the power lines, a decoupling capacitor C_2 (100 to 220 nF, with low ESR and low ESL) should be placed as close as possible to the V_{CC} pin and in parallel with the bypass capacitor.
- The use of an RC filter (R_{SF} , C_{SF}) is recommended to prevent protection circuit malfunction. The time constant ($R_{SF} \times C_{SF}$) should be set to 1 μs and the filter must be placed as close as possible to the C_{IN} pin.
- The \overline{SD} is an input/output pin (open-drain type if it is used as output). A built-in thermistor NTC is internally connected between the \overline{SD} pin and GND. The voltage V_{SD-GND} decreases as the temperature increases, due to the pull-up resistor R_{SD} . In order to keep the voltage always higher than the high-level logic threshold, the pull-up resistor should be set to 1 kΩ or 2.2 kΩ for 3.3 V or 5 V MCU power supply, respectively. The capacitor C_{SD} of the filter on \overline{SD} should be fixed no higher than 3.3 nF in order to assure the \overline{SD} activation time $\tau_A \leq 500$ ns. Besides, the filter should be placed as close as possible to the \overline{SD} pin.
- The decoupling capacitor C_3 (from 100 to 220 nF, ceramic with low ESR and low ESL), in parallel with each C_{boot} , filters high-frequency disturbance. Both C_{boot} and C_3 (if present) should be placed as close as possible to the U, V, W and V_{boot} pins. Bootstrap negative electrodes should be connected to U, V, W terminals directly and separated from the main output wires.
- To avoid overvoltage on the V_{CC} pin, a Zener diode (Dz1) can be used. Similarly on the V_{boot} pin, a Zener diode (Dz2) can be placed in parallel with each C_{boot} .
- The use of the decoupling capacitor C_4 (100 to 220 nF, with low ESR and low ESL) in parallel with the electrolytic capacitor C_{vdc} is useful to prevent surge destruction. Both capacitors C_4 and C_{vdc} should be placed as close as possible to the IPM (C_4 has priority over C_{vdc}).
- By integrating an application-specific type HVIC inside the module, direct coupling to the MCU terminals without an opto-couplers is possible.
- Low-inductance shunt resistors have to be used for phase leg current sensing.
- In order to avoid malfunctions, the wiring on N pins, the shunt resistor and P_{WR_GND} should be as short as possible.
- The connection of SGN_GND to PWR_GND on one point only (close to the shunt resistor terminal) can reduce the impact of power ground fluctuation.

These guidelines ensure the specifications of the device for application designs. For further details, please refer to the relevant application note.

Table 14. Recommended operating conditions

Symbol	Parameter	Test conditions	Min.	Typ.	Max.	Unit
V_{PN}	Supply voltage	Applied among P-Nu, Nv, Nw		300	500	V
V_{CC}	Control supply voltage	Applied to V_{CC-GND}	13.5	15	18	V
V_{BS}	High-side bias voltage	Applied to $V_{BOOTx-OUT}$ for $x = U, V, W$	13		18	V
t_{dead}	Blanking time to prevent arm-short	For each input signal	1.5			μs
f_{PWM}	PWM input signal	-40 °C < T_C < 100 °C -40 °C < T_J < 125 °C			25	kHz
T_C	Case operation temperature				100	°C

6 Electrical characteristics (curves)

Figure 13. Output characteristics

Figure 14. $V_{ce(sat)}$ vs collector current

Figure 15. I_c vs case temperature

Figure 16. Diode V_F vs forward current

Figure 17. E_{on} switching energy vs collector current

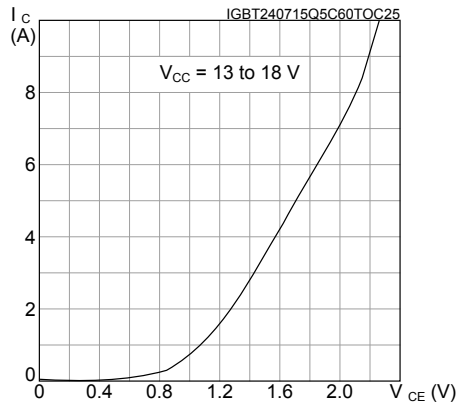
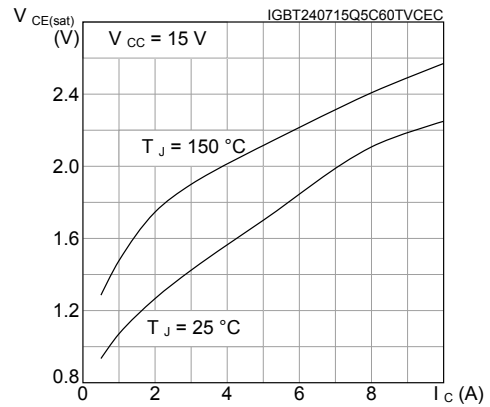
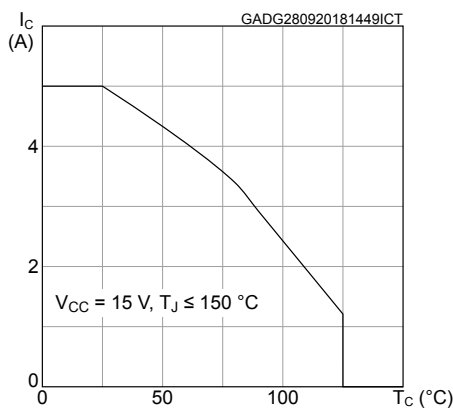
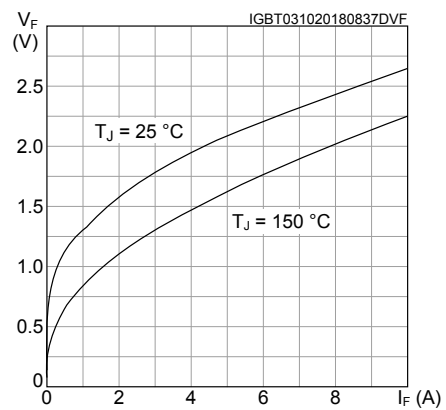
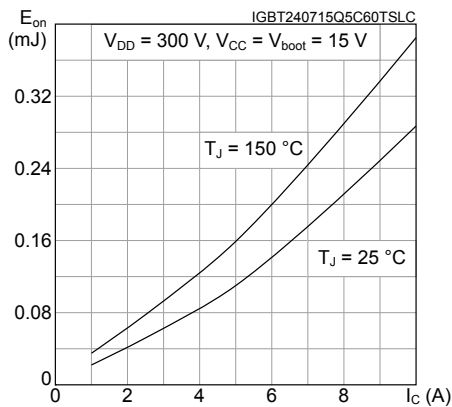
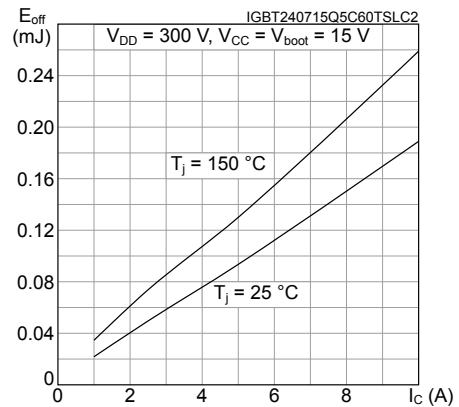
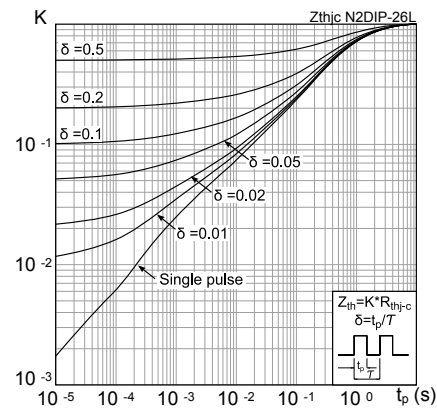
Figure 18. E_{off} switching energy vs collector current

Figure 19. Thermal impedance for IGBT

7 Package information

In order to meet environmental requirements, ST offers these devices in different grades of **ECOPACK®** packages, depending on their level of environmental compliance. ECOPACK® specifications, grade definitions and product status are available at: www.st.com. ECOPACK® is an ST trademark.

7.1 N2DIP-26L type L package information

Figure 20. N2DIP-26L type L package outline

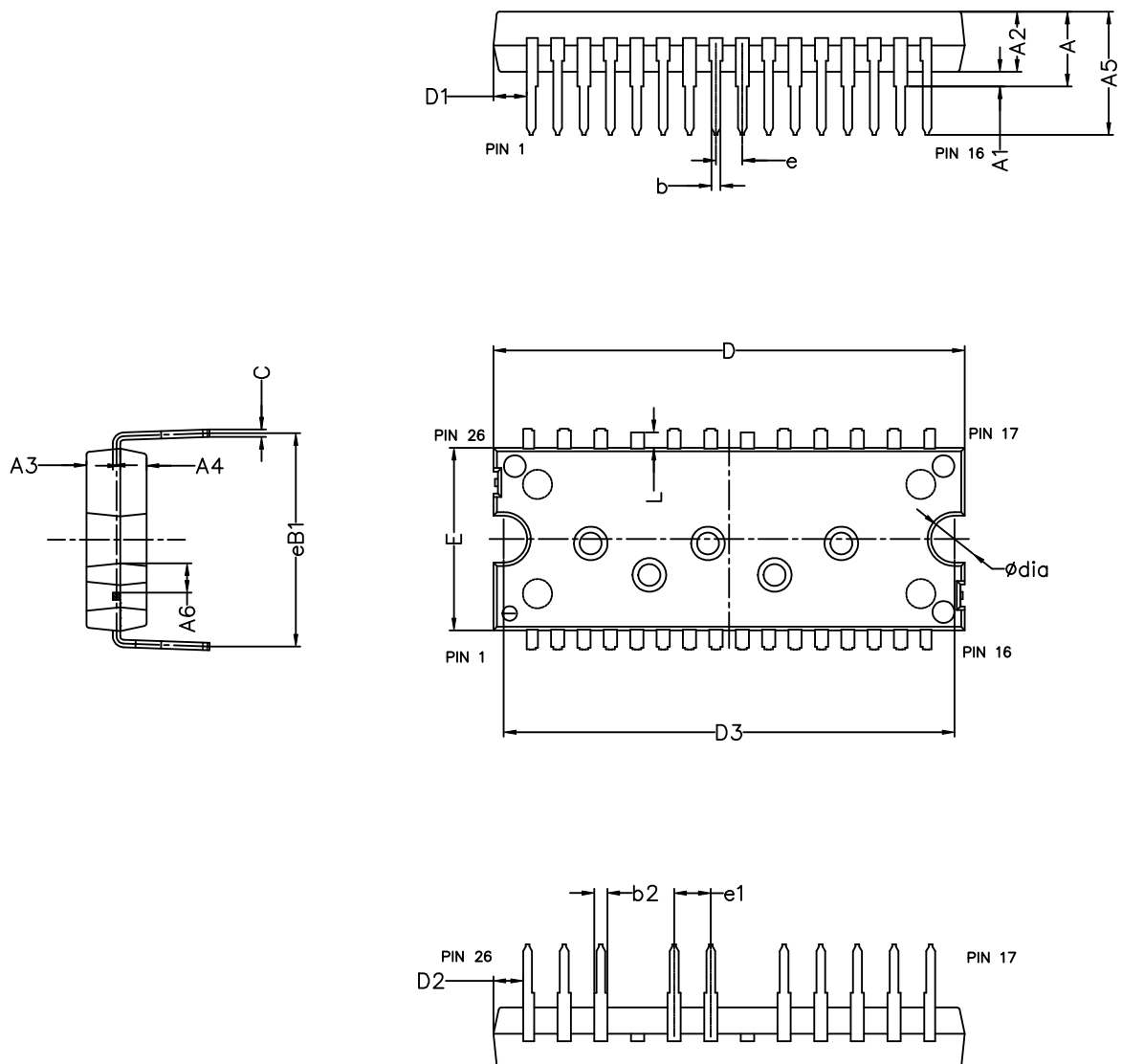

8558322_typeL_rev3

Table 15. N2DIP-26L type L mechanical data

Dim.	mm		
	Min.	Typ.	Max.
A	4.80	5.10	5.40
A1	0.80	1.00	1.20
A2	4.00	4.10	4.20
A3	1.70	1.80	1.90
A4	1.70	1.80	1.90
A5	8.10	8.40	8.70
A6	1.75		
b	0.53		0.72
b2	0.83		1.02
c	0.46		0.59
D	32.05	32.15	32.25
D1	2.10		
D2	1.85		
D3	30.65	30.75	30.85
E	12.35	12.45	12.55
e	1.70	1.80	1.90
e1	2.40	2.50	2.60
eB1	14.25	14.55	14.85
L	0.85	1.05	1.25
Dia	3.10	3.20	3.30

7.2 N2DIP-26L type Z package information

Figure 21. N2DIP-26L type Z package outline

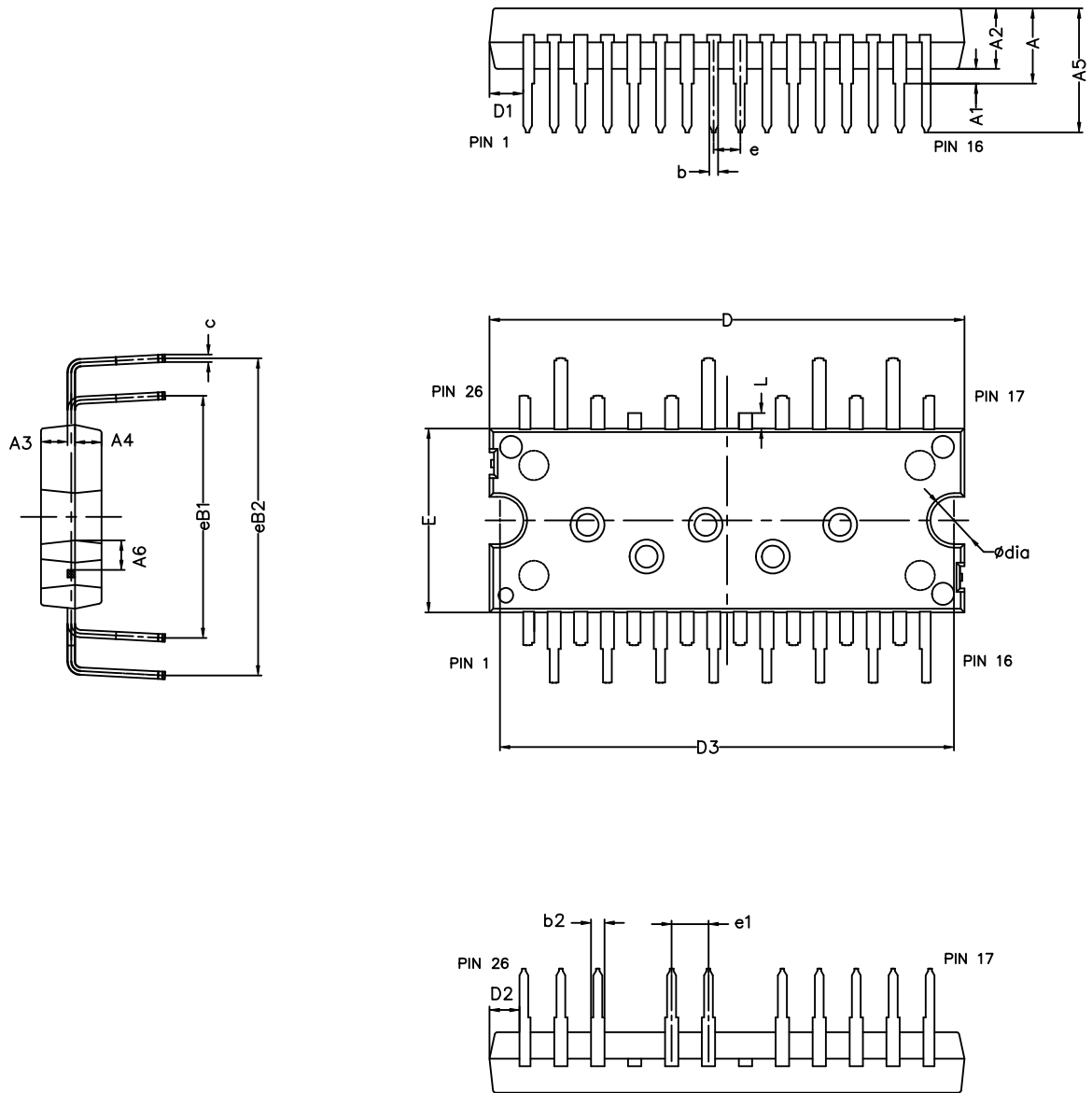

8558322_typeZ_rev3

Table 16. N2DIP-26L type Z mechanical data

Dim.	mm		
	Min.	Typ.	Max.
A	4.80	5.10	5.40
A1	0.80	1.00	1.20
A2	4.00	4.10	4.20
A3	1.70	1.80	1.90
A4	1.70	1.80	1.90
A5	8.10	8.40	8.70
A6	1.75		
b	0.53		0.72
b2	0.83		1.02
c	0.46		0.59
D	32.05	32.15	32.25
D1	2.10		
D2	1.85		
D3	30.65	30.75	30.85
E	12.35	12.45	12.55
e	1.70	1.80	1.90
e1	2.40	2.50	2.60
eB1	16.10	16.40	16.70
eB2	21.18	21.48	21.78
L	0.85	1.05	1.25
Dia	3.10	3.20	3.30

Revision history

Table 17. Document revision history

Date	Revision	Changes
08-Sep-2014	1	Initial release.
29-Oct-2014	2	<ul style="list-style-type: none"> – Minor text edits throughout the document. – Updated <i>Figure 1, 4, 7, 9 and 10</i>. – Added <i>Figure 6 and Figure 7</i>. – Updated values for the I_{SDH} and I_{SDI} parameters in <i>Table 10: Logic inputs</i>. – Added footnote to <i>Table 12</i>. – Removed NTC thermistor table and “Resistance variation vs. temperature” equation from <i>Section 3.1.1: NTC thermistor</i>
07-Nov-2014	3	Minor text and formatting edits throughout document.
24-Jul-2015	4	Minor text and formatting edits throughout document. Updated cover page package image. Updated <i>Table 3, Table 6, Table 7, Table 8, Table 9, and Table 10</i> Added <i>Section 7: Electrical characteristics (curves)</i>
21-Aug-2015	5	Modified: <i>Figure 13</i> Minor text changes
09-Dec-2015	6	Modified: Features Minor text changes
17-Mar-2017	7	Modified features on cover page. Modified <i>Table 7: "Static"</i> , <i>Table 8: "Inductive load switching time and energy"</i> . Modified <i>Figure 2: "Switching time test circuit"</i> . Modified <i>Table 9: "Low voltage power supply"</i> , <i>Table 12: "Op-amp characteristics"</i> . Modified <i>Figure 4: "Internal structure of SD and NTC"</i> . Modified <i>Figure 10: "Application circuit example"</i> . Minor text changes.
15-Oct-2018	8	Removed maturity status indication from cover page. Updated package silhouette on cover page. Updated <i>Section 4 Shutdown function and Section 5.1 Guidelines</i> . Updated <i>Section 6 Electrical characteristics (curves)</i> . Minor text changes
01-Mar-2019	9	Added <i>Figure 2. Pin layout (top view) - N2DIP-26L type L and Figure 3. Pin layout (top view) - N2DIP-26L type Z</i> . Modified <i>Figure 11. Shutdown timing waveforms</i> . Minor text changes.

Contents

1	Internal schematic diagram and pin configuration	2
2	Electrical ratings	5
2.1	Absolute maximum ratings	5
2.2	Thermal data	5
3	Electrical characteristics	7
3.1	Inverter part	7
3.2	Control part	9
3.2.1	NTC thermistor	12
3.3	Waveform definitions	14
4	Shutdown function	15
5	Application circuit example	16
5.1	Guidelines	17
6	Electrical characteristics (curves)	18
7	Package information	20
7.1	N2DIP-26L type L package information	20
7.2	N2DIP-26L type Z package information	21
7.3	N2DIP-26L packing information	23
	Revision history	25

IMPORTANT NOTICE – PLEASE READ CAREFULLY

STMicroelectronics NV and its subsidiaries (“ST”) reserve the right to make changes, corrections, enhancements, modifications, and improvements to ST products and/or to this document at any time without notice. Purchasers should obtain the latest relevant information on ST products before placing orders. ST products are sold pursuant to ST’s terms and conditions of sale in place at the time of order acknowledgement.

Purchasers are solely responsible for the choice, selection, and use of ST products and ST assumes no liability for application assistance or the design of Purchasers’ products.

No license, express or implied, to any intellectual property right is granted by ST herein.

Resale of ST products with provisions different from the information set forth herein shall void any warranty granted by ST for such product.

ST and the ST logo are trademarks of ST. All other product or service names are the property of their respective owners.

Information in this document supersedes and replaces information previously supplied in any prior versions of this document.

© 2019 STMicroelectronics – All rights reserved

Данный компонент на территории Российской Федерации

Вы можете приобрести в компании MosChip.

Для оперативного оформления запроса Вам необходимо перейти по данной ссылке:

<http://moschip.ru/get-element>

Вы можете разместить у нас заказ для любого Вашего проекта, будь то серийное производство или разработка единичного прибора.

В нашем ассортименте представлены ведущие мировые производители активных и пассивных электронных компонентов.

Нашей специализацией является поставка электронной компонентной базы двойного назначения, продукции таких производителей как XILINX, Intel (ex.ALTERA), Vicor, Microchip, Texas Instruments, Analog Devices, Mini-Circuits, Amphenol, Glenair.

Сотрудничество с глобальными дистрибьюторами электронных компонентов, предоставляет возможность заказывать и получать с международных складов практически любой перечень компонентов в оптимальные для Вас сроки.

На всех этапах разработки и производства наши партнеры могут получить квалифицированную поддержку опытных инженеров.

Система менеджмента качества компании отвечает требованиям в соответствии с ГОСТ Р ИСО 9001, ГОСТ РВ 0015-002 и ЭС РД 009

Офис по работе с юридическими лицами:

105318, г.Москва, ул.Щербаковская д.3, офис 1107, 1118, ДЦ «Щербаковский»

Телефон: +7 495 668-12-70 (многоканальный)

Факс: +7 495 668-12-70 (доб.304)

E-mail: info@moschip.ru

Skype отдела продаж:

moschip.ru

moschip.ru_4

moschip.ru_6

moschip.ru_9