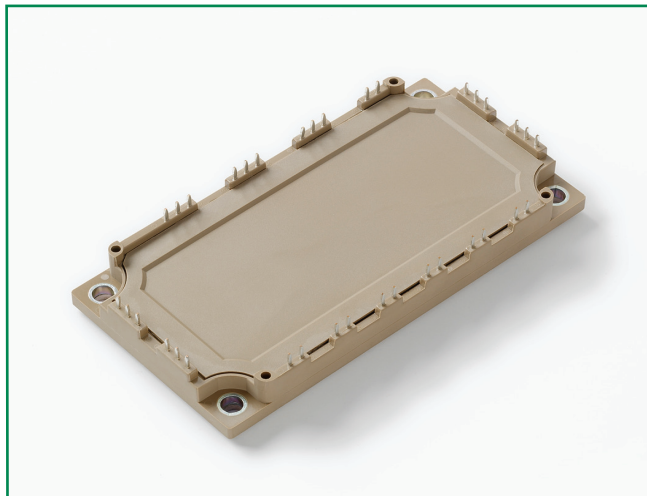

### MG12100W-XN2MM

#### Features

- High level of integration
- IGBT<sup>3</sup> CHIP(Trench+Field Stop technology)
- Low saturation voltage and positive temperature coefficient
- Fast switching and short tail current
- Free wheeling diodes with fast and soft reverse recovery
- Solderable pins for PCB mounting
- Temperature sense included

#### Applications

- AC motor control
- Motion/servo control
- Inverter and power supplies

#### Module Characteristics ( $T_J = 25^\circ\text{C}$ , unless otherwise specified)

Symbol	Parameters	Test Conditions	Min	Typ	Max	Unit
$T_{J(max)}$	Max. Junction Temperature				150	$^\circ\text{C}$
$T_{J(op)}$	Operating Temperature		-40		125	$^\circ\text{C}$
$T_{stg}$	Storage Temperature		-40		125	$^\circ\text{C}$
$V_{isol}$	Insulation Test Voltage	AC, t=1min		3000		V
CTI	Comparative Tracking Index		250			
$M_d$	Mounting Torque	Recommended (M5)	2.5		5	N·m
Weight				300		g

#### Absolute Maximum Ratings ( $T_J = 25^\circ\text{C}$ , unless otherwise specified)

Symbol	Parameters	Test Conditions	Values	Unit
<b>IGBT</b>				
$V_{CES}$	Collector - Emitter Voltage	$T_J=25^\circ\text{C}$	1200	V
$V_{GES}$	Gate - Emitter Voltage		$\pm 20$	V
$I_C$	DC Collector Current	$T_C=25^\circ\text{C}$	140	A
		$T_C=80^\circ\text{C}$	100	A
$I_{CM}$	Repetitive Peak Collector Current	$t_p=1\text{ms}$	200	A
$P_{tot}$	Power Dissipation Per IGBT		450	W
<b>Diode</b>				
$V_{RRM}$	Repetitive Reverse Voltage	$T_J=25^\circ\text{C}$	1200	V
$I_{F(AV)}$	Average Forward Current	$T_C=25^\circ\text{C}$	140	A
		$T_C=80^\circ\text{C}$	100	A
$I_{FRM}$	Repetitive Peak Forward Current	$t_p=1\text{ms}$	200	A
$I^2t$		$T_J=125^\circ\text{C}$ , t=10ms, $V_R=0\text{V}$	1850	$\text{A}^2\text{s}$

### Electrical and Thermal Specifications ( $T_J = 25^\circ\text{C}$ , unless otherwise specified)

Symbol	Parameters	Test Conditions	Min	Typ	Max	Unit
<b>IGBT</b>						
$V_{GE(th)}$	Gate - Emitter Threshold Voltage	$V_{CE}=V_{GE}, I_C=4.0\text{mA}$	5.0	5.8	6.5	V
$V_{CE(sat)}$	Collector - Emitter	$I_C=100\text{A}, V_{GE}=15\text{V}, T_J=25^\circ\text{C}$		1.7		V
	Saturation Voltage	$I_C=100\text{A}, V_{GE}=15\text{V}, T_J=125^\circ\text{C}$		1.9		V
$I_{ICES}$	Collector Leakage Current	$V_{CE}=1200\text{V}, V_{GE}=0\text{V}, T_J=25^\circ\text{C}$			1	mA
		$V_{CE}=1200\text{V}, V_{GE}=0\text{V}, T_J=125^\circ\text{C}$			10	mA
$I_{GES}$	Gate Leakage Current	$V_{CE}=0\text{V}, V_{GE}=\pm 15\text{V}, T_J=125^\circ\text{C}$	-400		400	nA
$R_{Gint}$	Integrated Gate Resistor			7.5		$\Omega$
$Q_{ge}$	Gate Charge	$V_{CE}=600\text{V}, I_C=100\text{A}, V_{GE}=\pm 15\text{V}$		0.9		$\mu\text{C}$
$C_{ies}$	Input Capacitance	$V_{CE}=25\text{V}, V_{GE}=0\text{V}, f=1\text{MHz}$		7.1		nF
$C_{RES}$	Reverse Transfer Capacitance				0.3	
$t_{d(on)}$	Turn - on Delay Time	$V_{CC}=600\text{V}$ $I_C=100\text{A}$ $R_G=3.9\Omega$ $V_{GE}=\pm 15\text{V}$ Inductive Load	$T_J=25^\circ\text{C}$		260	ns
			$T_J=125^\circ\text{C}$		290	ns
$t_r$	Rise Time		$T_J=25^\circ\text{C}$		30	ns
			$T_J=125^\circ\text{C}$		50	ns
$t_{d(off)}$	Turn - off Delay Time		$T_J=25^\circ\text{C}$		420	ns
			$T_J=125^\circ\text{C}$		520	ns
$t_f$	Fall Time		$T_J=25^\circ\text{C}$		70	ns
			$T_J=125^\circ\text{C}$		90	ns
$E_{on}$	Turn - on Energy		$T_J=25^\circ\text{C}$		7.8	mJ
			$T_J=125^\circ\text{C}$		10	mJ
$E_{off}$	Turn - off Energy	$T_J=25^\circ\text{C}$		8	mJ	
		$T_J=125^\circ\text{C}$		10	mJ	
$I_{SC}$	Short Circuit Current	$t_{psc}\leq 10\mu\text{s}, V_{GE}=15\text{V}, T_J=125^\circ\text{C}, V_{CC}=900\text{V}$		400		A
$R_{thJC}$	Junction-to-Case Thermal Resistance (Per IGBT)				0.28	K/W
<b>Diode</b>						
$V_F$	Forward Voltage	$I_F=100\text{A}, V_{GE}=0\text{V}, T_J=25^\circ\text{C}$		1.65		V
		$I_F=100\text{A}, V_{GE}=0\text{V}, T_J=125^\circ\text{C}$		1.65		V
$t_{RR}$	Reverse Recovery Time	$I_F=100\text{A}, V_R=600\text{V}$ $di_F/dt=2400\text{A}/\mu\text{s}$ $T_J=125^\circ\text{C}$		320		ns
$I_{RRM}$	Max. Reverse Recovery Current			105		A
$E_{rec}$	Reverse Recovery Energy			9.5		mJ
$R_{thJCD}$	Junction-to-Case Thermal Resistance (Per Diode)				0.5	K/W

### NTC Characteristics ( $T_J = 25^\circ\text{C}$ , unless otherwise specified)

Symbol	Parameters	Test Conditions	Min	Typ	Max	Unit
$R_{25}$	Resistance	$T_c=25^\circ\text{C}$		5		K $\Omega$
$B_{25/50}$				3375		K

**Figure 1: Typical Output Characteristics for IGBT Inverter**

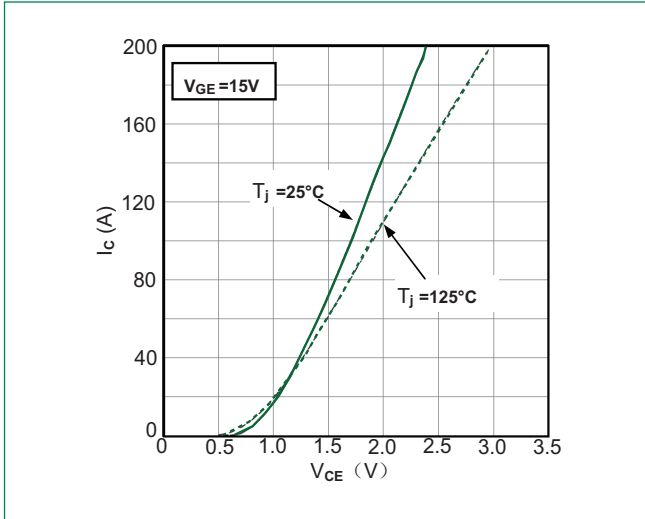

**Figure 2: Typical Output Characteristics for IGBT Inverter**

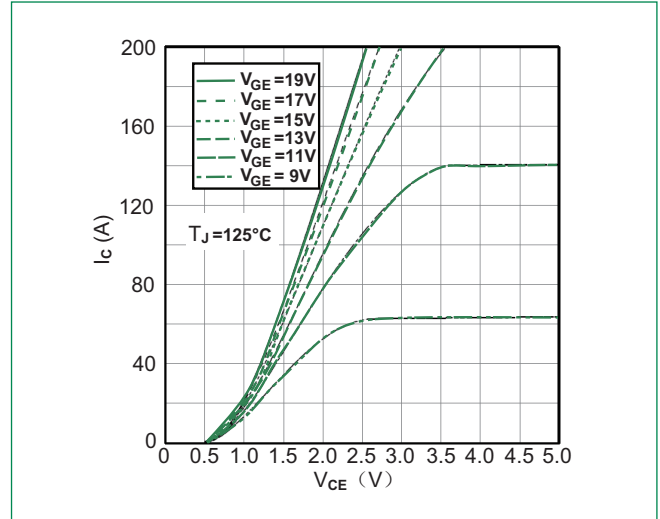

**Figure 3: Typical Transfer Characteristics for IGBT Inverter**

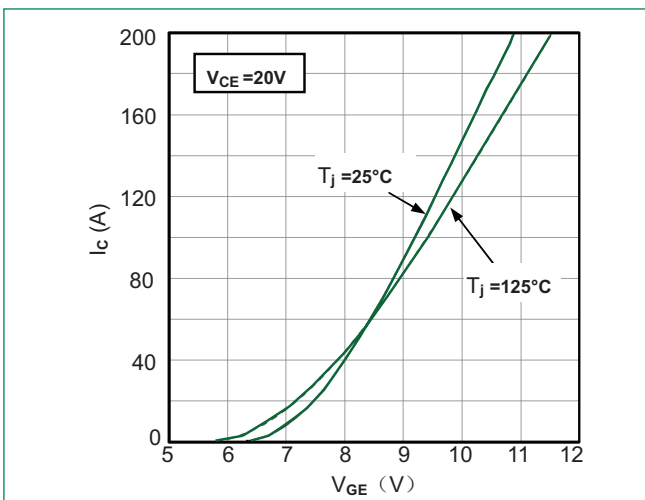

**Figure 4: Switching Energy vs. Gate Resistor for IGBT Inverter**

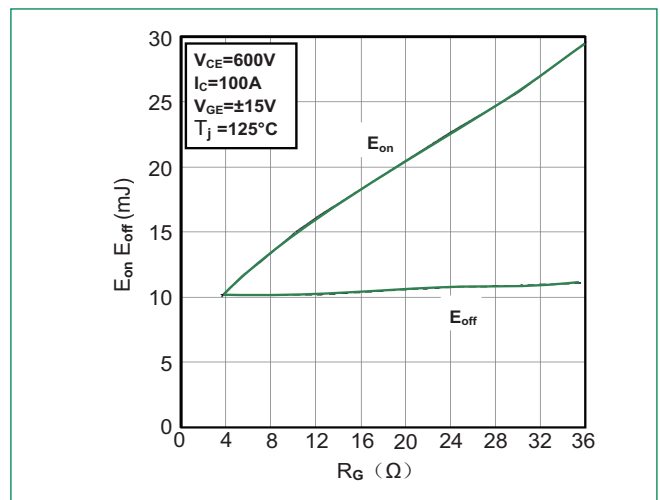

**Figure 5: Switching Energy vs. Collector Current for IGBT Inverter**

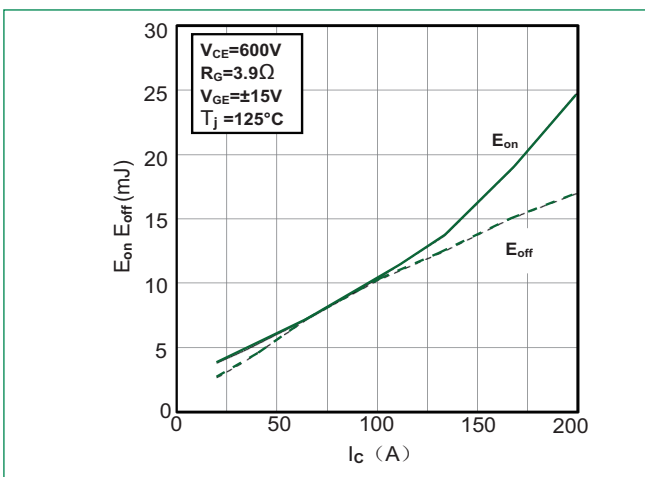

**Figure 6: Reverse Biased Safe Operating Area for IGBT Inverter**

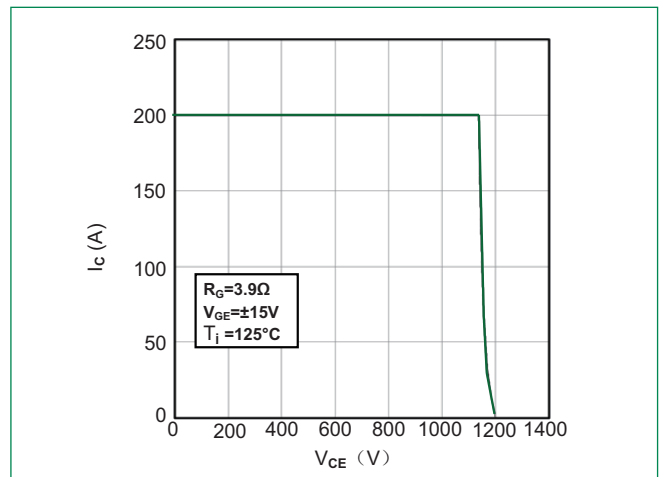

**Figure 7: Diode Forward Characteristics for Diode Inverter**

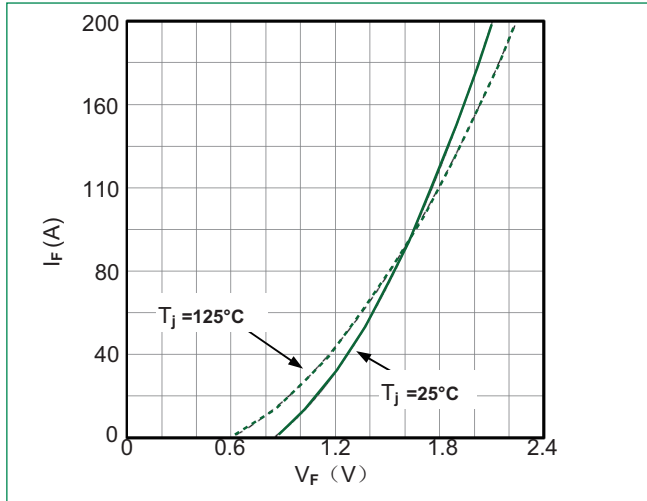

**Figure 8: Switching Energy vs. Gate Resistort for Diode Inverter**

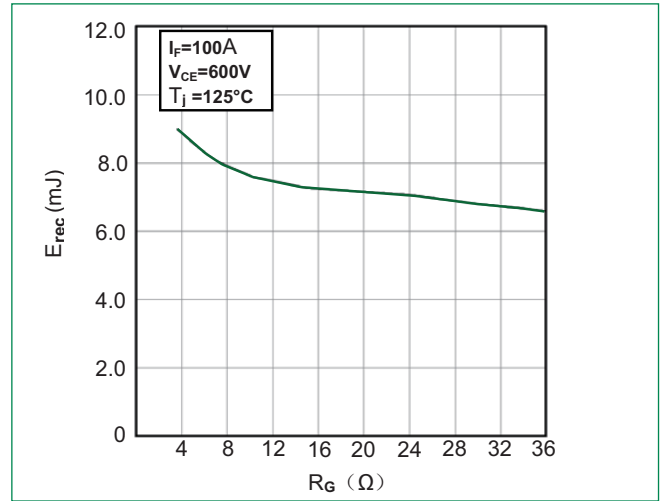

**Figure 9: Switching Energy vs. Forward Current for Diode Inverter**

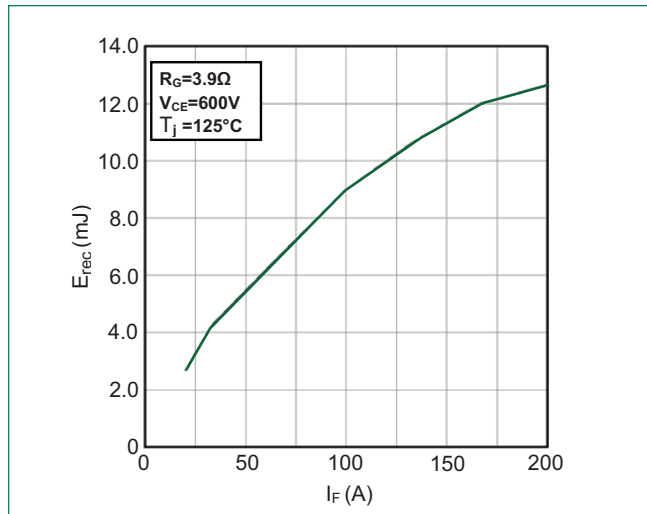

**Figure 10: Transient Thermal Impedance of Diode and IGBT Inverter**

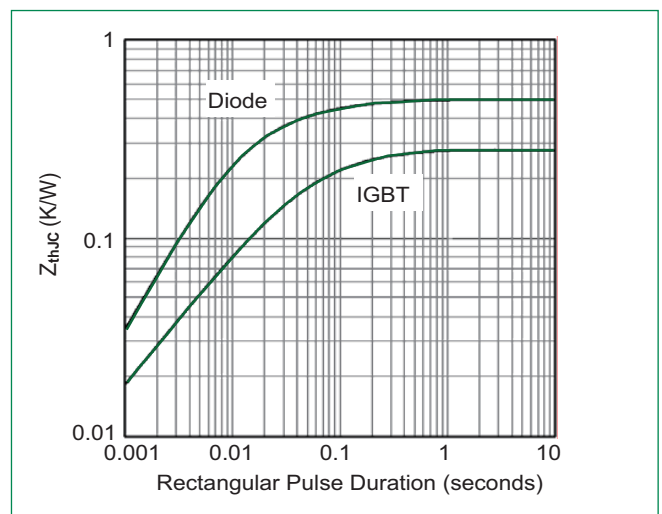

**Figure 11: NTC Characteristics**

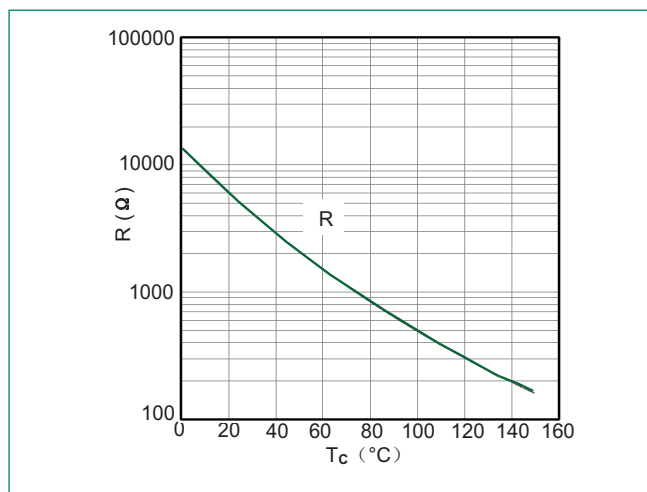

## Circuit Diagram

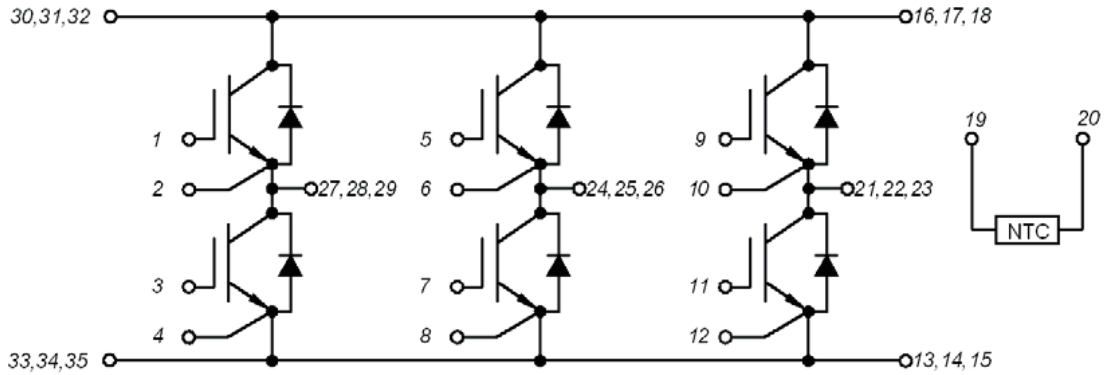

## Part Numbering System

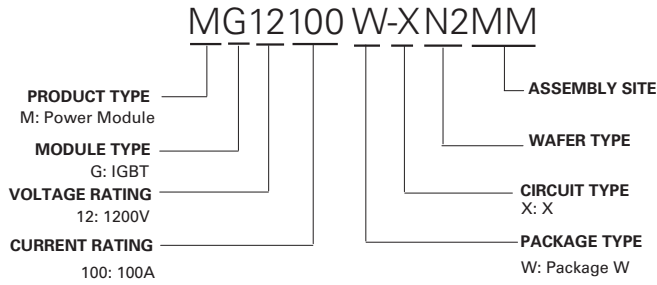

## Part Marking System

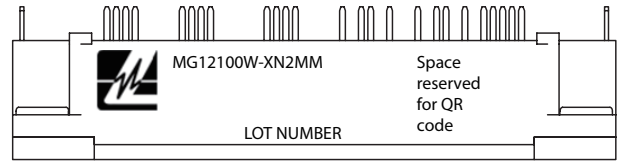

## Packing Options

Part Number	Marking	Weight	Packing Mode	M.O.Q
MG12100W-XN2MM	MG12100W-XN2MM	300g	Bulk Pack	20

**Dimensions-Package W**

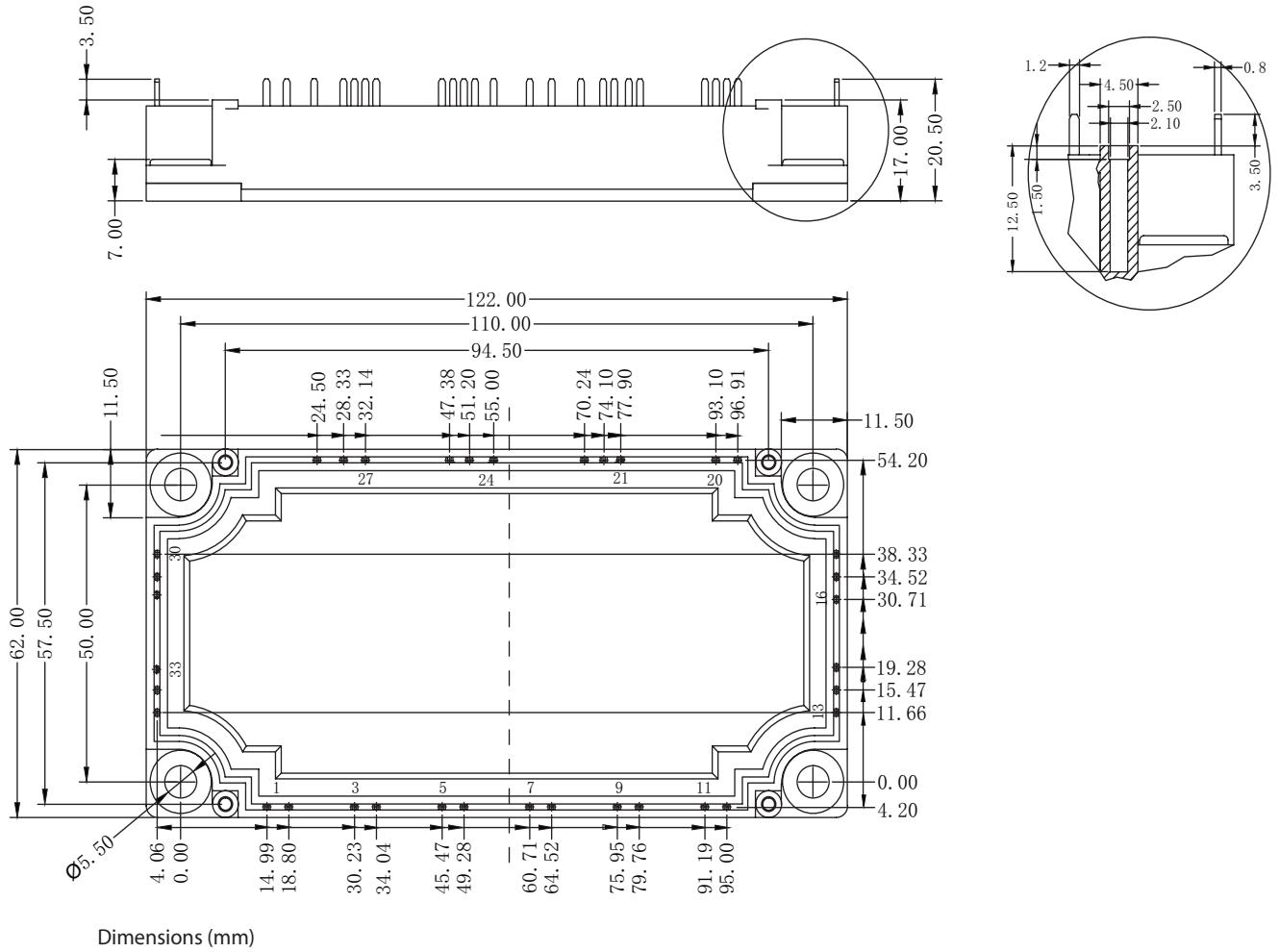

## Данный компонент на территории Российской Федерации

### Вы можете приобрести в компании MosChip.

Для оперативного оформления запроса Вам необходимо перейти по данной ссылке:

<http://moschip.ru/get-element>

Вы можете разместить у нас заказ для любого Вашего проекта, будь то серийное производство или разработка единичного прибора.

В нашем ассортименте представлены ведущие мировые производители активных и пассивных электронных компонентов.

Нашей специализацией является поставка электронной компонентной базы двойного назначения, продукции таких производителей как XILINX, Intel (ex.ALTERA), Vicor, Microchip, Texas Instruments, Analog Devices, Mini-Circuits, Amphenol, Glenair.

Сотрудничество с глобальными дистрибьюторами электронных компонентов, предоставляет возможность заказывать и получать с международных складов практически любой перечень компонентов в оптимальные для Вас сроки.

На всех этапах разработки и производства наши партнеры могут получить квалифицированную поддержку опытных инженеров.

Система менеджмента качества компании отвечает требованиям в соответствии с ГОСТ Р ИСО 9001, ГОСТ РВ 0015-002 и ЭС РД 009

### Офис по работе с юридическими лицами:

105318, г.Москва, ул.Щербаковская д.3, офис 1107, 1118, ДЦ «Щербаковский»

Телефон: +7 495 668-12-70 (многоканальный)

Факс: +7 495 668-12-70 (доб.304)

E-mail: [info@moschip.ru](mailto:info@moschip.ru)

Skype отдела продаж:

moschip.ru

moschip.ru\_4

moschip.ru\_6

moschip.ru\_9