

**Pro Audio & Broadcast Catalog**  
Sixth Edition

# Switchcraft®

**Switchcraft®**  
www.switchcraft.com



Patchbays, Patchcords & Molded Cable Assemblies



Connectors and Adapters



Jacks and Plugs



Guitar Switches

## About Switchcraft, Inc.

Switchcraft, Inc. was established in 1946 to manufacture jacks, plugs, and switches. We have since become the industry leader in producing a wide variety of connectors, adapters, jacks and plugs, patchbays, jackfields, and switches. While our products cover a diverse number of markets, this catalog focuses on our line of audio and video products, typically found in broadcast, recording, sound reinforcement, and other pro audio applications.

Some of the new products you'll find in this catalog include our EZ Norm Series of audio patchbays, where normal configurations can be changed from the front of the patchbay, using a standard screwdriver. Also found in this edition are new combination audio/video patchbays in both standard/long-frame and midsize/bantam styles. In the connector section, we're offering a new line of connectors called our EH Series, incorporating a wide range of connectors (Firewire, USB, Category 6, BNC, RCA, and more) in a standard XLR housing.

Please keep in mind that this is just a small sampling of our complete product lines. For more detailed information, we offer our "full line" catalog, our Engineering Design Guide.

Our Engineering Design Guide includes over 5,000 part numbers covering all five major product lines. If you don't see it here, chances are you'll find it in the EDG. And again, keep in mind that the EDG is also just a "snapshot" of our capabilities. We manufacture over 30,000 part numbers, so if it's not in the EDG, please contact us with your requirements. To keep up on all the new products we have to offer, visit our website at [www.switchcraft.com](http://www.switchcraft.com) and look for the New Product Showcase.

*Patchbay Series* 4 – 43

*Patchcords/Molded Cables* 44 – 45

*Connector Series* 46 – 62

*Audio Adapter Series* 63 – 64

*Jack Series* 65 – 82

*Plug Series* 83 – 93

*Switch Series* 94 – 96

*Index* 98 – 100

## 2 Table of Contents

### Patchbays

|   |       |
|---|-------|
| Professional Punchdown Terminal (PPT) ..... | 4     |
| Audio Patchbay Series .....                 | 5-33  |
| MTPH/TTPH Harness Series .....              | 5-7   |
| Front Access Series .....                   | 8-9   |
| EZ Norm Patchbay Series .....               | 10-11 |
| RS 422 Data Patchbay Series .....           | 12-13 |
| MTP48K Wired Series .....                   | 14-15 |
| TTPW96K Wired Series .....                  | 16-17 |
| MTPBP/TTPBP Backpanel Series .....          | 18-19 |
| TT96 EDAC Series .....                      | 20-21 |
| TTP96K Patchkit Series .....                | 22-23 |
| MT48K/MT52K Patchkit Series .....           | 24-25 |
| MT48/MT52 Patchbay Series .....             | 26-27 |
| TTP96AS Patchbay Series.....                | 28-29 |
| HPC Patchbay Series .....                   | 30-31 |
| Q-G® Patchbay Series .....                  | 32-33 |
| Video/Audio Patchbay Series.....            | 34-44 |
| VPP Video Patchbay Series.....              | 34-36 |
| MVP Midsize Video Patchbay Series .....     | 37-39 |
| VAP Video/Audio Patchbay Series .....       | 40-41 |
| MVEZN Audio/Midsize Patchbay Series.....    | 42    |
| MBPK Video/Audio Patchbay Series .....      | 43    |
| Audio and Video Patchcords .....            | 44-45 |

### Connectors

|   |       |
|---|-------|
| Q-G® Audio Connector Series .....                                     | 46-48 |
| A, AA, AAA Cord Style Series .....                                    | 46    |
| B, C, D, E Panel Style Series.....                                    | 47    |
| J, K, P, R, T Wallplate, Gooseneck,<br>Panel & Cord Style Series..... | 48    |
| Tini-Q-G® Connector Series .....                                      | 49    |
| Tini-Q-G® Cord & Panel Style Series .....                             | 49    |
| HPC Connector Series .....  | 50-51 |
| HPC Panel Style Series .....  | 50    |
| HPC Cord, & Adapter Style Series.....                                 | 51    |
| EH Series Receptacles .....   | 52    |
| MIDI and 2500 Series .....  | 53    |
| HP75BNC Series .....  | 54    |
| Connector Dimension Drawings .....                                    | 55-62 |
| HP75BNC Series, EH Series .....                                       | 55    |
| Q-G Audio - A, AA, AAA Series .....                                   | 56    |
| Q-G Audio - B, C, D, E Series .....                                   | 57    |
| Q-G Audio - J, K, P, R Series.....                                    | 58    |
| Q-G Audio - T Series .....  | 59    |
| MIDI, Q-G Audio - P Series .....                                      | 60    |
| HPC Panel Style Series .....  | 61-62 |

### Audio Adapters

|  |    |
|--|----|
| XLR to XLR, RCA, 1/4", TQ-G Adapter Series .....                       | 63 |
| 1/4" to 1/4", RCA; RCA to RCA;<br>& Miscellaneous Adapter Series ..... | 64 |

## Jacks & Plugs

### Jack Series

|   |       |
|---|-------|
| Littel Phone, Hi-D, Right Angle PC Mount 1/4", 1/4" Extension Jack Series ..... | 65    |
| Thick Panel/Guitar, Locking 1/4", Tini, Tini-Extension, Micro, 3.5mm .....      | 67    |
| Phono, Phono Extension, TT or Bantam, MT 1/4" Jack Series .....                 | 69    |
| Power/Jacks Plugs Series – 700, S700, 800 Cord & Panel Style Series .....       | 71    |
| Jack Series Dimension Drawings .....  | 72–82 |
| Littel Phone, Hi-D, 1/4" Extension, 700 Panel Jack Series .....                 | 72    |
| Littel Phone, Hi-D, 1/4" Extension Jack Series .....                            | 73    |
| Right Angle PC Mount 1/4" Jack Series .....                                     | 74    |
| Thick Panel/Guitar, Locking 1/4", Tini, Tini Extension Jack Series .....        | 75    |
| Micro, 3.5mm Jack Series .....  | 76    |
| 3.5mm Jack Series.....  | 77–79 |
| Phono and Phono Extension Jack Series .....                                     | 80    |
| TT or Bantam Jack Series.....   | 81    |
| MT 1/4" Jack Series.....  | 82    |

### Plug Series

|  |       |
|--|-------|
| Littel 1/4", Right Angle 1/4", Silent, Super Heavy Duty Plug Series .....                        | 83    |
| Tini, Micro, 3.5mm Stereo, Right Angle 3.5mm Stereo, Phono, Right Angle Phono Plugs Series ..... | 85    |
| TT or Bantam, Mil-Style 1/4" Plugs Series .....  | 87    |
| Plug Series Dimension Drawings .....   | 88–93 |
| Littel Plug 1/4" Series .....  | 88    |

|   |    |
|---|----|
| Littel Right Angle 1/4", Silent, Super Heavy Duty Plug Series ..... | 89 |
| Tini, Micro Plug Series .....                                       | 90 |
| 35HD 3.5mm Stereo Plug Series .....                                 | 91 |
| Phono and Phone Right Angle Plug Series .....                       | 92 |
| TT or Bantam, Mil-Style 1/4" Plug Series .....                      | 93 |

### Switches

|  |       |
|--|-------|
| Switch Series .....                    | 94–95 |
| Switch Series Dimension Drawings ..... | 96    |

### Limited Lifetime Warranty

Switchcraft warrants all of its products to be of sound design, good materials and workmanship at the time of manufacture.

Switchcraft will repair or replace at its discretion any product proven to be defective under normal use.

Switchcraft's liability under the terms of this warranty is limited to the repair or replacement of defective products which have not been damaged through accident, abuse, misuse or unauthorized repair. Switchcraft shall in no case be liable for special or consequential damages of any nature.



# PATCHBAYS

## 4 Our Patchbays Now Feature the New Professional Punchdown Terminal (PPT)

### Our Patchbays Have Just Rounded A New Corner

Actually, the corners we rounded belong to our patchbays' revolutionary, new Professional Terminal (PPT), making it perfectly compatible with the industry standard. We realized that achieving a new industry standard meant we couldn't cut any corners to get there.

The PPT design incorporates a split-barrel design and a more rugged, thicker housing to minimize the impact of repeated punchdowns. The split-barrel design eliminates the problems associated with the old "V-shaped" terminal designs. The PPT design distributes pressure evenly across both sides of the terminated wire, causing improved wire retention plus more reliable connections. The serrated teeth in the plastic housing firmly grip the wires, which also greatly improves wire retention. With the PPT, multiple wires can be terminated to a single contact, and a wide range of wire gauges can be used.

Look for Switchcraft's PPT in our MTP and TTP Series of audio patchbays, and in our new Backpanel Series. All Switchcraft audio patchbays incorporate heavy gauge materials and our high quality nickel-plated, steel framed jacks. Gold-plated, crossbar contacts come standard!



### Materials

Housing: Thermoplastic (UL 94V-0)

Contacts: High strength copper alloy, tin plated

Wire size: Accommodates #22, 24, or 26 AWG, stranded or solid

### Accessories

| Part Number  | Description   |
|--------------|---|
| <b>K459</b>  | PPT replacement kit consists of 15 of each color* (IDC/IDC)     |
| <b>K460</b>  | PPT replacement kit consists of 15 of each color (IDC/wirewrap) |
| <b>PT1LA</b> | PPT impact punchdown tool                                       |
| <b>PT2B</b>  | Replacement bit for PT1LA tool                                  |

*\*Colors consist of red, black, white, yellow, blue, and orange.*

# Switchcraft

### MTPH/TPH Harness Series

#### Features and Benefits

- Units feature either 48 MT style jacks or 96 TT style jacks on the front panels, to a 4 foot harness, out to a backpanel with PPT's
- All versions utilize AES/EBU wiring for complete digital compatibility
- Attractive, corrosion resistant nickel-plated, steel frame jacks
- Gold-plated switching contacts reduce contact resistance, improve reliability

#### Specifications

##### Materials

##### Jacks

- Frame: Nickel-plated steel
- Bushing: Nickel-plated brass
- Tip, Ring and Shunt Springs: Nickel silver with welded contacts
- Assembly Screws: Zinc-plated steel
- Welded Contacts: Gold alloy

##### Panel

- Front Channel: Black anodized aluminum
- Frame: C.R.S. black epoxy painted
- Designation Strips: Black polycarbonate 94V-0
- Designation Strip Covers: Clear polycarbonate
- Jack Inserts: Thermoplastic polyester

##### Mechanical

- Life: 30,000 cycles
- Insertion Force: 7 lbs. maximum
- Withdrawal Force: 1 lb. minimum
- Environmental: 0°C to +50°C

##### Electrical

- Contact Resistance: 30 milliohms maximum initial
- Insulation Resistance: 10,000 megohms maximum
- Dielectric Withstanding Voltage: 500 VAC at 60 Hz
- Working Voltage: 140 VDC maximum
- Current Rating: 100 milliamps



The MTPH and TPH Harness Series utilize standard front panel assemblies, a 4-foot cable harness, and our standard back panel assemblies. Primarily used where the back panels must either be mounted into a rack, or brought back to the front for easier access. Custom cable lengths can also be supplied. Contact the factory for details.

#### Ordering Information

| Part Number | Type of Jack | No. of Jacks | Description   |
|-------------|--------------|--------------|---|
| MTPH48K1NS  | MT           | 48           | 1.75" High front panel, 4' Harness, 3.5" High back panel, normals strapped          |
| MTPH48K1NO  | MT           | 48           | 1.75" High front panel, 4' Harness, 3.5" High back panel, normals brought out       |
| MTPH48K3NS  | MT           | 48           | 3.5" High front panel, 4' Harness, 3.5" High back panel, normals strapped           |
| MTPH48K3NO  | MT           | 48           | 3.5" High front panel, 4' Harness, 3.5" High back panel, normals brought out        |
| MTPH48K3SNO | MT           | 48           | 3.5" High front panel, 4' Harness, 3.5" High back panel, sleeve normals brought out |
| TPPH96K1NS  | TT           | 96           | 1.75" High front panel, 4' Harness, 3.5" High back panel, normals strapped          |
| TPPH96K1NO  | TT           | 96           | 1.75" High front panel, 4' Harness, 5.25" High back panel, normals brought out      |
| TPPH96K3NS  | TT           | 96           | 3.5" High front panel, 4' Harness, 3.5" High back panel, normals strapped           |
| TPPH96K3NO  | TT           | 96           | 3.5" High front panel, 4' Harness, 5.25" High back panel, normals brought out       |

See Next Page for Mechanical Drawings

# PATCHBAYS

## 6 MTPH/TPH Harness Series

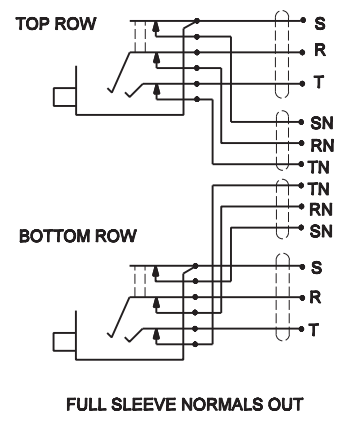
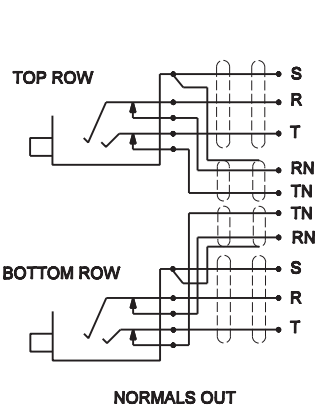
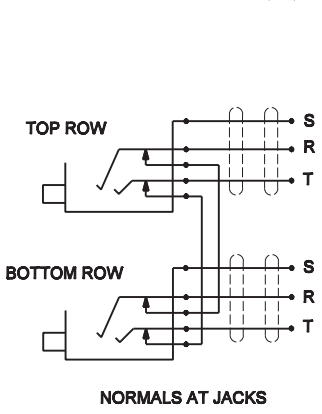

## MTPH/TPPH Harness Series



DIMENSIONS ARE FOR REFERENCE ONLY

Inch  
(mm)



# PATCHBAYS

8

## Front Access Series

### Features and Benefits

- Easy slide-out tray slides forward for easy re-termination from the front of the rack
- Available with either 48 MT style or 96 TT style jacks in a 1RU space
- Attractive, corrosion resistant nickel-plated, steel frame jacks
- Gold-plated switching contacts reduce contact resistance, improves reliability
- Extra wide designation strips for easy channel identification
- Rugged, attractive black epoxy-finished steel chassis
- Configurations available include normals strapped and normals brought out

### Specifications

#### Materials

##### Jacks

- Frame: Nickel-plated steel
- Bushing: Nickel-plated brass
- Tip, Ring and Shunt Springs: Nickel silver with welded contacts
- Assembly Screws: Nickel-plated steel
- Welded Contacts: Gold alloy

##### Panel

- Frame: C.R.S. black epoxy painted
- Designation Strips: Black polycarbonate 94V-0
- Designation Strip Covers: Clear polycarbonate
- Jack Inserts: Thermoplastic 94V-0

#### Mechanical

- Life: 30,000 cycles
- Insertion Force: 7 lbs. maximum
- Withdrawal Force: 1 lb. minimum
- Operating: -20°C to +65°C

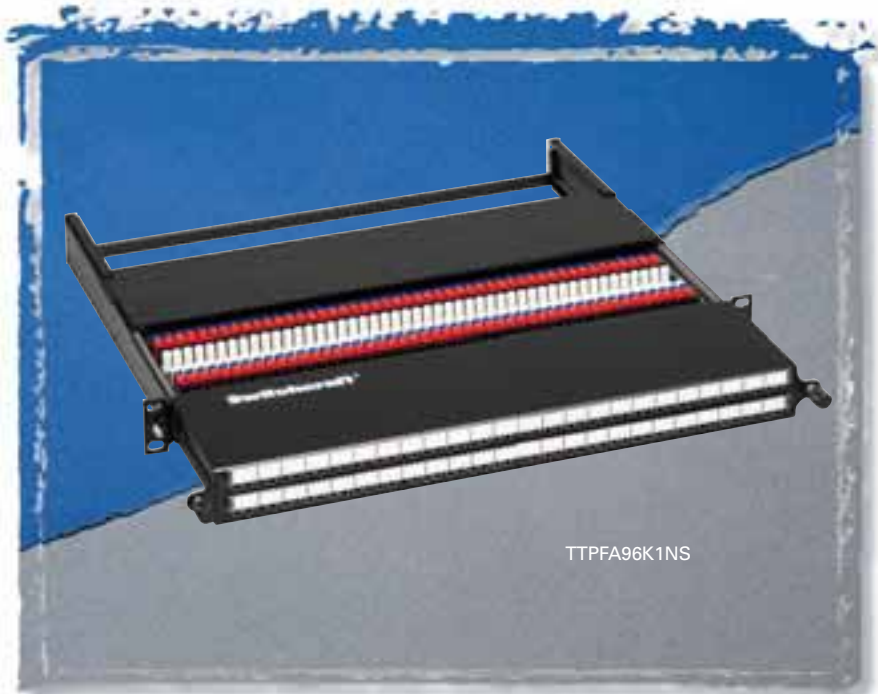

The Front Access Series offers the end user the ease of re-terminating patchpoints from the front of the rack as opposed to the back. A slide out tray allows the user to slide out the punchdown terminals and reconfigure the unit. An easy release mechanism on either side of the unit allows it to be pushed back into place and easy to grip locking nuts tighten the unit in place.

#### Electrical

- Jack Contact Resistance: 30 milliohms initial maximum; 50 milliohms after life
- Jack Insulation Resistance: 10,000 megohms maximum
- Dielectric Withstanding Voltage: 500V at 60 Hz AC
- Working Voltage: 100 milliamps or less; maximum 56.5 VDC

#### Ordering Information

| Part Number | Type of Jack | No. of Jacks | Description                     |
|-------------|--------------|--------------|---------------------------------|
| TTPFA96K1NS | TT           | 96           | 1.75" High, normals strapped    |
| TTPFA96K1NO | TT           | 96           | 1.75" High, normals brought out |
| MTPFA48K1NS | MT           | 48           | 1.75" High, normals strapped    |
| MTPFA48K1NO | MT           | 48           | 1.75" High, normals brought out |

# Switel

# PATCHBAYS

## Front Access Series



DIMENSIONS ARE FOR REFERENCE ONLY

Inch  
(mm)

**Switchcraft**  
www.switchcraft.com

5555 North Elston Avenue / Chicago, IL 60630  
Phone: 773-792-2700 / Fax: 773-792-2129

# PATCHBAYS

## 10 EZ Norm Patchbay Series



Center Strip Removes For Normalling Access



Easily Normal The Jacks By Rotating To "Full", "Non," Or "Half" Positions

The EZ Norm offers a simplified method for setting up and changing normals to a Bantam/TT patchbay. Simply remove the middle designation strip, and rotate the center cam, using a standard screwdriver. An audible "click" can be heard as you rotate from full normals to no normals to half normals. An opaque marking strip is included to conceal the normal position, if needed.

### Specifications

#### Materials

##### Jacks

Housing & Cover: 94V-0 rated thermoplastic  
Sleeve Collar: Nickel plated copper alloy  
Tip, Ring, Shunt, & Sleeve Springs: Nickel Silver with welded contacts  
Welded Contacts: Gold  
Cam Switching Springs: Silver plated copper alloy  
Cam Switching Contacts: Silver plated copper alloy

#### Mechanical

Jack Mechanical Life: 30,000 cycles  
Cam Contact Mechanical Life: 30,000 cycles  
Insertion - Withdrawal Forces: 1 - 4 lbs.  
Moisture resistance: MIL-STD 202 Method 106  
Thermal shock: MIL-STD 202 Method 107  
Salt spray: MIL-STD Method 101 (48 hrs.)  
Vibration: MIL-STD 202 Method 213

#### Electrical

Jack Spring Contact Resistance: 30 milliohm Maximum  
Cam Switch Contact Resistance: 30 milliohm Maximum  
Insulation Resistance: 10,000 Megaohms  
Dielectric Withstanding Voltage: 500 VAC (rms) at 60 Hz  
Insertion Loss: -0.5dB up to 10 MHz

#### EZ Norm Patchbay Options

- 1RU can be terminated to EDAC or Cannon DL, solder terminals, or wire-wrap terminals
- 1.5RU can be terminated to EDAC/Cannon DL, solder terminals, wire-wrap terminals, plus 3 pin connectors, or our own PPT Professional Punchdown Terminal
- 2RU Same as above
- All units will be offered with or w/o docking connector
- Unwired units will be offered with either cable tie bar or cable tray

# Switel

# PATCHBAYS

## EZ Norm Patchbay Series 11

### Racks

The EZ Norm comes in 3 different rack heights, 1RU, 1.5RU, and 2 RU.



### Harness Assembly

The EZ Norm is also offered as a harness assembly, with a standard harness of 4 ft. Custom lengths are available, call Switchcraft® for details.



### Front Access

The Front Access option offers a slide-out tray, allowing the end user to re-terminate the patchbay from the front of the rack.

DIMENSIONS ARE FOR REFERENCE ONLY

Inch  
(mm)

**Switchcraft®**  
www.switchcraft.com

5555 North Elston Avenue / Chicago, IL 60630  
Phone: 773-792-2700 / Fax: 773-792-2129

# PATCHBAYS

## 12 RS 422 Data Patchbay Series



Our standard RS data jackfield series offer a multiple combination of ports, rack heights, and back panel terminations which will easily fit into any television broadcast or video production where custom data patching is required. Custom ports and rack height combinations can be supplied. Contact the factory for details.

### Ordering Information

| Part Number* | No. of Jacks | Front Panel Layout | Back Plane  | Rack Height |
|--------------|--------------|--------------------|-------------|-------------|
| RS422H4N081  | 2 x 8        | Horizontal         | 9 Pin D-Sub | 1           |
| RS422V4N081  | 2 x 8        | Vertical           | 9 Pin D-Sub | 1           |
| RS422H4N161  | 2 x 16       | Horizontal         | 9 Pin D-Sub | 1           |
| RS422H4N162  | 2 x 16       | Horizontal         | 9 Pin D-Sub | 2           |
| RS422V4N161  | 2 x 16       | Vertical           | 9 Pin D-Sub | 1           |
| RS422V4N162  | 2 x 16       | Vertical           | 9 Pin D-Sub | 2           |
| RS422H4N242  | 2 x 24       | Horizontal         | 9 Pin D-Sub | 2           |
| RS422V4N242  | 2 x 24       | Vertical           | 9 Pin D-Sub | 2           |
| RS422V4N322  | 2 x 32       | Vertical           | 9 Pin D-Sub | 2           |

\*Add "N" for non-normalled version

### Features and Benefits

- Unit Features either 8,16, 24, or 32 TT style jacks on the front Panels, to a 9 pin D-Sub.
- All versions utilize low capacitance internal wiring for maximum performance of transferring data
- All standard units are available 1 or 2 rack units high (1.5 RU available by request)
- Rugged, attractive black epoxy finished steel frame chassis

### Specifications

#### Electrical

##### Internal Wiring:

24 AWG Solid TC, foils shield

**Nom Capacitance:** 11.5 pF/ft between conductors

21.3 pF/ft between one conductor and conductor connected to the shield

**Nom. Impedance:** 110 Ohms

# Switche

## RS 422 Data Patchbay Series



RS422V4N32  
32 Vertical Paired Jacks  
Front and Back Views



RS422H4N24  
24 Horizontal Paired Jacks  
Front and Back Views

DIMENSIONS ARE FOR REFERENCE ONLY  $\frac{\text{Inch}}{(\text{mm})}$

### 14 MTP48K Wired Series

#### Features and Benefits

- Unit features 48 MT style jacks in either 1RU (1.75" H) or 2RU (3.5" H) spaces
- All versions utilize AES/EBU wiring for complete digital compatibility
- Attractive, corrosion resistant nickel-plated, steel frame jacks
- Gold-plated switching contacts reduce contact resistance, improve reliability
- Rugged, attractive black epoxy-finished steel chassis
- Extra wide designation strips for easy channel identification
- 1RU version configurations include normals strapped and normals brought out
- 2RU version configurations include normals strapped, normals brought out, and sleeve normals brought out

#### Specifications

##### Materials

##### Jacks

- Frame: Nickel-plated steel
- Bushing: Nickel-plated brass
- Tip, Ring and Shunt Springs: Nickel silver with welded contacts
- Assembly Screws: Zinc-plated steel
- Welded Contacts: Gold alloy

##### Panel

- Front Channel: Black anodized aluminum
- Frame: C.R.S. black epoxy painted
- Designation Strips: Black polycarbonate 94V-0
- Designation Strip Covers: Clear polycarbonate
- Jack Inserts: Thermoplastic polyester



The MTP Series was developed with the AES/EBU digital standard in mind. All versions are made with 110 Ohm cabling inside as a standard. Available in a wide variety of configurations.

##### Mechanical

- Life: 30,000 cycles
- Insertion Force: 7 lbs. maximum
- Withdrawal Force: 1 lb. minimum
- Environmental: 0°C to +50°C

##### Electrical

- Contact Resistance: 30 milliohms maximum initial

- Insulation Resistance: 10,000 megohms maximum
- Dielectric Withstanding Voltage: 500 VAC at 60 Hz
- Working Voltage: 140 VDC maximum
- Current Rating: 100 milliamps

#### Ordering Information

| Part Number | Type of Jack | No. of Jacks | Description                     |
|-------------|--------------|--------------|---------------------------------|
| MTP48K1NS   | MT           | 48           | 1.75" High, normals strapped    |
| MTP48K3NS   | MT           | 48           | 3.5" High, normals strapped     |
| MTP48K1NO   | MT           | 48           | 1.75" High, normals brought out |
| MTP48K3NO   | MT           | 48           | 3.5" High, normals brought out  |
| MTP48K3SNO  | MT           | 48           | 3.5" High, sleeve normals out   |

# PATCHBAYS

## MTP48K Wired Series 15



NORMALS OUT



NORMALS AT JACKS



FULL SLEEVE NORMALS OUT

DIMENSIONS ARE FOR REFERENCE ONLY

$\frac{\text{Inch}}{\text{(mm)}}$

**Switchcraft**  
www.switchcraft.com

5555 North Elston Avenue / Chicago, IL 60630  
Phone: 773-792-2700 / Fax: 773-792-2129



## 16 TTPW96K Wired Series

### Features and Benefits

- Unit features 96 TT style jacks in 2RU (3.5"H) space
- Utilizes AES/EBU wiring for complete digital compatibility
- Attractive, corrosion resistant nickel-plated, steel frame jacks
- Gold-plated switching contacts reduce contact resistance, improve reliability
- Rugged, attractive black epoxy-finished steel chassis
- Extra wide designation strips for easy channel identification

### Specifications

#### Materials

##### Jacks

- Frame: Nickel-plated steel
- Bushing: Nickel-plated brass
- Tip, Ring and Shunt Springs: Nickel silver with welded contacts
- Assembly Screws: Zinc-plated steel
- Welded Contacts: Gold alloy

##### Panel

- Front Channel: Black anodized aluminum
- Frame: C.R.S. black epoxy painted
- Designation Strips: Black polycarbonate 94V-0
- Designation Strip Covers: Clear polycarbonate
- Jack Inserts: Thermoplastic polyester

##### Mechanical

- Life: 30,000 cycles
- Insertion Force: 7 lbs. maximum
- Withdrawal Force: 1 lb. minimum
- Environmental: 0°C to +50°C



The TTPW96K Series was developed with the AES/EBU digital standard in mind. As a standard, the TTPW96K utilizes 110 Ohm cabling inside.

#### Electrical

- Contact Resistance: 30 milliohms maximum initial
- Insulation Resistance: 10,000 megohms maximum
- Dielectric Withstanding Voltage: 500 VAC at 60 Hz
- Working Voltage: 140 VDC maximum
- Current Rating: 100 milliamps

#### Ordering Information

| Part Number | Type of Jack | No. of Jacks | Description                  |
|-------------|--------------|--------------|------------------------------|
| TTPW96K1NN  | TT           | 96           | 1.75" High, non-normals      |
| TTPW96K1HN  | TT           | 96           | 1.75" High, half normals     |
| TTPW96K1NS  | TT           | 96           | 1.75" High, normals strapped |
| TTPW96K3NN  | TT           | 96           | 3.5" High, non-normals       |
| TTPW96K3HN  | TT           | 96           | 3.5" High, half normals      |
| TTPW96K3NS  | TT           | 96           | 3.5" High, normals strapped  |

# PATCHBAYS

## TTPW96K Wired Series 17

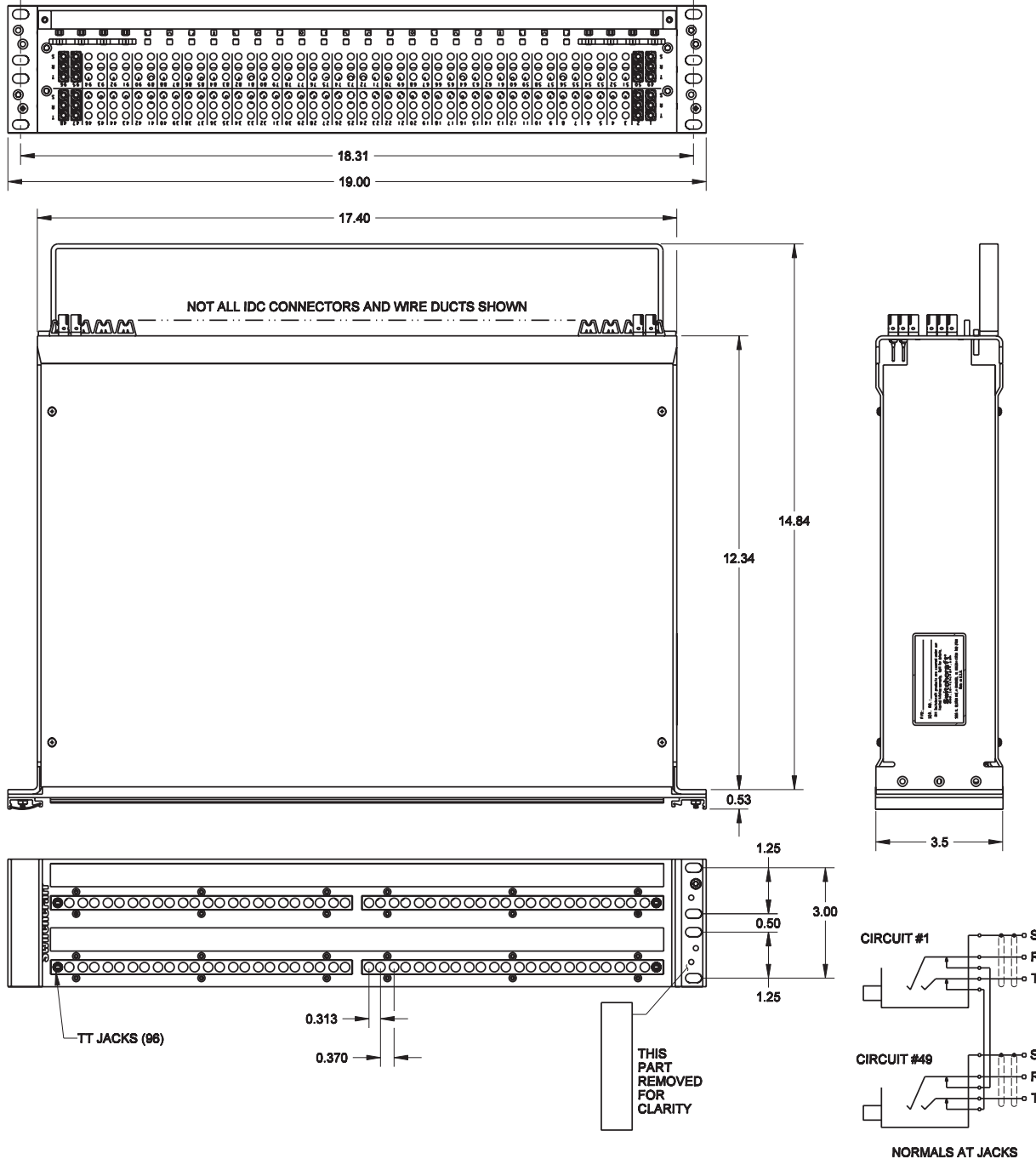

DIMENSIONS ARE FOR REFERENCE ONLY

Inch  
(mm)

**Switchcraft**  
www.switchcraft.com

5555 North Elston Avenue / Chicago, IL 60630  
Phone: 773-792-2700 / Fax: 773-792-2129



# PATCHBAYS

## 18 MTPBP/TTPBP Backpanel Series

### Features and Benefits

- Allows for custom patchbay configurations or central patching points
- PPTs have IDCs on both sides for easy installation
- Rugged, attractive black epoxy-finished steel chassis
- Cable trays allow for mounting and securing terminated cable

### Specifications

Panel thickness: .093"  
 Mounting hole diameter: .187"  
 Mounting hole spacing (48 IDCs/row): .340" (Horizontal) x .275" (Vertical)  
 Mounting hole spacing (52 IDCs/row): .320" (Horizontal) x .275" (Vertical)  
 Wire size: #22, 24, 26 AWG  
 Stranded or Solid (IDC termination)

### Materials

Housing: Thermoplastic (UL 94V-0)  
 Contacts: High strength copper alloy  
 Backpanels: Black Epoxy coated C.R.S.  
 Cable Tray: Black Epoxy coated C.R.S.



The Backpanel Series offers the end user the flexibility of configuring their own patchbay, or to use as a central patchpoint location. The backpanels utilize the PPT punchdown and come with a rugged cable tray.

### Ordering Information

| Part Number | Sets of PPT Terminals | Height | Description     |
|-------------|-----------------------|--------|-----------------|
| MTP48K3BPNS | 48                    | 3.5"   | T, R, S         |
| MTP48K3PBNO | 48                    | 3.5"   | T, R, S, TN, RN |
| MTP52K3BPNO | 52                    | 3.5"   | T, R, S, TN, RN |
| MTP24K7     | 24 x 2                | 7.0"   | +, -, S         |
| TTP96K3BPNS | 96                    | 3.5"   | T, R, S         |
| TTP96K5BPNS | 96 x 2                | 5.25"  | T, R, S, TN, RN |



DIMENSIONS ARE FOR REFERENCE ONLY

Inch  
(mm)

**Switchcraft**<sup>®</sup>  
www.switchcraft.com

5555 North Elston Avenue / Chicago, IL 60630  
Phone: 773-792-2700 / Fax: 773-792-2129

# PATCHBAYS

## 20 TT96 EDAC Series

### Features and Benefits

- Attractive, corrosion-resistant, nickel-plated jacks
- Steel frame jacks for superior jack life
- Extra wide labeling strips provide maximum space and two vertical strips, one at each side
- Rugged, attractive black anodized aluminum face will not break
- Two configurations available:
  - Normals brought out
  - Normaled at jacks
- Gold switching contacts for long-term reliability
- Jacks paired for easy identification of left and right channels
- Connectorized by EDAC® connectors for ease of termination by customer

### Specifications

#### Materials

##### Jacks

Frame: Nickel-plated steel  
 Bushing: Nickel-plated brass  
 Tip, Ring and Shunt Springs: Nickel silver with welded contacts  
 Assembly Screws: Zinc-plated steel  
 Welded Contacts: Gold alloy

##### Panel

Front Channel: Black anodized aluminum  
 Frame & Cover: C.R.S. black epoxy painted  
 Designation Strips: Black polycarbonate 94V-0  
 Designation Strip Covers: Clear polycarbonate  
 Jack Inserts: Polyester

#### EDAC Connector

Housing: Thermoplastic, UL94V-0  
 Contacts: Gold plated phosphor bronze

#### Mechanical

Life: 30,000 cycles  
 Insertion Force: 7 lbs. maximum  
 Withdrawal Force: 1 lb. minimum  
 Operating: -20°C to +65°C



The TT96EDAC Series offers the convenience of EDAC® connectors on the back of the panel for easy installation. Available in normals strapped and normals brought out, both wired to the SAC code of wiring. We also offer custom wiring configurations. Contact the factory for details.

#### Electrical

Contact Resistance: 30 milliohms maximum initial  
 Insulation Resistance: 10,000 megohms  
 Dielectric Withstanding Voltage: 500VAC at 60 Hz  
 Working Voltage: 140VDC  
 Current Rating: 100 milliamps

#### EDAC Mating Plugs

| Part Number     | Description           |
|-----------------|-----------------------|
| 516-090-000-301 | 90 Pin male w/ screw  |
| 516-090-000-302 | 90 Pin male w/ nut    |
| 516-120-000-101 | 120 Pin male w/ screw |
| 516-120-000-102 | 120 Pin male w/ nut   |
| 516-290-500     | Terminal solder-style |
| 516-290-590     | Terminal crimp-style  |

#### Ordering Information

| Part Number | Type of Jack | No. of Jacks | Description                        |
|-------------|--------------|--------------|------------------------------------|
| TT96EDACNO  | TT           | 96           | Normals Brought Out (120 pin EDAC) |
| TT96EDACNS  | TT           | 96           | Normals Strapped (90 pin EDAC)     |

# Switel

# PATCHBAYS

## TT96 EDAC Series



Standard Audio Configuration Wiring (S.A.C.)  
90 Pin Plug Connector  
(Normals at jacks)

| 90 PIN CONNECTOR PIN-OUT                              |     |      |        |
|---|-----|------|--------|
| JACK No.  | TIP | RING | SLEEVE |
| 1   | A   | H    | R      |
| JACKS #2 THRU #6<br>PATTERN CONTINUES TO F, N, W      |     |      |        |
| 7   | X   | AE   | AM     |
| JACKS #8 THRU #12<br>PATTERN CONTINUES TO AC, AL, AT  |     |      |        |
| 13  | BJ  | BS   | BY     |
| JACKS #14 THRU #18<br>PATTERN CONTINUES TO BP, BX, CD |     |      |        |
| 19  | CF  | CN   | CW     |
| JACKS #20 THRU #24<br>PATTERN CONTINUES TO CM, CU, DV |     |      |        |

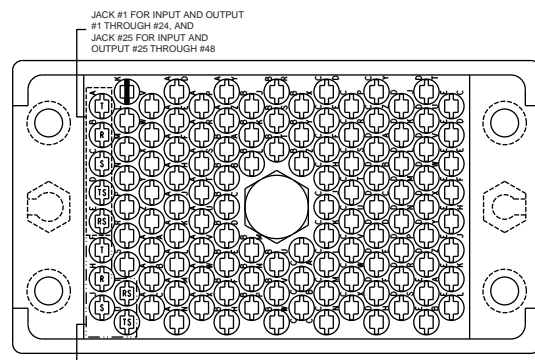

Standard Audio Configuration Wiring (S.A.C.)  
120 Pin Plug Connector  
(Normals brought out)

| 120 PIN CONNECTOR PIN-OUT                                     |     |      |        |           |            |
|---|-----|------|--------|-----------|------------|
| JACK No.  | TIP | RING | SLEEVE | TIP SHUNT | RING SHUNT |
| 1   | A   | B    | C      | D         | E          |
| JACKS #2 THRU #6<br>PATTERN CONTINUES TO AN, AM, AL, AK, AJ   |     |      |        |           |            |
| 7   | AH  | AF   | AE     | AD        | AP         |
| JACKS #8 THRU #12<br>PATTERN CONTINUES TO BN, BP, BW, BU      |     |      |        |           |            |
| 13  | BT  | BS   | BR     | BX        | BY         |
| JACKS #14 THRU #18<br>PATTERN CONTINUES TO CX, DH, DF, DE, DD |     |      |        |           |            |
| 19  | DC  | DB   | DA     | CZ        | CY         |
| JACKS #20 THRU #24<br>PATTERN CONTINUES TO EF, EH, EJ, EK, EL |     |      |        |           |            |

DIMENSIONS ARE FOR REFERENCE ONLY

Inch  
(mm)

# PATCHBAYS

## 22 TTP96K Patchkit Series

### Features and Benefits

- Kit features 96 TT jacks in one rack space (1.75" high) or two rack spaces (3.5" high)
- Jack blocks can be removed from the front for easy soldering
- Dust tray limits dirt, dust and contamination of jack terminals
- Wire management straps are adjustable and reusable
- Attractive, corrosion resistant nickel-plated jacks
- Steel frame jack for superior jack life
- Extra wide labeling strips provide maximum space
- Rugged, attractive black anodized aluminum face will not break or rust
- Three jack configurations available for the exact switching arrangement you need: full normal, half normal, and non-normal (open circuit)
- Fanned solder terminals for easier solder connections
- Gold switching contacts for long-term reliability in normal-through connections

### Specifications

#### Materials

##### Jacks

Frame: Nickel-plated steel  
 Bushing: Nickel-plated brass  
 Tip, Ring and Shunt Springs:  
 Nickel silver with welded contacts

Assembly Screws: Nickel-plated steel

Welded Contacts: Gold alloy

##### Panel

Front Channel: Black anodized aluminum  
 Frame: C.R.S. black epoxy painted  
 Designation Strips: Black polycarbonate 94V-0  
 Designation Strip Covers: Clear polycarbonate  
 Jack Inserts: Thermoplastic polyester



The TTP96K Patchkit Series offers the end user a rugged cable tray to support rear cabling. Heavy duty construction takes weight off the back of the jacks for increased reliability. Available in 1.75" or 3.5" height versions.

#### Mechanical

Life: 30,000 cycles  
 Insertion Force: 7 lbs. maximum  
 Withdrawal Force: 1 lb. minimum  
 Environmental: 0°C to +50°C

#### Electrical

Contact Resistance: 30 milliohms maximum initial  
 Insulation Resistance:  
 10,000 megohms maximum  
 Dielectric Withstanding Voltage:  
 500VAC at 60 Hz  
 Working Voltage: 140VDC maximum  
 Current Rating: 100 milliamps

#### Ordering Information

| Part Number | Type of Jack | No. of Jacks | Description              |
|-------------|--------------|--------------|--------------------------|
| TTP96K1FN   | TT           | 96           | 1.75" High, full normals |
| TTP96K1HN   | TT           | 96           | 1.75" High, half normal  |
| TTP96K1NN   | TT           | 96           | 1.75" High, no normals   |
| TTP96K3FN   | TT           | 96           | 3.5" High, full normals  |
| TTP96K3HN   | TT           | 96           | 3.5" High, half normals  |
| TTP96K3NN   | TT           | 96           | 3.5" High, no normals    |

# Switchtel



**FULL NORMAL**  
TTP96K1FN  
TTP96K3FN

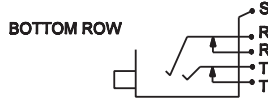

**HALF NORMAL**  
TTP96K1HN  
TTP96K3HN



**OPEN CIRCUIT**  
TTP96K1NN  
TTP96K3NN

DIMENSIONS ARE FOR REFERENCE ONLY

Inch  
(mm)



# PATCHBAYS

## 24 MT48K/MT52K Patchkit Series

### Features and Benefits

- Kit features 48 1/4" longframe jacks in one rack space (1" high) or in two rack spaces (3" high) or 52 1/4" longframe jacks in one rack space (1" high)
- Allows user to add cable and termination panel
- Removable jack panel from the front allows easy soldering of wire connections
- Jacks have gold switching contacts
- Fanned solder terminals for easier soldering
- Offset ground lugs allow easy bussing of ground with one wire
- Jacks have a nickel-plated frame and assembly screws
- Wire management straps are reusable and adjustable



The MT48/52K Patchkit Series offers the end user a rugged cable tray to support rear cabling. Heavy duty construction takes weight off the back of the jacks for increased reliability. Available in 1.75" or 3.5" height versions.

### Specifications

#### Materials

##### Jacks

Frame: Stamped nickel-plated steel

Bushing: Nickel-plated brass

Tip, Ring and Shunt Springs:

Nickel silver with welded contacts

Assembly Screws: Nickel-plated steel

Welded Contacts: Gold alloy

##### Panel

Front Panel: Thermoplastic

Frame: C.R.S. black epoxy paint

Designation Strips: Black polycarbonate 94V-0

Designation Strip Covers: Clear polycarbonate

##### Mechanical

Life: 30,000 cycles

Insertion Force: 7 lbs. maximum

Withdrawal Force: 1 lb. minimum

Operating: 0°C to +50°C

#### Electrical

Contact Resistance: 30 milliohms maximum initial

Insulation Resistance: 10,000 megohms maximum

Dielectric Withstanding Voltage: 500VAC at 60 Hz

Working Voltage: 140VDC maximum

Current Rating: 100 milliamps

#### Ordering Information

| Part Number | Type of Jack | No. of Jacks | Height | Description      |
|-------------|--------------|--------------|--------|------------------|
| MT48K1NS    | MT           | 48           | 1.75"  | Normals strapped |
| MT48K1FN    | MT           | 48           | 1.75"  | Full normals     |
| MT48K1HN    | MT           | 48           | 1.75"  | Half normals     |
| MT48K1NN    | MT           | 48           | 1.75"  | No normals       |
| MT52K1NS    | MT           | 52           | 1.75"  | Normals strapped |
| MT52K1FN    | MT           | 52           | 1.75"  | Full normals     |
| MT52K1HN    | MT           | 52           | 1.75"  | Half normals     |
| MT52K1NN    | MT           | 52           | 1.75"  | No normals       |
| MT48K3FN    | MT           | 48           | 3.5"   | Full normals     |
| MT48K3HN    | MT           | 48           | 3.5"   | Half normals     |
| MT48K3NN    | MT           | 48           | 3.5"   | No normals       |
| MT52K3FN    | MT           | 52           | 3.5"   | Full normals     |
| MT52K3HN    | MT           | 52           | 3.5"   | Half normals     |
| MT52K3NN    | MT           | 52           | 3.5"   | No normals       |

# Switel



MT52K3 SERIES

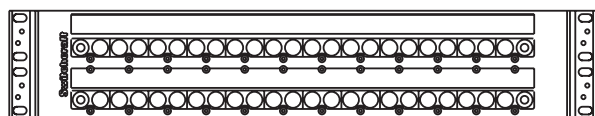

MT48K3 SERIES



MT52K1 SERIES

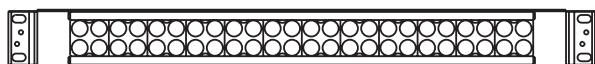

MT48K1 SERIES

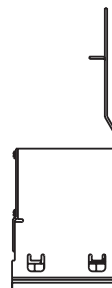

TOP ROW



HALF NORMAL

TOP ROW



NO NORMALS

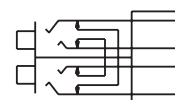

NORMALS STRAPPED  
(K1 SERIES ONLY)

TOP ROW

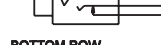

BOTTOM ROW

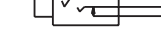

FULL NORMAL



DIMENSIONS ARE FOR REFERENCE ONLY

Inch  
(mm)

**Switchcraft**  
www.switchcraft.com

5555 North Elston Avenue / Chicago, IL 60630  
Phone: 773-792-2700 / Fax: 773-792-2129

# PATCHBAYS

## 26 MT48/MT52 Patchbay Series

### Features and Benefits

- Units feature either 48 or 52 MT Jax®
- Steel frame jacks for superior jack life
- Attractive, corrosion resistant nickel-plated jacks
- Gold switching contacts for long-term reliability in normal-through connections
- Offset ground terminal for ease in making common ground buss connections
- Fanned solder terminals for easier solder connections
- Cable tie bar takes the weight of cables off the jacks
- Four jack configurations available for the exact switching arrangement: full normal, half normal, non-normal, and normals strapped



The MT48/52 Series patchbays offer a rugged cable tie bar to support rear cabling. Also available is the normals strapped configuration which has the shunts or normals tied together, top to bottom jacks.

### Specifications

#### Materials

##### Jacks

- Frame: Steel, nickel-plated
- Bushing: Brass, nickel-plated
- Springs: Nickel silver, solder lugs
- Ground Terminal: Nickel silver, solder lugs
- Switching Contacts: Welded, gold alloy
- Insulation: Phenolic spacers, rigid PVC tubing through stack
- Screws: Steel, nickel-plated

##### Panel

- Jack Panel: Thermoplastic
- Cable Support Bracket: 5/16" diameter black epoxy painted steel rod
- Screws (designation strip): Steel, black zinc-plated
- Screws (mounting jack): Steel, nickel plated
- Kwik-change® Designation Strip: Extruded aluminum, black anodized
- Marking Strip: White plastic, matte finish
- Marking Strip Cover: Clear, extruded plastic

#### Mechanical

- Life: 30,000 cycles
- Insertion Force: 7 lbs. maximum
- Withdrawal Force: 1 lb. minimum
- Operating: 0°C to +50°C

#### Electrical

- Contact Resistance: 30 milliohms maximum initial
- Insulation Resistance: 10,000 megohms maximum
- Dielectric Withstanding Voltage: 500VAC at 60 Hz
- Working Voltage: 140VDC maximum
- Current Rating: 100 milliamps

#### Ordering Information

| Part Number | Type of Jack | No. of Jacks | Description      |
|-------------|--------------|--------------|------------------|
| MT48FN      | MT           | 48           | Full normals     |
| MT48HN      | MT           | 48           | Half normals     |
| MT48NN      | MT           | 48           | No normals       |
| MT48NS      | MT           | 48           | Normals strapped |
| MT52FN      | MT           | 52           | Full normals     |
| MT52HN      | MT           | 52           | Half normals     |
| MT52NN      | MT           | 52           | No normals       |
| MT52NS      | MT           | 52           | Normals strapped |

# Switche

## MT48/MT52 Patchbay Series 27



YMT332BN



YMT334BN



YMT389N

**JACK SCHEMATICS**  
"N" SUFFIX DENOTES WELDED GOLD CONTACTS  
AND NICKEL-PLATED FRAME

DIMENSIONS ARE FOR REFERENCE ONLY  $\frac{\text{Inch}}{\text{(mm)}}$

# PATCHBAYS

## 28 TTP96AS Patchbay Series

### Features and Benefits

- Unit features 96 TT jacks
- Attractive, corrosion resistant nickel-plated jacks
- Steel frame jack for superior jack life
- Extra wide labeling strips provide maximum space
- Rugged cable tie bar takes the weight of cables off the jacks
- Rugged, attractive black anodized aluminum face will not break
- Three jack configurations available for the exact switching arrangement you need: full normal, half normal, and open circuit panel
- Fanned solder terminals for easier solder connections
- Offset ground terminal for ease in making common ground buss connections
- Gold switching contacts for long-term reliability in normal-through connections

### Specifications

#### Materials

##### Jacks

Frame: Steel, nickel-plated  
 Bushing: Nickel-plated copper alloy  
 Springs: Copper alloy solder lugs  
 Ground Terminal: Steel, tin electrodeposited  
 Switching Contacts: Welded, gold alloy inlay over palladium base  
 Insulation: Rigid plastic spacers, rigid PVC tubing through stack  
 Screws: Steel, plated

##### Panel

Frame: Black anodized aluminum  
 Inserts: Polyester, glass filled, 94V-0  
 Cable Support Bar: Cold rolled steel, nickel-plated  
 Designation Strips: Thermoplastic, 94V-0



The TTP96AS Series of patchbays offer a rugged cable tie bar to support rear cabling.

Designation Strip Covers: Clear thermoplastic, SE-1  
 Marking Strip: Rigid vinylite  
 Jack Mounting Screws: Steel, plated  
 Screws: Steel, black plated

#### Mechanical

Life: 30,000 cycles  
 Insertion Force: 7 lbs. maximum  
 Withdrawal Force: 1 lb. minimum  
 Environmental: 0°C to +50°C

#### Electrical

Contact Resistance: 30 milliohms maximum initial  
 Insulation Resistance: 10,000 megohms maximum  
 Dielectric Withstanding Voltage: 500VAC at 60 Hz  
 Working Voltage: 140VDC maximum  
 Current Rating: 100 milliamps

#### Ordering Information

| Part Number | Type of Jack | No. of Jacks | Description  |
|-------------|--------------|--------------|--------------|
| TTP96ASFN   | TT           | 96           | Full normals |
| TTP96ASHN   | TT           | 96           | Half normals |
| TTP96ASNN   | TT           | 96           | No normals   |

# Switel

# PATCHBAYS

## TTP96AS Patchbay Series 29

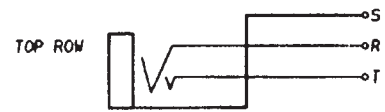

TTP96ASFN

TTP96ASHN

TTP96ASNN

DIMENSIONS ARE FOR REFERENCE ONLY

Inch  
(mm)

**Switchcraft**  
www.switchcraft.com

5555 North Elston Avenue / Chicago, IL 60630  
Phone: 773-792-2700 / Fax: 773-792-2129

# PATCHBAYS

## 30 HPC Patchbay Series

### Features and Benefits

- Available in 1RU or 2RU versions
- Available with or without connectors
- HPC Series connectors are compatible with Neutrik Speakon® connectors
- Cable tie bar takes weight of the cables off the terminations
- Rugged aluminum channel
- Silk-screen designation area makes it easy to re-label channels

### Panel Materials

Housing: Thermoplastic UL 94V-0 rated  
 Contacts: Silver-plated over copper alloy  
 Frame: Aluminum, black anodized  
 Cable Tie Bar: Steel, black epoxy

### HP Connector Specifications

#### Mechanical

Shock: Per Mil-Std 202, Method 213B, Cond. K  
 Vibration: Mil-Std 202, Method 201A  
 Life: 1,000 rotational cycles  
 Cable Range (cord mount): 10AWG, 0.560" cable OD maximum

#### Electrical

Voltage Rating: 1,500 AC RMS, per Mil-Std 202, Method 301  
 Current Rating (Faston® terminals): 50A RMS w/10AWG wire, normal ambient, per UL 1977  
 Current Rating (PC terminals): 30A per UL 1977  
 Contact Resistance: 1mΩ, 1.5mΩ after 1,000 insertion/withdrawals  
 Insulation Resistance: .2TΩ

#### Environmental

Salt Spray: Mil-Std 202, Method 101D, Cond.B  
 Thermal Shock: Mil-Std 202, Method 107G  
 Temperature Limits: -55°C to +85°C  
 Moisture Resistance: Mil-Std 202, Method 106E  
 Life @ Ambient Temperature: Mil-Std 202, Method 108A  
 Touchproof: IEC 65 and 1010-1  
 IP Rating: IEC 529, IP 25

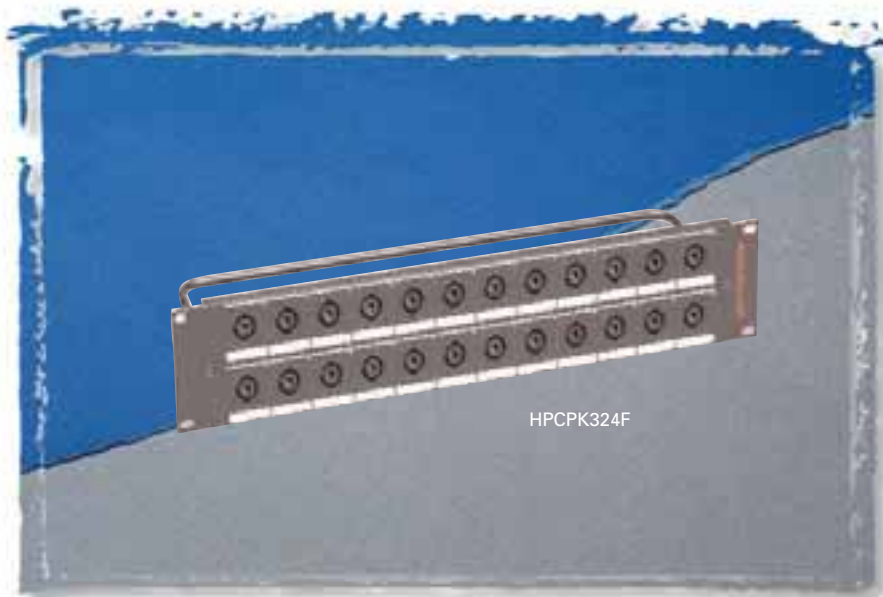

The HPC Patchbay features a 19" rack unit loaded with HPC Series connectors. Available with either 0.250" Faston® terminals or 0.187" Faston® terminals. One rack unit height versions come with 12 HPC connectors, two rack unit height versions come with 24 HPC connectors. All versions have a rugged cable tie bar, which takes the weight of the cabling away from the connections.

#### Materials

Housings: Thermoplastic UL 94V-0 rated  
 Seal Rings: Thermoplastic rubber  
 Contacts: Silver-plated over copper alloy

#### Ordering Information

| Part Number | Height | Description                   |
|-------------|--------|-------------------------------|
| HPCPK112F   | 1.75"  | 12 connectors, 0.250" Fastons |
| HPCPK112F1  | 1.75"  | 12 connectors, 0.187" Fastons |
| HPCPK1B     | 1.75"  | Blank panel                   |
| HPCPK324F   | 3.50"  | 24 connectors, 0.250" Fastons |
| HPCPK324F1  | 3.50"  | 24 connectors, 0.187" Fastons |
| HPCPK3B     | 3.50"  | Blank panel                   |

# Switchtel

# PATCHBAYS

## HPC Patchbay Series 31



DIMENSIONS ARE FOR REFERENCE ONLY

Inch  
(mm)

**Switchcraft**  
www.switchcraft.com

5555 North Elston Avenue / Chicago, IL 60630  
Phone: 773-792-2700 / Fax: 773-792-2129



# PATCHBAYS

## 32 Q-G® Patchbay Series

### Features and Benefits

- Available in 1RU or 2RU versions
- Available with or without the connectors
- E Series connectors are silver-plated, 3 pins/contacts with black finish
- Cable tie bar takes the weight of the cables off the solder terminations
- Rugged aluminum channel increases durability
- Silk-screen designation area makes it easy to re-label channels

### Specifications

#### Materials

##### Connectors

Housing: Die-cast, black velvet finish  
 Inserts: Glass-filled thermoplastic  
 Pin/Contacts: Copper alloy, silver-plated  
 Latch Release: Steel, nickel-plated  
 Insert Locking Cam: Die-cast zinc

##### Frame

Aluminum, black anodized

##### Cable Tie Bar

Steel, black epoxy



The QG® Patchbay features a 19" rack unit loaded with E Series QG® connectors. These XLR's have the same panel cut-out, male or female, silver-plated pins or contacts, and a black finish. All connectors have solder cup terminals for easy soldering and the inserts are removable from the back, allowing for easy changes. The one rack unit height version comes with 16 male, or 16 female, or 8 male and 8 female connectors. The two rack unit version comes with 16 male and 16 female connectors. We also offer the unit without connectors, but with the panel cut-outs already punched out.

All versions have a rugged cable tie bar, which takes the weight of the cabling away from the solder connections.

### Ordering Information

| Part Number | Height | Description                       |
|-------------|--------|-----------------------------------|
| QGPK116FB   | 1.75"  | 16 female                         |
| QGPK116MB   | 1.75"  | 16 male                           |
| QGPK18M8FB  | 1.75"  | 8 male, 8 female                  |
| QGPK332MFB  | 3.5"   | 16 female( top), 16 male (bottom) |
| QGPK1B      | 1.75"  | Blank panel                       |
| QGPK3B      | 3.5"   | Blank panel                       |

# Switchtel

# PATCHBAYS

## Q-G® Patchbay Series 33



DIMENSIONS ARE FOR REFERENCE ONLY Inch  
(mm)

# PATCHBAYS

## 34 VPP Video Patchbay Series

### Features and Benefits

- HD Series rated from DC to 3.0 GHz
- SD Series has a bandwidth from DC to 1.75GHz
- Black thermoplastic modules insulate jacks from chassis
- Jacks feature rugged heavy duty housings

### Video Jack Specifications

#### Electrical

Rated Bandwidth: 3.0 GHz (HD),  
1.75 GHz (SD)  
Characteristic Impedance:  
75 ohms  
Return Loss: Better than -15 dB  
Insertion Loss: Better than -.5 dB  
Contact Resistance: Less than 20 milliohms  
Termination Resistance:  
75 W, ±1%  
Center Conductor: Accepts .090 pin diameter

#### Mechanical

Mechanical Shock: Per MIL-STD-202, Method 213, Test condition I  
Vibration: Per MIL-STD-202, Method 201  
Life Cycle: 30,000

#### Materials

Housing: Zinc alloy, nickel plated  
Center Contacts: Copper alloy, gold plated  
Switching Springs: Copper alloy, gold plated  
Grounding Contacts:  
HD Series - Copper alloy, gold plated  
SD Series - Copper alloy, nickel plated  
Insulators: Thermoplastic, UL 94V-0 rated

#### Environmental

Operating Temperature:  
- 40°C to 65°C  
Storage Temperature:  
- 55°C to 85°C  
Thermal Shock:  
Per MIL-STD-202, Method 107  
Moisture and Humidity:  
Per MIL-STD-202, Method 106

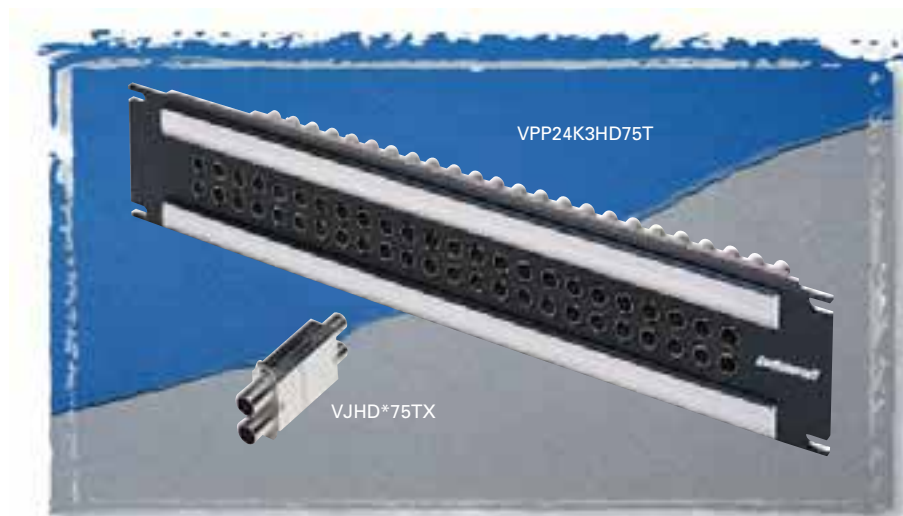

The VPP Series video patchbays offer a wide variety of options for video patching. The HD Series meets SMPTE 292M specifications for high definition video signaling, covering a bandwidth range from DC to 3.0GHz. The SD Series is perfect for serial digital, with a bandwidth from DC to 1.75GHz. Both come in either terminated or non-terminated, 24 or 26 jacks, 1.75" or 3.5" heights.

### Ordering Information

| Part Number   | Type of Jack | No. of Jacks | Height | Description |
|---------------|--------------|--------------|--------|-------------|
| VPP24K1HD*75T | HD           | 24           | 1.75"  | Terminated  |
| VPP24K1HD*NT  | HD           | 24           | 1.75"  | Non-term    |
| VPP24K1SD*75T | SD           | 24           | 1.75"  | Terminated  |
| VPP24K1SD*NT  | SD           | 24           | 1.75"  | Non-term    |
| VPP26K1HD*75T | HD           | 26           | 1.75"  | Terminated  |
| VPP26K1HD*NT  | HD           | 26           | 1.75"  | Non-term    |
| VPP26K1SD*75T | SD           | 26           | 1.75"  | Terminated  |
| VPP26K1SD*NT  | SD           | 26           | 1.75"  | Non-term    |
| VPP24K3HD*75T | HD           | 24           | 3.5"   | Terminated  |
| VPP24K3HD*NT  | HD           | 24           | 3.5"   | Non-term    |
| VPP24K3SD*75T | SD           | 24           | 3.5"   | Terminated  |
| VPP24K3SD*NT  | SD           | 24           | 3.5"   | Non-term    |
| VPP26K3HD*75T | HD           | 26           | 3.5"   | Terminated  |
| VPP26K3HD*NT  | HD           | 26           | 3.5"   | Non-term    |
| VPP26K3SD*75T | SD           | 26           | 3.5"   | Terminated  |
| VPP26K3SD*NT  | SD           | 26           | 3.5"   | Non-term    |

\* Add "N" for non-normalled version

See Page 36 for Individual Jacks Ordering Information

# Switel

## VPP Video Patchbay Series 35



NON-NORMALLED  
TERMINATED



NORMALLED  
TERMINATED



NORMALLED  
NON-TERMINATED



NON-NORMALLED  
NON-TERMINATED

DIMENSIONS ARE FOR REFERENCE ONLY  $\frac{\text{Inch}}{\text{(mm)}}$

# PATCHBAYS

## 36 VPP Video Patchbay Series

### Ordering - Individual Jacks

| Part Number | Type | Description    |
|-------------|------|----------------|
| VJHD*75TX   | HD   | Terminated     |
| VJHD*NTX    | HD   | Non-terminated |
| VJSD*75TX   | SD   | Terminated     |
| VJSD*NTX    | SD   | Non-terminated |

\* Add "N" for non-normalled version

SMITH CHART (TYPICAL)



RETURN LOSS (TYPICAL)



INSERTION LOSS (TYPICAL)



## MVP Midsize Video Patchbay Series

### Features and Benefits

- Midsize video jacks rated from DC to 3 GHz
- 32 midsize jacks mounted either 1RU, 1.5RU or 2RU panel
- Available in terminated or non-terminated configurations

### Specifications

#### Materials

Frame: Aluminum, black anodized  
 Designation Strips: Vinylite, white  
 Designation Strip Covers: Lexan, transparent  
 Jack Inserts: Thermoplastic, UL 94V-0 rated

### Midsize Video Jack Specifications

#### Electrical

Rated Bandwidth: 3.0 GHz  
 Characteristic Impedance: 75 ohms  
 Return Loss: See Typical Return Loss Chart  
 Insertion Loss: See Typical Insertion Loss Chart  
 Contact Resistance: Less than 20 milliohms  
 Termination Resistance: 75 W, ±1%  
 Center Conductor: Accepts .048 pin diameter

#### Mechanical

Mechanical Shock: Per MIL-STD-202, Method 213, Test condition I  
 Vibration: Per MIL-STD-202, Method 201  
 Life Cycle: 30,000

#### Materials

Housing: Zinc alloy, nickel plated  
 Center Contacts: Copper alloy, gold plated



The MVP Series video patchbays offer outstanding performance and high density. Patchbays consist of 32 jacks in either 1RU or 2RU heights, jacks come either terminated or non-terminated. These jacks are rated from DC to 3 GHz, and are rated at 30,000 lifecycles. The 1.5RU and 2RU come with cable tie bars.

#### Environmental

Switching Springs: Copper alloy, gold plated  
 Grounding Contacts: Copper alloy, gold plated  
 BNC Insulators: Teflon  
 Actuators: Thermoplastic, UL94V-0 rated

Operating Temperature: -40°C to 65°C  
 Storage Temperature: -55°C to 85°C  
 Thermal Shock: Per MIL-STD-202, Method 107  
 Moisture and Humidity: Per MIL-STD-202, Method 106

### Ordering Information

| Part Number | Type of Jack | Height | Description    |
|-------------|--------------|--------|----------------|
| MVP32K1*75T | Midsize      | 1.75"  | Terminated     |
| MVP32K1*NT  | Midsize      | 1.75"  | Non-terminated |
| MVP32K2*75T | Midsize      | 2.62"  | Terminated     |
| MVP32K2*NT  | Midsize      | 2.62"  | Non-terminated |
| MVP32K3*75T | Midsize      | 3.5"   | Terminated     |
| MVP32K3*NT  | Midsize      | 3.5"   | Non-terminated |

\* Add "N" for non-normalled version

See Page 39 for Individual Midsize Jacks Ordering Information

# PATCHBAYS

## 38 MVP Midsize Video Patchbay Series



DIMENSIONS ARE FOR REFERENCE ONLY Inch  
(mm)

# Switchcraft

## MVP Midsize Video Patchbay Series

### Ordering - Individual Midsize Jacks

| Part Number | Type | Description    |
|-------------|------|----------------|
| MVJ*75T     | HD   | Terminated     |
| MVJ*NT      | HD   | Non-terminated |

\* Add "N" for non-normalled version

SMITH CHART (TYPICAL)

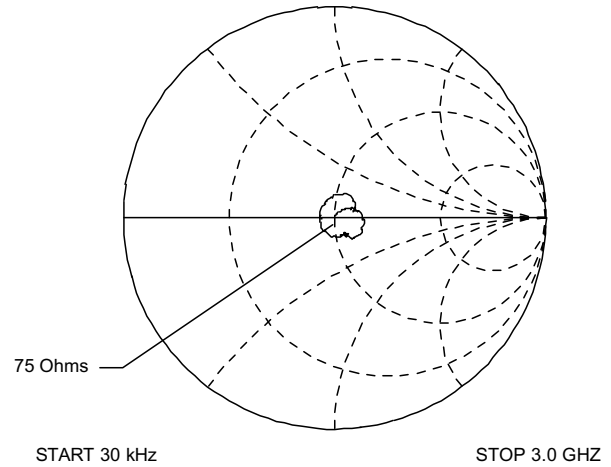

RETURN LOSS (TYPICAL)



INSERTION LOSS (TYPICAL)



DIMENSIONS ARE FOR REFERENCE ONLY

Inch  
(mm)



# PATCHBAYS

## 40 VAP Video/Audio Patchbay Series

### Features and Benefits

- Combines 13 video jacks and 26 long-frame audio jacks into one patchbay
- Available with either HD Series or SD Series video jacks
- All audio jacks are nickel-plated with steel frames and gold-plated switching contacts
- Audio modules consist of 4 YMT334BN jacks, video modules consist of 2 dual video jacks

### Video Jack Specifications

#### Electrical

Rated Bandwidth: 2.4 GHz (HD),  
1.75 GHz (SD)  
Characteristic Impedance: 75 ohms  
Return Loss: Better than -15 dB  
Insertion Loss: Better than -.5 dB  
Contact Resistance: Less than 20 milliohms  
Termination Resistance: 75 W, ±1%  
Center Conductor: Accepts .090 pin diameter

#### Mechanical

Mechanical Shock: Per MIL-STD-202, Method 213, Test condition I  
Vibration: Per MIL-STD-202, Method 201  
Life Cycle: 30,000

#### Materials

Housing: Zinc alloy, nickel plated  
Center Contacts: Copper alloy, gold plated  
Switching Springs: Copper alloy, gold plated  
Grounding Contacts:  
HD Series - Copper alloy, gold plated  
SD Series - Copper alloy, nickel plated  
Insulators: Thermoplastic, UL 94V-0 rated

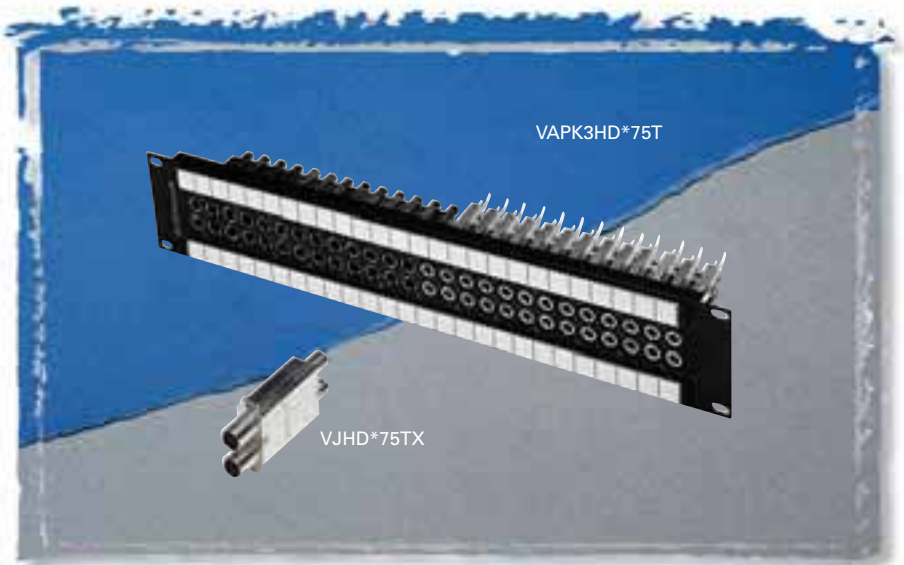

The VAP Series combines audio and video in one convenient patchbay. Standard versions consist of 13 video jacks and 26 long-frame audio jacks into one unit. Options include HD Series video jacks which are rated from DC to 2.4GHz or SD Series rated from DC to 1.5GHz. Both come in either terminated or non-terminated jacks. The MT Style audio jacks all have nickel-plated steel frames and gold-plated switching contacts. Flared terminals make soldering easier. All audio jacks are T,R,S, TN, and RN. Individual modules are useful for custom configurations.

#### Environmental

Operating Temperature: - 40°C to 65°C  
Storage Temperature: - 55°C to 85°C

Thermal Shock: Per MIL-STD-202, Method 107  
Moisture and Humidity: Per MIL-STD-202, Method 106

### Ordering Information

| Part Number | Type of Jack | Height | Description    |
|-------------|--------------|--------|----------------|
| VAPK1HD*75T | HD           | 1.75"  | Terminated     |
| VAPK1HD*NT  | HD           | 1.75"  | Non-terminated |
| VAPK1SD*75T | SD           | 1.75"  | Terminated     |
| VAPK1SD*NT  | SD           | 1.75"  | Non-terminated |
| VAPK3HD*75T | HD           | 3.5"   | Terminated     |
| VAPK3HD*NT  | HD           | 3.5"   | Non-terminated |
| VAPK3SD*75T | SD           | 3.5"   | Terminated     |
| VAPK3SD*NT  | SD           | 3.5"   | Non-terminated |

#### Modules

|           |          |                            |
|-----------|----------|----------------------------|
| VMAFN     | MT Style | 4- YMT334BN jacks          |
| VMVHD*75T | HD       | 2- HD terminated jacks     |
| VMVHD*NT  | HD       | 2- HD non-terminated jacks |
| VMVSD*75T | SD       | 2- SD terminated jacks     |
| VMVSD*NT  | SD       | 2-SD non-terminated jacks  |

\* Add "N" for non-normalled version

See Page 36 For Video Jack Ordering Information and Page 69 For Audio Jack Ordering Information

# Switel

## VAP Video/Audio Patchbay Series 41



DIMENSIONS ARE FOR REFERENCE ONLY

Inch  
(mm)

**Switchcraft**  
www.switchcraft.com

5555 North Elston Avenue / Chicago, IL 60630  
Phone: 773-792-2700 / Fax: 773-792-2129

# PATCHBAYS

## 42 MVEZN Audio/Midsize Patchbay Series

### Features and Benefits

- Combines 16 midsize video jacks and 24 dual EZ Norm bantam jacks.
- Video jacks are rated from DC to 3.0 GHZ.
- Rugged, attractive anodized aluminum frame for increased reliability.
- All audio jacks utilize EZ Norm technology for easy normal reconfiguration. A simple twist of the normal cam changes the normal function from full, to half, to no normals.
- Cable tie bar removes weight off the rear terminations.
- Large designation strips for easy patch point identification.



### Video Jack Specifications

See page 39 for details

### Audio Jack Specifications

See page 10 for details

Part Number: MVEZNP175T

The MVEZN Series combines our popular MVJ midsize video jacks with our latest bantam jack, the EZ Norm. This patchbay has 16 video jacks and 24 dual EZ Norm bantam jacks. Perfect for application where a full video and audio patchbay are unnecessary. The video jacks are rated up to 3.0GHz, and the audio jacks meet 30,000 cycles, both in insertion/withdrawals and with the normal cam.



# Switchtel

## MBPK Video/Audio Patchbay Series 43

### Features and Benefits

- Combines 16 midsize video jacks and 48 TT bantam audio jacks.
- Video jacks are rated from DC to 3.0 GHz.
- All audio jacks are nickel-plated with steel frames and gold-plated cross-bar switching contacts.
- Rugged, attractive anodized aluminum frame for increased reliability.
- Large designation strips for easy patch point identification.
- Audio jacks rated at 30,000 cycles.

### Video Jack Specifications

See page 39 for details

### Audio Jack Specifications

See page 69 for details

### Materials

Frame: Aluminum, black anodized



The MBPK Series combines our popular MVJ midsize video jacks with our standard nickel-plated, steel frame audio jacks. This patchbay combines 16 midsize video jacks with 48 TT bantam audio jacks. Perfect for applications where a full video and audio patchbay are unnecessary. The video jacks are rated up to 3.0GHz, and the audio jacks meet 30,000 cycles. The audio jacks have T, R, S, TN, and RN terminals, and feature gold-plated contacts and flared solder terminals.



DIMENSIONS ARE FOR REFERENCE ONLY

Inch  
(mm)

**Switchcraft**  
www.switchcraft.com

5555 North Elston Avenue / Chicago, IL 60630  
Phone: 773-792-2700 / Fax: 773-792-2129

# PATCHCORDS/MOLDED CABLES

## 44 Audio and Video Patchcords

### Features and Benefits - Audio

- 110 ohm impedance-matched digital patchcords meet AES/EBU interface standards for digital patching
- Available with a variety of plug terminations, plug finishes, cord lengths and cable colors, the patchcords offer design flexibility
- Premium quality cable insures high reliability and greater flexibility



### Specifications

Standard plug terminations are single 3-conductor 1/4" and TT® Nickel-plated plugs (standard), brass and gold-plated (optional) Cable jacket material is PVC. Black is standard with other colors available

### Features and Benefits - Video

- Designed and built to highest quality standards for efficient video signal transmission
- Cable type is RG59 (75W)
- Rugged nickel-plated handles with knurled area for positive finger grip
- Available in standard size or midsize styles

### Specifications

#### Materials

Housing: Nickel-plated, copper alloy  
 Contact Pin: Gold-plated, copper alloy  
 Boot: Thermoplastic, in black and colors

A wide variety of audio patchcords and molded cable assemblies are available. Some of the more popular versions are the 18Q and 20Q Series for professional 1/4" patching, the TT\* and TTD Series for TT or bantam AES/EBU digital patching. The VP and VMP Series offer exceptional performance for video signal patching.



### Ordering Information

#### Video Patchcords

| Part Number | Type     | Part Number | Type    |
|-------------|----------|-------------|---------|
| VP3**       | Standard | VMP2**      | Midsize |
| VP4**       | Standard | VMP3**      | Midsize |
| VP5**       | Standard | VMP4**      | Midsize |
| VP6**       | Standard | VMP5**      | Midsize |
| VP7**       | Standard | VMP6**      | Midsize |
| VP8**       | Standard | VMP7**      | Midsize |
| VP9**       | Standard | VMP8**      | Midsize |
| VP10**      | Standard | VMP9**      | Midsize |
| VSPP        | Standard | VMP10**     | Midsize |
| VMP1**      | Midsize  | VMPP        | Midsize |

When ordering, add the following for cable color: BK-Black, BL-Blue, R-Red, O-Orange, Y-Yellow, GN-Green, P-Purple, GY-Gray

# PATCHCORDS/MOLDED CABLES

## Audio and Video Patchcords

### Ordering Information

| Part Number             | Type          | Plug   | Finger | Description                |
|-------------------------|---------------|--------|--------|----------------------------|
| <b>Audio Patchcords</b> |               |        |        |                            |
| 18QD18                  | 1/4" Mil-Type | Brass  |        | 2 foot, black nylon jacket |
| 18QF18                  | 1/4" Mil-Type | Brass  |        | 3 foot, black nylon jacket |
| 18QH18                  | 1/4" Mil-Type | Brass  |        | 4 foot, black nylon jacket |
| 20QD20N*                | 1/4" Mil-Type | Nickel |        | 2 foot, nylon jacket       |
| 20QF20N*                | 1/4" Mil-Type | Nickel |        | 3 foot, nylon jacket       |
| 20QH20N*                | 1/4" Mil-Type | Nickel |        | 4 foot, nylon jacket       |

When ordering, add the following for cable color: 0-Black, 2-Red, 5-Green, 6-Blue

|       |              |       |  |                            |
|-------|--------------|-------|--|----------------------------|
| TT122 | TT or Bantam | Brass |  | 1 foot, molded gray jacket |
| TT124 | TT or Bantam | Brass |  | 2 foot, molded gray jacket |
| TT126 | TT or Bantam | Brass |  | 3 foot, molded gray jacket |
| TT127 | TT or Bantam | Brass |  | 4 foot, molded gray jacket |
| TT128 | TT or Bantam | Brass |  | 5 foot, molded gray jacket |

### AES/EBU 110 Ohm Digital Single Plug Patchcords

|       |              |        |  |                 |
|-------|--------------|--------|--|-----------------|
| TT1*  | TT or Bantam | Nickel |  | 1 foot, molded  |
| TT2*  | TT or Bantam | Nickel |  | 2 foot, molded  |
| TT3*  | TT or Bantam | Nickel |  | 3 foot, molded  |
| TT4*  | TT or Bantam | Nickel |  | 4 foot, molded  |
| TT5*  | TT or Bantam | Nickel |  | 5 foot, molded  |
| TT6*  | TT or Bantam | Nickel |  | 6 foot, molded  |
| TT7*  | TT or Bantam | Nickel |  | 7 foot, molded  |
| TT8*  | TT or Bantam | Nickel |  | 8 foot, molded  |
| TT9*  | TT or Bantam | Nickel |  | 9 foot, molded  |
| TT10* | TT or Bantam | Nickel |  | 10 foot, molded |

### AES/EBU 110 Ohm Digital, or RS422 Dual Plug Patchcords

|        |              |        |  |                 |
|--------|--------------|--------|--|-----------------|
| TTD1*  | TT or Bantam | Nickel |  | 1 foot, molded  |
| TTD2*  | TT or Bantam | Nickel |  | 2 foot, molded  |
| TTD3*  | TT or Bantam | Nickel |  | 3 foot, molded  |
| TTD4*  | TT or Bantam | Nickel |  | 4 foot, molded  |
| TTD5*  | TT or Bantam | Nickel |  | 5 foot, molded  |
| TTD6*  | TT or Bantam | Nickel |  | 6 foot, molded  |
| TTD7*  | TT or Bantam | Nickel |  | 7 foot, molded  |
| TTD8*  | TT or Bantam | Nickel |  | 8 foot, molded  |
| TTD9*  | TT or Bantam | Nickel |  | 8 foot, molded  |
| TTD10* | TT or Bantam | Nickel |  | 10 foot, molded |

When ordering, add the following for cable color: BK-Black, BL-Blue, R-Red, O-Orange, Y-Yellow, GN-Green, P-Purple, GY-Gray

### Ordering Information

| Part No.                  | Description                      |
|---------------------------|----------------------------------|
| <b>Molded MIDI Cables</b> |                                  |
| MD3                       | 3 foot, 5 pin DIN, molded black  |
| MD6                       | 6 foot, 5 pin DIN, molded black  |
| MD10                      | 10 foot, 5 pin DIN, molded black |
| MD15                      | 15 foot, 5 pin DIN, molded black |

Uses 4 cond., 24 awg, PVC outer jacket, braided shielded cable

### 1/4" Cables

|        |                                  |
|--------|----------------------------------|
| 05AD05 | 2 foot, mono, male to male       |
| 05AK05 | 6 foot, mono, male to male       |
| 05AN05 | 10 foot, mono, male to male      |
| 05AU05 | 25 foot, mono, male to male      |
| 05AN15 | 10 foot, mono, male to RA male   |
| 05AN80 | 10 foot, mono, male to female    |
| 05AU80 | 25 foot, mono, male to female    |
| 10BF10 | 3 foot, stereo, male to male     |
| 10BK10 | 6 foot, stereo, male to male     |
| 10BN10 | 10 foot, stereo, male to male    |
| 15AK15 | 6 foot, mono, RA male to RA male |

### RCA

|        |                             |
|--------|-----------------------------|
| 25AF25 | 3 foot, male to male        |
| 25AK25 | 6 foot, male to male        |
| 25AN25 | 10 foot, male to male       |
| 25AK82 | 6 foot, male to female      |
| 30AK30 | 6 foot, RA male to RA male  |
| 30AN30 | 10 foot, RA male to RA male |
| 30AR30 | 15 foot, RA male to RA male |

### 1/4" to RCA

|        |                                |
|--------|--------------------------------|
| 05AK25 | 6 foot, 1/4" male to RCA male  |
| 05AN25 | 10 foot, 1/4" male to RCA male |

Uses either single or 2 cond, 22awg, PVC outer jacket, braided shielded cable

DIMENSIONS ARE FOR REFERENCE ONLY  $\frac{\text{Inch}}{(\text{mm})}$

**Switchcraft**  
www.switchcraft.com

5555 North Elston Avenue / Chicago, IL 60630  
Phone: 773-792-2700 / Fax: 773-792-2129

# CONNECTORS

## 46 Q-G® Audio Connector Series A, AA, AAA Cord Style Series

Switchcraft offers a wide range of cord style XLR connectors.

The A Series features a dual pressure plate strain relief mechanism to securely fasten the connector to the cable. The A Series is also available with FAS-DISCONNECT detent.

The AA Series features a 1-piece strain relief mechanism that clamps onto the outer jacket of the cable.

The AAA Series features a twist-on handle with a built-in strain relief mechanism and a pre-loaded insert. The new R Series offers the same strain relief system as the AAA Series.

### Specifications

#### Electrical

Contact Resistance: 50 milliohm maximum, per pole

Current Rating @ 125VAC:

3 pole - 15A, 4 pole -10A,

5 & 6 pole - 7.5A, 7 pole - 5A

Insulation Resistance: 1,000 MW, minimum

Dielectric Withstanding Voltage: 1,000 V (rms)

Capacitance: ≤3pF between pins and ≤6 pF between pins and shell, maximum

#### Mechanical

Insertion/Withdrawal Forces:

10 lbs. maximum, 8 lbs. nominal/

7 lbs. maximum, 5 lbs. nominal

#### Materials

Shell: Die-Cast zinc with nickel finish or black chrome

Handle: Die cast with nickel finish or black chrome. Also black thermoplastic handle available

O Ring: TPR (Thermoplastic rubber).

Insert Insulation: Molded thermoplastic

Socket Contacts: Silver plated copper alloy tarnish resistant; bifurcated on 3 and 4 contact types. Gold is available.

Pin Contacts: Silver plated copper alloy.

See Page 56 for Mechanical Drawings



Resists tarnishing, and provides excellent electrical conductivity.

Gold is available.

Latch lock: High strength die cast zinc

Multi-finger cable clamp and rubber

gasket: TPR (Thermoplastic plastic & rubber)

Flex Relief: TPR (Thermoplastic rubber)

### Ordering Information

| Part Number            | Style | Finish | Pins/Contacts | Notes                                    |
|------------------------|-------|--------|---------------|--|
| A*F, A*M               | Cord  | Nickel | Silver        | Standard Cable Clamp                     |
| A*FB, A*MB             | Cord  | Black  | Silver        | Standard Cable Clamp                     |
| A*FBAU, A*MBAU         | Cord  | Black  | Gold          | Standard Cable Clamp                     |
| A*FL, A*ML             | Cord  | Nickel | Silver        | Standard cable clamp, large flex relief  |
| AA*F, AA*M             | Cord  | Nickel | Silver        | One piece cable clamp                    |
| AA*FB, AA*MB           | Cord  | Black  | Silver        | One piece cable clamp                    |
| AA*FBAU, AA*MBAU       | Cord  | Black  | Gold          | One piece cable clamp                    |
| AA*FL, AA*ML           | Cord  | Nickel | Silver        | One piece cable clamp, large flex relief |
| AAA*FZ, AAA*MZ         | Cord  | Nickel | Silver        | Twist-on metal handle                    |
| AAA*FBZ, AAA*MBZ       | Cord  | Black  | Silver        | Twist-on metal handle                    |
| AAA*FBAUZ, AAA*MBAUZ   | Cord  | Black  | Gold          | Twist-on metal handle                    |
| AAA*FPZ, AAA*MPZ       | Cord  | Nickel | Silver        | Twist-on plastic handle                  |
| AAA*FPBZ, AAA*MPBZ     | Cord  | Black  | Silver        | Twist-on plastic handle                  |
| AAA*FPBAUZ, AAA*MPBAUZ | Cord  | Black  | Gold          | Twist-on plastic handle                  |

\* Available 3 - 7 pins or contacts

# Switchcraft

# CONNECTORS

## Q-G® Audio Connector Series B, C, D, E Panel Style Series

47



Switchcraft also offers a wide range of panel mount connectors.

The B Series features a round housing with a threaded collar for mounting. The female version requires a spanner wrench to tighten the connector to the chassis. Both male and female are available with black finish.

The C Series is another round housing panel mount, which has 0.140" mounting holes requiring #5-40 screws to mount.

The D Series, our most popular version, is a rectangle housing panel mount. The standard Rawall finish resists scratching, while the optional satin finish offers a smooth finish for mounting on a brushed finished chassis.

The E Series offers a panel mount with quick release inserts. A small screwdriver is used to remove the inserts, allowing for easy gender changes. The male and female E Series fit into the same panel cut-outs.

The E Series is also available with PC terminals. Contact the factory for details.

### Ordering Information

| Part Number           | Style | Finish | Pins/<br>Contacts | Notes                            |
|-----------------------|-------|--------|-------------------|----------------------------------|
| B*F, B*M              | Panel | Nickel | Silver            | Threaded Collar                  |
| B*FB, B*MB            | Panel | Black  | Silver            | Threaded Collar                  |
| C*F, C*M              | Panel | Nickel | Silver            | Uses #5-40 mounting screws       |
| C*FB, C*MB            | Panel | Black  | Silver            | Uses #5-40 mounting screws       |
| D*F, D*M              | Panel | Nickel | Silver            | Uses #5-40 mounting screws       |
| D*FB, D*MB            | Panel | Black  | Silver            | Rectangle housing                |
| D*FBAU, D*MBAU        | Panel | Black  | Gold              | Rectangle housing                |
| D*FS, D*MS            | Panel | Nickel | Silver            | Rectangle housing, smooth finish |
| E3FSC, E3MSC          | Panel | Nickel | Silver            | Male/Female same panel cut-out   |
| E3FSCB, E3MSCB        | Panel | Black  | Silver            | Male/Female same panel cut-out   |
| E3FSCBAU,<br>E3MSCBAU | Panel | Black  | Gold              | Male/Female same panel cut-out   |

\* Available 3 - 7 pins or contacts

See Page 57 for Mechanical Drawings



# CONNECTORS

48

## Q-G® Audio Connector Series J, K, P, R, T Wallplate, Gooseneck, Panel & Cord Style Series

The J and K Series are wallplates using the D Series receptacles pre-mounted. Available in single or dual connector versions.

The PD Series is a plastic panel mount series, using 94V-0 rated material. Both male and female mount into the same panel cut-out and are available in solder cup, straight PC, and right angle PC terminals.

Switchcraft also offers gooseneck connectors and cord plugs with on-off switches. The P Series are gooseneck connectors available in male or female, with optional black finishes. The male has external 5/8-27 threads, the female has internal 5/8-27 threads.

The new R Series incorporates the same strain relief system as the AAA Series. The insert can be offset at 45° to accommodate a wide variety of applications.

The T Series is similar to the A Series female cord plug, but offers a DPDT (2-C) locking on-off switch. The slide switch is rated at 500mA, 125V.



### Ordering Information

| Part Number          | Style     | Finish | Pins/<br>Contacts | Notes                                    |
|----------------------|-----------|--------|-------------------|--|
| J3FS                 | Wallplate | Nickel | Silver            | Single D3F                               |
| K3FS                 | Wallplate | Nickel | Silver            | Dual D3F's                               |
| P*F, P*M             | Gooseneck | Nickel | Silver            | Female ext. threads,<br>male int.threads |
| P*FB, P*MB           | Gooseneck | Black  | Silver            | Female ext. threads,<br>male int.threads |
| PD3FSC1, PD3MSC1     | Panel     | Black  | Silver            | Plastic Housing                          |
| PD3FSC1AU, PD3MSC1AU | Panel     | Black  | Gold              | Plastic Housing                          |
| R*FZ, R*MZ           | Cord      | Nickel | Silver            | Right Angle                              |
| R*FBZ, R*MBZ         | Cord      | Black  | Silver            | Right Angle                              |
| R*FBAUZ, R*MBAUZ     | Cord      | Black  | Gold              | Right Angle                              |
| T3F                  | Cord      | Nickel | Silver            | On-off switch                            |

\* Available 3 - 7 pins or contacts

See Pages 58 and 59 for Mechanical Drawings

# Switchcraft

# CONNECTORS

## Tini-Q-G® Connector Series Tini-Q-G® Cord & Panel Style Series



The Tini-QG Series is a miniature version of the standard QG Series. These “mini-XLR’s” come in a wide variety of configurations. The standard TA Series cord plugs are available in 3-6 pins or contacts. The L versions, with their larger strain reliefs, are available in 3-8 pins or contacts. The TB and TY Series are panel mount connectors. The TB Series is a male connector, featuring a round panel cut-out and 3-8 pins. The TY Series is a female connector, featuring a rectangular housing and 3-5 contacts. The TA and TB Series are available with a black finish. Gold-plated contacts are available on all series. Contact the factory for details.

### Materials

Housing: Plugs and Male Receptacles — Copper alloy, nickel-plated;  
Female Receptacles — Die-cast zinc, nickel-plated  
Black Tini-Q-G® Housing: Copper alloy, black chrome-plated  
Pin and Socket Contacts: Copper alloy, silver-plated  
Flex Relief: Molded black thermoplastic elastomer  
Latch Button: Molded black thermoplastic

Release Lever and Mounting Washer: Steel, nickel-plated  
Standoff/Ground Terminal and Cable Clamp: Steel, electroplated  
Inserts and Insulating Spacer: Molded, high strength thermoplastic  
Latch (Female): Copper alloy, nickel-plated  
Mounting Nut: Copper alloy, nickel-plated

### Ordering Information

| Part Number  | Style | Finish | Pins/Contacts | Notes   |
|--------------|-------|--------|---------------|---|
| TA*F, TA*M   | Cord  | Nickel | Silver        | Available in 3 - 6 pins or contacts                               |
| TA*FL, TA*ML | Cord  | Nickel | Silver        | Accommodates large cable, available in 3 - 8 pins or contacts     |
| TA*FB, TA*MB | Cord  | Black  | Silver        | Available in 3 - 6 pins or contacts                               |
| TB*M         | Panel | Nickel | Silver        | Male, round flange, threaded, available in 3 - 8 pins or contacts |
| TB*MB        | Panel | Black  | Silver        | Male, round flange, threaded, available in 3 - 8 pins or contacts |
| TY*F         | Panel | Nickel | Silver        | Female, rectangle flange, available in 3 - 5 pins or contacts     |

See Page 59 for Mechanical Drawings

### Specifications

#### Electrical

Contact Resistance: .010 ohms maximum after life (and after salt spray)  
Current Rating (Carry Only): 5A, 125 VAC (4A, 125 VAC on 5 circuit) based on 30°C maximum  
Insulation Resistance: 510,000 megohms minimum @ 500 VDC (initial); 10,000 megohms minimum (after humidity test)  
Dielectric Strength: 1,000V (rms)

#### Mechanical

Life: 5,000 operations minimum  
Solderability Standard: Meets EIA RS-186-9E  
Mechanical Shock: Meets Mil-Std-202, method 213B  
Vibration: Meets Mil-Std-202, method 201A  
Wire Size: #22 wire gauge solid; #24 wire gauge stranded

#### Environmental

Thermal Range: -55°C to +85°C  
Humidity: Meets Mil-Std-202, method 106D  
Thermal Shock: Meets Mil-Std-202, method 107D  
Salt Spray: Meets Mil-Std-202, method 101

# CONNECTORS

## 50 HPC Connector Series HPC Panel Style Series

The HPC Series is a complete line of high power loudspeaker connectors that are completely compatible with the Neutrik® Speakon® 4 pole connector series. Included in the series are round and rectangular panel mounts, straight cord plugs, right angle cord plugs, and in-line cord plug, plus a barrel adapter.

The HPC panel mounts come with two different flange depths, either 0.100" or 0.200" depths. The 0.200" depth allows for easy rear mounting of the connector and maintains proper mating with the cord plug. Also, the panel mounts have two different Faston® terminal sizes, 0.187" and 0.250" wide. Both are rated at 50A, per UL 1977. The PC mount versions have either straight, right angle, or right angle with a mounting post. They are rated at 30A per UL 1977. The right angle PC mount version with the post allows for snap-in placement onto the PC board during wave soldering.

The HPC cord plugs are offered in straight, right angle, and an in-line version. All have 0.250" Faston® terminals, rated at 50A per UL 1977, which makes it easy to swap out plugs. The unique feature of the cord plugs is their "push to lock" design. They do not require a 1/4 turn to engage the contacts – simply push the connector in like an XLR. This feature eliminates the need to remember to turn the connector to make contact with the contacts. To disengage, simply push the latch lever forward and pull the connector out. The straight cord plug uses a twist on handle, while the in-line and right angle cord plugs use a snap-in handle. The in-line connector mates with both straight and right angle cord plugs.

For those who find it more convenient, we also offer a barrel adapter which mates with either straight or right angle cord plugs.



### Ordering Information

| Part Number | Style | Notes  |
|-------------|-------|--|
| HPCP41F     | Panel | Rectangle, 0.100" flange depth, 0.250" faston terms  |
| HPCP42F     | Panel | Rectangle, 0.200" flange depth, 0.250" faston terms  |
| HPCP41F1    | Panel | Rectangle, 0.100" flange depth, 0.187" faston terms  |
| HPCP42F1    | Panel | Rectangle, 0.200" flange depth, 0.187" faston terms  |
| HPCP410PC   | Panel | Rectangle, 0.100" flange depth, straight PC terms    |
| HPCP420PC   | Panel | Rectangle, 0.200" flange depth, straight PC terms    |
| HPCP410RA   | Panel | Rectangle, 0.100" flange depth, right angle PC terms |
| HPCP420RA   | Panel | Rectangle, 0.200" flange depth, right angle PC terms |
| HPCPR41F    | Panel | Round, 0.100" flange depth, 0.250" faston terms      |
| HPCPR42F    | Panel | Round, 0.200" flange depth, 0.250" faston terms      |
| HPCPR41F1   | Panel | Round, 0.100" flange depth, 0.187" faston terms      |
| HPCPR42F1   | Panel | Round, 0.200" flange depth, 0.187" faston terms      |
| HPCPR410PC  | Panel | Round, 0.100" flange depth, straight PC terms        |
| HPCPR420PC  | Panel | Round, 0.200" flange depth, straight PC terms        |

See Pages 61 and 62 for Mechanical Drawings

# CONNECTORS

## HPC Connector Series HPC Cord, & Adapter Style Series

51



### Specifications

#### Mechanical (Panel and Cord Mounts)

Shock: Per Mil-Std 202,  
Method 213B, Cond. K  
Vibration: Mil-Std 202,  
Method 201A  
Life: 1,000 rotational cycles  
Cable Range (cord mount):  
10AWG, 0.560" cable OD  
maximum

#### Electrical (Panel and Cord Mounts)

Voltage Rating: 1,500 AC RMS,  
per Mil-Std 202, Method 301  
Current Rating (Faston® terminals): 50A RMS w/10AWG  
wire, normal ambient, per  
UL 1977  
Current Rating (PC terminals):  
30A per UL 1977  
Contact Resistance: 1mΩ, 1.5mΩ  
after 1,000 insertion/withdrawals  
Insulation Resistance: > 2T Ω

#### Environmental (Panel and Cord Mounts)

Salt Spray: Mil-Std 202, Method  
101D, Cond. B  
Thermal Shock: Mil-Std 202,  
Method 107G  
Temperature Limits:  
-55°C to +85°C  
Moisture Resistance: Mil-Std.  
202, Method 106E  
Life @ Ambient Temperature:  
Mil-Std 202, Method 108A  
Touchproof: IEC 65 and 1010-1  
IP Rating: IEC 529, IP 25

#### Materials (Panel and Cord Mounts)

Housings:  
Thermoplastic UL 94V-0 rated  
Seal Rings: Thermoplastic rubber  
Contacts: Silver-plated over  
copper alloy

### Ordering Information

| Part Number | Style | Notes                                |
|-------------|-------|--------------------------------------|
| HPCC4F      | Cord  | Straight with 0.250" faston terms    |
| HPC14F      | Cord  | Inline with 0.250" faston terms      |
| HPCC4RAF    | Cord  | Right angle with 0.250" faston terms |

See Page 62 for Mechanical Drawings

# CONNECTORS

## 52 EH Series Receptacles

The EH Series consist of different styles of popular connectors in our E Series housing. This allows the end user to punch one single hole size and populate wall plates, gang assemblies with different types of connectors. Connector styles include BNC feed-throughs, RCA feed-throughs, USB feed-throughs, IEEE 1394 Firewire feed-throughs, BNC to solder cup, and RCA to BNC.

### Features

- Utilizes same panel cut-out as E Series QG connectors
- Rugged metal shells
- Available with a wide variety of popular feed-through connectors



### Ordering Information

| Part Number | Description          |
|-------------|----------------------|
| EHBNC2      | BNC to BNC           |
| EHBNCSC     | BNC to solder cup    |
| EHRCA2      | RCA to RCA           |
| EHRCABNC    | RCA to BNC           |
| EHUSB2      | USB to USB           |
| EH13942     | IEEE1394 to IEEE1394 |
| EHCAT62     | Cat6 to Cat6         |

**Note: For black finish add 'B' suffix  
See Page 55 for Mechanical Drawings**

# Switel

# CONNECTORS

## MIDI and 2500 Series 53

The 5-pin DIN connector has been adopted by the audio industry as the standard MIDI (Musical Instrument Digital Interface) connector. Switchcraft offers a wide variety of DIN and mini-DIN connectors, however, only the 5-pin DIN versions are shown in this catalog. The more popular versions used in the audio industry include straight metal, straight plastic, and right angle cord plugs, as well as metal chassis and plastic right angle PC mount versions.

The 2500 Series microphone connectors are still used in many retro-style microphones. Cable mount versions can accommodate cable OD's up to 0.281".

### Specifications

#### Materials

- Shell: Die-cast zinc alloy, nickel plated
- Receptacle Mounting Flange: Steel
- Receptacle Body: Plastic
- Insert Material: Plastic
- Socket Contacts: Tin-plated
- Pin Contacts: Tin-plated
- Switching Contacts: Silver-plated
- Cable Relief Bushing: Soft plastic



### Ordering Information

| Part Number | Style | Notes                                   |
|-------------|-------|---|
| 05BL5M      | Cord  | Male, straight, metal handle            |
| 05GM5M      | Cord  | Male, straight, plastic handle          |
| 05DL5M      | Cord  | Male, right angle, metal handle         |
| 57GB5F      | Panel | Female                                  |
| 57PC5F      | Panel | Female, right angle, PC mount           |
| 57PC5FS     | Panel | Female, right angle, PC mount, shielded |
| 2501F       | Cord  | Female, single contact, locking collar  |
| 2501M       | Cord  | Male, single contact, ext. threads      |
| 2501MP      | Panel | Male, single contact, ext. threads      |

See Page 60 for Mechanical Drawings

# CONNECTORS

54

## HP75BNC Series True 75 Ohm BNC Series

The HP75BNC Series is a true 75 Ohm impedance BNC connector series. All connectors meet stringent guidelines for top performance. The HP75BNC Series is available in a wide variety of cable types. All use standard crimping tools.

### Features and Benefits

- True 75 Ohm impedance
- Rugged nickel-plated, machined housings
- Gold-plated center pins enhance performance

### Specifications

#### Electrical

Contact Resistance: 75 Ohms  
Voltage Rating: 500 Volts RMS  
Return Loss: Less than -25 db at 3 GHz  
Insulation Resistance:  
5000 Megohms minimum

#### Mechanical

Lifecycles: 500 minimum  
Center Contact Retention:  
6 lbs. minimum  
Coupling Mechanism:  
100 lbs. minimum  
Force to Engage:  
2.5 lbs. maximum

#### Environmental

Thermal Range: -65°C to 165°C  
Moisture Resistance: Mil Std 202  
Corrosion: Mil Std 202  
Flammability: UL 94-V0  
Vibration: Mil Std 202  
Solvent Resistance: Mil Std 202

#### Finish

Body/Bayonet: Nickel-plated, copper alloy  
Center Conductor: 50 mi gold-plated copper alloy



### Ordering Information

| Part Number | Crimp Info                       | Cable Type   |
|-------------|----------------------------------|--|
| HP75BNC1    | Pin .041 Hex<br>Ferrule .255     | Belden 8241, 8279, 82241<br>Gepco VJ59U<br>Comm/Scope 5563   |
| HP75BNC2    | Pin .041 Hex<br>Ferrule .324 Hex | Belden 8281, 8281B, 9141, 88281, 9231, 8141, 9118, 9248<br>Gepco VP618PE, VP618PVC, VP6000<br>Comm/Scope 7501, 7506                                |
| HP75BNC7    | Pin .041 Hex<br>Ferrule .278 Hex | Belden 1694A, 1695A, 87120, 89120, 9066, 9114, 9659<br>Gepco VSD2001, VSD2001TS<br>Comm/Scope 5729 ,5765, 2227K, 2227V, 2229V, 2275V, 2276V, 2279V |
| HP75BNC9    | Pin .041 Hex<br>Ferrule .255 Hex | Belden 1505A, 1506A, 8212, 8241F, 9167, 9259,<br>Gepco VPM2000, VPM2000TS, VPM2000TK<br>Comm/Scope 2000, 5553, 5565, 5572                          |
| HP75BNC12   | Pin .041 Hex<br>Ferrule .178 Hex | Belden 1855A, 1865A<br>Gepco VDM230, VDM250, RGB230/250 Series<br>Comm/Scope 7537, 7538  |

See Next Page for  
Mechanical Drawings

# Switel

# CONNECTORS

## Connector Dimension Drawings True 75 Ohm BNC Series, EH Series

### HP75BNC Series

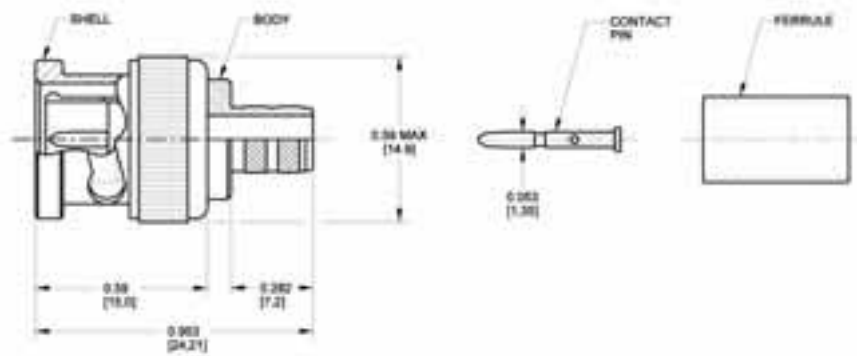

DIMENSIONS ARE FOR REFERENCE ONLY

Inch  
(mm)



# CONNECTORS

## Connector Dimension Drawings Q-G® Audio - A, AA, AAA Series

### A\*F



### A\*M



### AA\*F



### AA\*M



### AAA\*FZ



### AAA\*MZ



# CONNECTORS

## Connector Dimension Drawings Q-G® Audio - B, C, D, E Series

**B\*F**



**B\*M**



**C\*F**



**C\*M**



**D\*F**



**D\*M**



### E3FSC and E3MSC

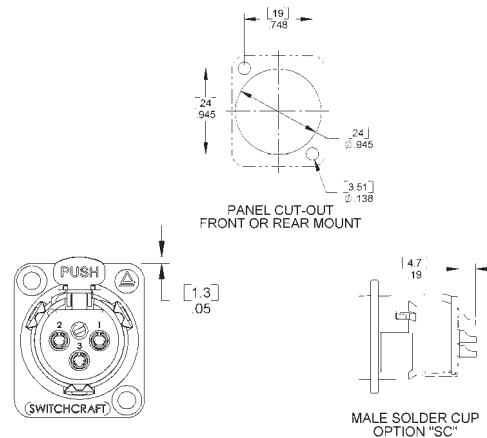

DIMENSIONS ARE FOR REFERENCE ONLY

Inch  
(mm)

# CONNECTORS

## Connector Dimension Drawings Q-G® Audio - J, K, P, R Series

J3FS



K3FS



PD3FSC1AU



PD3MSC1AU



R\*MZ



R\*FZ



# CONNECTORS

## Connector Dimension Drawings Q-G® Audio - T Series

**T3F**



**TA\*M**



**TA\*F**



**TB\*M**



**TY\*F**



DIMENSIONS ARE FOR REFERENCE ONLY Inch  
(mm)

# CONNECTORS

60

## Connector Dimension Drawings MIDI, Q-G® Audio - P Series

05BL5M



05GM5M



57GB5F



57PC5F



P\*F



P\*M



# Switche

# CONNECTORS

## Connector Dimension Drawings HPC Panel Style Series

HPC



FOR ALL TERMINALS SHOWN,  
ROUND COUNTERPARTS EXIST

[F] TERMINALS



[F1] TERMINALS



[PC] TERMINALS

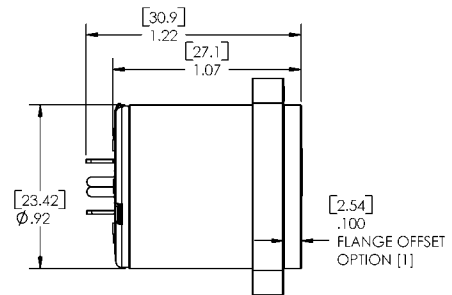

STRAIGHT 'PC' TERMINALS  
COMPONENT SIDE



[RA] + [RAP] TERMINALS



MOUNTING POST [RAP] OPTION

DIMENSIONS ARE FOR REFERENCE ONLY

Inch  
(mm)

# CONNECTORS

## 62 Connector Dimension Drawings HPC Panel Style Series

### HPC



# AUDIO ADAPTERS

## XLR to XLR, RCA, 1/4," TQ-G Adapter Series

A wide variety of audio adapters are available from Switchcraft. Ranges include XLR to XLR, XLR to RCA, XLR to 1/4", along with a multitude of specialty adapters. Our DMX adapters allow users to adapt from 5 pin DMX controls to the more prevalent 3 pin XLR.

### Ordering Information

| Part Number        | Description                              |
|--------------------|--|
| <b>XLR to XLR</b>  |  |
| 389                | 3 Pin female to 3 pin female             |
| 390                | 3 Pin male to 3 pin male                 |
| S3FM               | 3 Pin male to 3 pin female               |
| S3F5M              | 3 Pin female to 5 pin male               |
| S5F3M              | 5 Pin female to 3 pin male               |
| <b>XLR to RCA</b>  |  |
| 321                | 3 Pin female XLR to male RCA             |
| 322                | 3 Pin female XLR to female RCA           |
| 323                | 3 Pin male XLR to male RCA               |
| 324                | 3 Pin male XLR to female RCA             |
| <b>XLR to 1/4"</b> |  |
| 383A               | 3 Pin female XLR to female 1/4", 3 cond. |
| 384A               | 3 Pin male XLR to female 1/4", 3 cond.   |
| 386A               | 3 Pin female XLR to male 1/4", 3 cond.   |
| 387A               | 3 Pin male XLR to male 1/4", 3 cond.     |
| <b>XLR to TQ-G</b> |  |
| TA01               | 3 Pin XLR female to 3 pin TQG female     |
| TA02               | 4 Pin XLR female to 4 pin TQG female     |
| TA04               | 3 Pin XLR male to 3 pin TQG female       |
| TA05               | 4 Pin XLR male to 4 pin TQG female       |



DIMENSIONS ARE FOR REFERENCE ONLY

$\frac{\text{Inch}}{\text{(mm)}}$

**Switchcraft**  
www.switchcraft.com

5555 North Elston Avenue / Chicago, IL 60630  
Phone: 773-792-2700 / Fax: 773-792-2129





# AUDIO ADAPTERS

## 64 1/4" to 1/4", RCA; RCA to RCA; & Miscellaneous Adapter Series



### Ordering Information

| Part Number          | Description                            |
|----------------------|--|
| <b>1/4" to 1/4"</b>  |  |
| 361A                 | Mono female to female                  |
| 362A                 | Stereo female to female                |
| 363                  | Mono male to male                      |
| 340                  | 2 Mono jacks parallel to mono plug     |
| 352A                 | Stereo jack to mono plug               |
| <b>1/4" to RCA</b>   |  |
| 330P                 | 2 RCA jacks to mono plug, 4" cable     |
| 336A                 | Female 1/4" to male RCA                |
| 345A                 | Female RCA to male 1/4"                |
| <b>RCA to RCA</b>    |  |
| 330F1                | 2 Female RCA parallel to 1 male RCA    |
| 330F2                | 1 Male and 1 female parallel to 1 male |
| 349A                 | Female to female                       |
| <b>Miscellaneous</b> |  |
| 332A                 | Old MC1M type to 1/4" female           |
| 365                  | Tini-Jax (.141") to RCA male           |
| 370A                 | Female RCA to Tini-Plug (.141")        |
| 374                  | 1/4" female to Tini-Plug (.141")       |
| 376                  | Tini-Jax (.141") to Micro-Plug (.097") |
| 377                  | Micro-Jax (.097") to Tini-Plug (.141") |
| 44                   | Female 2500 Series to 1/4" plug        |

# JACKS & PLUGS

## Jack Series

65

### Littel Phone, Hi-D, Right Angle PC Mount 1/4", 1/4" Extension Jack Series

Switchcraft offers an extensive variety of 1/4" commercial jacks. Littel phone jacks offer open frame designs, Hi-D jacks offer an enclosed, 94V-0 rated thermoplastic housing, our RA jacks are designed for right angle PC board layouts, and our Extension jacks allow the end user to extend cable lengths. All offer a wide range of options to fit a multitude of needs. For mating plugs, look to page 83 for all of the various options.

#### Specifications

##### Mechanical

Life: 10,000 insertion/withdrawal cycles, minimum

##### Electrical

Contact Resistance: .030 ohms maximum (initial), .050 ohms maximum (after humidity, durability exposure) Per Mil-Std-202E

Insulation Resistance: 10,000 MW minimum (initial), 1,000 MW minimum (after humidity)

Dielectric Withstanding Voltage: 500V, 60 Hz (rms) AC

Contact Rating: 1A, 25 VDC

##### Environmental

Thermal Range: -55°C to +85°C (non-operating); -20°C to +65°C (operating)

Thermal Shock: Per Mil-Std-202, method 107

Humidity: Per Mil-Std-202, method 106

Salt Spray: Per Mil-Std 202, method 101

##### Materials

Mounting Bushing: Copper alloy, nickel-plated  
(RN & RA Series: Thermoplastic)

Insulation: Rigid plastic

Springs: Special copper alloy.

Integral contacts are standard in the isolated switching circuits

Sleeve Terminal: Copper alloy

Hardware: Supplied with one Number P10001 copper alloy nickel-plated hex nut, and one Number S1022 steel nickel-plated washer



See next page for ordering information

# JACKS & PLUGS

## 66 Jack Series

### Ordering Information

| Part No.                               | Conductors | Typical Description                         | Mating Plug     | Notes   |
|--|------------|---|-----------------|---|
| <b>Littel Phone Jacks</b>              |            |   |                 |   |
| 11                                     | 2          | single open                                 | 280             |   |
| 12A                                    | 2          | single closed                               | 280             |   |
| 12B                                    | 3          | double open                                 | 297             |   |
| 14B                                    | 3          | double closed                               | 297             |   |
| <b>Hi-D Jacks</b>                      |            |   |                 |   |
| 111                                    | 2          | single open                                 | 280             |   |
| 112B                                   | 3          | double open                                 | 297             |   |
| 113BPC1M                               | 3          | tip closed, ring open<br>(common to sleeve) | 297 or<br>482NC | PC terms, accepts Littel<br>and Mil-type plugs                |
| 114B                                   | 3          | double closed                               | 297             |   |
| 114BPC                                 | 3          | double closed                               | 297             | PC terms  |
| 114BPCS                                | 3          | double closed                               | 297             | Springlock PC terms   |
| 114BPC1M                               | 3          | double closed                               | 297 or<br>482NC | PC terms, accepts Littel and<br>Mil-type plugs, metric thread |
| Z15J                                   | 2          | single open                                 | 187B            | 15A rated   |
| <b>Right Angle PC Mount 1/4" Jacks</b> |            |   |                 |   |
| RA49B11                                | 2          | single open                                 | 280             |   |
| RN112APC                               | 2          | single closed                               | 280             |   |
| RA49C14B                               | 3          | double closed                               | 297             |   |
| <b>1/4" Extension Jacks</b>            |            |   |                 |   |
| 80                                     | 2          | single open                                 | 280             | Screw terms, black handle                                     |
| 88                                     | 2          | single open                                 | 280             | Solder terms, black handle                                    |
| 120                                    | 2          | single open                                 | 280             | Screw terms, shielded handle                                  |
| 121                                    | 2          | single open                                 | 280             | Solder terms, shielded handle                                 |
| 131                                    | 3          | double open                                 | 297             | Solder terms, shielded handle                                 |
| 133                                    | 3          | double open                                 | 298             | Solder terms, shielded handle,<br>locking                     |
| 830                                    | 3          | double open                                 | 297             | Screw terms, black handle                                     |
| 128                                    | 2          | single open                                 | 280             | Solder terms, shielded handle                                 |
| 1238                                   | 3          | double open                                 | 297             | Solder terms, shielded handle                                 |

See Pages 72–74 for Mechanical Drawings

# Switel

# JACKS & PLUGS

## Jack Series

67

### Thick Panel/Guitar, Locking 1/4", Tini, Tini-Extension, Micro, 3.5mm

The TP or Thick Panel jacks are typically used in applications such as loud-speaker enclosures and solid-body guitars. Only premium materials are used in the manufacture of these jacks. Locking 1/4" jacks allow the end user to lock the mating plug, providing positive detent to the connection. Also offered is a wide range of 1/8" jacks and true 3.5mm jacks.

#### Specifications - Thick Panel Series & Locking Jacks

##### Electrical

Insulation Resistance: 2 x 10<sup>6</sup> MW  
at 500 VDC per Mil-Std-202,  
method 302 (initial)  
Dielectric Withstanding Voltage:  
1,000 VAC (ms)  
Life: 10,000 cycles minimum

##### Environmental

Thermal Range: -55°C to +85°C  
(non operating); -20°C to +65°C  
(operating)  
Thermal Shock: Per Mil-Std-202,  
method 107  
Humidity: Per Mil-Std-202, method  
106  
Salt Spray: Per Mil-Std-202, method  
101

##### Materials

Shell - Locking Jacks: Die-cast  
zinc, with satin nickel-plating;  
Black chrome over nickel-plating  
on special order  
Insert and Latch: Thermoplastic,  
UL94V-0  
Latch Release: Nickel-plated  
die-cast zinc  
Contact Springs: Tin-plated  
copper alloy  
Mounting Bushing - Thick Panel  
Jacks: Nickel-plated copper alloy  
with knurled flange  
Insulating Spacer: Rigid plastic

(continued on next page)



**Switchcraft**  
www.switchcraft.com

5555 North Elston Avenue / Chicago, IL 60630  
Phone: 773-792-2700 / Fax: 773-792-2129

# JACKS & PLUGS

## 68 Jack Series

(continued from previous page)

Insulator/Spring Mount:

Thermo-plastic

Springs: Copper alloy

Terminals: Tip: Copper alloy; Ring:

(Number 152B only) Copper alloy; Sleeve: Steel, tin-plated

Hardware - Thick Panel Jacks:

Supplied with one, Number P10531 nickel-plated copper alloy hex nut; and one, Number P1476 nickel-plated copper alloy flat washer

### Specifications - 35RAPC Series

#### Electrical

Contact Resistance: 20 milliohms maximum

Insulation Resistance: 100 milliohms minimum at 250 VDC

Dielectric Withstanding Voltage: 250 VAC

Life: 5,000 cycles, minimum

Insertion Force: 0.88 pounds - 3.5 pounds

Withdrawal Force: 0.88 pounds - 2.64 pounds

#### Materials

Coil Spring: Steel Wire

Bushing: Nickel-plated copper alloy

Terminal: Silver-plated copper alloy

Tip Spring: Silver-plated copper alloy

Shunt Terminal: Plated copper alloy

Cover: Thermoplastic, transparent UL 94V-2

Body: Thermoplastic, UL 94V-1 black color

### Specifications - 35PM Series & Tini Jack Series

#### Electrical

Contact Resistance: .075 ohms maximum

Insulation Resistance: 5,000 MW minimum

Dielectric Withstanding Voltage: 250 VAC maximum

Life: 5,000 insertion/withdrawal cycles, minimum

Contact Rating: .25A, 48 VDC

#### Materials

Mounting Bushing: Nickel-plated copper alloy

Insulating Spacers: Rigid plastic

Springs: Copper alloy

Sleeve Terminal: Tin-plated copper alloy

Hardware: Supplied with one,

Number P11501 nickel-plated brass locknut; and one, Number S17901 nickel-plated steel flat washer

### Ordering Information

| Part No.                               | Conductors | Description           | Typical Mating Plug | Notes   |
|--|------------|-----------------------|---------------------|---|
| <b>Thick Panel/Guitar Jacks (1/4")</b> |            |                       |                     |   |
| 151                                    | 2          | single open           | 280                 | Nickel finish   |
| 152                                    | 3          | double open           | 297                 | Brass finish  |
| 152B                                   | 3          | double open           | 297                 | Nickel finish   |
| 153                                    | 2          | single open           | 280                 | Gold-plated springs, electro-polish brass finish, 9/16-12 UNC wood thread |
| 154                                    | 3          | double open           | 297                 | Gold-plated, no cable clamp   |
| 155                                    | 3          | double open           | 297                 | Black satin chrome finish, no cable clamp                                 |
| <b>Locking 1/4" Jacks</b>              |            |                       |                     |   |
| E111L                                  | 2          | single open           | 280                 |   |
| E112BL                                 | 3          | double open           | 297                 |   |
| <b>Tini-Jacks (.141")</b>              |            |                       |                     |   |
| 41                                     | 2          | single open           | 750                 |   |
| 42A                                    | 2          | single closed         | 750                 |   |
| 142A                                   | 2          | single closed         | 750                 |   |
| PC142A                                 | 2          | single closed         | 750                 | PC terms  |
| <b>Tini-Extension Jacks (.141")</b>    |            |                       |                     |   |
| 125                                    | 2          | single open           | 750                 |   |
| <b>3.5mm Jacks</b>                     |            |                       |                     |   |
| 35RAPC2AV                              | 2          | single closed         |                     | Threaded bushing, PC terms  |
| 35RAPC2BH3                             | 3          | double open           | 35HDNN              | Threaded bushing, PC terms  |
| 35RAPC3BH3                             | 3          | tip closed, ring open | 35HDNN              | Threaded bushing, PC terms  |
| 35RAPC4BH3                             | 3          | double closed         | 35HDNN              | Threaded bushing, PC terms  |
| 35RAPC7J                               | 3          | top jack dual open    | 35HDNN              | Dual vertical jack bottom jack dual closed                                |
| 35RAPC7JS                              | 3          | top jack dual open    | 35HDNN              | Dual vertical jack, shielded bottom jack dual closed                      |
| 35PM1                                  | 2          | single open           | 750                 |   |
| 35PM2A                                 | 2          | single closed         | 750                 |   |

See Pages 75-79 for Mechanical Drawings

# Switel

# JACKS & PLUGS

## Jack Series

### Phono, Phono Extension, TT or Bantam, MT 1/4" Jack Series

Phono jacks, more commonly called RCA jacks offer low cost, two conductor connections. TT or bantam jacks are the same type used in our audio patchbays. Typically used in high end studio applications. MT or 1/4" jacks are just a bigger version of the TT jacks. Same high quality, just in a larger package.

#### Specifications - Phono Jacks

##### Materials

Frame and Shell: Steel, plated  
 Center Terminal: Plated copper alloy (3517PC); Plated copper alloy (3514PC)  
 Insulator: Thermoplastic (3514PC) Ceramic and glass filled thermoplastic (3517PC)

##### For 3515PC Only:

Contact and Saddle: Spring type copper alloy, copper alloy pre-tinned  
 Shell: Steel or copper alloy, plated  
 Insulator Bushing: Ceramic  
 Insulator Spacer: Glass-filled thermoplastic

#### Specifications - TT and MT Jacks

##### Mechanical

Life: Commercial – 30,000 insertion/withdrawal cycles, minimum; Military – 30,000 insertion/withdrawal cycles, minimum  
 Mechanical Shock: Military – Per Mil-Std-202, method 213, Test Condition H (75g)  
 Vibration: Military – Per Mil-Std-202, method 213, (10-55 Hz)

##### Electrical

Contact Resistance: Commercial – .030 ohms maximum (initial), .050 ohms maximum (after humidity, durability, exposure); Military – .010 ohms maximum (initial), .020 ohms maximum (after life), .10 ohms maximum (after salt spray)  
 Insulation Resistance: Commercial – 10,000 MΩ minimum (initial), 1,000 MΩ minimum (after humidity); Military – 10,000 MΩ minimum (initial), 1,000 MΩ minimum (after humidity, durability exposure)  
 Dielectric Withstanding Voltage: 500V, 60 Hz (rms) AC

(continued on next page)



# JACKS & PLUGS

## 70 Jack Series

(continued from previous page)

### Environmental

Thermal Range: Commercial –  
55°C to +85°C (non-operating), -  
20°C to +65°C (operating);  
Military –  
-55°C to +85°C (non operating), -  
40°C to +65°C  
(operating)  
Thermal Shocks: Commercial –  
Per Mil-Std-202, method 107;  
Military – Per Mil-Std-202,  
method 107  
Humidity: Commercial –

Per Mil-Std-202, method 106;  
Military — 0% to 95% operating  
and non-operating  
Salt Spray: Commercial –  
Per Mil-Std-202, method 101;  
Military – Per Mil-Std-202,  
method 101 (48 hours)  
Moisture Resistance: Military –  
Per Mil-Std-202, method 106  
(240 hours)

### Materials

Frame: Steel, nickel plated  
Springs: Copper alloy  
Contacts: Welded, crossbar, gold  
plated

### Ordering Information

| Part No.                     | Conductors | Typical Description | Mating Plug | Notes                                 |
|------------------------------|------------|---------------------|-------------|---------------------------------------|
| <b>Phono Jacks</b>           |            |                     |             |                                       |
| 3501FP                       | 2          | single open         | 3502A       | Front mounting                        |
| 3501FR                       | 2          | single open         | 3502A       | Rear mounting                         |
| 3514PC                       | 2          | single open         | 3502A       | Right angle, PC mount                 |
| 3517PC                       | 2          | single open         | 3502A       | Right angle, PC mount                 |
| BPJR**                       | 2          | single open         | 3502A       | Rear mounting, colored insulators     |
| BPJR**AU                     | 2          | single open         | 3502A       | Same as above, with gold-plating      |
| BPJF**                       | 2          | single open         | 3502A       | Front mounting, colored insulators    |
| BPJF**AU                     | 2          | single open         | 3502A       | Same as above, with gold-plating      |
| BPJJ**                       | 2          | single open         | 3502A       | Feed through mount                    |
| BPJJ**AU                     | 2          | single open         | 3502A       | Same as above, with gold-plating      |
| <b>Phone Extension Jacks</b> |            |                     |             |                                       |
| 3503                         | 2          | single open         | 3502A       |                                       |
| <b>TT or Bantam Jacks</b>    |            |                     |             |                                       |
| TT34B                        | 3          | double closed       | TT253NC     |                                       |
| TT34BNY                      | 3          | double closed       | TT253NC     | Nickel-plated frame, fanned terminals |
| WTT34B                       | 3          | double closed       | TT253NC     | Wire-wrap terminals                   |
| <b>MT 1/4" Jacks</b>         |            |                     |             |                                       |
| MT334B                       | 3          | double closed       | 482NC       |                                       |
| WMT334B                      | 3          | double closed       | 482NC       | Wire-wrap terminals                   |
| YMT334BN                     | 3          | double closed       | 482NC       | Nickel-plated frame, fanned terminals |

\*\* To designate color of insulator, use: 01- Black, 02 - Red, 03 - White, 04 - Yellow, 05 - Blue, 06 - Green

See Pages 80-82 for Mechanical Drawings

# Switel

# JACKS & PLUGS

## Power/Jacks Plugs Series 700, S700, 800 Cord & Panel Style Series

71

Low power AC to DC power jacks and plugs are used throughout the audio industry, to power a wide variety of products. Switchcraft offers both cord plug and panel mount versions, including locking and non-locking versions.

### Specifications - Plugs

#### Electrical:

Current (Carry): 5 amps

#### Materials

Plug Sleeve and Pin: Nickel-plated copper alloy  
 Lock Ring: Nickel-plated copper alloy  
 Lock Ring Thread Size: 5/16" - 32 UNEF 2B  
 Finger Insulator: Molded plastic  
 Insulating Washers: Rigid plastic  
 Sleeve Terminal: Copper alloy, electro-tinned  
 Handle: Molded plastic  
 Handle Thread Size: 5/16" - 24 UNF 2B

### Specifications - Jacks

#### Mechanical

Life: 10,000 insertion/withdrawal cycles minimum  
 Insertion/Withdrawal Forces:  
 3 pound insertion (maximum),  
 4 ounce minimum withdrawal

#### Electrical

Contact Resistance: .01 ohms maximum (initial), .02 ohms maximum (after humidity, durability exposure), .1 ohms maximum (after salt spray)  
 Insulation Resistance: 10,000 MW minimum (initial), 1,000 MW minimum (after humidity, durability exposure)  
 Dielectric Withstanding Voltage: 500 VAC maximum  
 Contact Rating: 5A, 12 VDC resistive



#### Materials

Housing: Molded plastic  
 Mounting Bushing and Hex Nut: Plated copper alloy  
 Pin, Spring and Terminals: Plated copper alloy  
 Insulators: Rigid plastic  
 Hardware: Supplied with one

Number P2439 nickel-plated brass hex nut, and one Number P2441 nickel-plated steel flat washer

#### Ordering Information

| Part Number | Style | Notes                                     |
|-------------|-------|---|
| 712A        | Panel | 0.100" center pin                         |
| 722A        | Panel | 0.080" center pin                         |
| 732A        | Panel | 0.050" center pin                         |
| 760         | Cord  | 0.100" center hole, black handle          |
| 765         | Cord  | 0.100" center hole, red handle            |
| S760        | Cord  | 0.080" center hole, black handle          |
| S765        | Cord  | 0.080" center hole, red handle            |
| 860         | Cord  | 0.050" center hole, black handle          |
| 865         | Cord  | 0.050" center hole, red handle            |
| 760K        | Cord  | 0.100" center hole, black handle, locking |
| S760K       | Cord  | 0.080" center hole, black handle, locking |

See Next Page for Mechanical Drawings



# JACKS & PLUGS

## 72 Jack Series Dimension Drawings Littel Phone, Hi-D, 1/4" Extension, 700 Panel Jack Series

11, 12A, 12B, 14B



11 Series



12A Series



12B Series



14B Series

712A



Z15J



80



# JACKS & PLUGS

## Jack Series Dimension Drawings Littel Phone, Hi-D, 1/4" Extension Jack Series

### Solder Lug Terminals for Hi-D Jax - 111, 112B, 114B



### Spring Lock PC Terminals for Hi-D Jax - 114BPCS



### PC Terminals for Hi-D Jax - 113BPC1M, 114BPC1M



DIMENSIONS ARE FOR REFERENCE ONLY  $\frac{\text{Inch}}{(\text{mm})}$

# JACKS & PLUGS

74

## Jack Series Dimension Drawings Right Angle PC Mount 1/4" Jack Series

RA49B11

RA49C14B



RECOMMENDED PC BOARD LAYOUT (COMPONENT SIDE)

RN112APC



RECOMMENDED PC BOARD LAYOUT (Component Side)

# JACKS & PLUGS

## Jack Series Dimension Drawings Thick Panel/Guitar, Locking 1/4", Tini, Tini Extension Jack Series

151, 153



E111L, E112BL



41, 42A

125



DIMENSIONS ARE FOR REFERENCE ONLY

Inch  
(mm)

# JACKS & PLUGS

76

## Jack Series Dimension Drawings Micro, 3.5mm Jack Series

142, PC142A

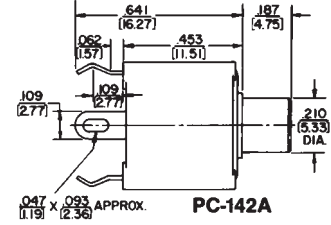
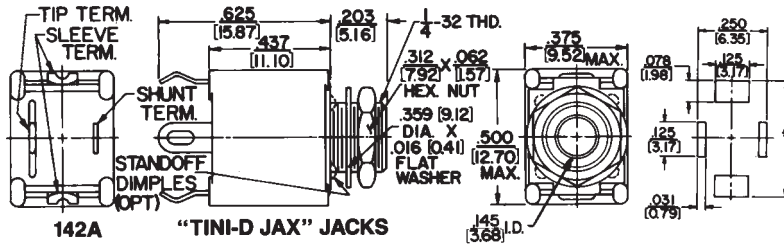

- \* 406 FOR .062 THK. BOARD (10.31 [1.57])
- \* 422 FOR .078 THK. BOARD (10.72 [1.98])
- \* 437 FOR .093 THK. BOARD (11.10 [2.36])

**RECOMMENDED  
PC BOARD LAYOUTS**

35RAPC2AV

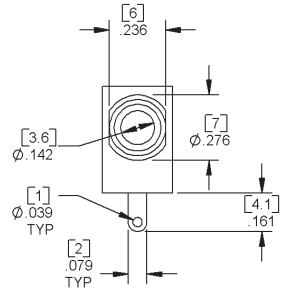
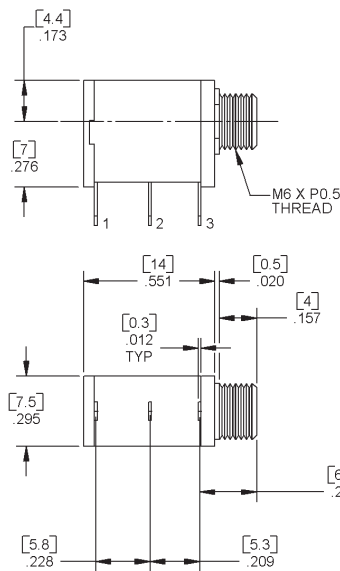

| PART NUMBER | SCHEMATIC |
|-------------|-----------|
| 35RAPC2AV   |           |

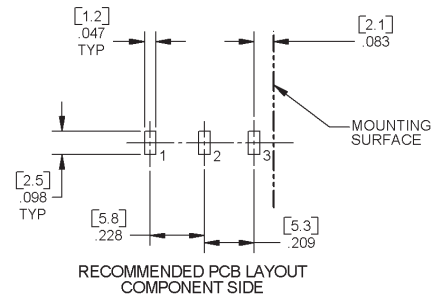

# Switel

# JACKS & PLUGS

## Jack Series Dimension Drawings 3.5mm Jack Series

35RAPC2BH3, 35RAPC3BH3, 35RAPC4BH3



DIMENSIONS ARE FOR REFERENCE ONLY  $\frac{\text{Inch}}{(\text{mm})}$



# JACKS & PLUGS

78

## Jack Series Dimension Drawings 3.5mm Jack Series

35RAPC7J, 35RAPC7JS



SCHEMATIC

# JACKS & PLUGS

## Jack Series Dimension Drawings 3.5mm Jack Series

### 35PM1



### 35PM2A



DIMENSIONS ARE FOR REFERENCE ONLY  $\frac{\text{Inch}}{\text{(mm)}}$



# JACKS & PLUGS

## Jack Series Dimension Drawings Phono and Phono Extension Jack Series

3501FP



BPJJ Series



3501FR



BPJF Series



3503 Extension



BPJR Series



3514PC, 3517PC



# JACKS & PLUGS

## Jack Series Dimension Drawings TT or Bantam Jack Series

TT34B, TT34BN, WTT34B



DIMENSIONS ARE FOR REFERENCE ONLY

Inch  
(mm)

**Switchcraft**  
www.switchcraft.com

5555 North Elston Avenue / Chicago, IL 60630  
Phone: 773-792-2700 / Fax: 773-792-2129



# JACKS & PLUGS

82

## Jack Series Dimension Drawings MT 1/4" Jack Series

MT334B, WMT334B, YMT334BN



# Switel

# JACKS & PLUGS

Plug Series **83**

## Littel 1/4", Right Angle 1/4", Silent, Super Heavy Duty Plug Series

Switchcraft Littel Plugs all feature one-piece tip rods for added strength and durability. All are offered in a wide variety of configurations, including straight, right angle, shielded, screw or solder terminals. The Heavy Duty Speaker plugs have larger cable clamps and are rated at 15A. The Silent plugs have a unique circuit-closing device which stops hums, pops, and squeals when the plug is removed or inserted from the jack. Miti plugs feature heavy duty brass construction, rugged cable clamps, and spring flex reliefs. All plugs meet EIA standards for tip configuration, which ensures you they mate properly with the jack.



### Specifications

#### Electrical

- Contact Resistance (typical Depends on Mating Jack):  
< 0.020 ohms
- Dielectric Withstand Voltage: 500 VAC (minimum)
- Insulation Resistance @ 500 VDC: 2,000 megohms (minimum)
- Insulation Resistance (after Mil-Std-202 Salt Spray): 1,000 megohms (minimum)
- Working Voltage: 250 VAC, 140 VDC
- Insert/Withdrawal Force:  
Depends on Mating Jack
- Soldering Requirement:  
ANSI/J-Std-001
- Temperature Range: -40°C to +85°C
- U.L. Component Recognition File No: E118169
- Life: Depends on Mating Jack

#### Materials

- Tip: Nickel-plated copper alloy
- Sleeve: Nickel-plated copper alloy
- Handle: Nickel-plated copper alloy
- Tip Terminal: Copper alloy, electrotin-plated
- Cable Clamp: Copper alloy, electro-tinplated

See Next Page for Ordering Information

DIMENSIONS ARE FOR REFERENCE ONLY

$\frac{\text{Inch}}{\text{(mm)}}$

**Switchcraft**<sup>®</sup>  
www.switchcraft.com

5555 North Elston Avenue / Chicago, IL 60630  
Phone: 773-792-2700 / Fax: 773-792-2129

# JACKS & PLUGS

## 84 Plug Series

### Ordering Information

| Part No.                        | Typical<br>Conductors | Terminals | Mating Jack | Handle   | Notes   |
|---------------------------------|-----------------------|-----------|-------------|----------|---|
| <b>1/4" Littel Plug Series</b>  |                       |           |             |          |   |
| 240                             | 2                     | Screw     | 11          | Black    |   |
| 245                             | 2                     | Screw     | 11          | Red      |   |
| 250                             | 2                     | Solder    | 11          | Black    |   |
| 260                             | 2                     | Screw     | 11          | Black    |   |
| 270                             | 2                     | Screw     | 11          | Black    |   |
| 280                             | 2                     | Solder    | 11          | Shielded |   |
| 281                             | 2                     | Solder    | 11          | Shielded | Unassembled                                   |
| 580                             | 2                     | Solder    | 11          | Shielded | Diecast handle                                |
| 285                             | 2                     | Solder    | 11          | Shielded | Unassembled                                   |
| 285L                            | 2                     | Solder    | 11          | Shielded | Larger cable clamp                            |
| 267                             | 3                     | Solder    | 12B         | Black    |   |
| 290                             | 3                     | Screw     | 12B         | Shielded |   |
| 297                             | 3                     | Solder    | 12B         | Shielded |   |
| 299                             | 3                     | Solder    | 12B         | Shielded | Diecast handle                                |
| <b>Heavy Duty Speaker Plugs</b> |                       |           |             |          |   |
| 184                             | 2                     | Solder    | 11 or Z15J  | Shielded | Accepts Cable OD up to .375"                  |
| 188                             | 2                     | Solder    | 11 or Z15J  | Shielded | Accepts Cable OD up to .450"                  |
| 187                             | 2                     | Solder    | 11 or Z15J  | Shielded | Accepts Cable OD up to .330"                  |
| 187B                            | 2                     | Solder    | 11 or Z15J  | Shielded | Black Handle, accepts Cable<br>OD up to .330" |
| <b>Right Angle 1/4" Plugs</b>   |                       |           |             |          |   |
| 226                             | 2                     | Solder    | 11          | Shielded |   |
| 228                             | 2                     | Solder    | 11          | Shielded | Flat handle                                   |
| 236                             | 3                     | Solder    | 12B         | Shielded |   |
| 238                             | 3                     | Solder    | 12B         |          | Flat handle                                   |
| <b>Silent Plug</b>              |                       |           |             |          |   |
| 172                             | 2                     | Screw     | 11          | Shielded |   |
| 181                             | 2                     | Solder    | 11          | Shielded |   |
| <b>Miti Plugs</b>               |                       |           |             |          |   |
| 174S                            | 2                     | Solder    | 11 or Z15J  | Shielded | Brass finish, spring flex relief              |

See Pages 88-89 for Mechanical Drawings

# Switel

# JACKS & PLUGS

## Plug Series

85

### Tini, Micro, 3.5mm Stereo, Right Angle 3.5mm Stereo, Phono, Right Angle Phono Plugs Series

Switchcraft offers a wide variety of Tini, Micro, 3.5mm, and RCA or Phono plugs. Tini plugs are 2 conductor plugs with plug finger diameters of .141" or 3.57mm. Micro plugs are 2 conductor plugs with plug finger diameters of .097" or 2.47mm. Our 35HD Series are true 3.5mm plugs, available in both straight and right angle versions; and available only in 3 conductor. The RCA or Phono plugs come with either hollow pins or solid pins. The 3502 offers hollow pins and standard size handle, the 3502L offers the same pin, but with a larger handle, accommodating cables up to .290". The 3502A and 3502RA Series offer solid pins and the larger cable clamps and handles. The 3558 Series offers a low cost alternative, with hollow pins and plastic handles.



#### Specifications

##### Mechanical

Life rating: 5,000 insertion/  
withdrawals  
Insertion/Withdrawal Force: 1 lb  
(depending on mating jack)

##### Electrical

Insulation Resistance:  
> 100 megohms  
Dielectric Withstanding Voltage:  
250 VAC

##### Environmental

Thermal Range: -55°C to +85°C  
(non operating); -20°C to 65°C  
(operating)  
Thermal Shock: Mil-Std 202,  
method 107  
Humidity: Mil-Std 202,  
method 106  
Salt Spray: Mil-Std 202,  
method 101  
(continued on next page)



# JACKS & PLUGS

## 86 Plug Series

### Materials

Tip, Rod and Body (also integral coupling collar on lock micro-plug):  
Nickel-plated copper alloy  
Insulation: Molded thermoplastic  
Sleeve Termination and Cable Clamp: Tinned copper alloy

Handle: Nickel-plated copper alloy, or anodized aluminum, or thermoplastic. See factory for details.

### Ordering Information

| Part No.                              | Conductors | Terminals | Typical Mating Jack | Handle         | Notes                         |
|---------------------------------------|------------|-----------|---------------------|----------------|-------------------------------|
| <b>Tini-Plug (.141")</b>              |            |           |                     |                |                               |
| 740                                   | 2          | Screw     | 41                  | Black          |                               |
| 750                                   | 2          | Solder    | 41                  | Black          |                               |
| 755                                   | 2          | Solder    | 41                  | Red            |                               |
| 780                                   | 2          | Solder    | 41                  | Shielded       |                               |
| <b>Micro-Plugs (.097")</b>            |            |           |                     |                |                               |
| 850                                   | 2          | Solder    | TR2A                | Black          |                               |
| 855                                   | 2          | Solder    | TR2A                | Red            |                               |
| 851                                   | 2          | Solder    | TR2A                | Black          | Locking version               |
| 880                                   | 2          | Solder    | TR2A                | Shielded       |                               |
| 881                                   | 2          | Solder    | TR2A                | Shielded       | Locking version               |
| <b>3.5mm Stereo Plugs</b>             |            |           |                     |                |                               |
| 35HDNN                                | 3          | Solder    |                     | Shielded       |                               |
| 35HDBAU                               | 3          | Solder    |                     | Black Shielded | Gold-plated finger            |
| 35HDNAU                               | 3          | Solder    |                     | Shielded       | Gold-plated finger            |
| <b>3.5mm Right Angle Stereo Plugs</b> |            |           |                     |                |                               |
| 35HDRANN                              | 3          | Solder    |                     | Shielded       |                               |
| 35HDRABAU                             | 3          | Solder    |                     | Black Shielded | Gold-plated finger            |
| 35HDRAAU                              | 3          | Solder    |                     | Shielded       | Gold-plated finger            |
| <b>Phono Plugs</b>                    |            |           |                     |                |                               |
| 3502                                  | 2          | Solder    | 3501FP              | Shielded       | Hollow Pin                    |
| 3502A                                 | 2          | Solder    | 3501FP              | Shielded       | Large cable clamp, solid pin  |
| 3502AAU                               | 2          | Solder    | 3501FP              | Shielded       | Gold-plated finger            |
| 3502ABAU                              | 2          | Solder    | 3501FP              | Black shielded | Gold-plated finger            |
| 3502L                                 | 2          | Solder    | 3501FP              | Shielded       | Hollow pin, large cable clamp |
| 35581                                 | 2          | Solder    | 3501FP              | Red            | Plastic handle                |
| 35582                                 | 3          | Solder    | 3501FP              | Black          | Plastic handle                |
| 35585                                 | 3          | Solder    | 3501FP              | White          | Plastic handle                |
| <b>Right Angle Phono Plugs</b>        |            |           |                     |                |                               |
| 3502RA                                | 2          | Solder    | 3501FP              | Shielded       |                               |
| 3502RABAU                             | 2          | Solder    | 3501FP              | Black Shielded | Gold-plated finger            |
| 3502RAAU                              | 2          | Solder    | 3501FP              | Shielded       | Gold-plated finger            |

See Pages 90-92 for Mechanical Drawings

# Switel

# JACKS & PLUGS

## Plug Series

### TT or Bantam, Mil-Style 1/4" Plugs Series

Switchcraft leads the industry when developing innovative TT and MT Style plugs. Our "N" version plugs offer nickel-plated plug fingers to reduce tarnishing and corrosion. Our "NC" version plugs not only offer nickel-plated plug fingers, but also large, easy to use solder cups and terminals, plus easy to use cable clamps that really secure your cable to the plugs.

#### Specifications

#### Materials

- Tip Rod, Body and Screws:  
Copper alloy, natural finish
- Terminals (NC Version): Tinned copper alloy
- Insulation: Thermoplastic, per Mil-P-22985, Type II, Class 1
- Handles: Thermoplastic, Type 6, per Mil-M-20693, Type II
- Shielded (NC Version): Machined from copper alloy, nickel-plated



See Page 93 for Mechanical Drawings

#### Ordering Information

| Part No.                   | Conductors | Terminals | Handle         | Notes                |
|----------------------------|------------|-----------|----------------|----------------------|
| <b>TT or Bantam Plugs</b>  |            |           |                |                      |
| TT253                      | 3          | Screw     | Black          |                      |
| TT253N                     | 3          | Screw     | Black          | Nickel-plated finger |
| TT253NC                    | 3          | Solder    | Black          | Nickel-plated finger |
| TT254                      | 3          | Screw     | Red            |                      |
| TT254N                     | 3          | Screw     | Red            | Nickel-plated finger |
| TT254NC                    | 3          | Solder    | Red            | Nickel-plated finger |
| <b>Mil-Style 1/4 Plugs</b> |            |           |                |                      |
| 480                        | 3          | Screw     | Black          | 0.206" OD            |
| 482                        | 3          | Screw     | Red            |                      |
| 482N                       | 3          | Screw     | Red            | Nickel-plated finger |
| 482NC                      | 3          | Solder    | Red Shielded   | Nickel-plated finger |
| 482NCP                     | 3          | Solder    | Red            | Nickel-plated finger |
| 483                        | 3          | Screw     | Black          |                      |
| 483N                       | 3          | Screw     | Black          | Nickel-plated finger |
| 483NC                      | 3          | Screw     | Black Shielded | Nickel-plated finger |
| 483NCP                     | 3          | Solder    | Black          | Nickel-plated finger |
| 484                        | 3          | Screw     | Red            | 0.206" OD            |
| 485NC                      | 3          | Solder    | Shielded       | Nickel-plated finger |



# JACKS & PLUGS

88

## Plug Series Dimension Drawings Littel Plug 1/4" Series

260



No. 260 typical — shown with screw-type terminals and plastic handle.

280 Typical



No. 280 typical — shown with solder lug terminals, cord clamp and shielded handle.

188



187BL



No. 187BL (Typical)

# Switel

# JACKS & PLUGS

## Plug Series Dimension Drawings Littel Right Angle 1/4", Silent, Super Heavy Duty Plug Series

### 228 Right Angle 1/4" Plugs



### 236 Right Angle 1/4" Plugs



### 172



### 181 Silent Plug



### 174S Super Heavy Duty Plug

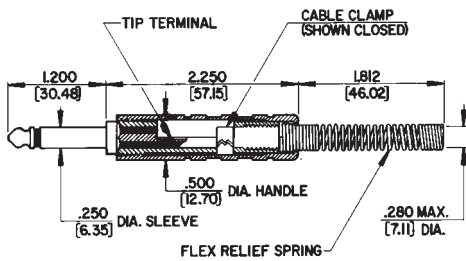

DIMENSIONS ARE FOR REFERENCE ONLY

Inch  
(mm)

# JACKS & PLUGS

90

## Plug Series Drawings Tini, Micro Plug Series

### 740, 750 Tini-Plugs

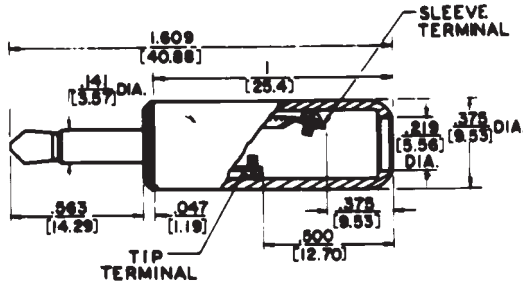

740 Screw Terminals Series

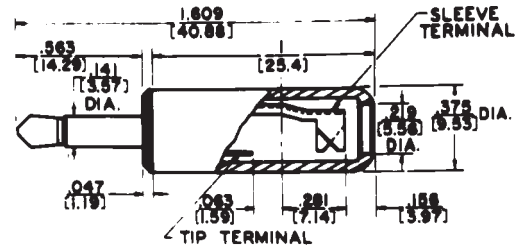

750 Clamp-Lug Terminals

### 850, 851 Micro Plugs

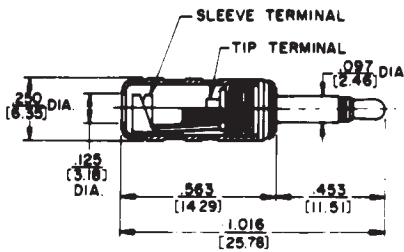

850 (typical) Series

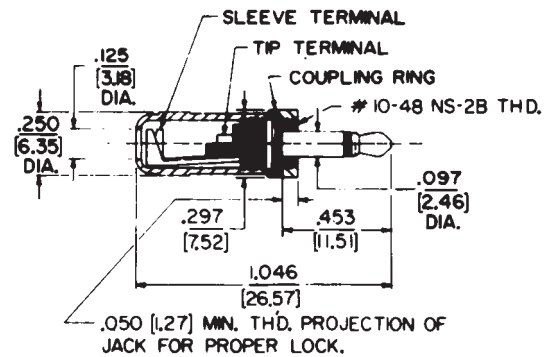

851 (typical) Series

# Switel

# JACKS & PLUGS

## Plug Series Drawings 35HD 3.5mm Stereo Plug Series

### 35HDNN, 35HDBAU, 35HDNAU



### 35HDRANN, 35HDRABAU, 35HDRAAU



DIMENSIONS ARE FOR REFERENCE ONLY  $\frac{\text{Inch}}{\text{(mm)}}$

# JACKS & PLUGS

92

## Plug Series Drawings Phono and Phone Right Angle Plug Series

### 3502, 3502A, 35581 Phono Plug

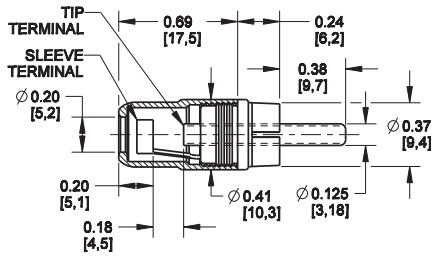

3502 Series



35581 Series



3502A Series

### 3502RA Plug



# JACKS & PLUGS

## Plug Series Drawings TT or Bantam, Mil-Style 1/4" Plug Series

### TT253, TT253NC Plug



TT253 Series



TT253NC Series

### 480, 482, 482NC, 484 Mil-Style 1/4" Plug



480 Series



482NC Series



482 Series

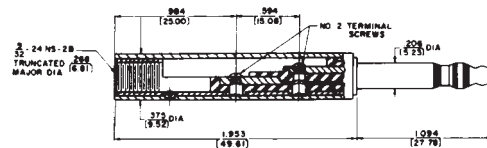

484 Series

DIMENSIONS ARE FOR REFERENCE ONLY  $\frac{\text{Inch}}{\text{(mm)}}$

# SWITCHES

## 94 Switch Series Guitar and Knobs, and Broadcast Switch Series

The 12000 Series switches are premium grade switches used primarily in guitars as pick-up switches. The largest names in the industry rely on our switches for quality and durability. Our 84000 Series and PL Series switches are used in broadcast studios, theater lighting, anywhere large illuminated switches are needed.

### Specifications - 12000 Series

#### Electrical

Contact Ratings: Fine silver contacts rated at 3A, 300W maximum AC non-inductive load standard. Other contacts available  
Leakage Resistance: 1,000 MW or greater  
Dielectric Strength: 250 VDC

#### Materials

Frame: Copper alloy, plated (3,000, 13,000); Steel, plated (12,000)  
Bushing and Shaft: Copper alloy, plated  
Springs: Copper alloy  
Knob: Black molded thermoplastic  
Mounting Hardware: Knurled copper alloy locknut T10711, supplied. P10531 hex locknut, special order  
Insulation: Rigid plastic spacers with plastic tubing through stack. Rigid plastic and/or thermoplastic lifters. Thermoplastic cam on actuator end

### Specifications - 8400 Series

#### Electrical

Temperature Range: -22°F to 158°F (-30°C to +70°C)  
Dielectric Strength: 1 kV DC  
Leakage Resistance: 1,000 MW or greater

#### Materials

Mounting/Retaining Clips and Covers: Steel, plated  
Contact Ratings: Gold crossbar rated at 1A, 200W Maximum AC non-inductive loads  
(continued on next page)



**Note: Knobs must be ordered separately.**



# Switche

(continued from previous page)

Springs: Copper alloy, plated  
Lamp Terminals: Copper alloy, plated  
Lamp Socket: Zinc, plated  
Terminals: Copper alloy, plated,  
straight solder lugs  
Housing, Escutcheon, Knob,  
Actuator and Switching Stacks  
Insulation: Molded plastic

### Specifications - PL Series

PUSH-LITE Switches Series and  
PL Indicators

#### Contacts

Welded crossbar Gold Alloy,  
rated at 2 amps., 200 watts  
max., AC non-inductive load.

#### Electrical

6,000 Minimum Life (Gold  
Alloy Contacts) per UL 1054.

#### Materials

Push-Lite Switch Assemblies:  
Housing, Lifters, Switch Modules,  
Barriers and Pushbuttons:  
Molded Plastics  
Contacts Springs: Phosphor  
Bronze, Silver Plated  
Lamp Terminals: Brass, Silver plated  
Lamp Socket, Light Divider and  
Yoke Assembly: Nickel Silver  
Mounting Bracket and Retaining  
Clips: Steel with iridescent  
iridite over Cadmium Plating

Series PL Pushbuttons:

Housing, Color Filter Inserts and  
Display Screens: High impact  
thermoplastic

PL Indicators:

Housing: Molded glass filled  
Plastics  
Mounting Bracket: Steel, irides-  
cent over cadmium Plating.  
Lamp Retainer and Terminals:  
Nickel Silver.  
Display Screen (Pushbutton):  
Molded Plastics.

### Ordering Information

| Part Number               | Circuitry                     | Description   |
|---------------------------|-------------------------------|---|
| <b>Guitar Switches</b>    |                               |   |
| 12010                     | SPST(NC)/SPST(NC)             | Straight, nickel finish, riveted silver contacts          |
| 12011                     | SPST(NC)/SPST(NC)             | Straight, bright brass finish, riveted silver contacts    |
| 12012                     | SPDT(non-shorting)/SPST(NC)   | Right angle, nickel finish, welded silver contacts        |
| 12013                     | SPST(NC)/SPST(NC)             | Right angle, nickel finish, welded silver contacts        |
| 12014                     | SPST(NC)/SPST(NC)             | Right angle, black finish, welded silver contacts         |
| 12015                     | DPDT(NC)/DPDT(NC)             | Right angle, nickel finish, welded silver contacts        |
| 12016                     | SPST(NC)/SPST(NC)             | Right angle, bright brass finish, riveted silver contacts |
| 12017                     | SPST(NC)/SPST(NC)             | Right angle, nickel finish, welded gold contacts          |
| <b>Knobs</b>              |                               |   |
| T12742                    |                               | Black   |
| T12745                    |                               | White   |
| T127410                   |                               | Ivory   |
| P2912                     |                               | Amber   |
| <b>Broadcast Switches</b> |                               |   |
| 84206L                    | DPDT                          | 2 Position, locking                                       |
| 84306L                    | SPDT(non-shorting) both sides | 3 Position, locking                                       |
| 84312L                    | DPDT both sides               | 3 Position, locking                                       |
| 84324L                    | DPDT both sides               | 3 Position, locking                                       |
| K131                      |                               | Filter kit, 3 of ea. (amb, blu, grn, red, wht, and yel)   |
| PL106205                  | DPDT                          | Momentary, single lamp                                    |
| PL206205                  | DPDT                          | Momentary, twin lamp                                      |
| PL106705                  | DPDT                          | Push-lock/Push-release, single lamp                       |
| PL206705                  | DPDT                          | Push-lock/Push-release, twin lamp                         |

### See Next Page for Mechanical Drawings



# SWITCHES

## 96 Switch Series Drawings Guitar and Knobs, and Broadcast Switch Series

### 12000 Series RA Lev-R® Switches



### 84000 Series Lever-Lite® Switches



### 12000 Series Straight Lev-R® Switches



### PL Series Push-Lite® Switches



# Switches

DIMENSIONS ARE FOR REFERENCE ONLY  $\frac{\text{Inch}}{(\text{mm})}$

**Switchcraft**<sup>®</sup>  
w w w . s w i t c h c r a f t . c o m

5555 North Elston Avenue / Chicago, IL 60630  
Phone: 773-792-2700 / Fax: 773-792-2129

# INDEX

|                 |                |                   |                        |
|-----------------|----------------|-------------------|------------------------|
| 05AD05.....45   | 172.....84     | 340.....64        | 42A.....68             |
| 05AK05.....45   | 174S.....84    | 345A.....64       | 44.....64              |
| 05AK25.....45   | 181.....84     | 349A.....64       | 480.....87             |
| 05AN05.....45   | 184.....84     | 3501FP.....70     | 482.....87             |
| 05AN15.....45   | 187.....84     | 3501FR.....70     | 482N.....87            |
| 05AN25.....45   | 187B.....84    | 3502.....86       | 482NC.....87           |
| 05AN80.....45   | 188.....84     | 3502A.....86      | 482NCP.....87          |
| 05AU05.....45   | 18QD18.....45  | 3502AAU.....86    | 483.....87             |
| 05AU80.....45   | 18QF18.....45  | 3502ABAU.....86   | 483N.....87            |
| 05BL5M.....53   | 18QH18.....45  | 3502L.....86      | 483NC.....87           |
| 05DL5M.....53   | 20QD20N.....45 | 3502RA.....86     | 483NCP.....87          |
| 05GM5M.....53   | 20QF20N.....45 | 3502RAAU.....86   | 484.....87             |
| 10BF10.....45   | 20QH20N.....45 | 3502RABAU.....86  | 485NC.....87           |
| 10BK10.....45   | 226.....84     | 3503.....70       | 516-090-000-301.....20 |
| 10BN10.....45   | 228.....84     | 3514PC.....70     | 516-090-000-302.....20 |
| 11.....66       | 236.....84     | 3517PC.....70     | 516-120-000-101.....20 |
| 111.....66      | 238.....84     | 352A.....64       | 516-120-000-102.....20 |
| 112B.....66     | 240.....84     | 35581.....86      | 516-290-500.....20     |
| 113BPC1M.....66 | 245.....84     | 35582.....86      | 516-290-590.....20     |
| 114B.....66     | 250.....84     | 35585.....86      | 57GB5F.....53          |
| 114BPC.....66   | 2501F.....53   | 35HDBAU.....86    | 57PC5F.....53          |
| 114BPC1M.....66 | 2501M.....53   | 35HDNAU.....86    | 57PC5FS.....53         |
| 114BPCS.....66  | 2501MP.....53  | 35HDNN.....86     | 580.....84             |
| 120.....66      | 25AF25.....45  | 35HDRAAU.....86   | 712A.....71            |
| 12010.....95    | 25AK25.....45  | 35HDRABAU.....86  | 722A.....71            |
| 12011.....95    | 25AK82.....45  | 35HDRANN.....86   | 732A.....71            |
| 12012.....95    | 25AN25.....45  | 35PM1.....68      | 740.....86             |
| 12013.....95    | 260.....84     | 35PM2A.....68     | 750.....86             |
| 12014.....95    | 267.....84     | 35RAPC2AV.....68  | 755.....86             |
| 12015.....95    | 270.....84     | 35RAPC2BH3.....68 | 760.....71             |
| 12016.....95    | 280.....84     | 35RAPC3BH3.....68 | 760K.....71            |
| 12017.....95    | 281.....84     | 35RAPC4BH3.....68 | 765.....71             |
| 121.....66      | 285.....84     | 35RAPC7J.....68   | 780.....86             |
| 1238.....66     | 285L.....84    | 35RAPC7JS.....68  | 80.....66              |
| 125.....68      | 290.....84     | 361A.....64       | 830.....66             |
| 128.....66      | 297.....84     | 362A.....64       | 84206L.....95          |
| 12A.....66      | 299.....84     | 363.....64        | 84306L.....95          |
| 12B.....66      | 30AK30.....45  | 365.....64        | 84312L.....95          |
| 131.....66      | 30AN30.....45  | 370A.....64       | 84324L.....95          |
| 133.....66      | 30AR30.....45  | 374.....64        | 850.....86             |
| 142A.....68     | 321.....63     | 376.....64        | 851.....86             |
| 14B.....66      | 322.....63     | 377.....64        | 855.....86             |
| 151.....68      | 323.....63     | 383A.....63       | 860.....71             |
| 152.....68      | 324.....63     | 384A.....63       | 865.....71             |
| 152B.....68     | 330F1.....64   | 386A.....63       | 88.....66              |
| 153.....68      | 330F2.....64   | 387A.....63       | 880.....86             |
| 154.....68      | 330P.....64    | 389.....63        | 881.....86             |
| 155.....68      | 332A.....64    | 390.....63        | A*F.....46             |
| 15AK15.....45   | 336A.....64    | 41.....68         | A*FB.....46            |

|                   |                   |                    |                     |
|-------------------|-------------------|--------------------|---------------------|
| A*FBAU.....46     | E112BL.....68     | MD15.....45        | MVP32K3*75T.....37  |
| A*FL.....46       | E3FSC.....47      | MD3.....45         | MVP32K3*NT.....37   |
| A*M.....46        | E3FSCB.....47     | MD6.....45         | P*F.....48          |
| A*MB.....46       | E3FSCBAU.....47   | MD334B.....70      | P*FB.....48         |
| A*MBAU.....46     | E3MSC.....47      | MT48FN.....26      | P*M.....48          |
| A*ML.....46       | E3MSCB.....47     | MT48HN.....26      | P*MB.....48         |
| AA*F.....46       | E3MSCBAU.....47   | MT48K1FN.....24    | P2912.....95        |
| AA*FB.....46      | EH13942.....52    | MT48K1HN.....24    | PC142A.....68       |
| AA*FBAU.....46    | EHBNC2.....52     | MT48K1NN.....24    | PD3FSC1.....48      |
| AA*FL.....46      | EHBNCSC.....52    | MT48K1NS.....24    | PD3FSC1AU.....48    |
| AA*M.....46       | EHCAT62.....52    | MT48K3FN.....24    | PD3MSC1.....48      |
| AA*MB.....46      | EHRCA2.....52     | MT48K3HN.....24    | PD3MSC1AU.....48    |
| AA*MBAU.....46    | EHRCABNC.....52   | MT48K3NN.....24    | PL106205.....95     |
| AA*ML.....46      | EHUSB2.....52     | MT48NN.....26      | PL106705.....95     |
| AAA*FBAUZ.....46  | HP75BNC1.....54   | MT48NS.....26      | PL206205.....95     |
| AAA*FBZ.....46    | HP75BNC12.....54  | MT52FN.....26      | PL206705.....95     |
| AAA*FPBAUZ.....46 | HP75BNC2.....54   | MT52HN.....26      | PT1LA.....4         |
| AAA*FPBZ.....46   | HP75BNC7.....54   | MT52K1FN.....24    | PT2B.....4          |
| AAA*FPZ.....46    | HP75BNC9.....54   | MT52K1HN.....24    | QGPK116FB.....32    |
| AAA*FZ.....46     | HPCC4F.....51     | MT52K1NN.....24    | QGPK116MB.....32    |
| AAA*MBAUZ.....46  | HPC4RAF.....51    | MT52K1NS.....24    | QGPK18M8FB.....32   |
| AAA*MBZ.....46    | HPCI4F.....51     | MT52K3FN.....24    | QGPK1B.....32       |
| AAA*MPBAUZ.....46 | HPCP410PC.....50  | MT52K3HN.....24    | QGPK332MFB.....32   |
| AAA*MPBZ.....46   | HPCP410RA.....50  | MT52K3NN.....24    | QGPK3B.....32       |
| AAA*MPZ.....46    | HPCP41F.....50    | MT52NN.....26      | R*FBAUZ.....48      |
| AAA*MZ.....46     | HPCP41F1.....50   | MT52NS.....26      | R*FBZ.....48        |
| B*F.....47        | HPCP420PC.....50  | MTP24K7.....18     | R*FZ.....48         |
| B*FB.....47       | HPCP420RA.....50  | MTP48K1NO.....14   | R*MBAUZ.....48      |
| B*M.....47        | HPCP42F.....50    | MTP48K1NS.....14   | R*MBZ.....48        |
| B*MB.....47       | HPCP42F1.....50   | MTP48K3BPNS.....18 | R*MZ.....48         |
| BPJF**.....70     | HPCPK112F.....30  | MTP48K3NO.....14   | RA49B11.....66      |
| BPJF**AU.....70   | HPCPK112F1.....30 | MTP48K3NS.....14   | RA49C14B.....66     |
| BPJJ**.....70     | HPCPK1B.....30    | MTP48K3PBNO.....18 | RN112APC.....66     |
| BPJJ**AU.....70   | HPCPK324F.....30  | MTP48K3SNO.....14  | RS422H48N081.....12 |
| BPJR**.....70     | HPCPK324F1.....30 | MTP52K3BPNO.....18 | RS422H4N161.....12  |
| BPJR**AU.....70   | HPCPK3B.....30    | MTPFA48K1NO.....8  | RS422H4N162.....12  |
| C*F.....47        | HPCPR410PC.....50 | MTPFA48K1NS.....8  | RS422H4N242.....12  |
| C*FB.....47       | HPCPR41F.....50   | MTPH48K1NO.....5   | RS422V4N081.....12  |
| C*M.....47        | HPCPR41F1.....50  | MTPH48K1NS.....5   | RS422V4N161.....12  |
| C*MB.....47       | HPCPR420PC.....50 | MTPH48K3NO.....5   | RS422V4N162.....12  |
| D*F.....47        | HPCPR42F.....50   | MTPH48K3NS.....5   | RS422V4N242.....12  |
| D*FB.....47       | HPCPR42F1.....50  | MTPH48K3SNO.....5  | RS422V4N322.....12  |
| D*FBAU.....47     | J3FS.....48       | MVEZNPk175T.....42 | S3F5M.....63        |
| D*FS.....47       | K131.....95       | MVJ*75T.....39     | S3FM.....63         |
| D*M.....47        | K3FS.....48       | MVJ*NT.....39      | S5F3M.....63        |
| D*MB.....47       | K459.....4        | MVP32K1*75T.....37 | S760.....71         |
| D*MBAU.....47     | K460.....4        | MVP32K1*NT.....37  | S760K.....71        |
| D*MS.....47       | MBPK175T.....43   | MVP32K2*75T.....37 | S765.....71         |
| E111L.....68      | MD10.....45       | MVP32K2*NT.....37  | T127410.....95      |

# INDEX

|            |    |               |    |               |    |
|------------|----|---------------|----|---------------|----|
| T12742     | 95 | TTD8          | 45 | VPP24K3HD*75T | 34 |
| T12745     | 95 | TTD9          | 45 | VPP24K3HD*NT  | 34 |
| T3F        | 48 | TTEZN***0     | 10 | VPP24K3SD*75T | 34 |
| TA*F       | 49 | TTP96ASFN     | 28 | VPP24K3SD*NT  | 34 |
| TA*FB      | 49 | TTP96ASHN     | 28 | VPP26K1HD*75T | 34 |
| TA*FL      | 49 | TTP96ASNN     | 28 | VPP26K1HD*NT  | 34 |
| TA*M       | 49 | TTP96K1FN     | 22 | VPP26K1SD*75T | 34 |
| TA*MB      | 49 | TTP96K1HN     | 22 | VPP26K1SD*NT  | 34 |
| TA*ML      | 49 | TTP96K1NN     | 22 | VPP26K3HD*75T | 34 |
| TA01       | 63 | TTP96K3BPNS   | 18 | VPP26K3HD*NT  | 34 |
| TA02       | 63 | TTP96K3FN     | 22 | VPP26K3SD*75T | 34 |
| TA04       | 63 | TTP96K3HNN    | 22 | VPP26K3SD*NT  | 34 |
| TA05       | 63 | TTP96K3NN     | 22 | VSPP          | 44 |
| TB*M       | 49 | TTP96K5BPNS   | 18 | WMT334B       | 70 |
| TB*MB      | 49 | TTPFA96K1NO   | 8  | WTT34B        | 70 |
| TT1        | 45 | TTPFA96K1NS   | 8  | YMT334BN      | 70 |
| TT10       | 45 | TTPH96K1NO    | 5  | Z15J          | 66 |
| TT122      | 45 | TTPH96K1NS    | 5  |               |    |
| TT124      | 45 | TTPH96K3NO    | 5  |               |    |
| TT126      | 45 | TTPH96K3NS    | 5  |               |    |
| TT127      | 45 | TTPW96K1HN    | 16 |               |    |
| TT128      | 45 | TTPW96K1NN    | 16 |               |    |
| TT2        | 45 | TTPW96K1NS    | 16 |               |    |
| TT253      | 87 | TTPW96K3HNN   | 16 |               |    |
| TT253N     | 87 | TTPW96K3NN    | 16 |               |    |
| TT253NC    | 87 | TTPW96K3NS    | 16 |               |    |
| TT254      | 87 | TY*F          | 49 |               |    |
| TT254N     | 87 | VAPK1HD*75T   | 40 |               |    |
| TT254NC    | 87 | VAPK1HD*NT    | 40 |               |    |
| TT3        | 45 | VAPK1SD*75T   | 40 |               |    |
| TT34B      | 70 | VAPK1SD*NT    | 40 |               |    |
| TT34BN     | 81 | VAPK3HD*75T   | 40 |               |    |
| TT34BNY    | 70 | VAPK3HD*NT    | 40 |               |    |
| TT4        | 45 | VAPK3SD*75T   | 40 |               |    |
| TT5        | 45 | VAPK3SD*NT    | 40 |               |    |
| TT6        | 45 | VJHD*75TX     | 36 |               |    |
| TT7        | 45 | VJHD*NTX      | 36 |               |    |
| TT8        | 45 | VJSD*75TX     | 36 |               |    |
| TT9        | 45 | VJSD*NTX      | 36 |               |    |
| TT96EDACNO | 20 | VMAFN         | 40 |               |    |
| TT96EDACNS | 20 | VMPP          | 44 |               |    |
| TTD1       | 45 | VMVHD*75T     | 40 |               |    |
| TTD10      | 45 | VMVHD*NT      | 40 |               |    |
| TTD2       | 45 | VMVSD*75T     | 40 |               |    |
| TTD3       | 45 | VMVSD*NT      | 40 |               |    |
| TTD4       | 45 | VPP24K1HD*75T | 34 |               |    |
| TTD5       | 45 | VPP24K1HD*NT  | 34 |               |    |
| TTD6       | 45 | VPP24K1SD*75T | 34 |               |    |
| TTD7       | 45 | VPP24K1SD*NT  | 34 |               |    |

# Switel

## Данный компонент на территории Российской Федерации

### Вы можете приобрести в компании MosChip.

Для оперативного оформления запроса Вам необходимо перейти по данной ссылке:

<http://moschip.ru/get-element>

Вы можете разместить у нас заказ для любого Вашего проекта, будь то серийное производство или разработка единичного прибора.

В нашем ассортименте представлены ведущие мировые производители активных и пассивных электронных компонентов.

Нашей специализацией является поставка электронной компонентной базы двойного назначения, продукции таких производителей как XILINX, Intel (ex.ALTERA), Vicor, Microchip, Texas Instruments, Analog Devices, Mini-Circuits, Amphenol, Glenair.

Сотрудничество с глобальными дистрибьюторами электронных компонентов, предоставляет возможность заказывать и получать с международных складов практически любой перечень компонентов в оптимальные для Вас сроки.

На всех этапах разработки и производства наши партнеры могут получить квалифицированную поддержку опытных инженеров.

Система менеджмента качества компании отвечает требованиям в соответствии с ГОСТ Р ИСО 9001, ГОСТ РВ 0015-002 и ЭС РД 009

### Офис по работе с юридическими лицами:

105318, г.Москва, ул.Щербаковская д.3, офис 1107, 1118, ДЦ «Щербаковский»

Телефон: +7 495 668-12-70 (многоканальный)

Факс: +7 495 668-12-70 (доб.304)

E-mail: [info@moschip.ru](mailto:info@moschip.ru)

Skype отдела продаж:

moschip.ru

moschip.ru\_4

moschip.ru\_6

moschip.ru\_9