

COMPACT POWER RELAY

1 POLE X 2—12A (28VDC) (FOR 24V BATTERY AUTOMOTIVE APPLICATIONS)

FBR572, 582 SERIES

■ FEATURES

- Two independent relays mounted in a single package (43% of the volume of the two FRL-270 relays)
- High current contact capacity (carrying current: 40 A/2 minutes, 30 A/1 hour)
- Suitable for controlling 24 V motors in trucks and other large vehicles
- High heat resistance and extended operating voltage
- Two types of contact gap (FBR572: 0.8 mm, FBR582: 1.4 mm)



■ ORDERING INFORMATION

[Example] $\frac{\text{FBR572}}{\text{(a)}} \frac{\text{N}}{\text{(b)}} \frac{\text{D24}}{\text{(c)}} - \frac{\text{W}}{\text{(d)}} \frac{\text{**}}{\text{(e)}}$

(a)	Series Name	FBR572: FBR572 Series relay (contact gap 0.8 mm) FBR582: FBR582 Series relay (contact gap 1.4 mm)
(b)	Structure	N : Plastic sealed type
(c)	Nominal Voltage	D24 : 24 VDC
(d)	Contact Material	W : Silver-tin oxide indium Y : Silver-tin oxide N : Silver copper nickel
(e)	Custom Designation	To be assigned custom specification

FBR572, 582 SERIES

■ SPECIFICATIONS

Item		FBR570 Series	FBR580 Series
Contact	Arrangement	1 form C × 2 (SPDT × 2)	
	Material	Silver-tin oxide indium (-W type) Silver copper nickel (-N type)	Silver-tin oxide indium (-W type) Silver-tin oxide (-Y type)
	Voltage Drop (Resistance)	Maximum 100 mV (at 12 VDC 2 A)	
	Ratings	28 VDC 12 A (locked motor load) 28 VDC inrush 15 A, break 2.5 A (motor free load)	
	Maximum Carrying Current	40 A/2 minutes, 30 A/ 1 hour (25°C, 100% rated coil voltage)	
	Maximum Inrush Current (Reference)	-W,-Y type: 60 A -N type: 40 A	
	Max. Switching Current (Reference)	12 A 28 VDC	14 A 32 VDC
	Minimum Switching Load* ¹ (Reference)	-W, -Y Type: 6 VDC 1 A -N Type: 6 VDC 2 A	
Coil	Operating Temperature	-40°C to +85°C (no frost)	
	Storage Temperature	-40°C to +100°C (no frost)	
Time Value	Operate (at nominal voltage)	Maximum 10 ms	
	Release (at nominal voltage)	Maximum 5 ms	
Life	Mechanical	1 × 10 ⁷ operations minimum	1 × 10 ⁶ operations minimum
	Electrical	1 × 10 ⁵ operations minimum (locked motor load) 5 × 10 ⁵ operations minimum (motor free load)	1 × 10 ⁵ operations minimum (locked motor load)
Other	Vibration Resistance	10 to 55 Hz (double amplitude of 1.5 mm)	
	Shock Resistance	Misoperation	100 m/s ²
		Endurance	1,000 m/s ²
	Weight	Approximately 18 g	

*1 Values when switching a resistive load at normal room temperature and humidity, and in a clean environment. The minimum switching load varies with the switching frequency and operating environment.

■ COIL DATA CHART

ORDERING CODE	Rated coil voltage	Coil resistance (±10%)	Must operate voltage	Thermal resistance
FBR572ND24-W FBR572ND24-N	24 VDC	384 Ω	14.4 VDC (at 20°C)	67°C/W
FBR582ND24-W FBR582ND24-Y		170 Ω	18.0 VDC (at 85°C)	56°C/W

FBR572, 582 SERIES

■ SUITABLE APPLICATIONS

Application	Normal load current	Life x 10 ³	Recommended model (example)
Power Windows	10 to 12 A (switching at motor locking)	100	FBR572ND24-W
Automatic Door Lock	5 A/2 door (switching at motor locking)	100	FBR572ND24-W
Intermittent Wipers	INRUSH 15 to 30 A BREAK 2 to 8 (motor free)	300	FBR572ND24-W
			FBR572ND24-N

■ CHARACTERISTIC DATA

1. MAXIMUM BREAK CAPACITY

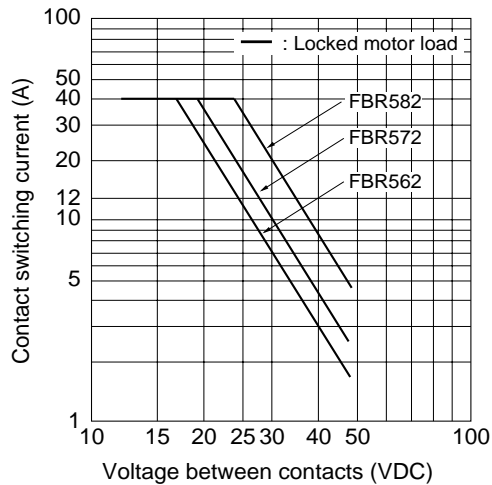

• Test circuit

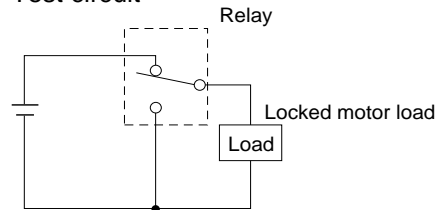

FBR572, 582 SERIES

2. LIFE TEST (EXAMPLE)

[FBR572 type]

- Test item
28 VDC-12 A
Motor lock
100,000 operations minimum
(FBR572 □-W type)

- Test circuit

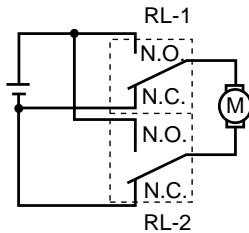

- Current wave form

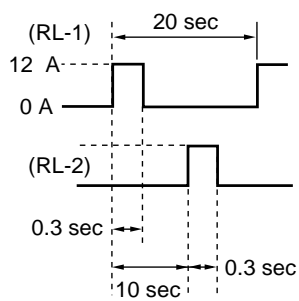

- Shift of pick-up drop-out voltage

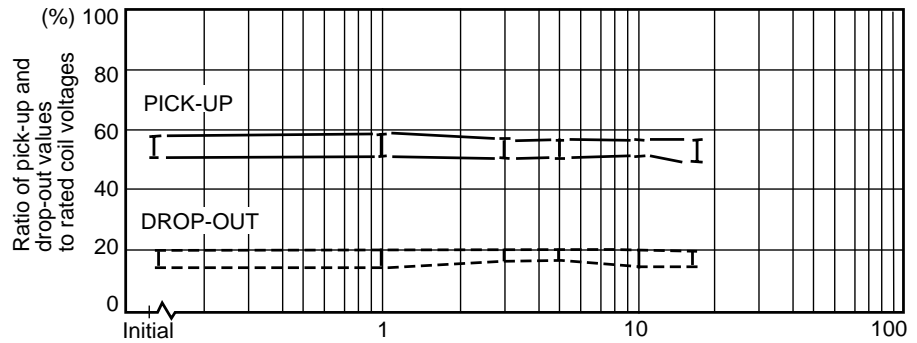

- Shift of contact resistance

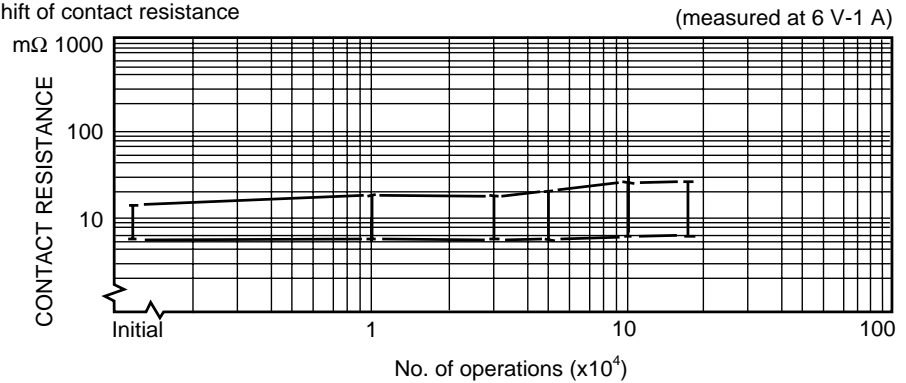

[FBR582 type]

- Test item
28 VDC-12 A
Motor lock
100,000 operations minimum
(FBR582 □-W type)

- Test circuit

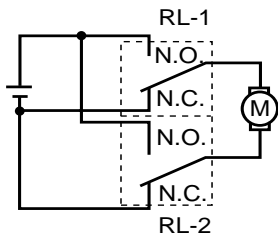

- Current wave form

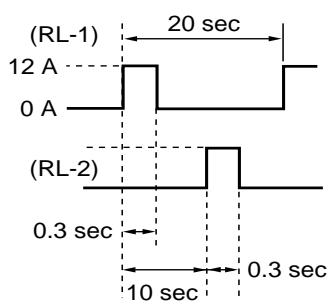

- Shift of pick-up drop-out voltage

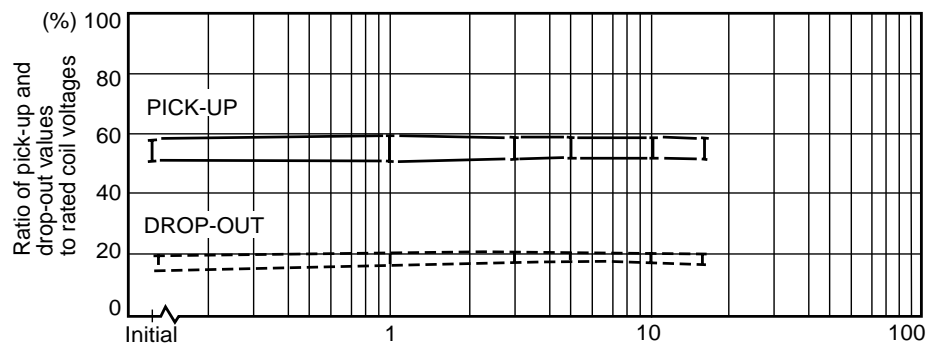

- Shift of contact resistance

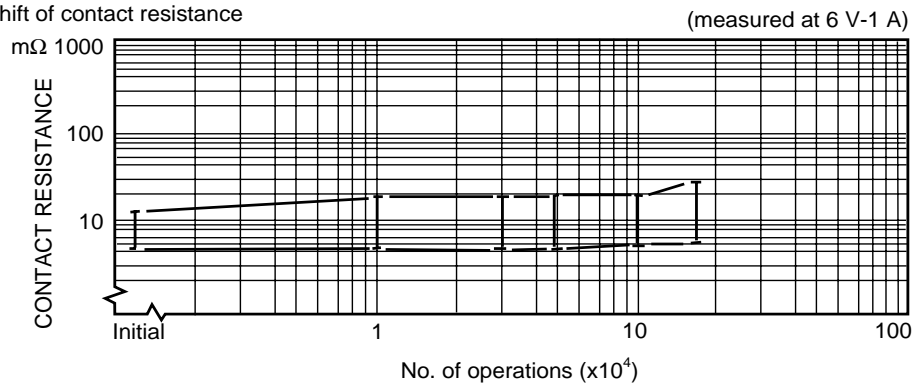

FBR572, 582 SERIES

3. OPERATING COIL VOLTAGE RANGE

[FBR572 type]

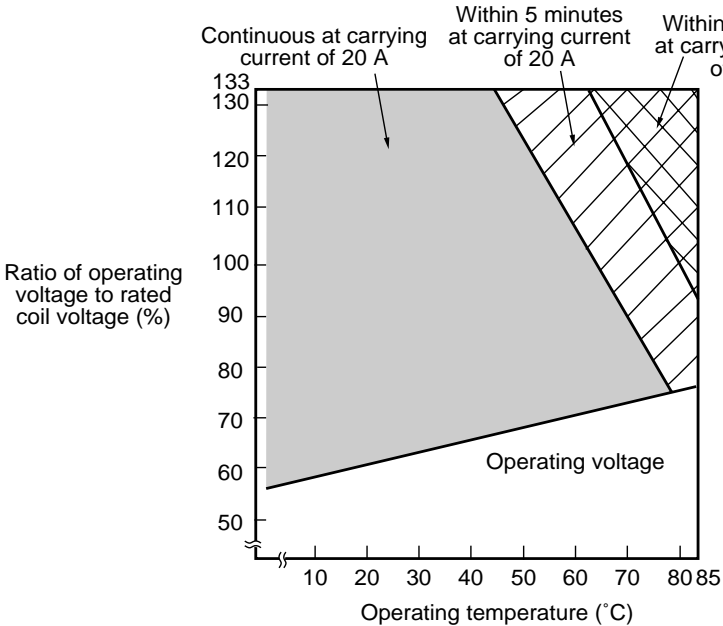

[FBR582 type]

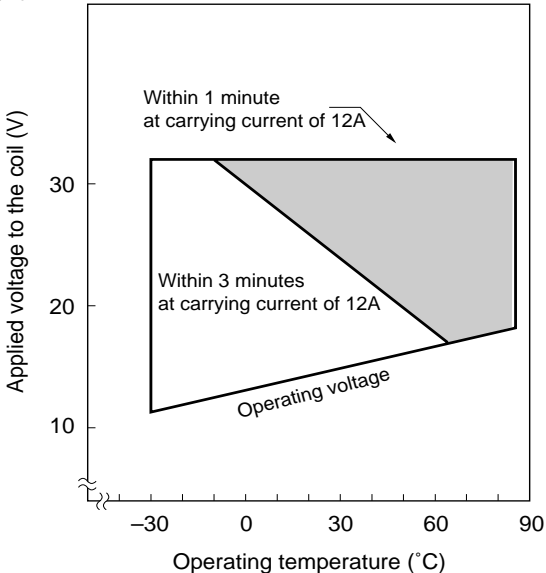

4. VIBRATION RESISTANCE CHARACTERISTICS

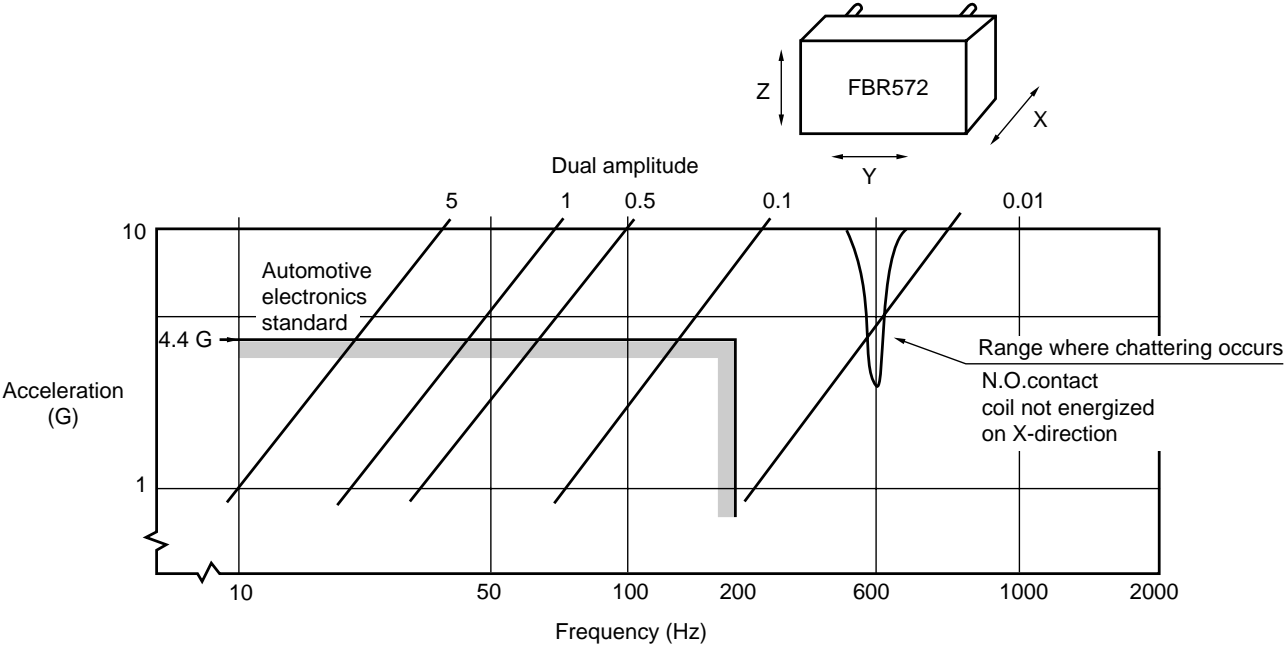

FBR572, 582 SERIES

5. SHOCK RESISTANCE CHARACTERISTICS

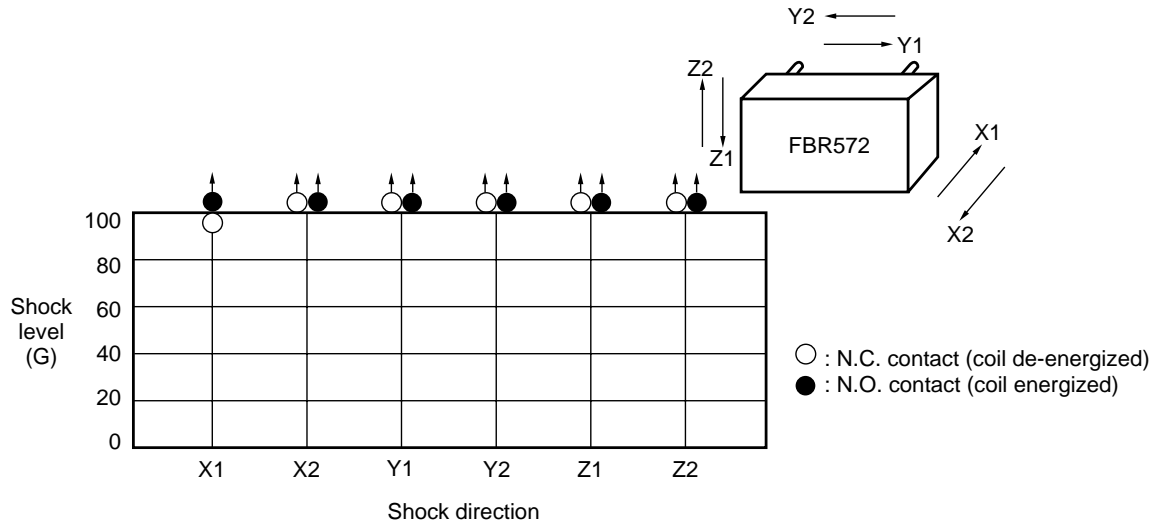

■ REFERENCE DATA

[FBR572 type]

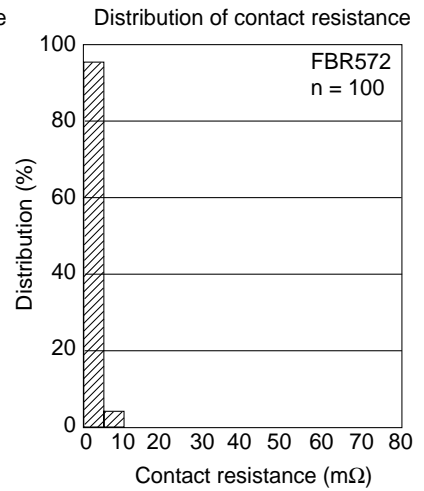
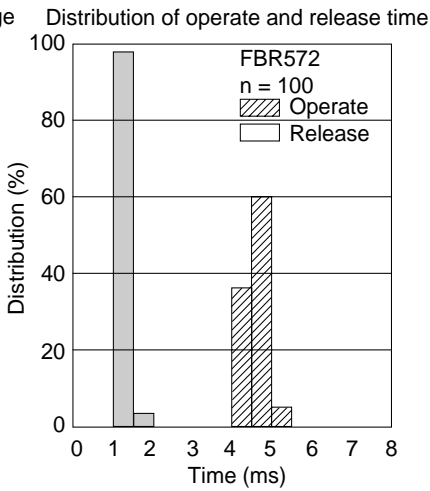
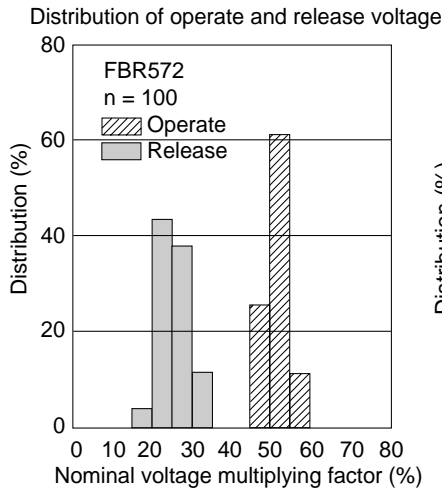

[FBR582 type]

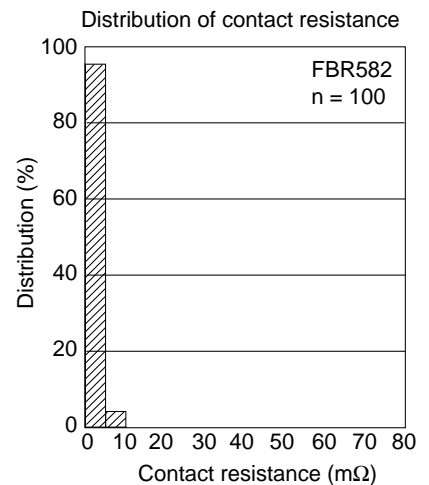
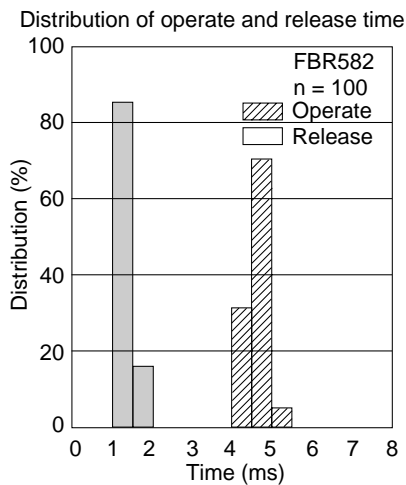
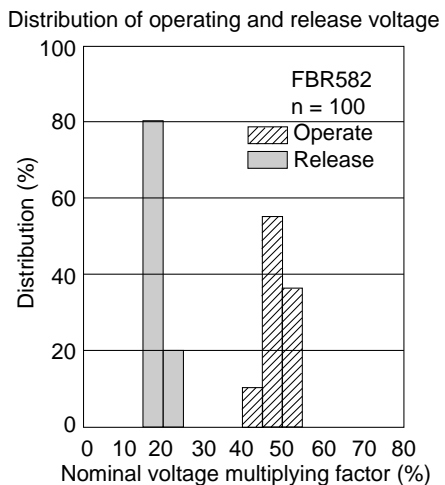

FBR572, 582 SERIES

■ DIMENSIONS

[FBR572 type]

● Dimensions

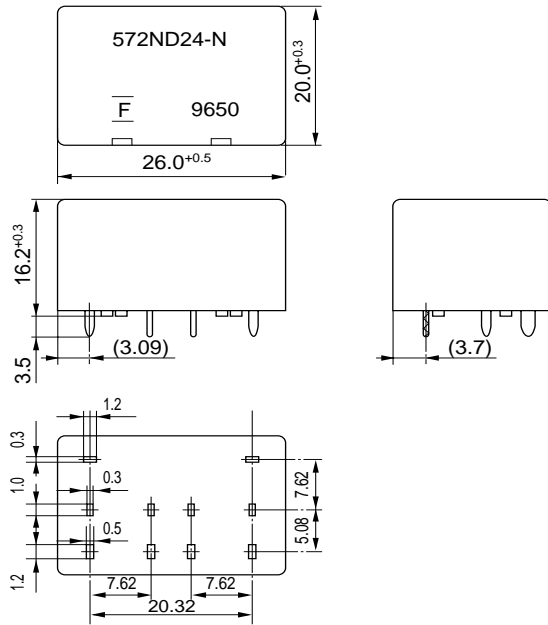

● PC board mounting hole layout (BOTTOM VIEW)

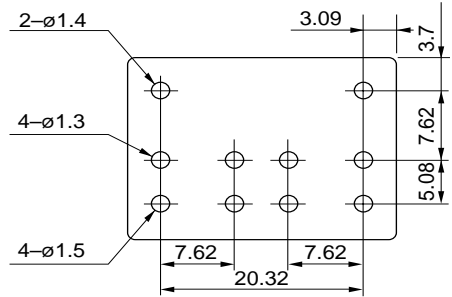

● Schematic (BOTTOM VIEW)

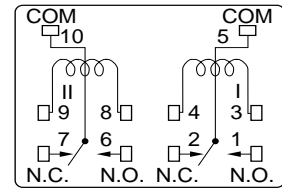

● Tube carrier

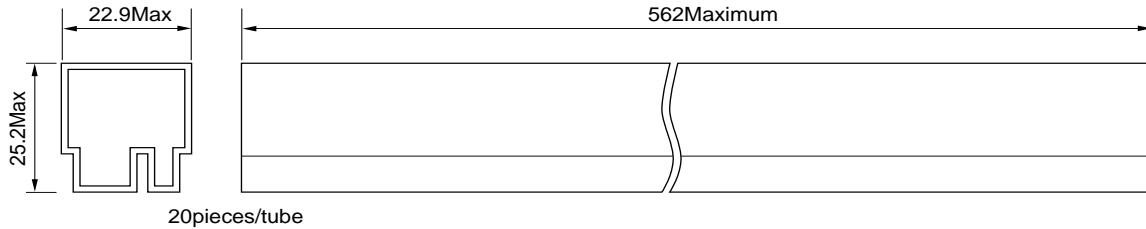

Unit: mm

FBR572, 582 SERIES

■ DIMENSIONS

[FBR582 type]

● Dimension

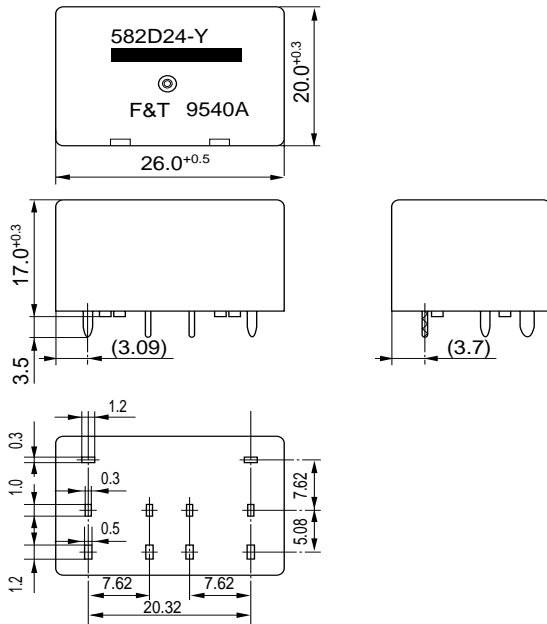

● PC board mounting hole layout (BOTTOM VIEW)

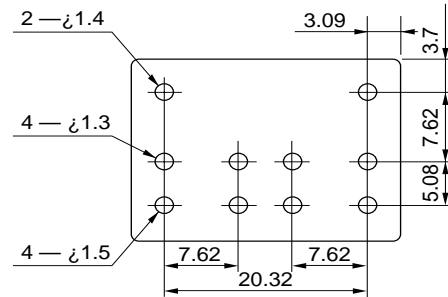

● Schematic (BOTTOM VIEW)

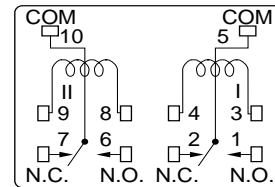

● Tube carrier

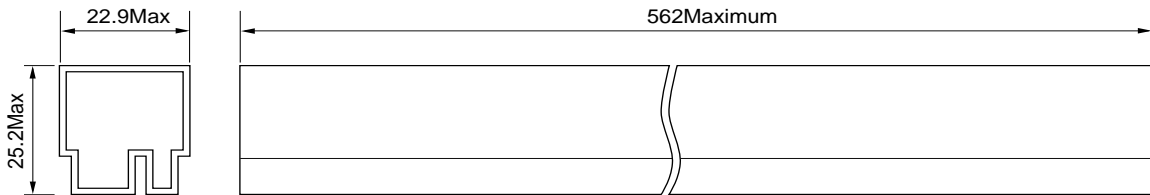

20pieces/tube

Unit: mm

Fujitsu Components International Headquarter Offices

Japan

Fujitsu Component Limited
Gotanda-Chuo Building
3-5, Higashigotanda 2-chome, Shinagawa-ku
Tokyo 141, Japan
Tel: (81-3) 5449-7010
Fax: (81-3) 5449-2626
Email: promothq@ft.ed.fujitsu.com
Web: www.fcl.fujitsu.com

North and South America

Fujitsu Components America, Inc.
250 E. Caribbean Drive
Sunnyvale, CA 94089 U.S.A.
Tel: (1-408) 745-4900
Fax: (1-408) 745-4970
Email: marcom@fcai.fujitsu.com
Web: www.fcai.fujitsu.com

Europe

Fujitsu Components Europe B.V.
Diamantlaan 25
2132 WV Hoofddorp
Netherlands
Tel: (31-23) 5560910
Fax: (31-23) 5560950
Email: info@fceu.fujitsu.com
Web: www.fceu.fujitsu.com

Asia Pacific

Fujitsu Components Asia Ltd.
102E Pasir Panjang Road
#04-01 Citilink Warehouse Complex
Singapore 118529
Tel: (65) 6375-8560
Fax: (65) 6273-3021
Email: fcal@fcal.fujitsu.com
Web: www.fcal.fujitsu.com

Данный компонент на территории Российской Федерации

Вы можете приобрести в компании MosChip.

Для оперативного оформления запроса Вам необходимо перейти по данной ссылке:

<http://moschip.ru/get-element>

Вы можете разместить у нас заказ для любого Вашего проекта, будь то серийное производство или разработка единичного прибора.

В нашем ассортименте представлены ведущие мировые производители активных и пассивных электронных компонентов.

Нашей специализацией является поставка электронной компонентной базы двойного назначения, продукции таких производителей как XILINX, Intel (ex.ALTERA), Vicor, Microchip, Texas Instruments, Analog Devices, Mini-Circuits, Amphenol, Glenair.

Сотрудничество с глобальными дистрибьюторами электронных компонентов, предоставляет возможность заказывать и получать с международных складов практически любой перечень компонентов в оптимальные для Вас сроки.

На всех этапах разработки и производства наши партнеры могут получить квалифицированную поддержку опытных инженеров.

Система менеджмента качества компании отвечает требованиям в соответствии с ГОСТ Р ИСО 9001, ГОСТ РВ 0015-002 и ЭС РД 009

Офис по работе с юридическими лицами:

105318, г.Москва, ул.Щербаковская д.3, офис 1107, 1118, ДЦ «Щербаковский»

Телефон: +7 495 668-12-70 (многоканальный)

Факс: +7 495 668-12-70 (доб.304)

E-mail: info@moschip.ru

Skype отдела продаж:

moschip.ru

moschip.ru_4

moschip.ru_6

moschip.ru_9