

ACTIVE BIAS CONTROLLER

Typical Applications

- Microwave Radio & VSAT
- Military & Space
- Test Instrumentation
- Fiber Optic Modulator Driver Biasing
- CATV Laser Driver Biasing
- Cellular Base Station
- Wireless Infrastructure Equipment

Features

- Automatic Gate voltage adjustment (No Calibration required)
- Supply Voltage: 4V to 12V
- Digital Voltage: 3.3V to 5V
- Controls both Enhancement and Depletion type devices
- Adjustable Drain Current up to 200mA
- Sink/Source Gate Current Capability
- Optional Internal negative voltage generation that can be disabled to use external negative rail
- Fast Enable/Disable
- Trigger-out Output for Daisy Chain Power-Up and Power-Down Sequencing

Functional Diagram

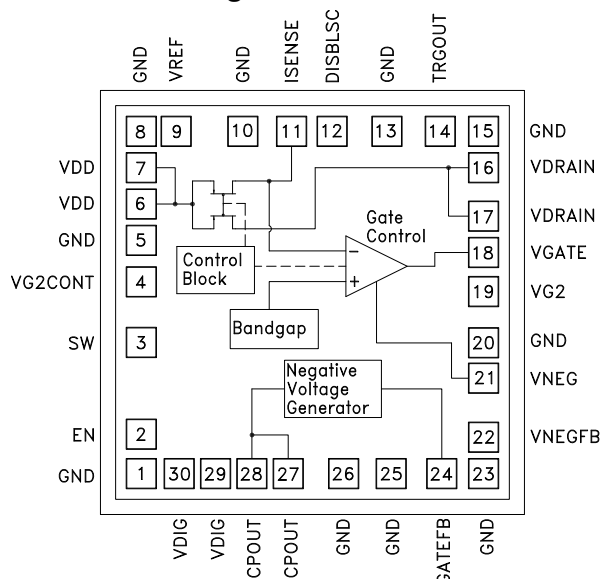

General Description

HMC981 is an active bias controller that automatically adjusts the gate voltage of an external amplifier to achieve constant bias current. It can be used to bias any enhancement and depletion type amplifiers operating in Class-A regime with Drain voltages from 4V to 12V and drain currents up to 200mA, offering a complete biasing solution.

HMC981 achieves excellent bias stability over supply, temperature and process variations, and eliminates the required calibration procedures usually employed to prevent RF performance degradation due to such variations.

All data shown herein is taken with appropriate probes.

ACTIVE BIAS CONTROLLER
Electrical Specifications, $T_A = +25^\circ\text{C}$, $V_{DD}=8\text{V}$, $V_{DIG}= 3.3\text{V}$, Depletion Master
Unless Otherwise Noted

Parameter	Symbol	Conditions	Min.	Typ.	Max.	Units
Supply Voltage	Vdd		4		12	V
VDD Quiescent Current	IDD	VDD = 4V	EN = VDIG	7		mA
			EN = GND	3		mA
		VDD = 8V	EN = VDIG	7.5		mA
			EN = GND	4		mA
VDIG Quiescent Current	IDIG	VDIG= 3.3 V		3		mA
		VDIG= 5 V		5		mA
Negative Voltage Output	VNEG			-2.5		V
Oscillator Frequency	FOSC			300		kHz
Voltage Reference	VREF			1.42		V
Enable Input Threshold	ENTHRS	Vinlow			1	V
		Vinhigh	1.4			V
Switch Input Threshold	SWTHRS	Vinlow			1	V
		Vinhigh	1.4			V
Short Circuit Disable Input Threshold	DSCTHRS	Vinlow			1	V
		Vinhigh	1.4			V
VDRAIN Characteristics						
DRAIN Current Adjustment Range	IDRAIN	SW=GND	20		80	mA
		SW=VDIG	80		200	mA
DRAIN Current Change Over Digital Voltage	Δ IDRAINV	VDRAIN set to 8V, IDRAIN set to 160 mA		0.4		%/V
DRAIN Current Change Over Temperature				0.02		%/C
DRAIN Range	VDRAIN		4		12	V
VDRAIN Change Over Temperature	Δ VDRAIN	VDRAIN set to 8V, IDRAIN set to 160 mA		1.5		%/C
VNEG Characteristics						
Negative Voltage Output	VNEG			-2.5		V
VNEG Current Sink	INEG	VDD = 4V	0		8	mA
		VDD = 8V	0		15	mA
VGATE Characteristics						
GATE Current Supply	IG		-0.8		0.8	mA
VGATE Low Level	VG_MIN			VNEG		V
VGATE High Level	VG_MAX			VNEG+4.5		V
VG2 Characteristics						
VG2 Current Supply	IG2	VG2<1.5V	-0.1		0.1	mA
		VG2>1.5V	-1		1	mA
VG2 Adjustment Range	VG2		1		VDD-1.3	V
VDIG Characteristics						
Adjustment Range	VDIG		3.3		5	V
VDIG Quiescent Current	IDIG	VDD = 8 V, VDIG=EN =3.3 V		3		mA
SW Characteristics						
Internal Switch Resistance	RDS_ON	SW= GND		10		Ohm
		SW=VDIG		5		Ohm

ACTIVE BIAS CONTROLLER

Load Regulation @ VDD=6V, VDIG=3.3V, SW=GND

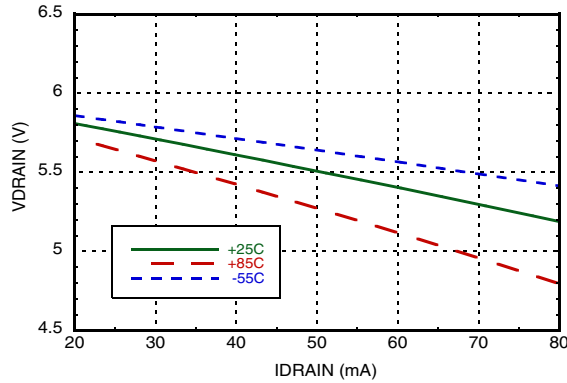

Load Regulation @ VDD=8V, SW=VDIG=3.3V

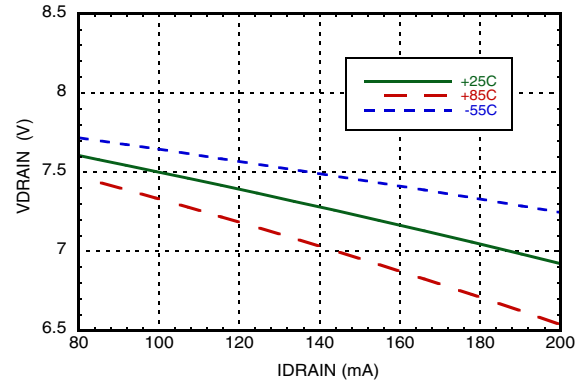

IDRAIN vs. VDIG^{[1][2]}

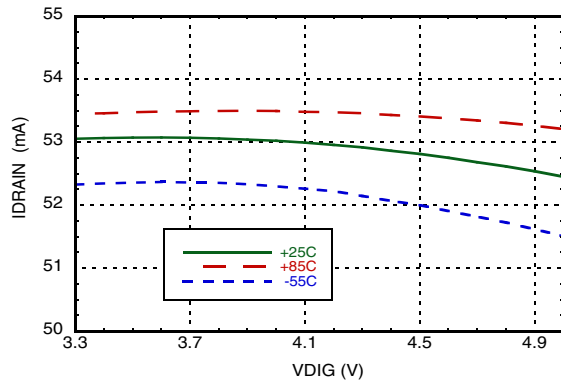

VNEG Line Regulation vs. Supply Voltage

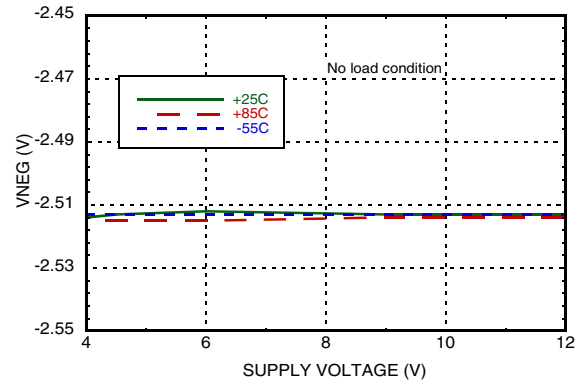

VNEG Load Regulation @ VDD=4V

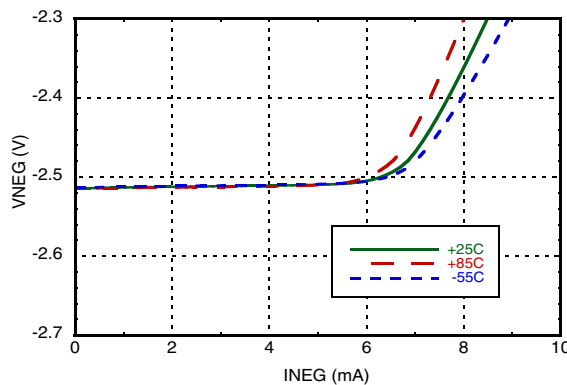

VNEG Load Regulation @ VDD=12V

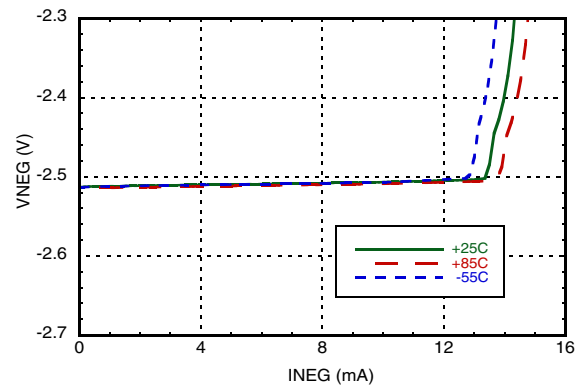

[1] IDRAIN is set to 53 mA

[2] HMC465LP5 is used as external amplifier

ACTIVE BIAS CONTROLLER

Enable Waveform

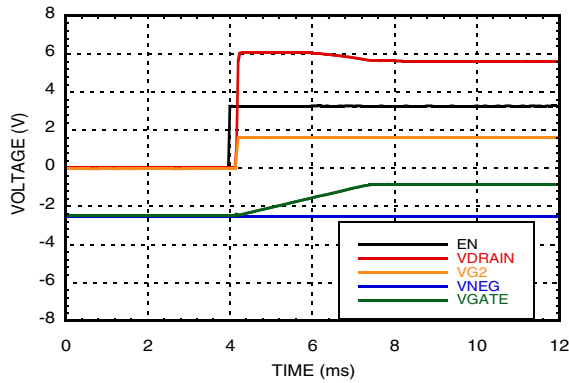

Disable Waveform

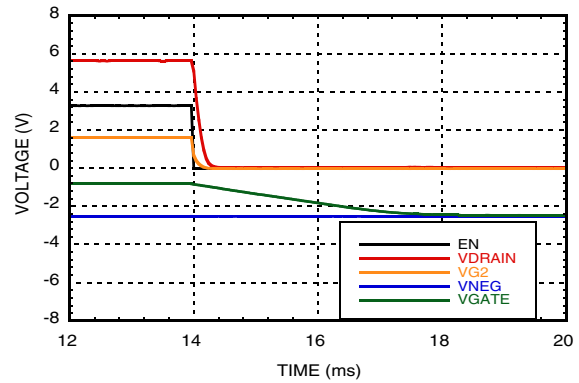

Power Up Waveform

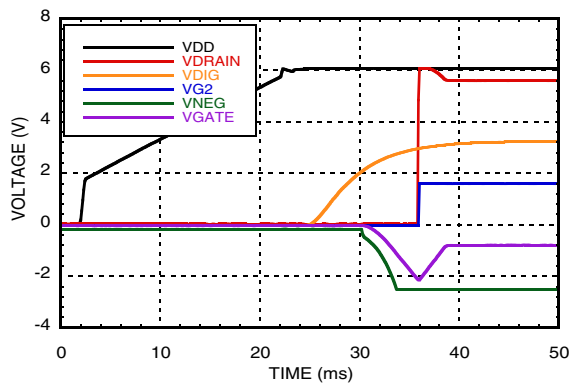

Shutdown Waveform

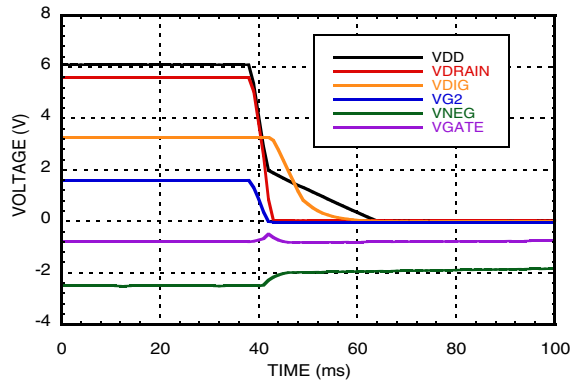

VNEG Load Transient VDD=4V

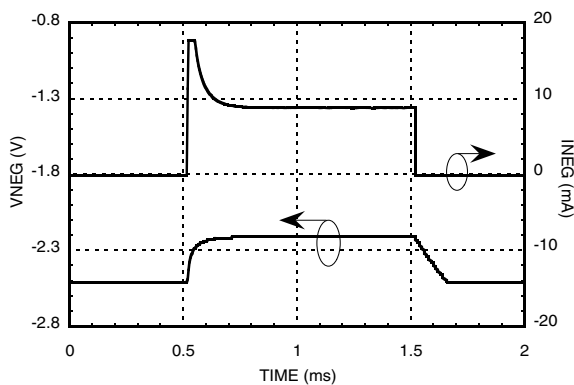

VNEG Load Transient VDD=6V

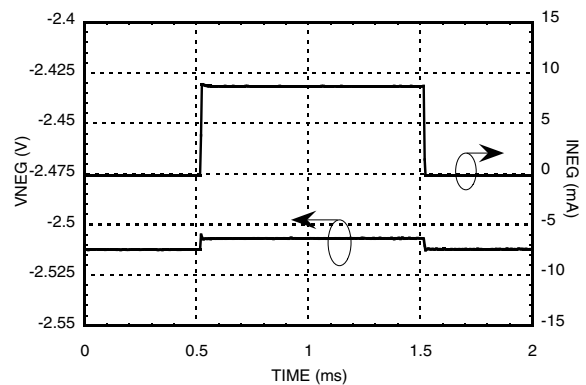

ACTIVE BIAS CONTROLLER

VGATE Load Regulation @ VDD=6V



VG2 Load Regulation @ VDD=6V

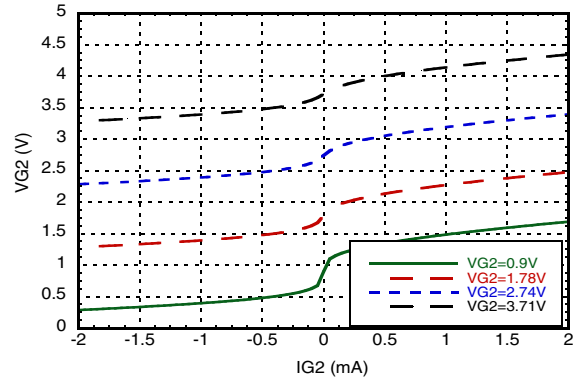

13

BIAS CONTROLLERS - SMT

ACTIVE BIAS CONTROLLER

Absolute Maximum Ratings ^[1]

VDD	12V
VG2_CONT, VDRAIN	-0.5V to VDD + 0.5V
SW, EN, CP_OUT, VGATEFB, VNEGFB, TRIG_OUT, DISBL_SC, ISENSE	-0.5V to VDIG + 0.5V
VDIG	5.5V
VNEG	-4V to GND
VG2	-0.5V to VDD + 0.5V
Junction Temperature	125 °C
Continuous Pdiss (T = 85 °C) (Derate 19.19 mW/°C above 85 °C)	0.77 Watts

Thermal Resistance (R _{TH}) (Junction to package bottom)	52.1 °C/W
Storage Temperature	-65 to +150 °C
Operating Temperature	-55 to +85 °C
ESD Sensitivity (HBM)	Class 1B

Note that there are two different voltage domains on HMC981; a high voltage domain Vdd, and a low voltage domain VDIG. Take necessary precautions not to violate ABS MAX ratings of each subdomains.



**ELECTROSTATIC SENSITIVE DEVICE
OBSERVE HANDLING PRECAUTIONS**

NOTES:

1. ALL DIMENSIONS IN INCHES [MILLIMETERS]
2. DIE THICKNESS IS 0.010 (0.254)
3. TYPICAL BOND PAD IS 0.0039 SQUARE
4. BOND PAD METALLIZATION: ALUMINUM
5. NO BACKSIDE METAL
6. NO CONNECTION REQUIRED FOR UNLABELED BOND PADS
7. OVERALL DIE SIZE IS ±.002

Outline Drawing



For price, delivery, and to place orders, please contact Hittite Microwave Corporation:
2 Elizabeth Drive, Chelmsford, MA 01824 Phone: 978-250-3343 Fax: 978-250-3373
Order On-line at www.hittite.com

ACTIVE BIAS CONTROLLER
Pad Descriptions

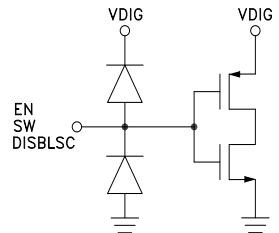
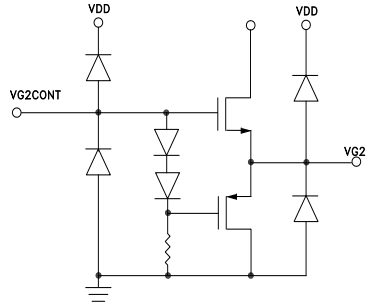
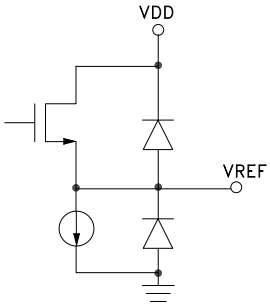
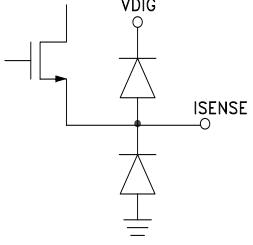
Pad Number	Function	Description	Interface Schematic
1, 5, 8, 10, 13, 15, 20, 23, 25, 26, Die Bottom	GND	These pads and the die bottom must be connected to a high quality RF/DC ground.	
2	EN	Enable pad. System is enabled when Ven is HIGH (VDIG). If left floating, Ven defaults to HIGH (enabled).	
3	SW	Internal switch resistance control pad. If left floating, VSW defaults to HIGH.	
12	DISBLSC	Disables short circuit lock down when pulled to ground. Leave it floating to enable short circuit lock down.	
4	VG2CONT	Control voltage of the VG2. Use a resistor divider between VDD and GND to set the voltage. VG2 is typically 1.3V lower than the VG2CONT	
19	VG2	Second gate control.	
6-7, 29-30	VDD, VDIG	Bias supply pan. Connect supply voltage to this pad with appropriate filtering.	
9	VREF	1.5V reference voltage. 0.1uF or greater capacitor to GND is needed for noise filtering.	
11	ISENSE	To adjust the bias current of the external amplifier connect a resistor (Rsense) from ISENSE pad to GND. Use Eqn.2 to determine the required Rsense value.	

Pad Descriptions (Continued)

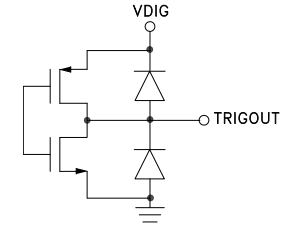
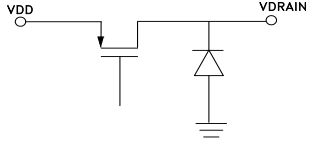
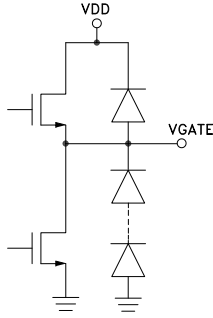
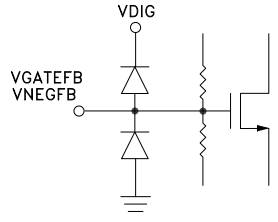
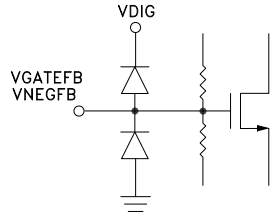
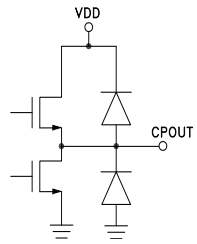
Pad Number	Function	Description	Interface Schematic
14	TRGOUT	Trigger out signal. Generates a HIGH (3.5V) signal when the active bias system stabilizes. This signal can be used to trigger next device (ENABLE) if more than one HMC981 is used in a daisy chain.	
16, 17	VDRAIN	Drain voltage. Should be connected to the supply terminal of the external amplifier. A minimum 100 nF capacitor has to be placed close to the external amplifier to improve load regulation.	
18	VGATE	Gate Control pad for external amplifier. Connect to the gate (base) of the external amplifier. In order to guarantee stability, a 10µF capacitor should be connected between the gate (base) terminal of the external amplifier and GND as close to the amplifier as possible.	
21	VNEG	Negative input to the chip. Should be supplied with CPOUT when negative voltage generator is enabled, or connect to external VSS when negative voltage generator is enabled. For detailed usage please refer to the "Negative Voltage Generator" section.	
22	VNEGFB	Feedback (Control) pad for Negative Voltage Generator Charge Pump. Float to activate the negative voltage generator / Sort to GND to disable the negative voltage generator.	
24	VGATEFB	Control pad for VGATEFB. Float VGATEFB when a depletion mode transistor is biased. Selects the mode of operation along with VNEGFB pad. For detailed usage please refer to the Table 2.	
27, 28	CPOUT	Negative voltage generator charge pump output. Negative voltage generator needs a flying capacitor, a reservoir capacitor and two diodes to operate. Please refer to the application schematic for more info.	

ACTIVE BIAS CONTROLLER

Application Circuit

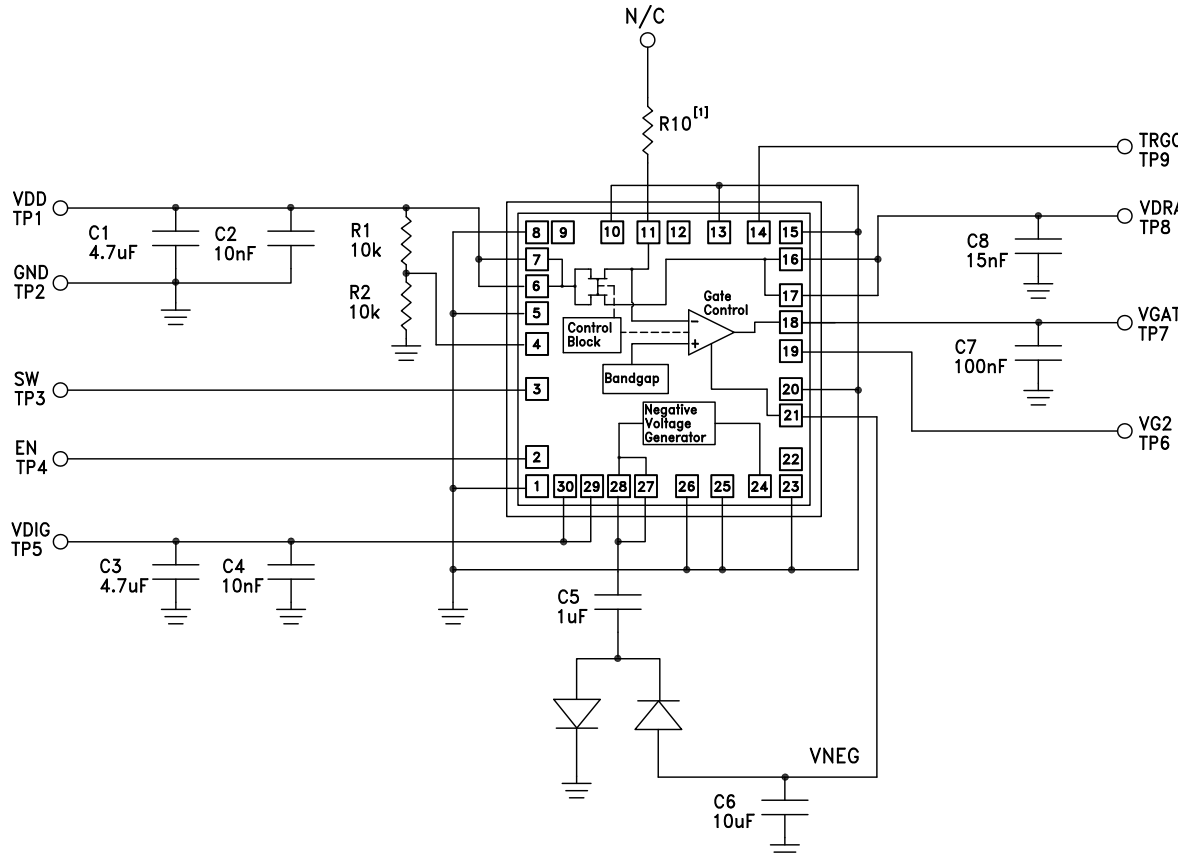

Notes:

[1] Adjust R10 with respect to equation (2).

ACTIVE BIAS CONTROLLER

Mounting & Bonding Techniques for MMICs

The die should be attached directly to the ground plane with epoxy (see HMC general Handling, Mounting, Bonding Note).

Handling Precautions

Follow these precautions to avoid permanent damage.

Storage: All bare die are placed in either Waffle or Gel based ESD protective containers, and then sealed in an ESD protective bag for shipment. Once the sealed ESD protective bag has been opened, all die should be stored in a dry nitrogen environment.

Cleanliness: Handle the chips in a clean environment. DO NOT attempt to clean the chip using liquid cleaning systems.

Static Sensitivity: Follow ESD precautions to protect against ESD strikes.

Transients: Suppress instrument and bias supply transients while bias is applied. Use shielded signal and bias cables to minimize inductive pick-up.

General Handling: The chip may be handled by a vacuum collet or with a sharp pair of tweezers.

Mounting

Epoxy Die Attach: Apply a minimum amount of epoxy to the mounting surface so that a thin epoxy fillet is observed around the perimeter of the chip once it is placed into position. Cure epoxy per the manufacturer's schedule.

Application Notes

Detailed Description

The HMC981 is a fully-integrated Active Bias Controller (ABC) that automatically adjusts the gate voltage of amplifiers operating in the Class-A regime. With an internal feedback the automatic gate voltage control achieves constant quiescent bias through the amplifier under bias, independent of temperature and amplifier threshold variations. The quiescent current is adjusted with a resistor connected externally. The HMC981 employs an integrated control circuitry to achieve safe power-up and power-down sequencing of the targeted amplifier. The HMC981 can provide auto-bias solution virtually any amplifier in the market (both enhancement and depletion type) with a quiescent current of up to 200 mA and a supply voltage of up to 12V.

The HMC981 has an integrated negative voltage generator to synthesize negative voltages required to drive depletion mode amplifiers. If an external negative supply is already available or an enhancement mode device is targeted, the negative voltage generator can be disabled.

The HMC981 achieves excellent bias stability over supply and temperature variations with low supply voltage down to 4V. The gate control can both sink and source current (± 0.8 mA) to achieve constant bias current over input power variations applied to the amplifier. The HMC981 also generates a second gate voltage (VG2). VG2 can be adjusted through a resistor divider connected to VDD for amplifiers which require second gate voltage.

The HMC981 ensures the protection of the external amplifier during turn on/off by adjusting the sequence of VDRAIN, VGATE and VG2 outputs. HMC981 controls the bias current of the amplifier under bias with the gate control driver. The current passing through the amplifier is continuously sampled and is used to control the VGATE voltage connected to the gate of the amplifier.

The HMC981 employs a SW pad to control RDS_ON resistance of the internal switch between VDD and VDRAIN. Refer to the section under the "Supply and Drain Voltage" section for details.

The HMC981 has a built-in short circuit protection feature to protect both itself and the amplifier under bias against short circuit conditions at the VDRAIN output. Refer to the section under the "Short Circuit Protection" section for details.

Digital Power Supply (VDIG)

The HMC981 requires an external low voltage bias rail (3.3V to 5.0V). VDIG powers the internal logic circuitry. VDIG draws an average of 3 mA from a 3.3V. VDIG can accept voltages up to 5.0V.

Supply and Drain Voltage (VDD and VDRAIN)

The VDD supply to the HMC981 is directly connected to the VDRAIN output through an internal MOSFET switch. This internal MOSFET is controlled through power-up sequencing which ensures that no voltage is applied to drain of the external amplifier until the gate voltage is pulled down to VNEG(ensuring external amplifier is pinched-off). The VDRAIN output of the HMC981 should be connected to the drain (collector) of the amplifier under bias for the active bias control feedback and power-up/down sequencing to work.

ACTIVE BIAS CONTROLLER

There will be a voltage drop from VDD to VDRAIN due to finite RDS_ON resistance of the internal switch. To compensate for this voltage drop choose the VDD value as shown in equation (1).

$$VDD = VDRAIN + IDRAIN \times RDS_ON \quad (1)$$

where VDRAIN is the supply voltage of the external amplifier and IDRAIN is the desired constant bias current through the external amplifier.

Note that RDS_ON resistance of the internal FET switch can be adjusted through SW pad. RDS_ON is typically equal to 5 Ohms when SW is pulled up to VDIG, and is typically equal to 10 Ohms when SW is pulled down to GND. If SW is left floating, it is pulled up to VDIG through an internal weak pull-up. Recommended settings for the SW position are given in Table-1. Not using the HMC981 in the recommended settings will increase the power dissipation of the part and may increase the part-to-part variation.

Table 1. Recommended Current Range Configuration

Current Range (mA)	Condition	RDS_ON (Ohm)
20 to 80	SW=GND	10
80 to 200	SW=VDIG	5

Negative Voltage Generator (VNEGOUT)

The HMC981 has an internally regulated charge pump block to generate negative voltage (VNEGOUT) required for depletion mode devices. The HMC981 generates -2.5V at the VNEGOUT output in default configuration. It requires two diodes and two capacitors connected externally as shown in the sample application schematics. The HMC981 is designed to reject the ripple on the VNEGOUT by isolating VNEGOUT from the VGATE. The negative voltage is only required for depletion mode devices, and it can be disabled through the VGATEFB and VNEGFB pads. Where an enhancement device is targeted or a negative supply is already available in the system, simply connect the available negative supply to the VNEG pad. See Table-2 for detail on how to set this operation mode.

Enable/Disable (EN)

The active bias control loop is enabled when EN is pulled up to VDIG, and it is disabled when it is pulled down to GND. If EN is left floating HMC981 is enabled through an internal weak pull-up. Note that VNEG operation is independent of EN condition. EN signal controls the operation of only VGATE, VG2 and VDRAIN outputs. When EN pulled down to GND, the HMC981 discharges VDRAIN and VG2 down to GND and it pulls the VGATE down to VNEG. Please see the "Active Bias Control Loop" section for detailed explanation.

Active Bias Control Loop

The HMC981 regulates the bias current (IDRAIN) of the amplifier under bias through VGATE output connected to the gate of the external amplifier. In this closed loop operation the current passing through the amplifier under bias is sampled and is used to adjust VGATE to achieve constant quiescent bias through the external amplifier.

The HMC981 continuously compensates for any supply, temperature, process variations and threshold drifts due to aging. The part-to-part, temperature, and supply variation of the HMC981 is excellent. Thus, by using an accurate sense resistor connected to the ISENSE pad, expensive calibration procedures in high volume production could be avoided.

ACTIVE BIAS CONTROLLER

The gate control of the HMC981 is designed to both sink and source current in to the gate of the targeted amplifier (at least ± 0.8 mA). This unique feature is important to achieve nearly constant quiescent bias through the amplifier under varying gate current at different input power values.

The bias current passing through the external amplifier can be adjusted with RSENSE, where RSENSE is the R10 connected from ISENSE to GND. Use the relation given in equation (2) to set the desired bias current through the external amplifier.

$$IDRAIN = 32 / R_{sense} \text{ (A)} \quad (2)$$

Self Protection Feature

Due to the small resistance of the internal switch FET a large amount of current may flow through the HMC981. HMC981 limits the maximum current to protect itself under such fault conditions, by turning off VDRAIN and VGATE.

The HMC981 will remain in this protection mode until a full power-cycle or enable/disable cycle is applied.

VNEG Fault Detection Feature

In depletion mode operation VNEG is continuously monitored against short circuit fault to GND. If VNEG rises above a preset value (typically -1V) the system and the external amplifier are disabled by pulling VDRAIN and VG2 to GND and VGATE to VNEG. The system will stay in this stand-by mode until short fault at VNEG is fixed.

Power-up and Enable Sequencing

To ensure the protection of the external amplifier, the HMC981 provides a power-up sequence for enabling active bias control loop. During start-up VDRAIN and VG2 are kept at GND while VGATE is taken to the most negative supply available (VGATE=VNEG). This ensures that external amplifier is completely pinched-off before VDRAIN is applied. When EN signal is received, VDRAIN is applied and the active bias loop is enabled. After the VDRAIN is applied, VG2 is generated. The final phase of the power-up sequence is completed by increasing the VGATE linearly until the set IDRAIN value is achieved.

For power-down and disabling the same sequencing is applied in the reverse order.

Daisy-Chain Operation

HMC981 produces a trigger out signal (TRIGOUT pad#13) when VDRAIN output is enabled. This trigger signal can be used to enable additional HMC981 chips in a chain of amplifiers. The triggering sequence can be routed in any way, from input to output, or from output to input depending on the use. Figure-1 presents a sample use of three HMC981s in an amplification chain. Please note that, only one of the HMC981 is used to generate the negative voltage and the remaining HMC981 is set to receive external negative voltage (which is provided from the master HMC981). Generating negative voltage from a single HMC981 reduces the number of the components in the system, and decreases the overall current consumption..

Please note that, to ensure proper start-up, the system enable signal should be applied to the chip that has the negative voltage generator.

ACTIVE BIAS CONTROLLER



Figure 1. Daisy Chain Operation

Operation Modes

HMC981 can be configured to bias both enhancement and depletion mode external amplifiers. The mode of operation can be selected by setting two pads (VNEGFB, VGATEFB) as tabulated in Table-2. The connection to the VNEGIN should be adjusted accordingly.

In order not to bias external amplifier in a wrong region, please make sure that the correct mode of operation is selected before powering up the HMC981.

The HMC981 does not allow the internal negative voltage generator to work if an enhancement mode is selected. Therefore, if VNEGFB is left floating while VGATEFB is grounded, HMC981 will stay in standby mode.

Please note that the external negative voltage should be between -2.5V to -3.5V for HMC981 to operate. If your application requires negative voltages outside this range please contact Hittite application support.

Table 2 - Mode Selection

	VNEGFB	VGATEFB	VNEGIN	Description
MODE1 (Depletion/Master Mode)	FLOAT	FLOAT	Connected to VNEGOUT	Depletion mode transistor. Internal negative voltage generator is active and generates -2.5V. Sample application schematic given shown in Fig.2a.
MODE2 (Depletion/Slave Mode)	GND	FLOAT	Connected to External VSS	Depletion mode transistor. Internal negative voltage generator is disabled. An external negative voltage less than -2.3V should be connected to VNEGIN. Sample application schematic given shown in Fig.2b.
---	FLOAT	GND	N/A	Not allowed. HMC981 stays in standby.
MODE3 (Enhancement Mode)	GND	GND	Connected to GND	Enhancement mode transistor. Internal negative voltage generator is disabled. Sample application schematic given shown in Fig.2c.

ACTIVE BIAS CONTROLLER



Figure 2a. Depletion/Master Mode Amplifier Typical Application Circuit (Mode 1)

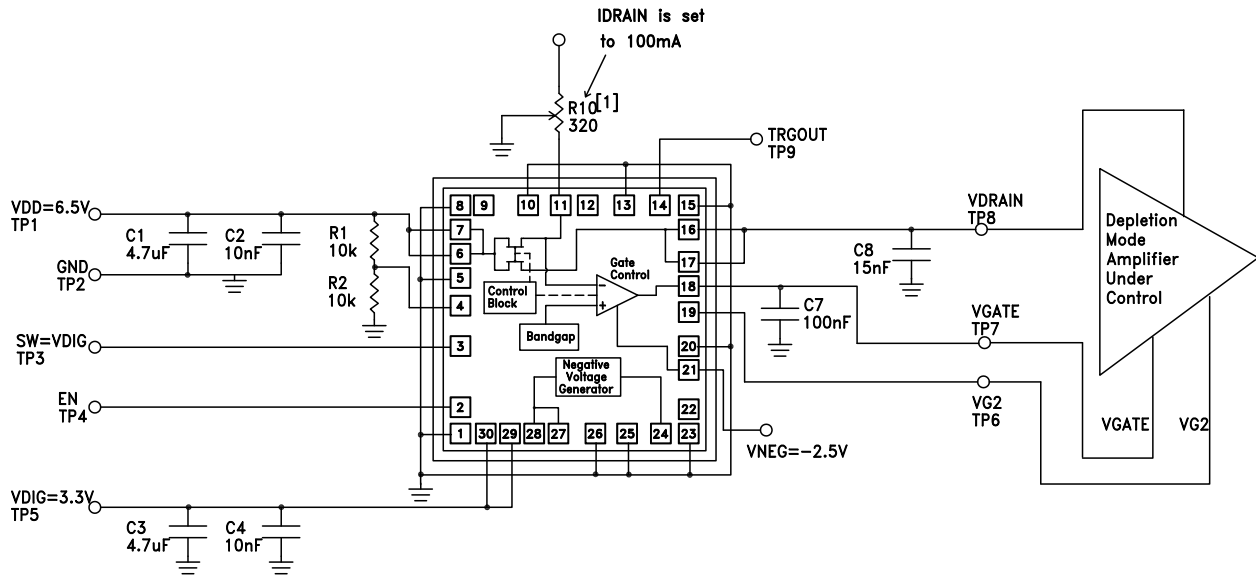

Figure 2b. Depletion/Slave Mode Amplifier Typical Application Circuit (Mode 2)

For price, delivery, and to place orders, please contact Hittite Microwave Corporation:
2 Elizabeth Drive, Chelmsford, MA 01824 Phone: 978-250-3343 Fax: 978-250-3373
Order On-line at www.hittite.com

ACTIVE BIAS CONTROLLER

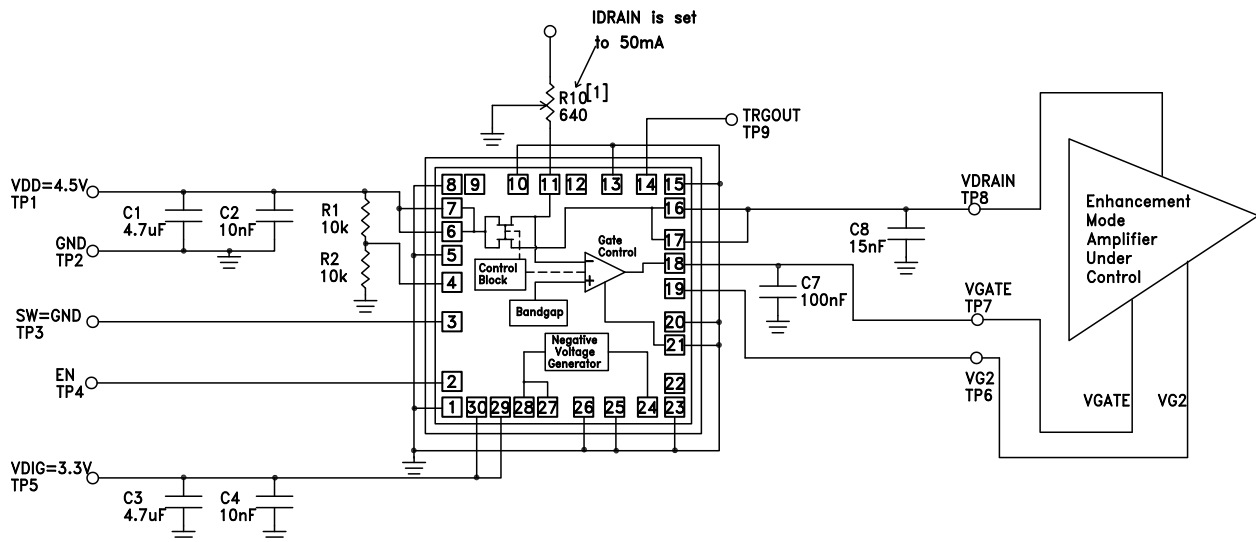

Figure 2c. Enhancement Mode Amplifier Typical Application Circuit (Mode 3)

Table 3 - List of Bias Settings for Various Hittite Amplifiers

Hittite Part Number	VDRAIN (V)	VDD (V)	IDRAIN (mA)	RSENSE (kOhm)	R2 (kOhm)	R1 (kOhm)	VG2 (V)
LNAs							
HMC-ALH140	4	4.60	60	0.53	open	open	-
HMC-ALH216	4	4.45	90	0.36	open	open	-
HMC-ALH244	4	4.45	45	0.71	open	open	-
HMC-ALH310 ^[1]	2.5	3.02 ^[1]	52	0.62	open	open	-
HMC-ALH311 ^[1]	2.5	3.04 ^[1]	54	0.59	open	open	-
HMC-ALH313 ^[1]	2.5	3.02 ^[1]	52	0.62	open	open	-
HMC-ALH382 ^[1]	2.5	3.14 ^[1]	64	0.50	open	open	-
HMC-ALH435	5	5.30	30	1.07	5.60	5	1.5
HMC-ALH444	5	5.55	55	0.58	5.09	5	1.5
HMC-ALH476	4	4.45	90	0.36	open	open	-
HMC490	5	6.00	200	0.16	open	open	-
HMC490LP5	5	6.00	200	0.16	open	open	-
HMC504LC4B	4	4.45	90	0.36	open	open	-
HMC594	6	6.50	100	0.32	open	open	-
HMC594LC3B	6	6.50	100	0.32	open	open	-
HMC609	6	6.85	170	0.19	open	open	-
HMC609LC4	6	6.85	170	0.19	open	open	-
HMC752LC4 ^[1]	3	3.70 ^[1]	70	0.46	open	open	-
HMC753LP4E	5	5.55	55	0.58	5.09	5	1.5
HMC772LC4	4	4.45	45	0.71	open	open	-
Linear & Power							
HMC-ABH209	5	5.80	80	0.40	open	open	-
HMC-ABH264	5	5.60	120	0.27	open	open	-
HMC-AUH317	4	4.80	160	0.20	open	open	-

[1] For applications below 4V supply please contact factory.

For price, delivery, and to place orders, please contact Hittite Microwave Corporation:
 2 Elizabeth Drive, Chelmsford, MA 01824 Phone: 978-250-3343 Fax: 978-250-3373
 Order On-line at www.hittite.com

ACTIVE BIAS CONTROLLER
Table 3 - List of Bias Settings for Various Hittite Amplifiers (Continued)

Hittite Part Number	VDRAIN (V)	VDD (V)	IDRAIN (mA)	RSENSE (kOhm)	R2 (kOhm)	R1 (kOhm)	VG2 (V)
HMC-AUH318	4	4.80	160	0.20	open	open	-
HMC-AUH320	4	4.65	130	0.25	open	open	-
HMC442	5	5.43	85	0.38	open	open	-
HMC442LC3B	5	5.42	84	0.38	open	open	-
HMC442LM1	5	5.43	85	0.38	open	open	-
HMC499	5	6.00	200	0.16	open	open	-
HMC499LC4	5	6.00	200	0.16	open	open	-
Wideband (Distributed)							
HMC-ALH482	4	4.45	45	0.71	open	open	-
HMC-AUH232	5	5.90	180	0.18	4.52	5	1.5
HMC-AUH249	5	6.00	200	0.16	4.38	5	1.5
HMC-AUH312	8	8.60	60	0.53	2.82	5	1.8
HMC460	8	8.60	60	0.53	open	open	-
HMC460LC5	8	8.75	75	0.43	open	open	-
HMC463	5	5.60	60	0.53	open	open	-
HMC463LH250	5	5.60	60	0.53	open	open	-
HMC463LP5	5	5.60	60	0.53	open	open	-
HMC465	8	8.80	160	0.20	2.33	5	1.5
HMC465LP5	8	8.80	160	0.20	2.33	5	1.5
HMC562	8	8.80	80	0.40	open	open	-
HMC633	5	5.90	180	0.18	open	open	-
HMC633LC4	5	5.90	180	0.18	open	open	-
HMC634	5	5.90	180	0.18	open	open	-
HMC634LC4	5	5.90	180	0.18	open	open	-
HMC-930	10	10.88	175	0.18	3.95	5	3.5
Microwave & Optical Drivers							
HMC870LC5	7	7.83	165	0.19	open	open	-
HMC871LC5	8	8.38	75	0.43	open	open	-

ACTIVE BIAS CONTROLLER

Notes:

Данный компонент на территории Российской Федерации

Вы можете приобрести в компании MosChip.

Для оперативного оформления запроса Вам необходимо перейти по данной ссылке:

<http://moschip.ru/get-element>

Вы можете разместить у нас заказ для любого Вашего проекта, будь то серийное производство или разработка единичного прибора.

В нашем ассортименте представлены ведущие мировые производители активных и пассивных электронных компонентов.

Нашей специализацией является поставка электронной компонентной базы двойного назначения, продукции таких производителей как XILINX, Intel (ex.ALTERA), Vicor, Microchip, Texas Instruments, Analog Devices, Mini-Circuits, Amphenol, Glenair.

Сотрудничество с глобальными дистрибьюторами электронных компонентов, предоставляет возможность заказывать и получать с международных складов практически любой перечень компонентов в оптимальные для Вас сроки.

На всех этапах разработки и производства наши партнеры могут получить квалифицированную поддержку опытных инженеров.

Система менеджмента качества компании отвечает требованиям в соответствии с ГОСТ Р ИСО 9001, ГОСТ РВ 0015-002 и ЭС РД 009

Офис по работе с юридическими лицами:

105318, г.Москва, ул.Щербаковская д.3, офис 1107, 1118, ДЦ «Щербаковский»

Телефон: +7 495 668-12-70 (многоканальный)

Факс: +7 495 668-12-70 (доб.304)

E-mail: info@moschip.ru

Skype отдела продаж:

moschip.ru

moschip.ru_4

moschip.ru_6

moschip.ru_9