

NSE10 Series Navigation Switch Encoders

Features/Benefits

- Reduced size 10 mm
- Hollow shaft
- Self clinching terminals
- Positive detent feeling

Typical Applications

- Audio / Video equipment
- Navigation systems
- Computer peripherals



Construction

FUNCTION: Incremental signal.
CONTACT ARRANGEMENT: Phase difference output of two signal A and B.
TERMINAL: PC pin.

Mechanical

NUMBER OF DETENT: 24
DETENT TORQUE: 5 ± 3 mN.m
ROTATIONAL ANGLE: 360° endless.
ROTATIONAL LIFE: 100,000 cycles (1 cycle: 360° CW + 360° CCW).

Number of Pulse	Number of Detent	Detent Torque	Mounting Height	Designation
12	24	5mN.m	7	NSE10DH127
12	24	5mN.m	9	NSE10DH129
12	24	5mN.m	11	NSE10DH1211

NOTE: Specifications listed above are for switches with standard options.
For information on specific and custom switches, consult Customer Service Center.

Electrical

MAXIMUM VOLTAGE: 5 VDC.
CURRENT DC: 1 mA
DIELECTRIC STRENGTH: 50 VAC.
INSULATION RESISTANCE: 50 MΩ min / 50 VDC.
BOUNCE TIME: ≤ 5 ms

Environmental

OPERATING TEMPERATURE: -5°C to +45°C.
STORAGE TEMPERATURE: -15°C to +65°C.

Process

SOLDERING PROCESS:
Manual soldering 300°C max., 3s max.
Wave soldering 260°C max., 3s max.
No cleaning.



Navigation

How To Order

Our easy build-a-switch concept allows you to mix and match options to create the switch you need. To order, select desired option from each category and place it in the appropriate box.

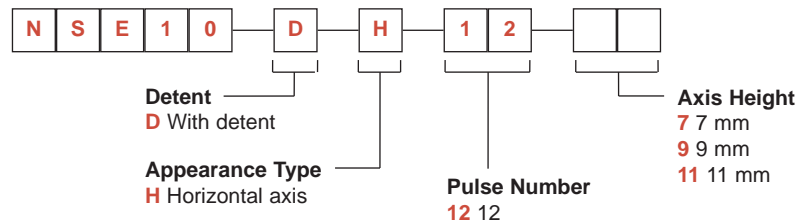

NSE10 Series Navigation Switch Encoders

NSE10



OPTION CODE	AXIS HEIGHT
7	7 mm
9	9 mm
11	11 mm

ELECTRICAL GRAPH			
Shaft rotational direction	Signal	Output	
C.W.	A (Terminal A-C)	ON	[Pulse]
		OFF	[Pulse]
	B (Terminal B-C)	ON	[Pulse]
		OFF	[Pulse]

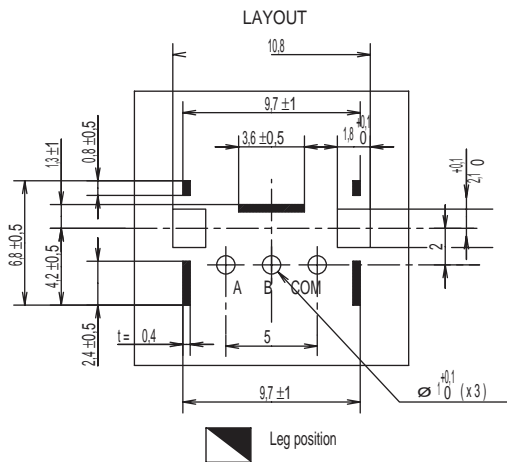

P.C.B. THICKNESS T = 1.6
View from mounting side



Navigation

NSE11 Series Navigation Switch Encoders

Features/Benefits

- Select switch
- Metallic shaft
- Self clinching terminals
- Positive detent feeling
- Large variety of shaft

Typical Applications

- Audio / Video equipment
- Navigation systems
- Computer peripherals
- Car radio



Construction

FUNCTION: Incremental signal + select switch.

CONTACT ARRANGEMENT: Phase difference output of two signal A and B.

TERMINAL: PC pin.

Mechanical

NUMBER OF DETENT: 20 or 30

DETENT TORQUE: 3 - 20 mN.m

ROTATIONAL ANGLE: 360° endless.

ROTATIONAL LIFE: 15,000 cycles (1 cycle: 360° CW + 360° CCW).

Number of Pulse	Number of Detent	Bracket Spacing	Select Function	Designation
15	30	11 mm	No	NSE11DV57NCF215A
20	20	11 mm	No	NSE11DV57NCF220A
15	30	11 mm	Yes	NSE11DSV57NAF215A
20	20	11 mm	Yes	NSE11DSV57NAF220A
15	30	13,8 mm	Yes	NSE11DSV57NAF215F
20	20	13,8 mm	Yes	NSE11DSV57NAF220F

NOTE: Specifications listed above are for switches with standard options.
For information on specific and custom switches, consult Customer Service Center.

Electrical

MAXIMUM VOLTAGE: 5 VDC.

MAXIMUM CURRENT DC: 10 mA

MINIMUM CURRENT DC: 1 mA

DIELECTRIC STRENGTH: 300 VAC / 1 mA.

INSULATION RESISTANCE: 100 MΩ min.

BOUNCE TIME: ≤ 2 ms

Switch Function

CONTACT: SPST

MAXIMUM POWER: 5 VDC 10 mA (min. 1 mA)

CONTACT RESISTANCE: Initial 100mΩ

TRAVEL: 0,5 mm +/- 0,4 mm

OPERATING FORCE: 4,5 +/- 1,5 N

LIFE TIME: 20,000 operations

Environmental

OPERATING TEMPERATURE: -30°C to +70°C.

STORAGE TEMPERATURE: -40°C to +85°C.

Process

SOLDERING PROCESS:

Manual soldering 300°C max., 3s max.

Wave soldering 260°C max., 3s max.

No cleaning.

How To Order

Our easy build-a-switch concept allows you to mix and match options to create the switch you need. To order, select desired option from each category and place it in the appropriate box.

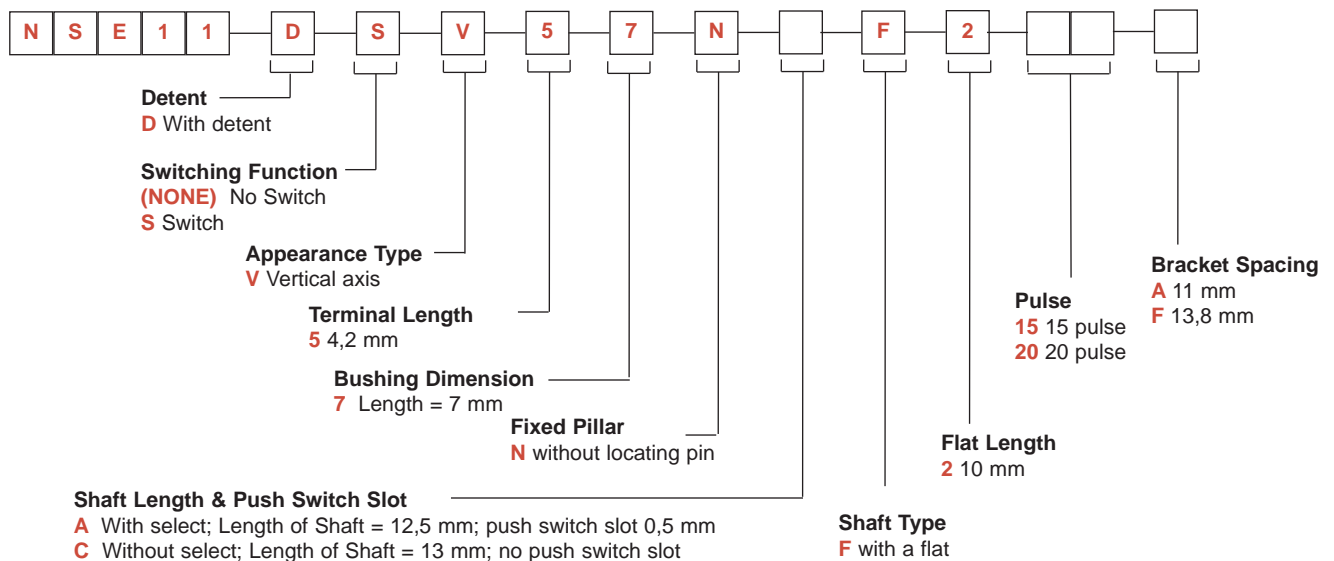

NSE11 Series Navigation Switch Encoders

NSE11



OPTION CODE	LS Length of Shaft	A Push Switch Slot
A - with select	12,5 mm	0,5
C - without select	13 mm	no push switch slot

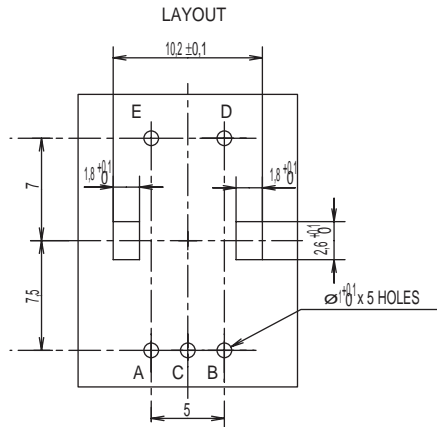
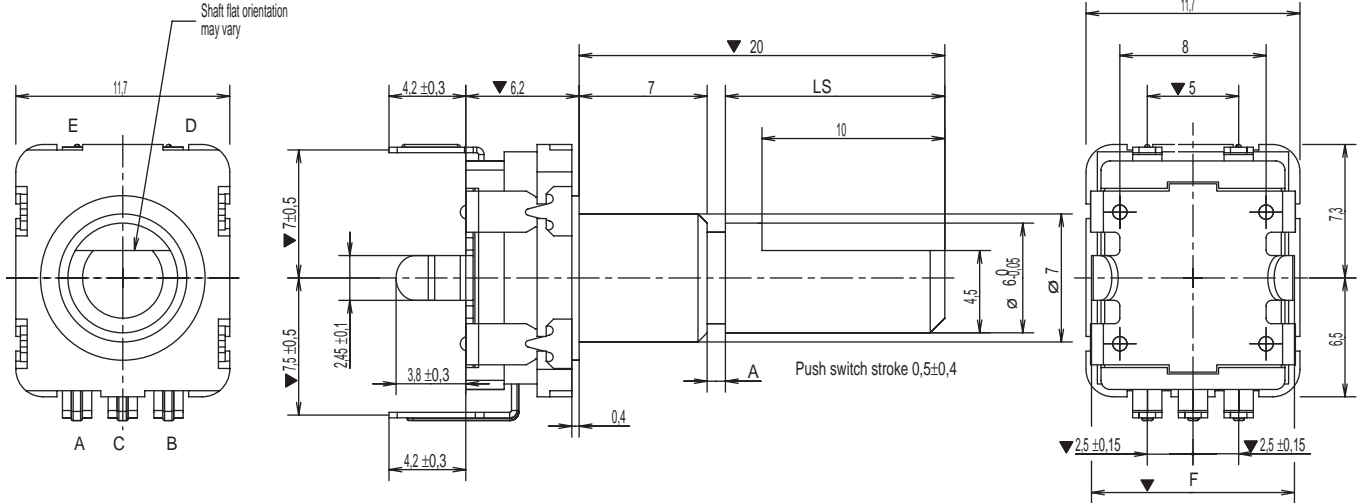

P.C.B. THICKNESS T = 1,6
View from mounting side

TERMINAL DETAIL

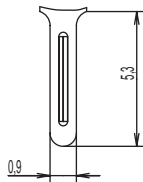

OPTION CODE	F Bracket Spacing
A	11 mm
F	13,8 mm

15 Pulse

20 Pulse

ELECTRICAL GRAPH		
Shaft rotational direction	Signal	Output
C.W.	A (Terminal A-C)	ON OFF
	B (Terminal B-C)	ON OFF

ELECTRICAL GRAPH		
Shaft rotational direction	Signal	Output
C.W.	A (Terminal A-C)	ON OFF
	B (Terminal B-C)	ON OFF

SWITCH GRAPH



SWITCH GRAPH



NSE12 Series Navigation Switch Encoders

Features/Benefits

- Select switch
- Low profile
- Self clinching terminals
- Positive detent feeling

Typical Applications

- Audio / Video equipment
- Navigation systems
- White goods equipment
- Car radio



Construction

FUNCTION: Incremental signal + select switch.

CONTACT ARRANGEMENT: Phase difference output of two signal A and B.

TERMINAL: PC pin.

Mechanical

NUMBER OF DETENT: 12 or 24

DETENT TORQUE: 3 - 20 mN.m

ROTATIONAL ANGLE: 360° endless.

ROTATIONAL LIFE: 30,000 cycles (1 cycle: 360° CW + 360° CCW).

Number of Pulse	Number of Detent	Height	Select Function	Designation
12	12	20 mm	No	NSE12DV1220
24	24	20 mm	No	NSE12DV2420
12	12	25 mm	No	NSE12DV1225
24	24	25 mm	No	NSE12DV2425
12	12	20 mm	Yes	NSE12DSV1220
24	24	20 mm	Yes	NSE12DSV2420
12	12	25 mm	Yes	NSE12DSV1225
24	24	25 mm	Yes	NSE12DSV2425

Electrical

MAXIMUM VOLTAGE: 5 VDC.

MAXIMUM CURRENT DC: 10 mA

MINIMUM CURRENT DC: 1 mA

DIELECTRIC STRENGTH: 50 VAC / 1 mA.

INSULATION RESISTANCE: 10 MΩ.

BOUNCE TIME: ≤ 2 ms

Switch Function

CONTACT: SPST

MAXIMUM POWER: 5 VDC - 10 mA (min. 1 mA).

CONTACT RESISTANCE INITIAL: 100 mΩ.

TRAVEL: 0,5 mm +0,2/-0,1 mm

OPERATING FORCE: 4,5 ± 1,5 N.

LIFE TIME: 20,000 operations.

Environmental

OPERATING TEMPERATURE: -10°C to +70°C.

STORAGE TEMPERATURE: -40°C to +85°C.

Process

SOLDERING PROCESS:

Manual soldering 300°C max., 3s max.

Wave soldering 260°C max., 3s max.

No cleaning.

NOTE: Specifications listed above are for switches with standard options.
For information on specific and custom switches, consult Customer Service Center.

How To Order

Our easy build-a-switch concept allows you to mix and match options to create the switch you need. To order, select desired option from each category and place it in the appropriate box.



NSE12 Series Navigation Switch Encoders

NSE12



OPTION CODE	L TOTAL HEIGHT	H
20	20 mm	7
25	25 mm	12

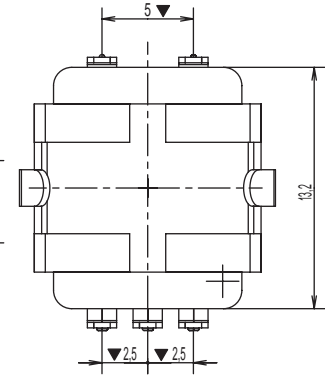

P.C.B. THICKNESS T = 1.6
View from mounting side

ELECTRICAL GRAPH		
Shaft rotational direction	Signal	Output
C.W.	A (Terminal A-C)	ON OFF
	B (Terminal B-C)	ON OFF

SWITCH GRAPH



Navigation

NSE16 Series Navigation Switch Encoders

Features/Benefits

- Select switch
- Long life
- Self clinching terminals
- Positive detent feeling

Typical Applications

- Audio / Video equipment
- White goods equipment



Construction

FUNCTION: Incremental signal.
CONTACT ARRANGEMENT: Phase difference output of two signal A and B.
TERMINAL: PC pin.

Mechanical

NUMBER OF DETENT: 24
DETENT TORQUE: 1 - 10 mN.m
ROTATIONAL ANGLE: 360° endless.
ROTATIONAL LIFE: 50,000 cycles (1 cycle: 360° CW + 360° CCW).

Number of Pulse	Number of Detent	Height	Select Function	Designation
24	24	26,5 mm	No	NSE16DV2426
24	24	31,5 mm	No	NSE16DV2431

Electrical

MAXIMUM VOLTAGE: 5 VDC.
MAXIMUM CURRENT DC: 0,5 mA
DIELECTRIC STRENGTH: 50 VAC.
INSULATION RESISTANCE: 10 MΩ.
BOUNCE TIME: ≤ 2 ms

Environmental

OPERATING TEMPERATURE: -25°C to +80°C.
STORAGE TEMPERATURE: -40°C to +85°C.

Process

SOLDERING PROCESS:
Manual soldering 300°C max., 3s max.
Wave soldering 260°C max., 3s max.
No cleaning.

NOTE: Specifications listed above are for switches with standard options.
For information on specific and custom switches, consult Customer Service Center.

How To Order

Our easy build-a-switch concept allows you to mix and match options to create the switch you need. To order, select desired option from each category and place it in the appropriate box.



NSE16 Series Navigation Switch Encoders

NSE16



OPTION CODE	L TOTAL HEIGHT
26	26,5 mm
31	31,5 mm

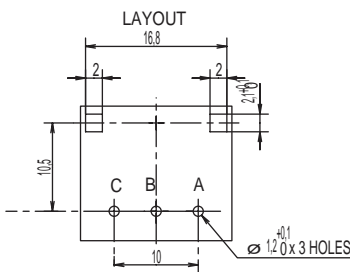
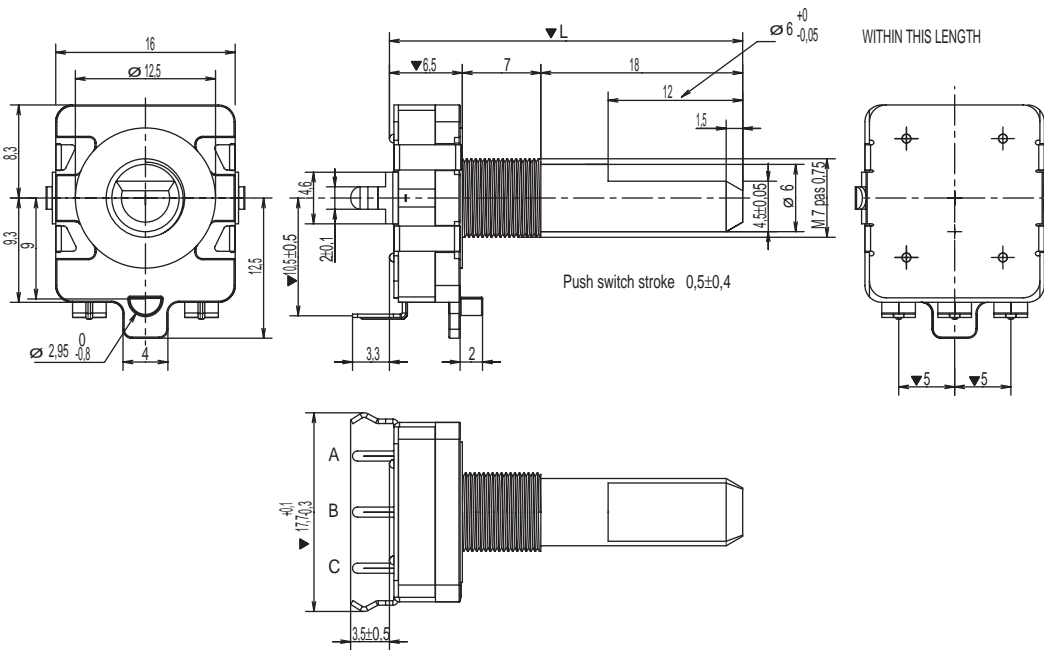

P.C.B. THICKNESS T = 1,6
View from mounting side

ELECTRICAL GRAPH		
Shaft rotational direction	Signal	Output
C.W.	A (Terminal A-C)	ON OFF
	B (Terminal B-C)	ON OFF

SWITCH GRAPH



Navigation

Данный компонент на территории Российской Федерации

Вы можете приобрести в компании MosChip.

Для оперативного оформления запроса Вам необходимо перейти по данной ссылке:

<http://moschip.ru/get-element>

Вы можете разместить у нас заказ для любого Вашего проекта, будь то серийное производство или разработка единичного прибора.

В нашем ассортименте представлены ведущие мировые производители активных и пассивных электронных компонентов.

Нашей специализацией является поставка электронной компонентной базы двойного назначения, продукции таких производителей как XILINX, Intel (ex.ALTERA), Vicor, Microchip, Texas Instruments, Analog Devices, Mini-Circuits, Amphenol, Glenair.

Сотрудничество с глобальными дистрибьюторами электронных компонентов, предоставляет возможность заказывать и получать с международных складов практически любой перечень компонентов в оптимальные для Вас сроки.

На всех этапах разработки и производства наши партнеры могут получить квалифицированную поддержку опытных инженеров.

Система менеджмента качества компании отвечает требованиям в соответствии с ГОСТ Р ИСО 9001, ГОСТ РВ 0015-002 и ЭС РД 009

Офис по работе с юридическими лицами:

105318, г.Москва, ул.Щербаковская д.3, офис 1107, 1118, ДЦ «Щербаковский»

Телефон: +7 495 668-12-70 (многоканальный)

Факс: +7 495 668-12-70 (доб.304)

E-mail: info@moschip.ru

Skype отдела продаж:

moschip.ru

moschip.ru_4

moschip.ru_6

moschip.ru_9