

DC-DC Converter Short Form

MPDRX303S,MPDRX304S (Ultra High Speed Response POL)

■ Features

- Ultra High Sped Response
- Wide Input range (6.2V to 13.2V)
- Wide output range (0.8V to 1.65V / 1.6V to 3.63V)
- 26A Output Current
- Wide operational temperature (-40°C to +85°C)
- ON/OFF / Output voltage sense / Over current function / 2 P-good function / Variable Start-up Speed function (by external capacitor)

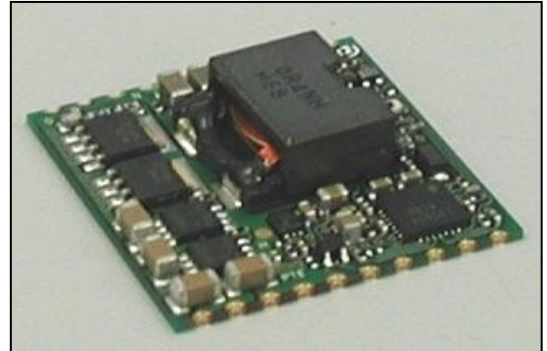

■ GENERAL SPECIFICATIONS (Ta=25°C)

Item	Symbol	Condition	MIN.	TYP.	MAX.	UNIT
Input Voltage	Vin		6.2	9.6	13.2	V
Output Voltage Adjustable Range	Vout	MPDRX304S	0.8	-	1.65	V
		MPDRX303S	1.6	-	3.63	
Output Current	Iout		0	-	26	A
Ripple Voltage	Vrpl	Vin=9.6V, Vout=1.2V, Iout=26A	-	15	-	mVpp
		Vin=9.6V, Vout=3.3V, Iout=26A	-	20	-	
Efficiency	EFF	Vin=9.6V, Vout=1.2V, Iout=26A	-	84	-	%
		Vin=9.6V, Vout=3.3V, Iout=26A	-	90	-	

■ DIMENSIONS

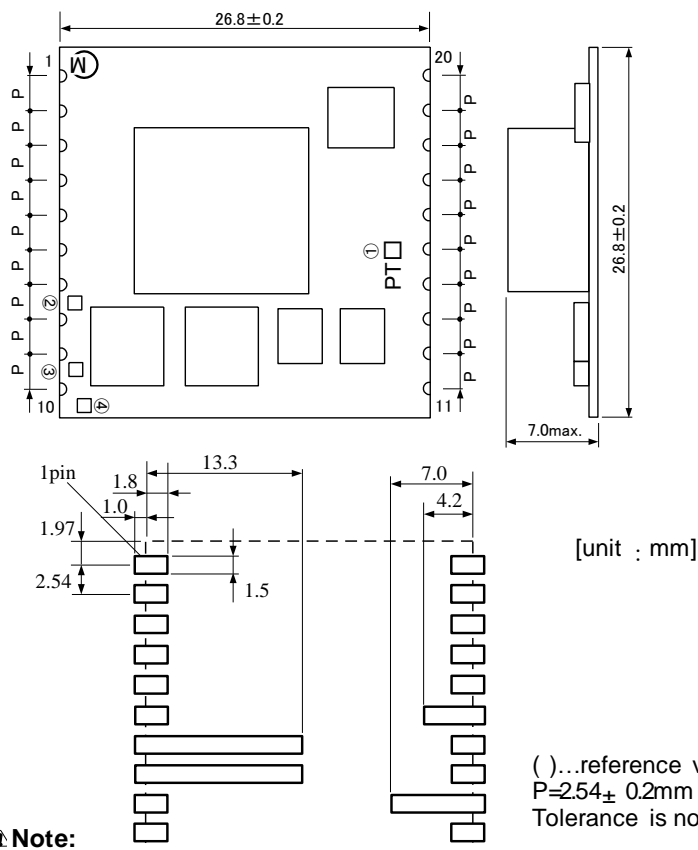

Pin No.	Symbol	Function
1	SENSE	Output voltage sense
2,3,4	Vout	Output
5,6,7, 8,13, 14,15	GND	GND
9	FT	Output trim
10	VAR	Output voltage adjustment
11,12	Vin	Input
17	SS	Soft start
18	N.C.	This pin must be left open.
19	POW-GOOD1	Power Good
20	POW-GOOD2	Power Good
16	ON/OFF	Remote ON/OFF

⚠ Note:

1. This datasheet is downloaded from the website of Murata Manufacturing co., Ltd. Therefore, it's specifications are subject to change or our products in it may be discontinued without advance notice. Please check with our sales representatives or product engineers before ordering.
2. This datasheet has only typical specifications because there is no space for detailed specifications. Therefore, please approve our product specifications or transact the approval sheet for product specifications before ordering.

■ OUTPUT VOLTAGE ADJUSTMENT

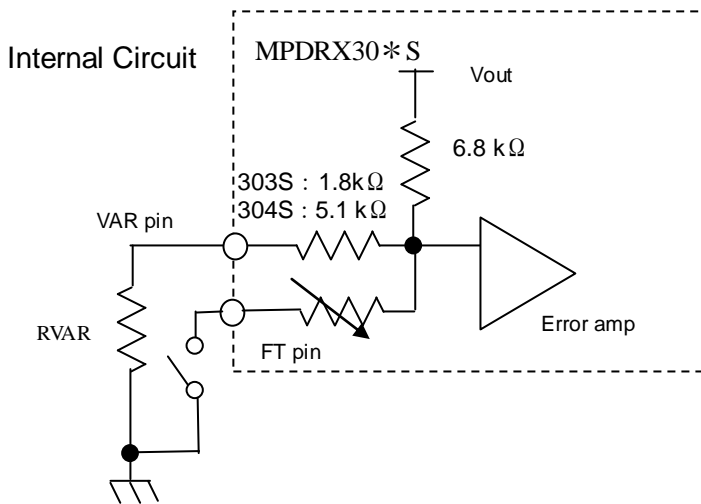

①MPDRX303S (FT-pin : SHORT to GND)

$$RVAR = \frac{5440}{Voadj[V] \times 1.002 - 1.5[V]} - 1800 \quad [\Omega]$$

②MPDRX304S

(a) $0.8 \leq Vout < 0.95V$ (FT-pin : OPEN)

$$RVAR = \frac{5440}{Voadj[V] \times 1.002 - 0.8[V]} - 5100 \quad [\Omega]$$

(b) $0.95 \leq Vout \leq 1.65V$ (FT-pin : SHORT to GND)

$$RVAR = \frac{5440}{Voadj[V] \times 1.002 - 0.95[V]} - 5100 \quad [\Omega]$$

<RVAR CALCULATION EXAMPLE>

①MPDRX303S

Voadj [V]	RVAR計算結果[Ω] Calculated RVAR[Ω]	FT pin (9pin)
3.63	745	Short to GND
3.3	1211	Short to GND
2.5	3613	Short to GND
1.8	16118	Short to GND
1.6	50913	Short to GND

②MPDRX304S

Voadj [V]	RVAR計算結果[Ω] Calculated RVAR[Ω]	FT pin (9pin)
1.65	2635	Short to GND
1.5	4737	Short to GND
1.2	16453	Short to GND
1.0	99515	Short to GND
0.95	2858058	Short to GND
0.9	48338	Open
0.8	3394900	Open

■ TEST CIRCUIT

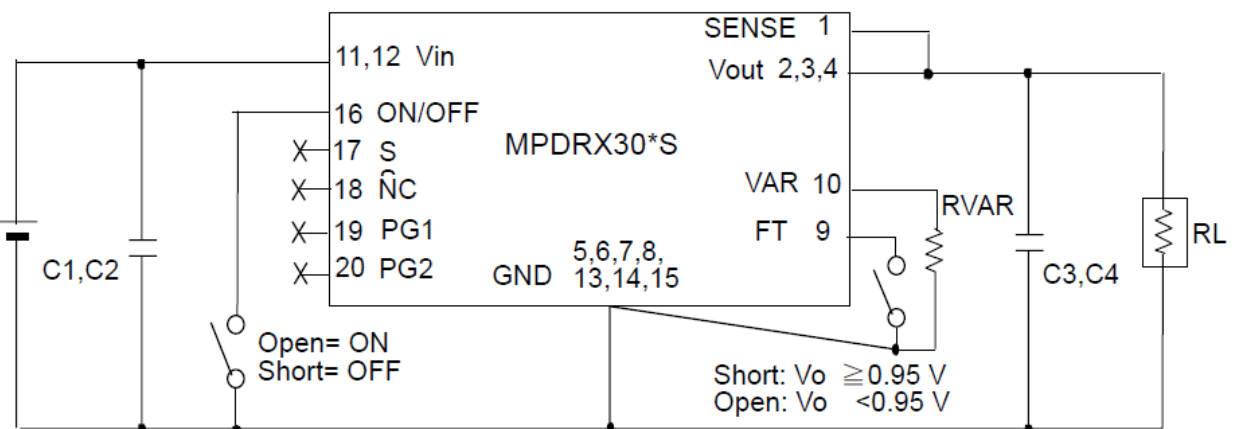

C1,C2 : 22μF/25V×2 (Ceramic Capacitor)
C3,C4 : 100μF/6.3V×2 (Ceramic Capacitor)

⚠ **Note:** Please make sure to place C1,C2,C3 and C4 nearby input and output terminal of DC-DC converter.

- This datasheet is downloaded from the website of Murata Manufacturing co., ltd. Therefore, it's specifications are subject to change or our products in it may be discontinued without advance notice. Please check with our sales representatives or product engineers before ordering.
- This datasheet has only typical specifications because there is no space for detailed specifications. Therefore, please approve our product specifications or transact the approval sheet for product specifications before ordering.

■ THERMAL DERATING

MPDRX303S
($V_{in}=6.2\sim 12V$ 、 $V_{out}=1.6\sim 3.63V$ 、
Airflow: 0,1.5m/s)

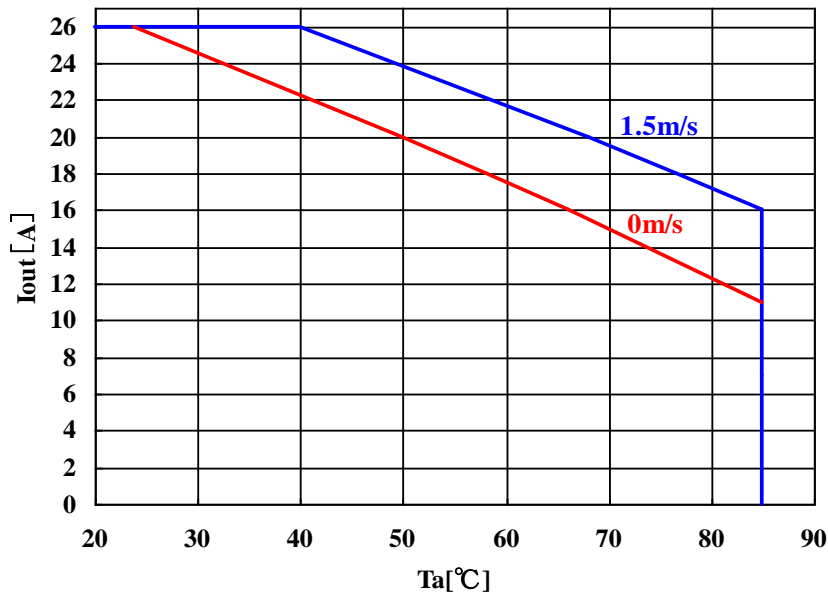

MPDRX304S
($V_{in}=6.2\sim 12V$ 、 $V_{out}=0.8\sim 1.65V$ 、
Airflow: 0,1.5m/s)

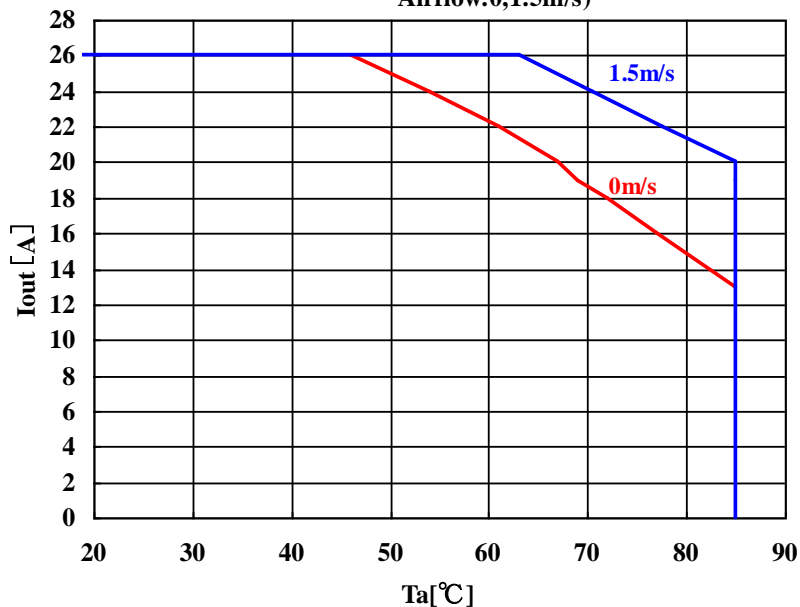

⚠ Note:

1. This datasheet is downloaded from the website of Murata Manufacturing co., Ltd. Therefore, it's specifications are subject to change or our products in it may be discontinued without advance notice. Please check with our sales representatives or product engineers before ordering.
2. This datasheet has only typical specifications because there is no space for detailed specifications. Therefore, please approve our product specifications or transact the approval sheet for product specifications before ordering.

EFFICIENCY & REGULATION CHARACTERISTICS

MPDRX303S

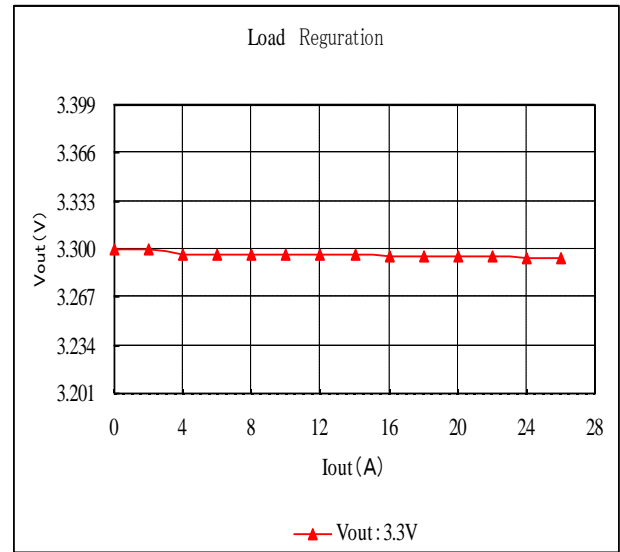
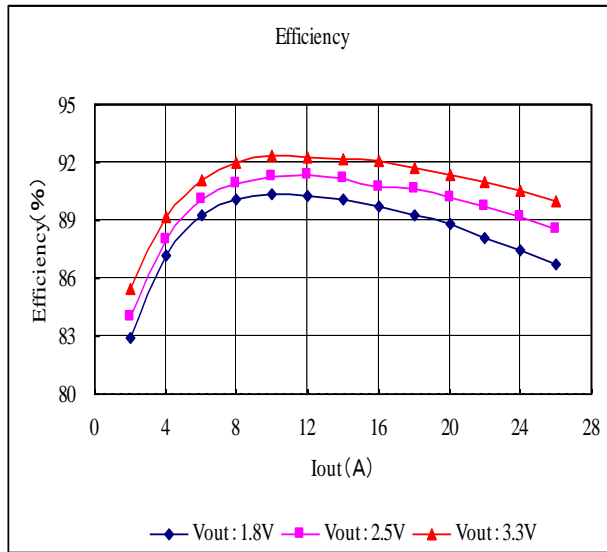

MPDRX304S

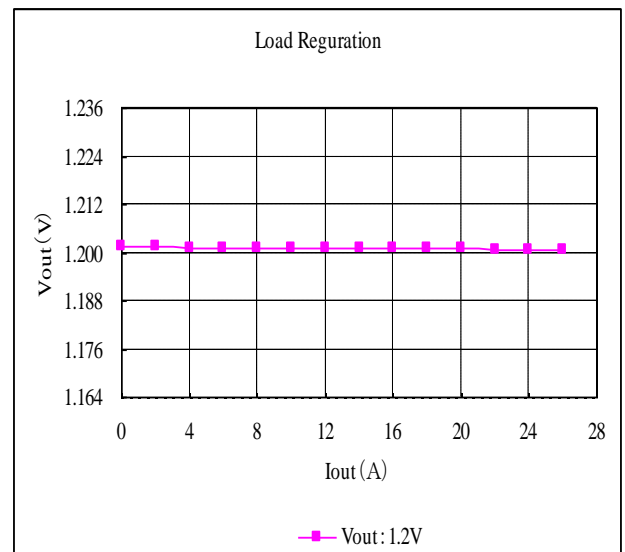
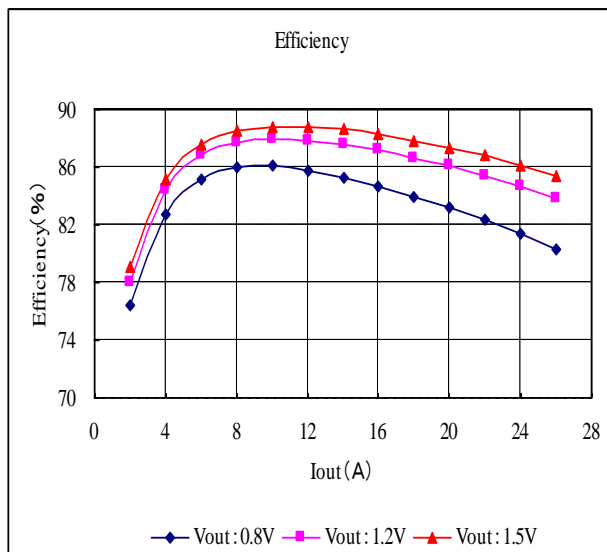

Note:

1. This datasheet is downloaded from the website of Murata Manufacturing co., Ltd. Therefore, it's specifications are subject to change or our products in it may be discontinued without advance notice. Please check with our sales representatives or product engineers before ordering.
2. This datasheet has only typical specifications because there is no space for detailed specifications. Therefore, please approve our product specifications or transact the approval sheet for product specifications before ordering.

Данный компонент на территории Российской Федерации

Вы можете приобрести в компании MosChip.

Для оперативного оформления запроса Вам необходимо перейти по данной ссылке:

<http://moschip.ru/get-element>

Вы можете разместить у нас заказ для любого Вашего проекта, будь то серийное производство или разработка единичного прибора.

В нашем ассортименте представлены ведущие мировые производители активных и пассивных электронных компонентов.

Нашей специализацией является поставка электронной компонентной базы двойного назначения, продукции таких производителей как XILINX, Intel (ex.ALTERA), Vicor, Microchip, Texas Instruments, Analog Devices, Mini-Circuits, Amphenol, Glenair.

Сотрудничество с глобальными дистрибьюторами электронных компонентов, предоставляет возможность заказывать и получать с международных складов практически любой перечень компонентов в оптимальные для Вас сроки.

На всех этапах разработки и производства наши партнеры могут получить квалифицированную поддержку опытных инженеров.

Система менеджмента качества компании отвечает требованиям в соответствии с ГОСТ Р ИСО 9001, ГОСТ РВ 0015-002 и ЭС РД 009

Офис по работе с юридическими лицами:

105318, г.Москва, ул.Щербаковская д.3, офис 1107, 1118, ДЦ «Щербаковский»

Телефон: +7 495 668-12-70 (многоканальный)

Факс: +7 495 668-12-70 (доб.304)

E-mail: info@moschip.ru

Skype отдела продаж:

moschip.ru

moschip.ru_4

moschip.ru_6

moschip.ru_9