

THIS DRAWING IS UNPUBLISHED. RELEASED FOR PUBLICATION 2011  
 © COPYRIGHT 2011 ALL RIGHTS RESERVED.

LOC		DIST		REVISIONS			
P	LTR	DESCRIPTION	DATE	DWN	APVD		
4		REVISED	02MAY2013	KR	JC		
5		UPDATED	22JUL2013	MZ	JC		
A		PARTS RELEASED FOR PRODUCTION	13NOV2013	MZ	JC		
B		ECR-15-011011	27JUL2015	RS	PO		



- NOTES:
- 1 MATERIAL: PA GF (NATURAL AND BLACK COLOUR)
  - 2 ALL POLARIZATION KEYS SHOWN FOR REF ONLY
  - 3 WAYS I.D.
  - 4 CURRENT RATING
  - 5 VOLTAGE RATING
  - 6 RIB CLOSING CAVITIES BY CHANGE OVER
  - 7 TE LOGO
  - 8 TE PART NUMBER
  - 9 DATA CODE AND CAVITY I.D.
  - 10 AREA FOR AGENCIES APPROVAL LOGO
- 11) SEE C-DRAWING 293682 (LOCKING CAP) TO GET IP 40
- 12 IP CODE
  - 13 POLARISATION KEY "TYPE D" SUITABLE FOR DALI APPLICATION
  - 14 SLOTS TO ALLOW DELATCHING TOOL OPERATION. FOR DELATCHING TOOL AND OPERATION REFER TO APPLICATION SPECIFICATION



THIS DRAWING IS A CONTROLLED DOCUMENT.		DWN M. ZUCCA 01APR2011	 TE Connectivity	
DIMENSIONS: mm		CHK M. ZUCCA 01APR2011		
TOLERANCES UNLESS OTHERWISE SPECIFIED:		APVD G. TURCO 01APR2011	NAME SOCKET HOUSING PANEL MOUNT NECTOR* M-LINE 5 POLES UNSEALED VERSION	
0 PLC ± 1 PLC ±0.3 2 PLC ±0.20 3 PLC ± 4 PLC ± ANGLES ±3° FINISH		PRODUCT SPEC -	SIZE A20779	CAGE CODE C-293687
MATERIAL -		APPLICATION SPEC -	DRAWING NO -	RESTRICTED TO -
		WEIGHT -	SCALE 3:1 SHEET 1 OF 3 REV B	
		Customer Drawing		

THIS DRAWING IS UNPUBLISHED. RELEASED FOR PUBLICATION 2011  
 © COPYRIGHT 2011 ALL RIGHTS RESERVED.

LOC	DIST	REVISIONS			
P	LTR	DESCRIPTION	DATE	DWN	APVD
-	-	SEE SHEET 1	-	-	-

### POLARIZATION TYPES

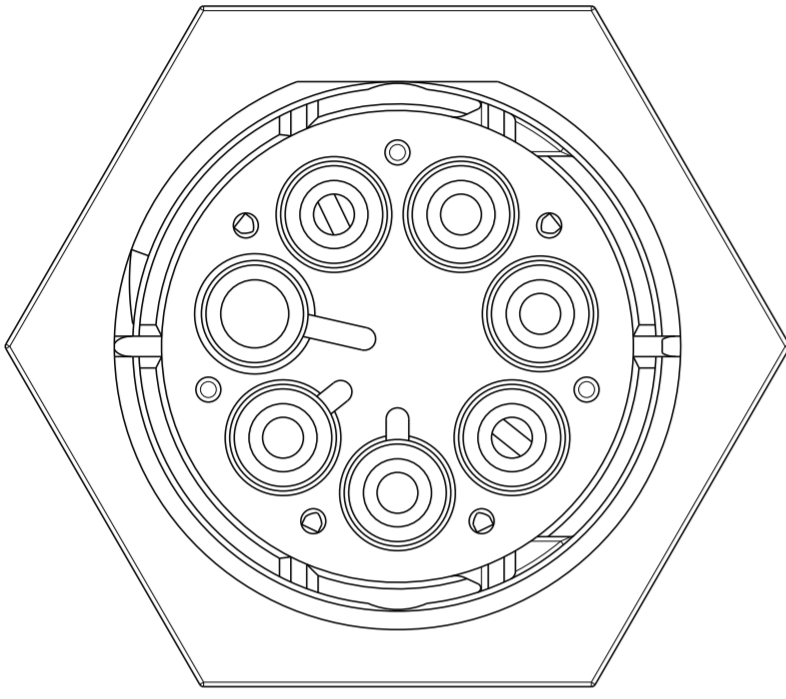
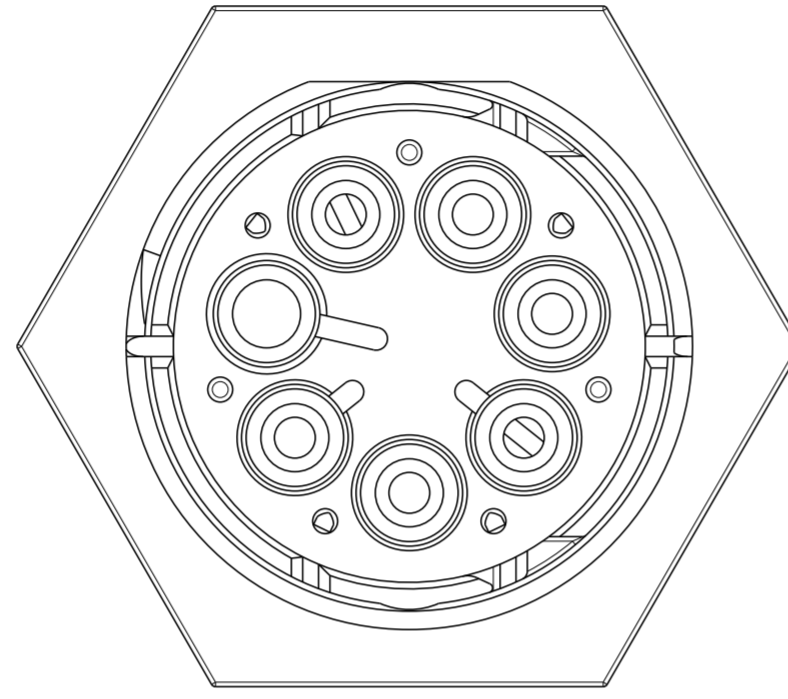
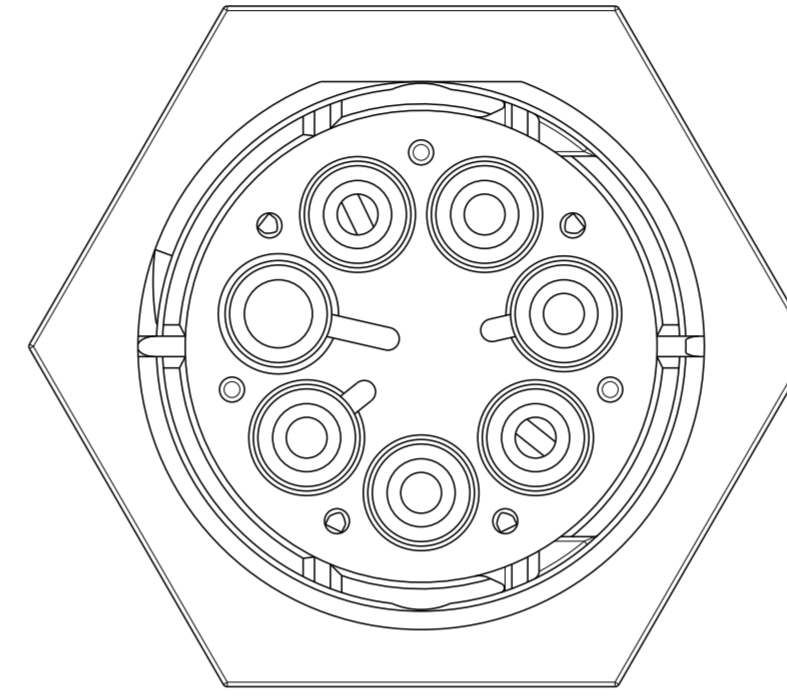
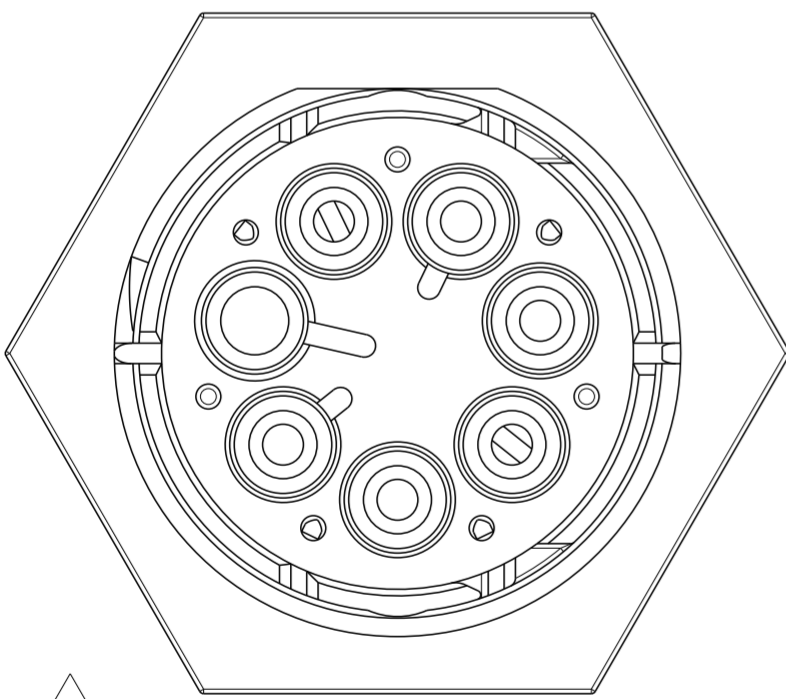
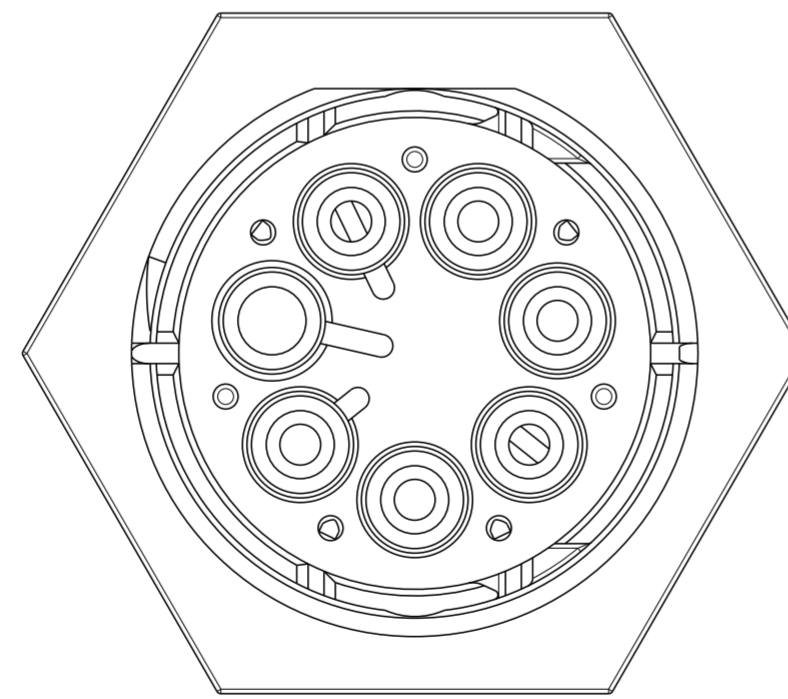
POLARIZATION TYPE "A"	POLARIZATION TYPE "B"	POLARIZATION TYPE "C"
		
PNs 0-293673-1 AND 1-293673-1	PNs 0-293673-2 AND 1-293673-2	PNs 0-293673-3 AND 1-293673-3
POLARIZATION TYPE "D"	POLARIZATION TYPE "E"	
		
PNs 0-293673-4 AND 1-293673-4	PNs 0-293673-5 AND 1-293673-5	

NOTE	POL. KEYING	COLOUR	DESCRIPTION	REV.	P/N
1	E	BLACK	SOCKET HSG 5 POLES PANEL MOUNT NECTOR* M-LINE	A	1-293687-5
1, 13	D	BLACK	SOCKET HSG 5 POLES PANEL MOUNT NECTOR* M-LINE	A	1-293687-4
1	C	BLACK	SOCKET HSG 5 POLES PANEL MOUNT NECTOR* M-LINE	A	1-293687-3
1	B	BLACK	SOCKET HSG 5 POLES PANEL MOUNT NECTOR* M-LINE	A	1-293687-2
1	A	BLACK	SOCKET HSG 5 POLES PANEL MOUNT NECTOR* M-LINE	A	1-293687-1
1	E	NATURAL	SOCKET HSG 5 POLES PANEL MOUNT NECTOR* M-LINE	A	0-293687-5
1, 13	D	NATURAL	SOCKET HSG 5 POLES PANEL MOUNT NECTOR* M-LINE	A	0-293687-4
1	C	NATURAL	SOCKET HSG 5 POLES PANEL MOUNT NECTOR* M-LINE	A	0-293687-3
1	B	NATURAL	SOCKET HSG 5 POLES PANEL MOUNT NECTOR* M-LINE	A	0-293687-2
1	A	NATURAL	SOCKET HSG 5 POLES PANEL MOUNT NECTOR* M-LINE	A	0-293687-1

THIS DRAWING IS A CONTROLLED DOCUMENT.

DWN	M. ZUCCA	01APR2011
CHK	M. ZUCCA	01APR2011
APVD	G. TURCO	01APR2011

**STE** TE Connectivity

NAME: SOCKET HOUSING PANEL MOUNT NECTOR\* M-LINE 5 POLES UNSEALED VERSION

SIZE	CAGE CODE	DRAWING NO	RESTRICTED TO
A2	0779	C-293687	-

Customer Drawing SCALE 3:1 SHEET 2 OF 3 REV B

DIMENSIONS:	TOLERANCES UNLESS OTHERWISE SPECIFIED:
mm	0 PLC ±-
	1 PLC ±0.3
	2 PLC ±0.20
	3 PLC ±-
	4 PLC ±-
	ANGLES ±3°
MATERIAL	FINISH
-	-

THIS DRAWING IS UNPUBLISHED. RELEASED FOR PUBLICATION 2011  
 © COPYRIGHT 2011 ALL RIGHTS RESERVED.

LOC		DIST		REVISIONS			
P	LTR	DESCRIPTION	DATE	DWN	APVD		
-	-	SEE SHEET 1	-	-	-		

### PN 293687-3 AS SHOWN

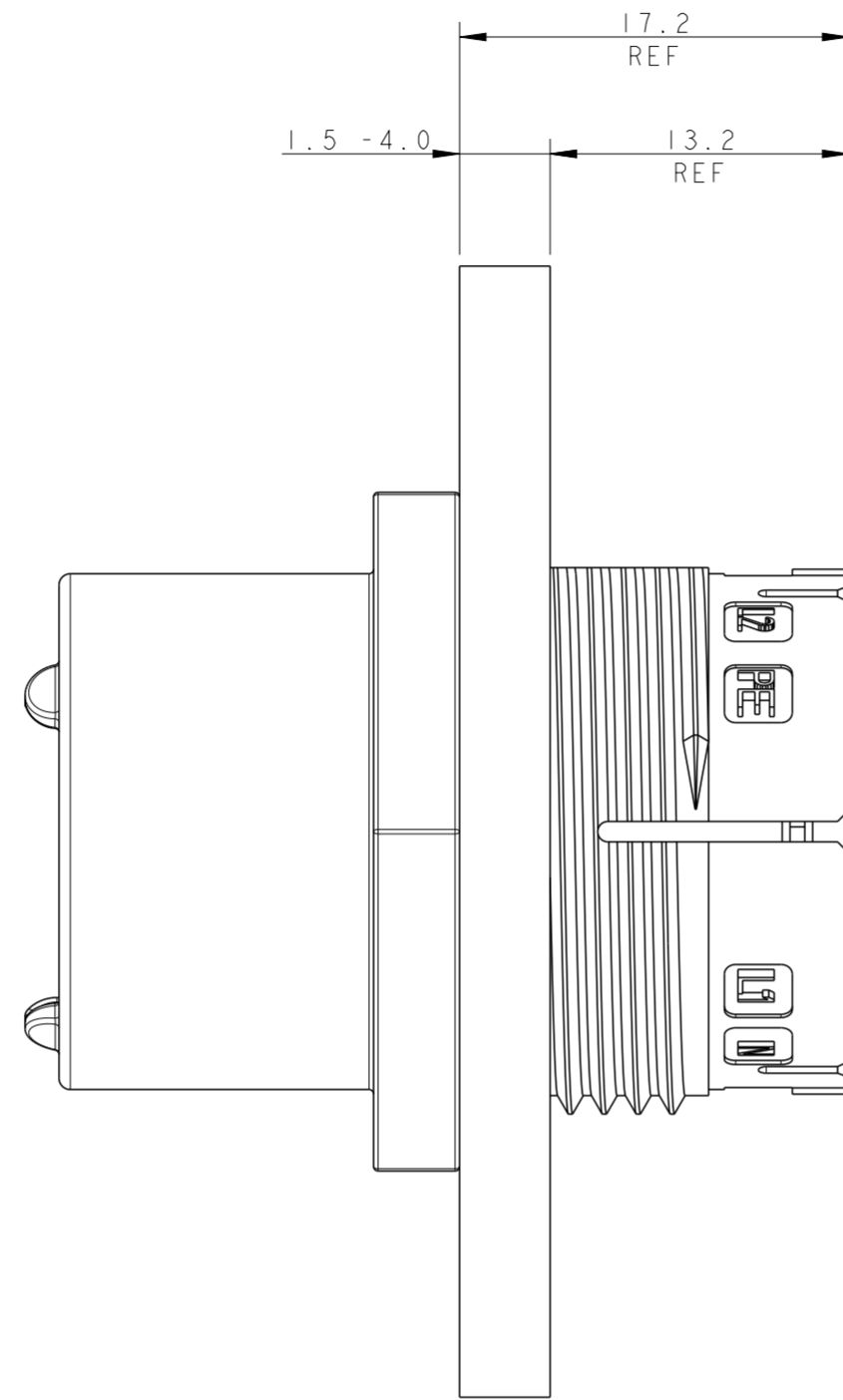

### PANEL/WALL SUGGESTED LAYOUT



3D VIEWS,  
FOR REFERENCE ONLY  
PN 293687-3 AS SHOWN



SCALE 1:1

THIS DRAWING IS A CONTROLLED DOCUMENT.		DWN M. ZUCCA 01APR2011	 TE Connectivity	
DIMENSIONS: mm		CHK M. ZUCCA 01APR2011		
TOLERANCES UNLESS OTHERWISE SPECIFIED:		APVD G. TURCO 01APR2011	NAME SOCKET HOUSING PANEL MOUNT NECTOR* M-LINE 5 POLES UNSEALED VERSION	
0 PLC ± 1 PLC ±0.3 2 PLC ±0.20 3 PLC ± 4 PLC ± ANGLES ±3° FINISH		PRODUCT SPEC -	SIZE A200779	CAGE CODE C-293687
MATERIAL -		APPLICATION SPEC -	WEIGHT -	RESTRICTED TO -
-		Customer Drawing	SCALE 3:1	SHEET 3 OF 3 REV B

## Данный компонент на территории Российской Федерации

### Вы можете приобрести в компании MosChip.

Для оперативного оформления запроса Вам необходимо перейти по данной ссылке:

<http://moschip.ru/get-element>

Вы можете разместить у нас заказ для любого Вашего проекта, будь то серийное производство или разработка единичного прибора.

В нашем ассортименте представлены ведущие мировые производители активных и пассивных электронных компонентов.

Нашей специализацией является поставка электронной компонентной базы двойного назначения, продукции таких производителей как XILINX, Intel (ex.ALTERA), Vicor, Microchip, Texas Instruments, Analog Devices, Mini-Circuits, Amphenol, Glenair.

Сотрудничество с глобальными дистрибьюторами электронных компонентов, предоставляет возможность заказывать и получать с международных складов практически любой перечень компонентов в оптимальные для Вас сроки.

На всех этапах разработки и производства наши партнеры могут получить квалифицированную поддержку опытных инженеров.

Система менеджмента качества компании отвечает требованиям в соответствии с ГОСТ Р ИСО 9001, ГОСТ РВ 0015-002 и ЭС РД 009

### Офис по работе с юридическими лицами:

105318, г.Москва, ул.Щербаковская д.3, офис 1107, 1118, ДЦ «Щербаковский»

Телефон: +7 495 668-12-70 (многоканальный)

Факс: +7 495 668-12-70 (доб.304)

E-mail: [info@moschip.ru](mailto:info@moschip.ru)

Skype отдела продаж:

moschip.ru

moschip.ru\_4

moschip.ru\_6

moschip.ru\_9