



## **Ultra Wearable Development Platform User Guide**

---

EB100 Version 1.0, June 2015

## Introduction

The Ultra Wearable Development Platform is an easy-to-use platform that demonstrates some of the ways that the Lattice iCE40 Ultra and MachXO2 FPGAs can be utilized in wearable or mobile applications. Along with the evaluation board and accessories, there are several projects available to demonstrate the functionality of the boards and components.

The Ultra Wearable Development Platform consists of two boards: the Main Board and the Sensor Board. The Main Board contains the Lattice iCE40 Ultra and MachXO2 FPGAs, which drive various components on the board. The Lattice iCE40 Ultra focuses on driving peripheral components such as LEDs, sensors and BLE connectivity. The Lattice MachXO2 focuses on driving the MIPI DSI Display from a Quad SPI flash used for frame buffer and storage. The Sensor Board contains several sensors that are typically found in mobile and wearable devices. The Sensor Board can be removed, providing access to the power and peripheral connections.

The contents of this user guide include a description of the board features, header connection descriptions and pinouts, instructions on loading demonstration bitstreams, a complete set of schematics, and the bill of materials.

## Features

The Ultra Wearable Development Platform includes:

- Ultra Wearable Development Platform Main Board:
  - iCE40 Ultra (iCE5LP-4K-SWG36) device in a 36-ball WLCSP package
  - MachXO2 (LCMXO2-2000ZE-1UWG49) device in a 49-ball WLCSP package
  - High-current IR, White, and RGB LEDs
  - Stereo Microphones
  - Connector and driver circuitry for MIPI DSI Display
  - Headers for I2C, SPI, and UART
  - Mini-USB programming connection
  - Battery charger
  - RoHS-compliant packaging and process
- Ultra Wearable Development Platform Sensor Board:
  - Bluetooth Low-Energy Module
  - Heart-rate/SpO2 Sensor and Analog Front End
  - Skin temperature sensor
  - Pressure sensor
  - Accelerometer/Gyroscope
  - Pads for soldering on battery (charger accepts Li-Ion and Li-Po)
- Syma 652030 Battery – 3.7 V, 250 mAh Lithium-Polymer Battery provides power while the USB cable is disconnected
- LG LH154Q01 Display – 240x240 Single Lane MIPI DSI Display. Must be attached prior to power-up
- USB Connector Cable – A mini-USB port provides power and a programming interface for the board
- Watch Strap – A watch strap comes pre-attached to the Sensor Board

*Note: Static electricity can severely shorten the lifespan of electrical components. Use care while handling the Ultra Wearable Development Platform to avoid ESD damage.*

Figure 1 through Figure 4 show the top and bottom sides of the Main and Sensor boards, with key features highlighted.

**Figure 1. Main Board (Top Side)**

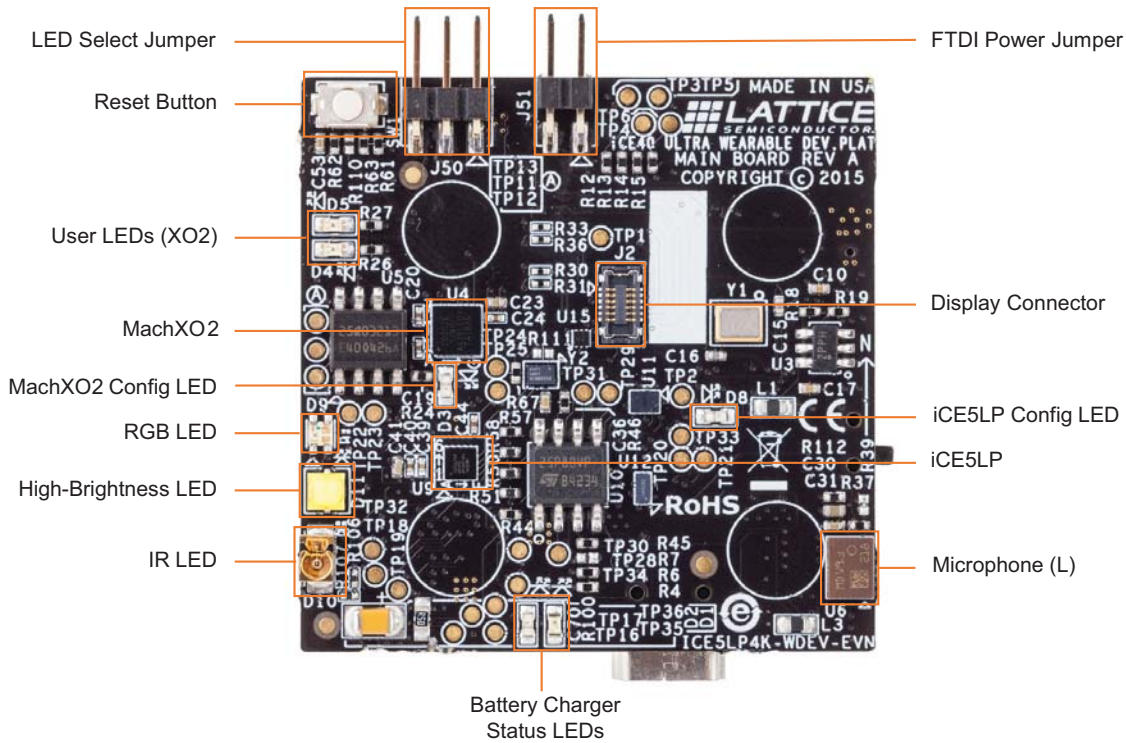

**Figure 2. Main Board (Bottom Side)**

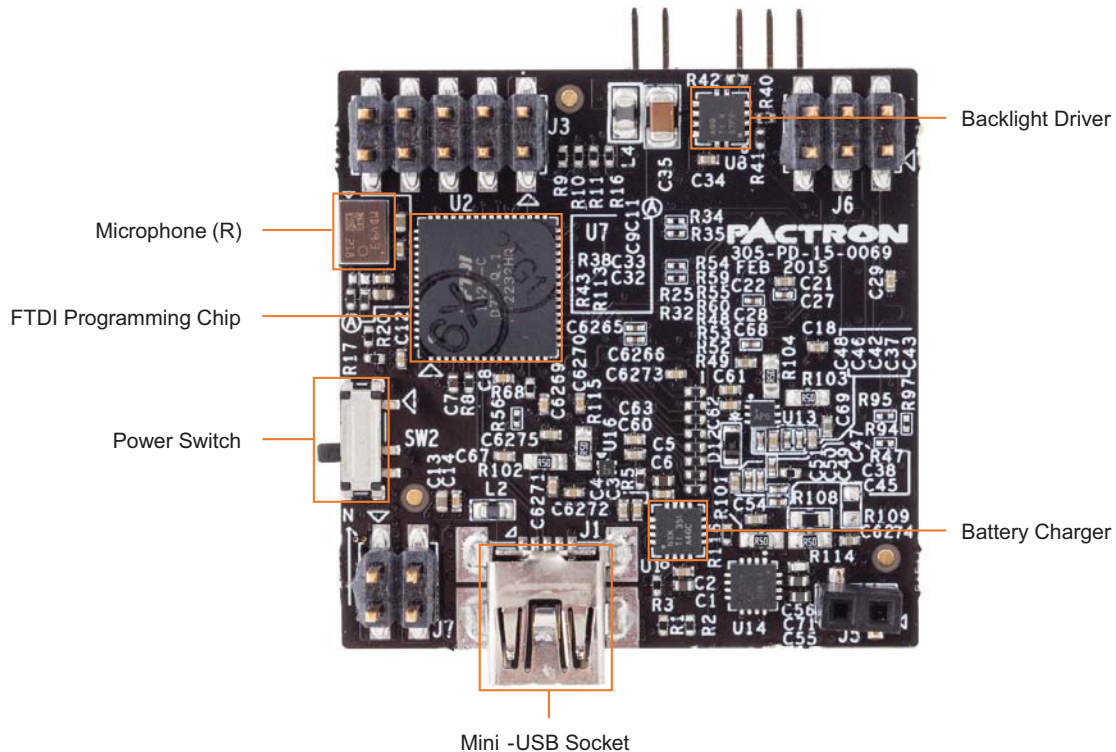

Figure 3. Sensor Board (Top Side)

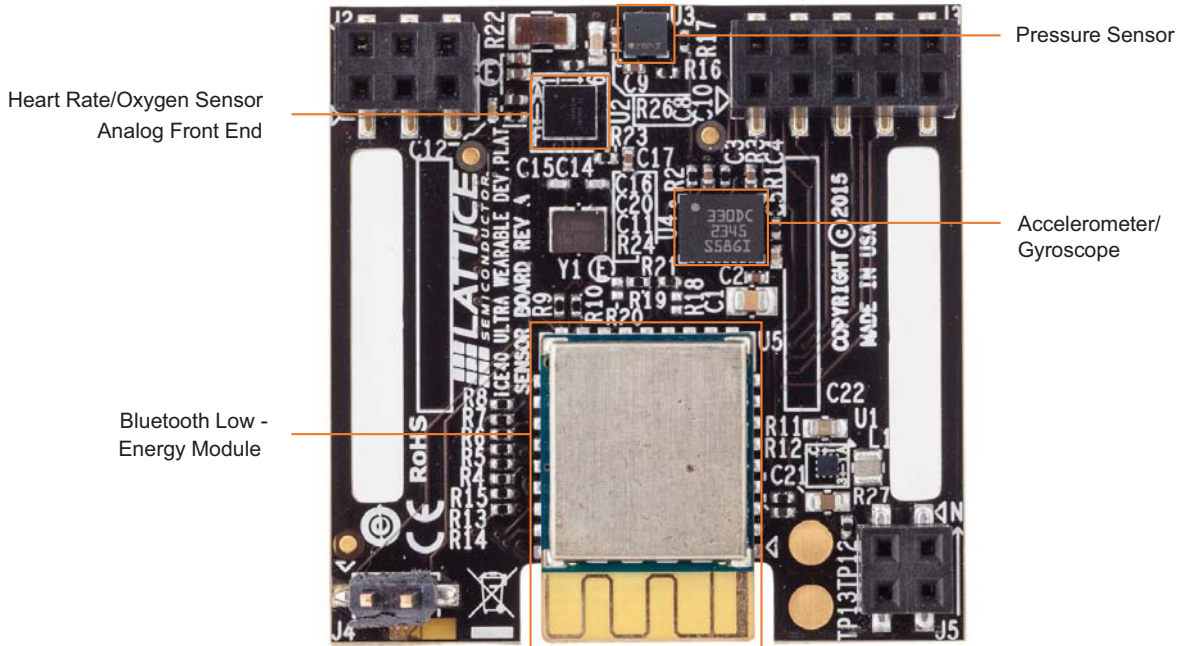
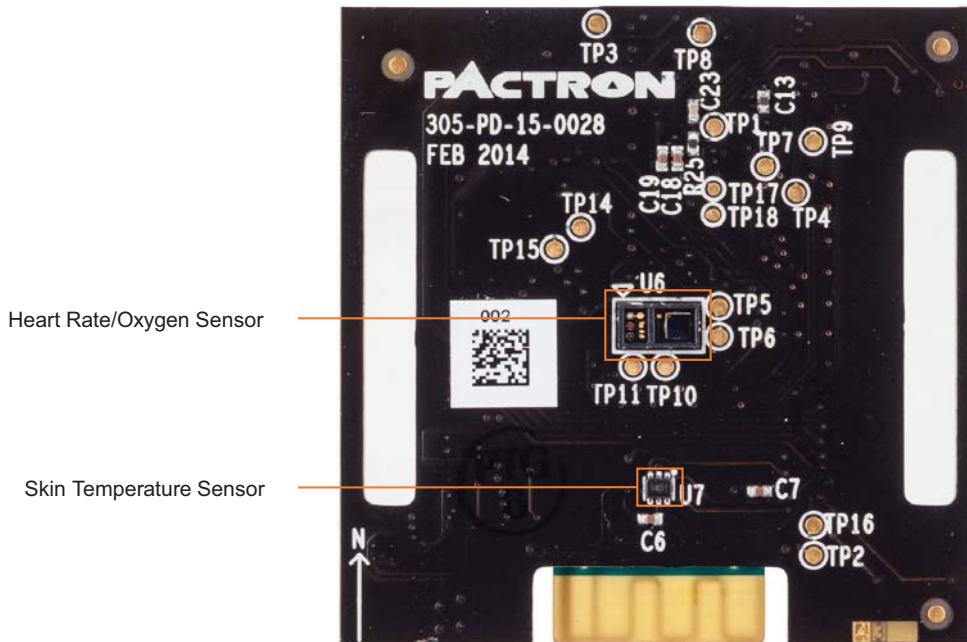

Figure 4. Sensor Board (Bottom Side)



## Lattice Semiconductor Devices

The Main Board features an iCE5LP4K and a MachXO2-2000ZE FPGA.

The iCE5LP4K has a 1.2 V core supply and is packaged in a 36-ball WLCSP package. For a complete description of this device, see DS1048, [iCE40 Ultra Family Data Sheet](#).

The MachXO2-2000ZE has a 1.2 V core supply and is packaged in a 49-ball WLCSP package. For a complete description of this device, see DS1035, [MachXO2 Family Data Sheet](#).

## Software Requirements

The following software must be installed before designs can be developed for this board:

- iCEcube2 2014-12 (or higher)
- Diamond® 3.4 (or higher)
- Diamond Programmer 3.4 (or higher)

This software is available at the Lattice website [Design Software & IP](#) page.

## Board Power

The Ultra Wearable Development Platform uses the USB connection as its primary source of power. It is also equipped with a battery and charger for use without a wired connection. A power switch (SW2) allows for the regulators to be disabled while allowing the battery to continue charging. Two status LEDs allow the battery charger to be monitored (see Table 12).

The battery charger and regulators are located on the Main Board. The battery attaches to the Sensor Board. Power is transferred between the two boards using the Power Connector header. See Table 2 for connections.

The VREG\_ADJ I/O supply net for the iCE5LP is adjustable, but is an internal, reserved feature. Changing this net from 3.3 V (default) to 1.8 V will cause voltage-level mismatches that can permanently damage the iCE5LP.

To allow current measurements to be made for specific supplies, resistors with test points have been inserted into the circuit. Refer to Table 1 to see which test points correspond to which supplies.

**Table 1. Supply Current Test Points**

Supply	TP+	TP-	Resistance
MachXO2 1.2 V	TP20	TP21	0.5 Ohms
MachXO2 3.3 V	TP18	TP19	0.5 Ohms
iCE5LP 1.2 V	TP20	TP33	0.5 Ohms
iCE5LP 3.3 V	TP18	TP32	0.5 Ohms
3.3 V Regulator	TP16	TP17	0.5 Ohms
Display 3 V	TP25	TP24	0.5 Ohms
Display 1.8 V	TP22	TP23	0.5 Ohms



## Headers

Four headers are used to connect the Main Board and the Sensor Board. The signals and connections are shown in the tables below:

**Figure 5. Headers**

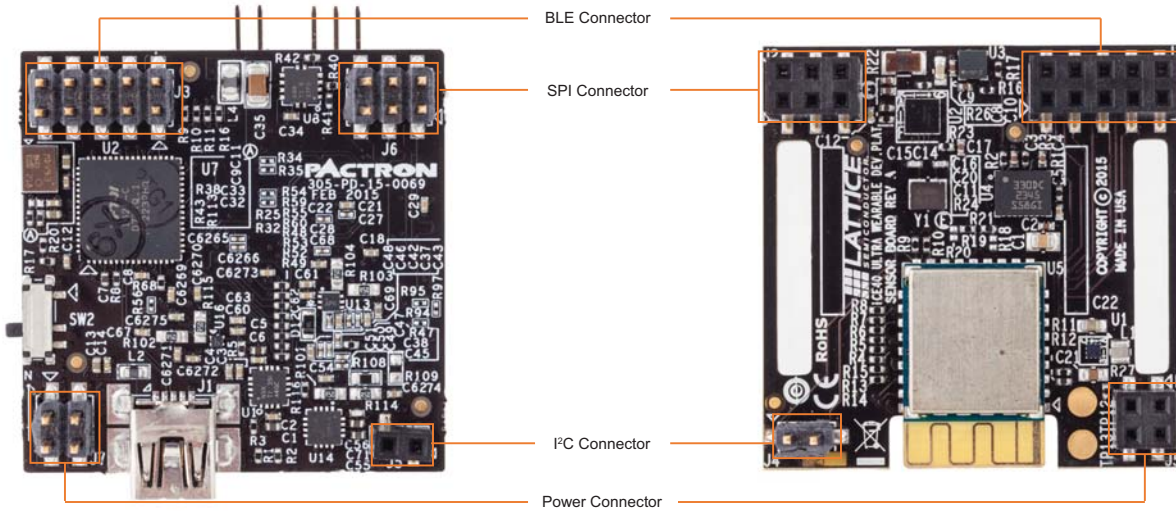

**Power Connector** (Main Board J7, Sensor Board J5): Power connection between the two boards

**Table 2. Power Connector**

Pin Number	Signal	Description
1	3V3	Regulated 3.3 V supply
2	BT_3V7	Unregulated ~3.7 V battery voltage
3	VREG_ADJ	Adjustable I/O Voltage (3.3 V default)
4	GND	Ground

**I2C Connector** (Main Board J5, Sensor Board): Interface for pressure sensor, temperature sensor, and accelerometer/gyroscope

**Table 3. I2C Connector**

Pin Number	Signal	iCE5LP Ball #
1	Sensor SCL	C1
2	Sensor SDA	E2

**SPI Connector** (Main Board J6, Sensor Board): Interface for the Analog Front-End of the Heart Beat/SpO2 sensor

**Table 4. SPI Connector**

Pin Number	Signal	iCE5LP Ball #
1	AFE SCLK	D6
2	AFE MISO	F6
3	AFE Ready	B5
4	AFE SS	D5
5	AFE MOSI	E6
6	GND	—

**BLE Connector** (Main Board J3, Sensor Board): Contains a UART connection to iCE5LP and a configuration SPI connection for the iCE5LP

**Table 5. BLE Connector**

Pin Number	Signal	Ball #
1	BLE Prog	MachXO2 G2
2	BLE SS	Config
3	BLE MISO	Config
4	BLE MOSI	Config
5	BLE SCLK	Config
6	CRSTb	—
7	CDONE	MachXO2 E3
8	UART Rx (out)	iCE5LP F5
9	UART Tx (in)	iCE5LP E5
10	GND	—

## Jumpers

The following jumpers can be used for adjusting board functionality:

- High-current LED select (J50): Controls whether the IR LED (1+2) or High-current White LED (2+3) is driven by the iCE5LP device
- FTDI Power (J51): To minimize power consumption and increase battery life, the FTDI programming chip can have its power supply cut-off by removing the jumper from J51. J51 must be in place prior to powering up in order to program the devices on this board.

## Test Points

Several test points have been included into the design to ease debug. Descriptions of these test points can be found below:

**Table 6. Main Board Test Points**

Test Point	Signal/Function
1	Configuration Signal: CResetn_FTDI
2	Configuration Signal: iCE_CDONE
3	Configuration Signal: FTDI_TCK (XO2)
4	Configuration Signal: FTDI_TDI (XO2)
5	Configuration Signal: FTDI_TDO (XO2)
6	Configuration Signal: FTDI_TMS (XO2)
11	Configuration Signal: JTAGEN (XO2)
12	Configuration Signal: PROGRAMN (XO2)
13	Configuration Signal: INITN (XO2)
16	Current Measurement (See Table 1)
17	Current Measurement (See Table 1)
18	Current Measurement (See Table 1)
19	Current Measurement (See Table 1)
20	Current Measurement (See Table 1)
21	Current Measurement (See Table 1)
22	Current Measurement (See Table 1)
23	Current Measurement (See Table 1)
24	Current Measurement (See Table 1)
25	Current Measurement (See Table 1)
28	Configuration Signal: FLASH_MISO (iCE)
29	Configuration Signal: FLASH_MOSI (iCE)
30	Configuration Signal: FLASH_CSB (iCE)
31	Configuration Signal: FLASH_SCLK (iCE)
32	Current Measurement (See Table 1)
33	Current Measurement (See Table 1)
34	3.3 V Regulator Output Control (See TPS7A7200)
35	3.3 V Regulator Output Control (See TPS7A7200)
36	3.3 V Regulator Output Control (See TPS7A7200)



**Table 7. Sensor Board Testpoints**

Test Point	Signal/Function
1	AFE4403: CLKOUT
2	BLE Config: SWCLK
3	LPS25H: INT1
4	AFE4403: TX3
5	AFE4403: INN
6	AFE4403: INP
7	AFE4403: ADC_RDY
8	AFE4403: LED_DRV_SUP
9	AFE4403: VCM
10	AFE4403: TXP
11	AFE4403: TXN
12	Battery Connector (+)
13	Battery Connector (-)
14	LSM330DLC: INT1_G
15	LSM330DLC: INT2_G
16	BLE Config: SWDIO
17	AFE4403: Manual Reset, short to TP18
18	AFE4403: Manual Reset, short to TP17

### Device Interconnects

Six general purpose connections have been made between Lattice MachXO2 and iCE5LP devices for communication between FPGAs. Level translators have been implemented on these lines, which limit their operation frequency. Table 8 lists connection ports and maximum operation frequencies:

**Table 8. MachXO2 and iCE5LP Interconnections**

Net Number	MachXO2 Ball	iCE5LP Ball	Max Frequency
1	E6	C2	20 MHz
2	E5	B1	20 MHz
3	D5	D2	100 MHz
4	D4	B2	100 MHz
5	G4	B4	100 MHz
6	F4	F4	100 MHz

## Display

The Ultra Wearable Development Platform includes an LG LH154Q01 Display and necessary driving circuitry. MIPI DSI clock and data signals are driven by the Lattice MachXO2 device, through a resistor network for achieving proper voltage levels. This display also provides a frame-sync signal, B\_Sync, which is routed to a MachXO2 pin. Display supplies and the backlight driver are controlled by outputs from the MachXO2.

**Table 9. Display Signals**

Signal	MachXO2 Ball	I/O Type
Clock HS+	C4	LVDS25
Clock HS-	D3 (Auto)	LVDS25 (Auto)
Clock LP+	C7	LVC MOS12
Clock LP-	C6	LVC MOS12
Data HS+	C1	LVDS25
Data HS-	D2 (Auto)	LVDS25 (Auto)
Data LP+	A7	LVC MOS12
Data LP-	B6	LVC MOS12
Reset	B2	LVC MOS33
B_Sync	A3	LVC MOS33
Backlight PWM	C3	LVC MOS33
3 V Enable	C2	LVC MOS33
1.8 V Enable	E2	LVC MOS33

*Note: For the high-speed differential signals (Clock HS, Data HS) only the positive channel must be assigned, the negative channel will be automatically placed.*

## Clock Sources

The Main Board has a single 27 MHz clock source that connects to the Lattice MachXO2 device. To use this external clock with the iCE5LP device, the 27 MHz clock can be routed from the MachXO2 via one of the six general purpose interconnects. These connections can be found in Table 8.

**Table 10. Clock Sources**

Source	Frequency	XO2 Ball	iCE Ball
Oscillator	27 MHz	E4	—

## Reset Button

A button (SW1) is included for performing resets of systems on board the Ultra Wearable Development Platform. By default, this button will perform a configuration reset of the iCE5LP and the Bluetooth module. Reset functionality can be added to the MachXO2 by inserting a resistor as described below:

**Table 11. Reset Resistors and Pins**

Device	Resistor	FPGA Ball
MachXO2	R110	B3
iCE5LP	R62	—
Seed BLE	R63	—

*Note: If VREG\_ADJ (See Board Power section) is changed, R62 and R63 must be removed.*

## LEDs

The Main Board has four system status LEDs, two user LEDs, an RGB LED, an IR LED, and a flashlight LED. These functions are detailed below:

**Table 12. Main Board LEDs**

LED Number	XO2 Ball	iCE Ball	Function
D1	—	—	Power Source Connected
D2	—	—	Battery Charging
D3	Config	—	XO2 CDONE
D4	E7	—	User LED
D5	F7	—	User LED
D8	—	Config	iCE CDONE
D9 (R)	—	C6	RGB LED (Red)
D9 (G)	—	B6	RGB LED (Green)
D9 (B)	—	A6	RGB LED (Blue)
D10	—	A2*	IR LED (See Jumpers Section)
D11	—	A2*	Flashlight LED (See Jumpers Section)

## Sensors and Peripherals

The Ultra Wearable Development Platform utilizes several third-party devices. Links for more information can be found below:

**Table 13. Main Board Sensors and Peripherals**

Name	Reference Number	Interface	FPGA Connections	Part Number	Link
Microphone	U6, U7	I2S	iCE5LP: Clock (F3), Data (E3)	MP34DB01	<a href="http://www.st.com/web/en/catalog/sense_power/FM125/SC1564/PF250941">http://www.st.com/web/en/catalog/sense_power/FM125/SC1564/PF250941</a>

**Table 14. Sensor Board Sensors and Peripherals**

Name	Reference Number	Interface	FPGA Connections	Part Number	Link
Temperature Sensor	U7	I2C	See Table 3	TMP112	<a href="http://www.ti.com/product/tmp112">http://www.ti.com/product/tmp112</a>
Pressure Sensor	U3	I2C	See Table 3	LPS25H	<a href="http://www.st.com/web/catalog/sense_power/FM89/SC1316/PF255230">http://www.st.com/web/catalog/sense_power/FM89/SC1316/PF255230</a>
Accelerometer/ Gyroscope	U4	I2C	See Table 3	LSM330DLC	<a href="http://www.st.com/web/en/catalog/sense_power/FM89/SC1448/PF252427">http://www.st.com/web/en/catalog/sense_power/FM89/SC1448/PF252427</a>
Heart Rate & Oxygen Sensor	U6	—	—	SFH7050	<a href="http://www.osram-os.com/osram_os/en/products/product-promotions/infrared-products/sensor-family/biomon-sensor-sfh-7050/index.jsp">http://www.osram-os.com/osram_os/en/products/product-promotions/infrared-products/sensor-family/biomon-sensor-sfh-7050/index.jsp</a>
Analog Front End	U2	SPI	See Table 4	AFE4403	<a href="http://www.ti.com/product/afe4403">http://www.ti.com/product/afe4403</a>
BLE Module	U5	UART	See Table 5	Seeed 113050012	<a href="http://www.seeedstudio.com/wiki/BLE_Micro">http://www.seeedstudio.com/wiki/BLE_Micro</a>

## Flash Memory Devices

The Lattice MachXO2 and iCE5LP are each equipped with an external SPI Flash memory device.

**Table 15. Flash Devices**

Master Device	Reference Number	Part Number
MachXO2	U5	Micron N25Q032A13ESC40G
iCE5LP	U10	Micron M25P80-VMN6TP

The iCE5LP external Flash memory is intended for holding configuration data, while the MachXO2 external Flash memory is intended for storing data, such as images for the included display. Because of the target application, the Flash device connected to the MachXO2 is capable of using the higher-bandwidth Quad-SPI protocol.

**Table 16. Flash Connections**

Master Device	Reference Number	Signal	FPGA Ball
MachXO2	U5	DQ0	G1
		DQ1	F5
		DQ2	F3
		DQ3	G3
		SCLK	F6
		CS	G7
iCE5LP	U10	MISO	F2
		MOSI	D1
		SCLK	E1
		CS	F1

## Board Configuration and Programming

### Lattice MachXO2

The Lattice MachXO2 features internal configuration Flash. This allows configuration data to be stored internally while the external Flash memory device is used for auxiliary functions.

1. Ensure that header J51 is shunted and the power switch (SW2) is in the *on* position.
2. Plug in the mini-USB cable (J1).
3. Launch Diamond Programmer.
4. Select **Create a new project from a scan** and click **Detect Cable**.
5. Select the FTUSB-1 Port.
6. Select **MachXO2** and **LCMXO2-2000ZE** in the Device Family and Device columns.
7. Double click on the Operation column and select the appropriate operation.
  - a. Internal Flash: Flash Programming Mode: SPI Flash Erase, Program, Verify
  - b. External Flash: SPI Flash Programming: SPI Flash Erase, Program, Verify
8. If targeting the External Flash memory, copy the SPI Flash Options from Figure 6.
9. Select the programming bitstream in the “File Name” column.
10. Click the Program Icon or select Program from the Design dropdown menu.

Figure 6. MachXO2 External Flash

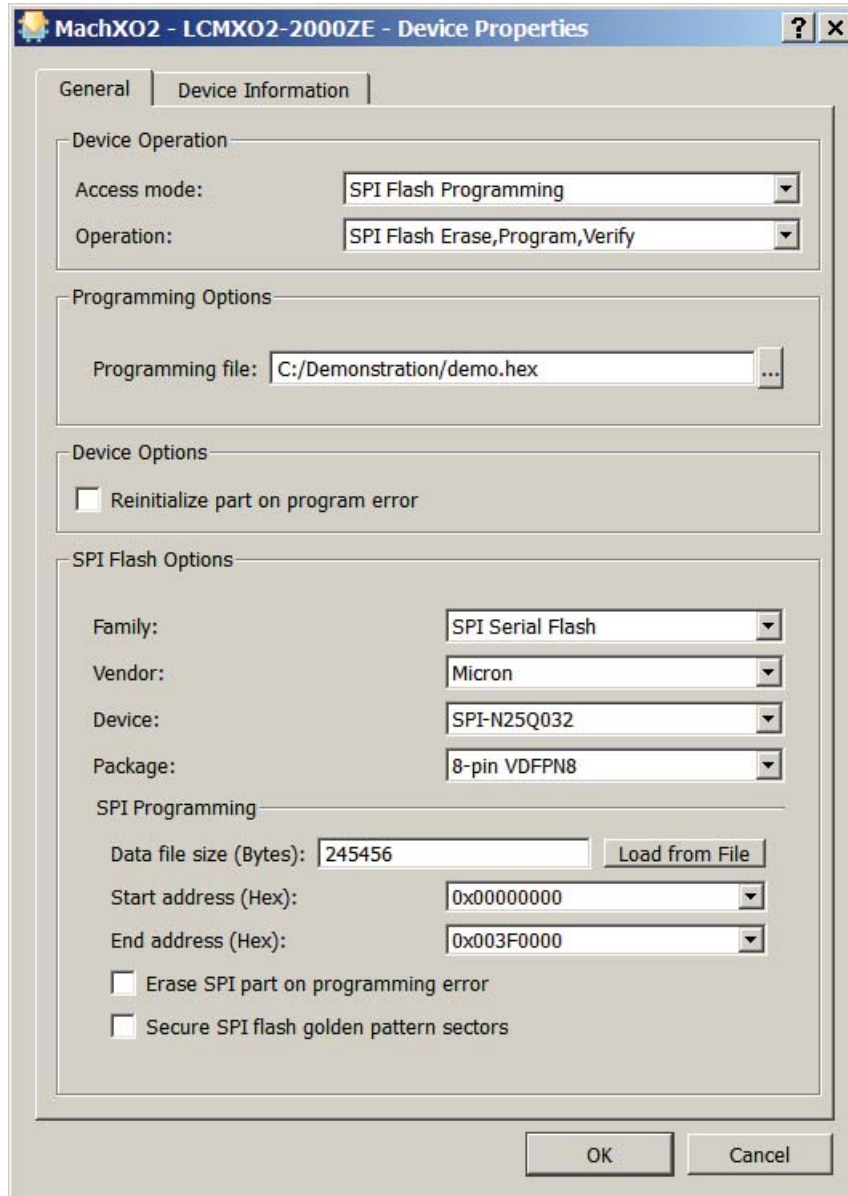

## Lattice iCE5LP

The Lattice iCE5LP can be directly programmed, however, unless single-time programmable NVCM is used, the configuration data will be lost when the device is powered down.

1. Ensure that header J51 is shunted and the power switch (SW2) is in the *on* position.
2. Plug in the mini-USB cable (J1).
3. Launch Diamond Programmer.
4. Select **Create a new project from a scan** and click **Detect Cable**.
5. Select the FTUSB-0 Port.
6. Select **iCE5LP** and **iCE5LP4K** in the Device Family and Device columns.



7. Double click on the Operation column and select the appropriate operation
  - a. Direct Program: CRAM Programming: Fast Program (Volatile)
  - b. NVCM (Single-use): NVCM Programming Mode: NVCM Program, Verify, Secure
  - c. External Flash: SPI Flash Programming: SPI Flash Erase, Program, Verify
8. If targeting the External Flash memory, copy the SPI Flash Options from Figure 7.
9. Select the programming bitstream in the File Name column
10. Click the Program Icon or select Program from the Design dropdown menu

**Figure 7. iCE5LP External Flash**

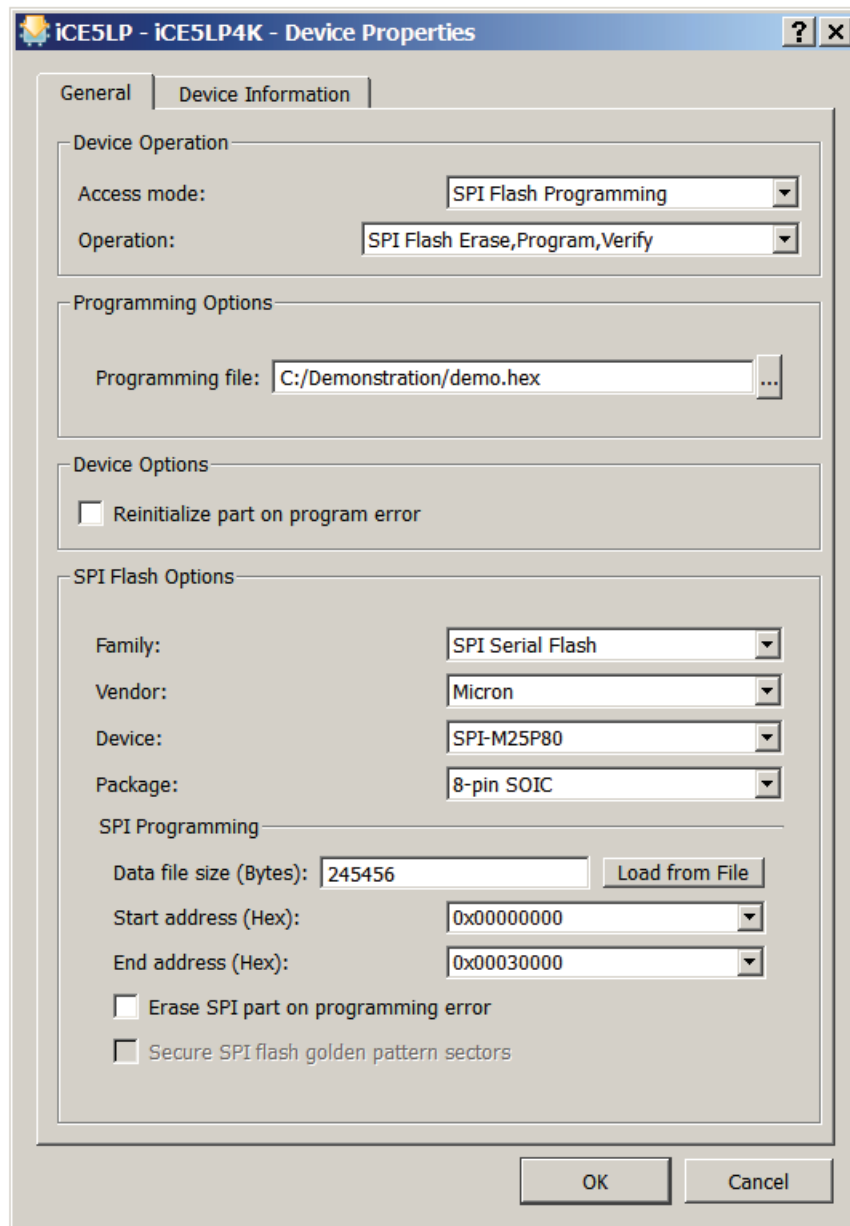

## Pre-Loaded Demonstration Design

The Ultra Wearable Development Platform comes pre-loaded with the Parallel-to-MIPI DSI demo. In order to run the demo, follow these steps:

1. Ensure that the display is attached in the proper orientation, with the connector ribbon extending toward the right edge of the device (see Figure 8).

**Figure 8. Display Connector**

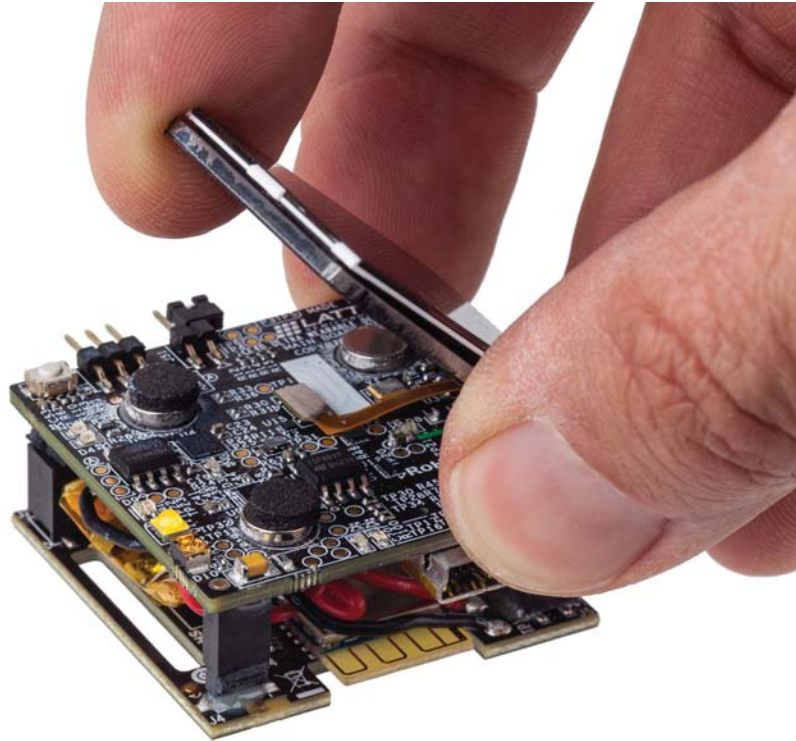

2. Plug a mini-USB cable into the mini-USB port (J1) to supply power to the device.
3. Switch power switch to the *on* position.
4. The screen should alternate between two images, with the User LEDs (D4, D5) indicating the demo mode.

For more detailed operation instructions, please refer to the Quick Start User Guide included with the demo design.

This demo design can be reprogrammed onto the board by downloading the project (see [Additional Demonstration Designs](#) section) and following the documented instructions. Please note that in this demo, the MachXO2 uses its internal Flash to store configuration data and the external Flash to store image data, so two programming procedures must be performed.

## Additional Demonstration Designs

Several additional demonstration designs have been developed for the Ultra Wearable Development Platform. These designs can be found under the Design File Tab of the Documentation section of the board web page here: <http://www.latticesemi.com/ultrawearable>.

## Ordering Information

Description	Ordering Part Number	China RoHS Environment-Friendly Use Period (EFUP)
Ultra Wearable Development Platform	ICE5LP4K-WDEV-EVN	

## Technical Support Assistance

Submit a technical support case via [www.latticesemi.com/techsupport](http://www.latticesemi.com/techsupport).

## Revision History

Date	Version	Change Summary
June 2015	1.0	Initial release.

© 2015 Lattice Semiconductor Corp. All Lattice trademarks, registered trademarks, patents, and disclaimers are as listed at [www.latticesemi.com/legal](http://www.latticesemi.com/legal). All other brand or product names are trademarks or registered trademarks of their respective holders. The specifications and information herein are subject to change without notice.

## Appendix A. Main Board Schematic Diagrams

Figure 9. Block Diagram

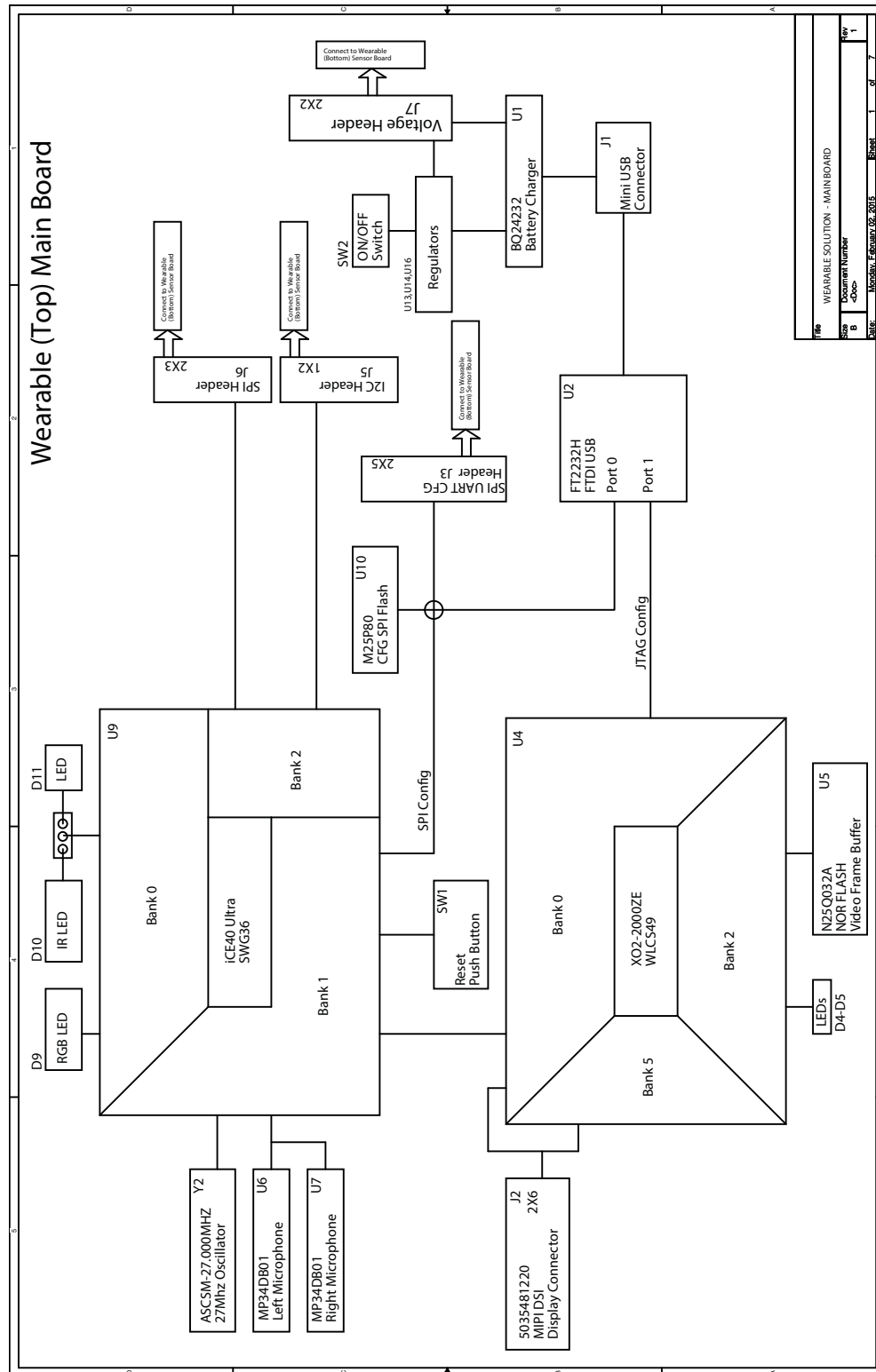

Figure 10. Mechanical Design

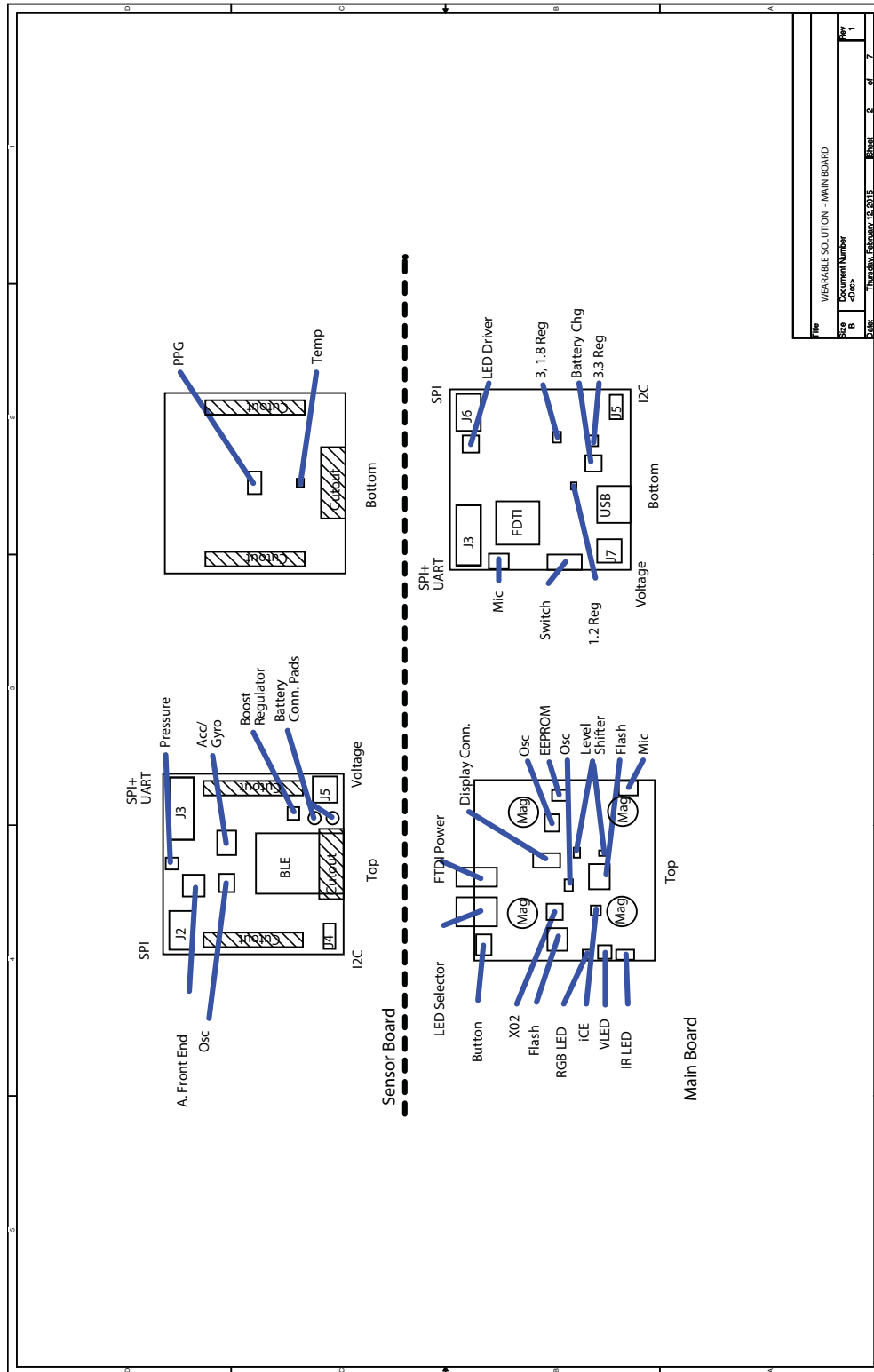

Figure 11. Battery Charger Connections

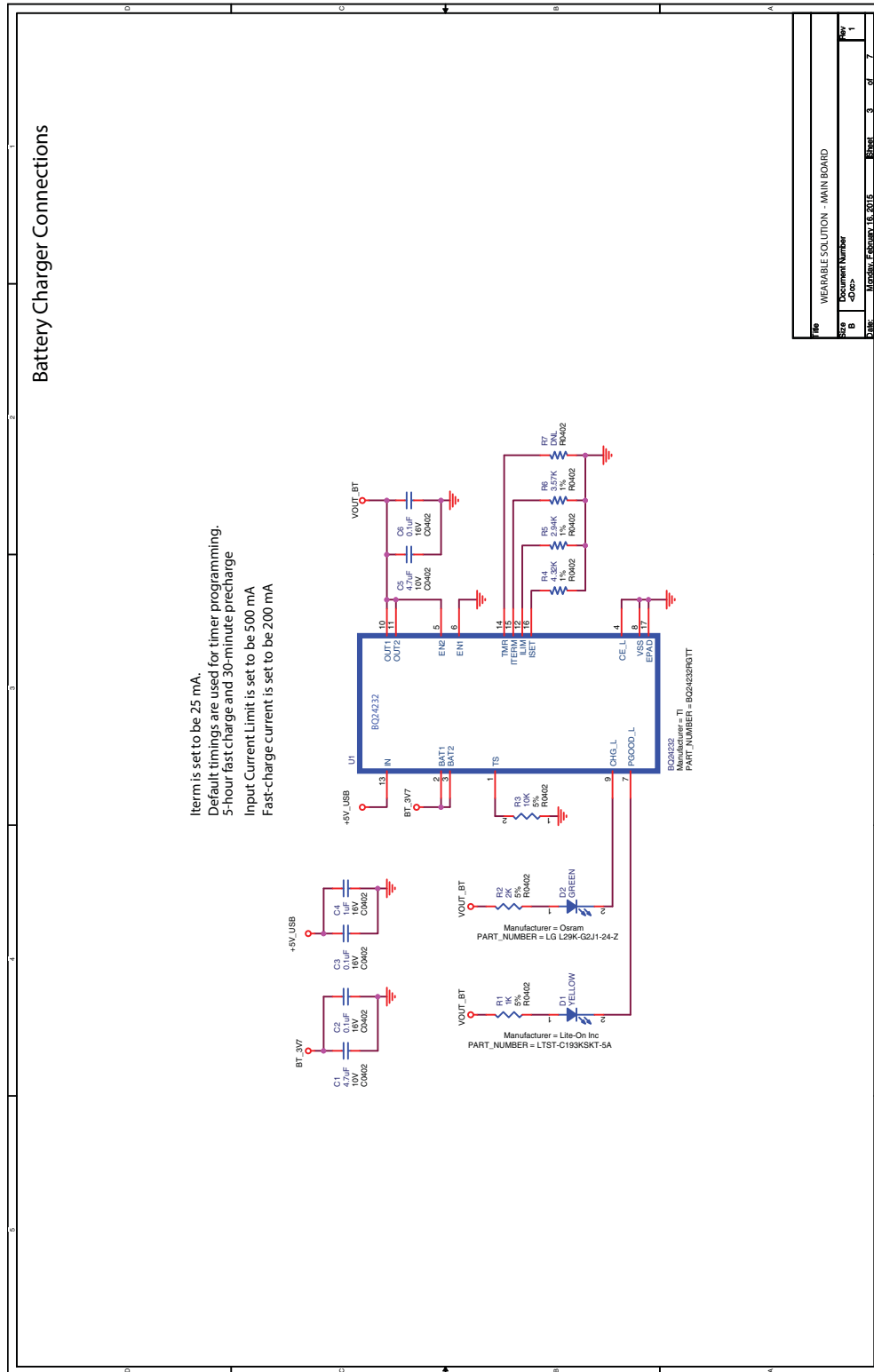





Figure 13. MachXO2-2002ZE Connections

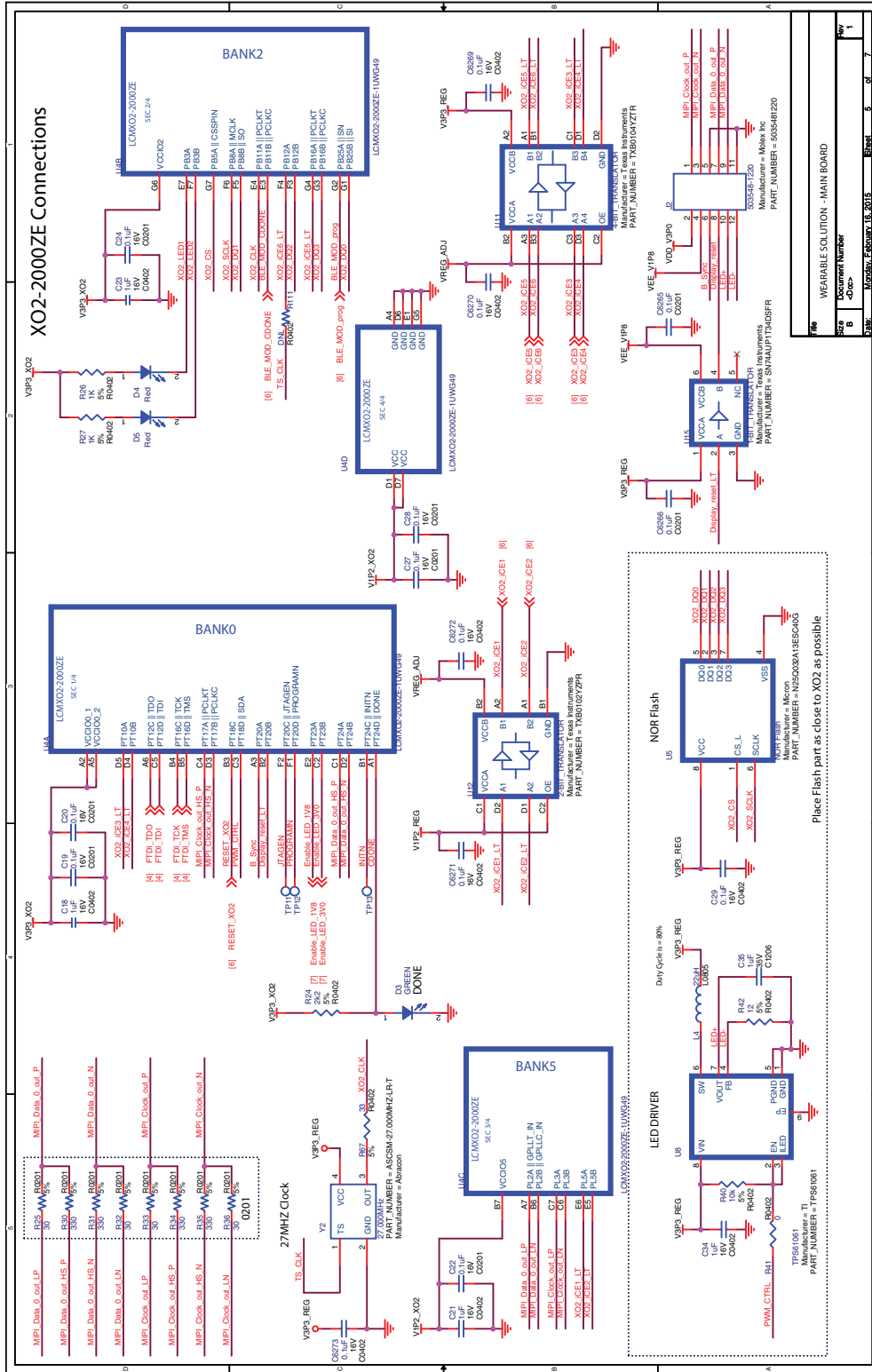
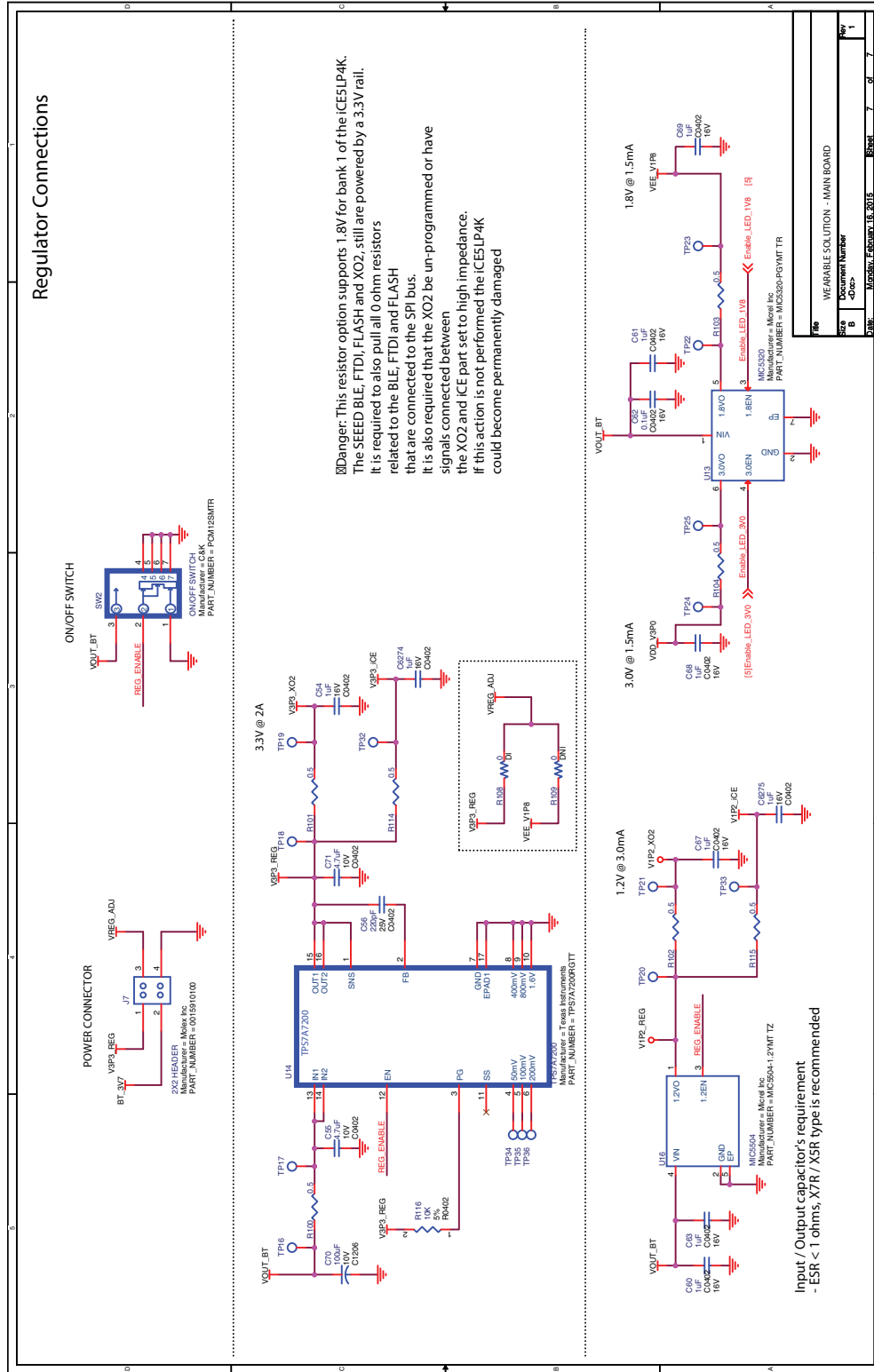



Figure 15. Regulator Connections



## Appendix B. Sensor Board Schematic Diagrams

Figure 16. Block Diagram

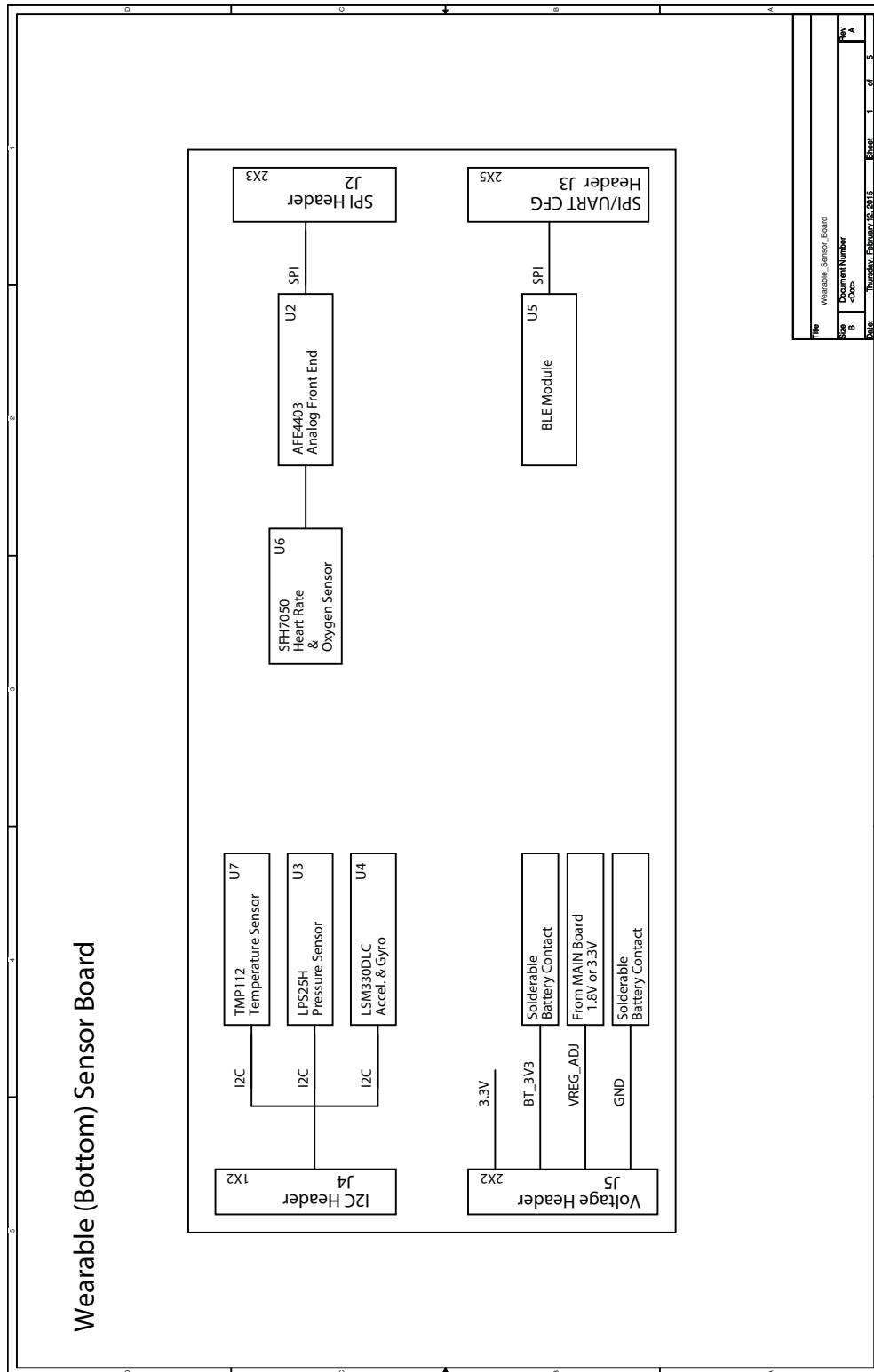

Figure 17. Mechanical Design

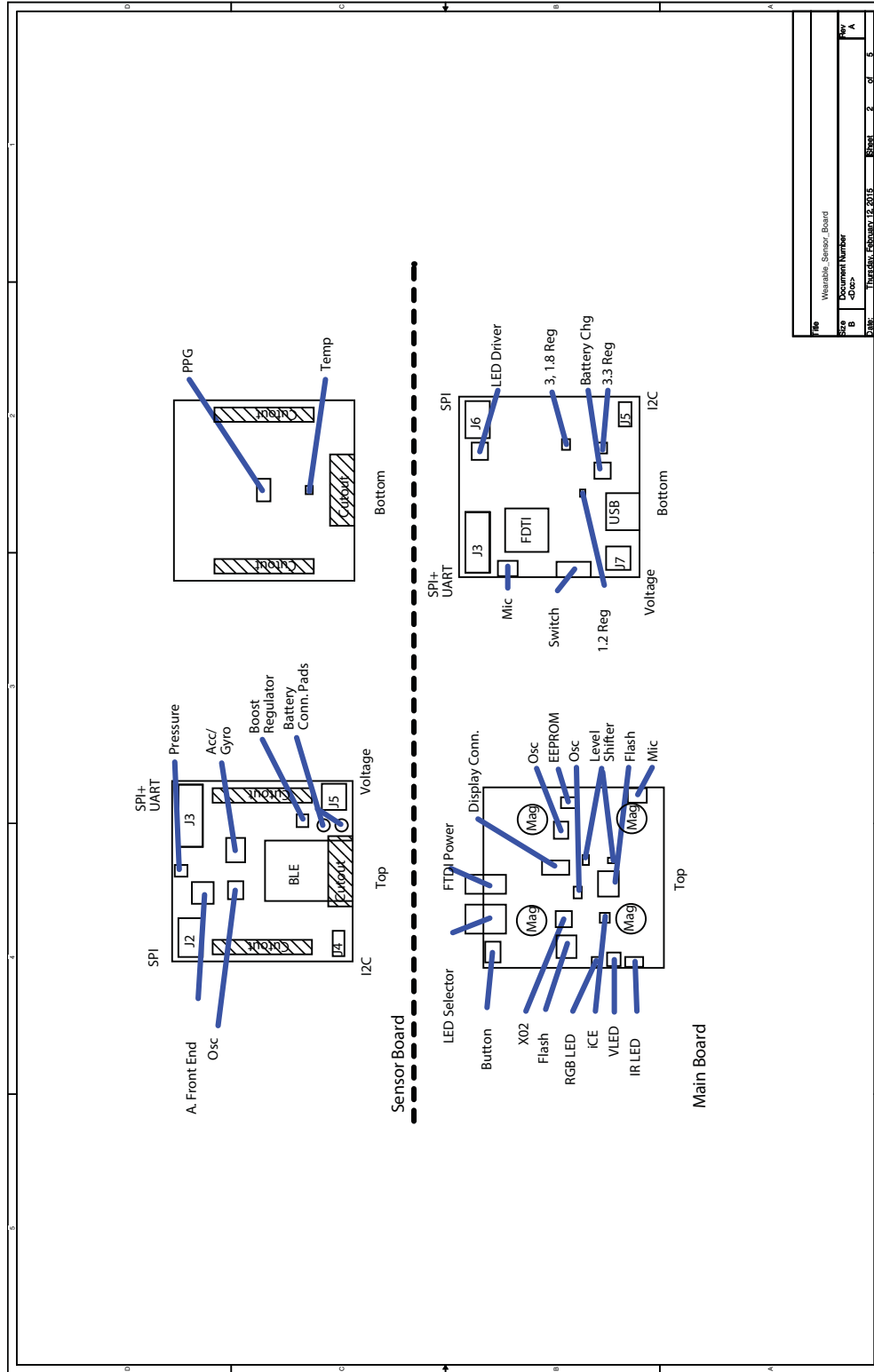



Figure 18. Sensor Connections - 1

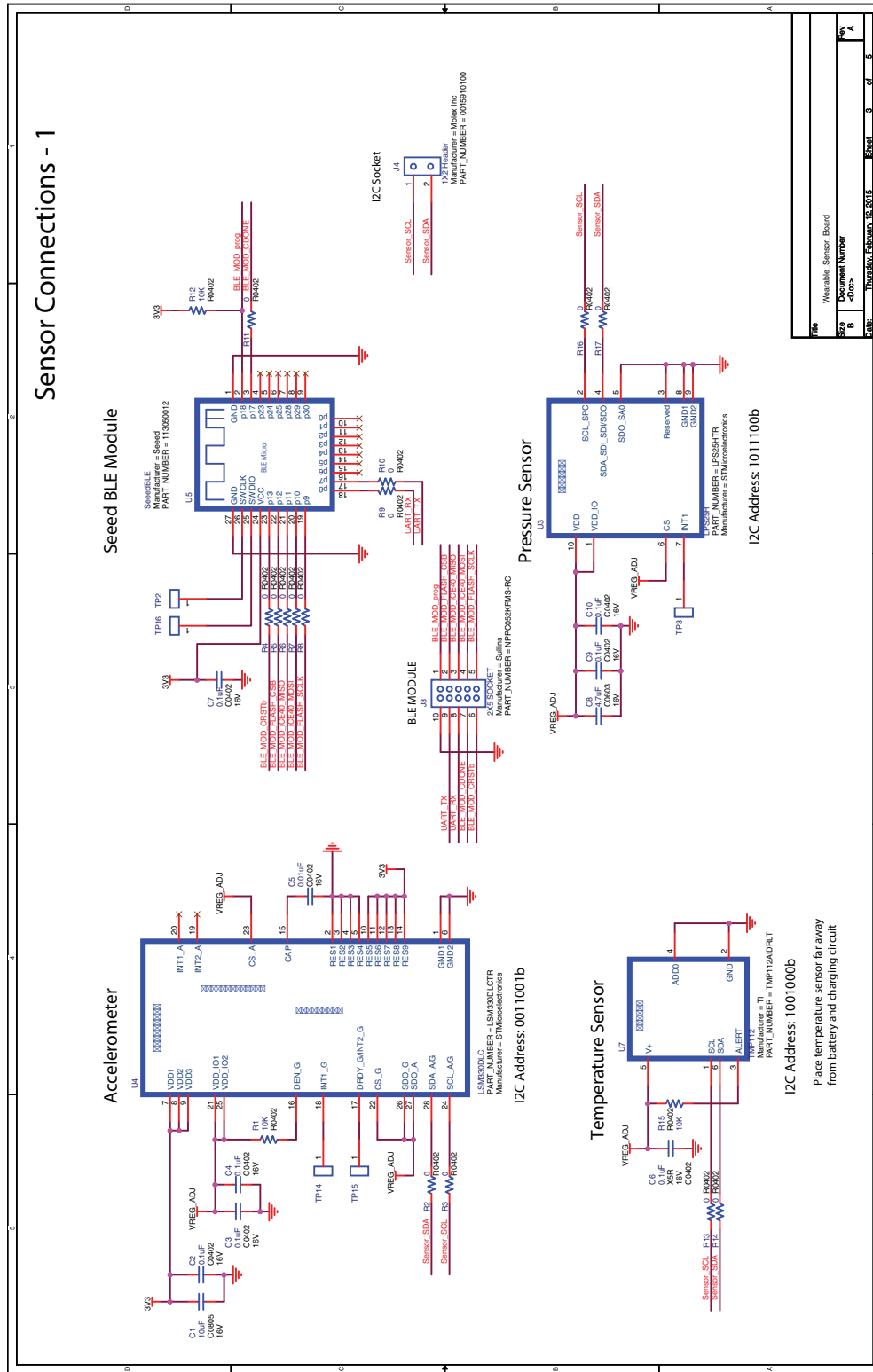
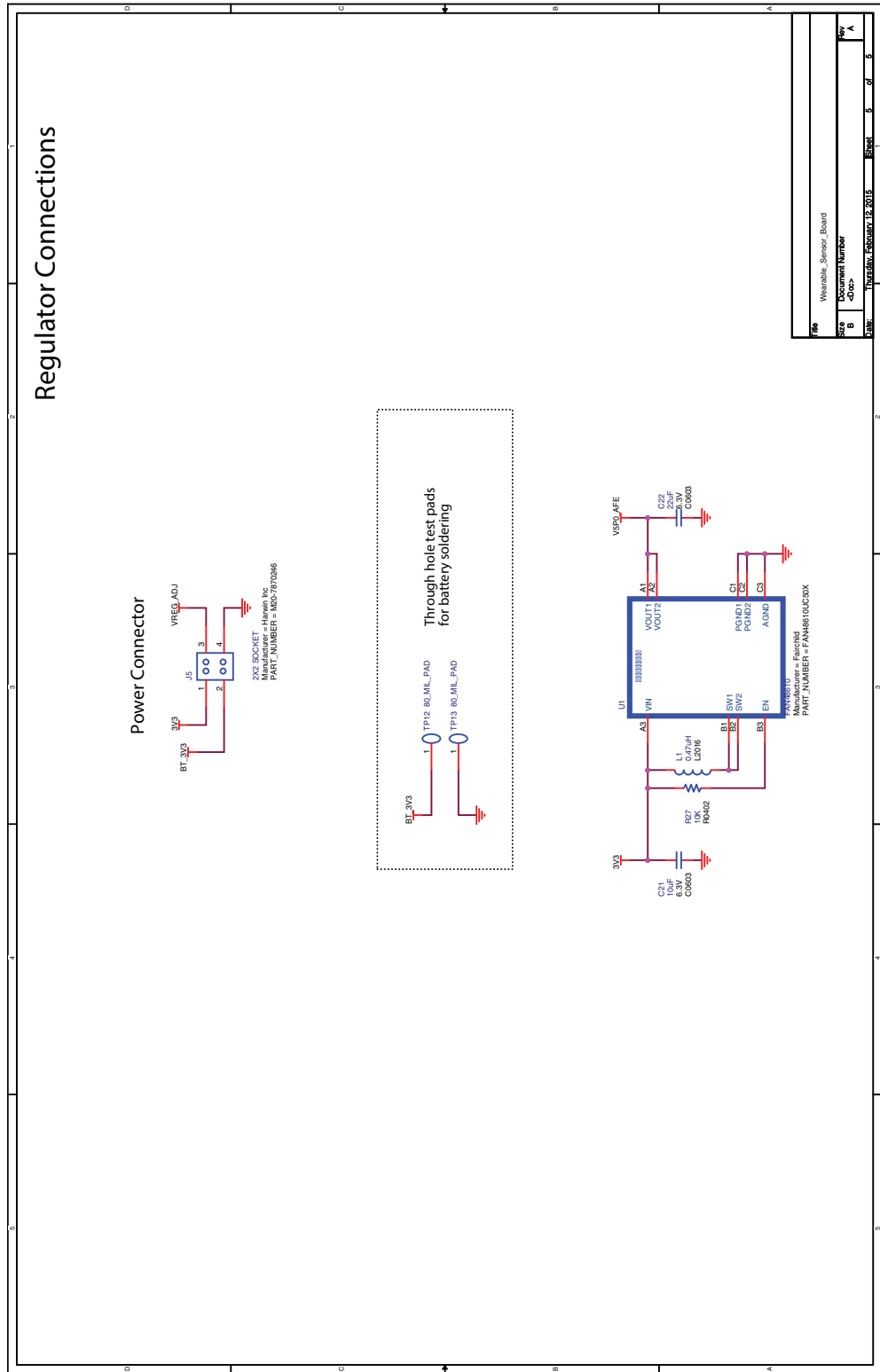



Figure 20. Boost Regulator



## Appendix C. Main Board Bill of Materials

Figure 21. Main Board Bill of Materials

Item	Reference	Qty	Part	PCB Footprint	Part Number	Manufacturer	Description
1	C1,C5,C55	3	4.7 uF	C0402	C1005X5R1A475K050BC	TDK	CAP CER 4.7UF 10V 10% X5R 0402
2	C2,C3,C6,C6269,C6270,C6271,C6272	7	0.1 uF	C0402	C1005X5R1C104K050BA	TDK	CAP CER 0.1UF 16V 10% X5R 0402
3	C4	1	1 uF	C0402	GRM155R61C105KE01D	Murata	CAP CER 1UF 16V 10% X5R 0402
4	C7	1	4.7 uF	C0402	C1005X5R1A475K050BC	TDK	CAP CER 4.7UF 10V 10% X5R 0402
5	C8,C9,C10,C12,C14,C17,C29,C31,C33,C36,C53,C62,C6273	13	0.1 uF	C0402	C1005X5R1C104K050BA	TDK	CAP CER 0.1UF 16V 10% X5R 0402
6	C11,C13,C30,C32	4	10 uF	C0402	CL05A106MP5NUNC	Samsung	CAP CER 10UF 10V 20% X5R 0402
7	C15,C16	2	27 pF	C0402	CL05C270JB5NNNC	Samsung	CAP CER 27PF 50V 5% NP0 0402
8	C18,C23,C34,C41,C43,C46,C51,C54,C60,C61,C63,C67,C68,C69,C6274,C6275	16	1 uF	C0402	GRM155R61C105KE01D	Murata	CAP CER 1UF 16V 10% X5R 0402
9	C19,C20,C21,C22,C24,C27,C28,C40,C42,C44,C45,C47,C50	13	0.1 uF	C0201	C0603X5R1C104K030BC	TDK	CAP CER 0.1UF 16V 10% X5R 0201
10	C35	1	1 uF	C1206	GMK316BJ105KLHT	Taiyo Yuden	CAP CER 1UF 35V 10% X5R 1206
11	C37,C38,C39,C48,C49	5	10 nF	C0201	GRM033R61C103KA12D	Murata	CAP CER 10000PF 16V 10% X5R 0201
12	C56	1	0.01 uF	C0402	GRM155R61C103KA01D	Murata	CAP CER 10000PF 16V 10% X5R 0402
13	C6265,C6266	2	0.1 uF	C0201	C0603X5R1E104M030BB	TDK Corporation	CAP CER 0.1UF 25V 20% X5R 0201
14	D1	1	YELLOW	LED0603	LTST-C193KSKT-5A	Lite-On Inc	LED YELLOW RECT CLEAR 0603
15	D2	1	GREEN	LED0603	LG L29K-G2J1-24-Z	Osram	LED SMARTLED GREEN 570NM 0603
16	D3,D8	2	GREEN	LED0603	LG L29K-G2J1-24-Z	Osram	LED SMARTLED GREEN 570NM 0603
17	D4,D5	2	Red	LED0603	LTST-C190KRKT	LITE-ON INC	LED SUPER RED CLEAR 0603 SMD
18	D6	1	SCHOTTKY	BAT54KFILM_SOD523	BAT54KFILM	STMicroelectronics	DIODE SCHOTTKY 40V 0.3A SOD523
19	D9	1	TRICOLOUR_LED	APTF1616SE_RGB	APTF1616SEEZQBDC	Kingbright	LED RED/GREEN/BLUE WTR CLEAR SMD
20	D10	1	IR_LED	SFH4645_2SMD	SFH 4645	OSRAM	EMITTER 950NM MIDLED SIDEK SMD
21	D11	1	LED	XBDAWT_2SMD	XBDAWT-00-0000-00000LCE3	Cree Inc	LED HIGH BRIGHTNESS
22	D12	1	CDBU0520	DIODE_SOD523F	CDBU0520	Comchip	DIODE SCHOTTKY 20V 500MA 0603
23	J1	1	USB PWR	CONN_S5P1RMINIUSBB_MOL EX	67503-1020	Molex	CONN RECEPT MINI-USB R/A 5POS SMD
24	J2	1	503548-1220	2X6HDR_5035481220	5035481220	Molex Inc	CONN RCPT BTB 12POS DL VERT SMD
25	J3	1	2x5 HEADER	2X5_HDR803_SMD	803-43-010-30-001000	Mill-Max	CONN SOCKET DBL 10POS .100" SMD
26	J5	1	1X2 HEADER	1X2_HDR349_SMD	349-10-102-00-560000	Mill-Max	CONN HEADER 2POS SMD SNGL ROW
27	J6	1	2X3 HEADER	2X3_HDR803_SMD	803-43-006-30-001000	Mill-Max	CONN SOCKET DBL 6POS .100" SMD
28	J7	1	2X2 HEADER	2X2_HDR803_SMD	803-43-004-30-001000	Mill-Max	CONN SOCKET DBL 4POS .100" SMD
29	J50	1	1X3 R/A HEADER	1X3_HDRRA_2MM	951103-7622-AR	3M	CONN HEADER 3POS 2MM R/A T/H
30	J51	1	1X2 HEADER_RT_ANGLE	1X2_HDR803_SMD	830-10-002-40-028000	Mill-Max	CONN HDR 2POS .100 HORIZ SMD
31	L1,L2,L3	3	600ohm, 500mA	L0603	MMZ1608R601A	TDK Corp	FERRITE CHIP 600 OHM 500MA 0603
32	L4	1	22 uH	L0805	AIML-0805HC-220M-T	Abracon Corporation	HIGH CURRENT CHIP IND 22.0UH 20%
33	L5	1	2.2 uH	L1008	MAMK2520T2R2M	Taiyo Yuden	FIXED IND 2.2UH 1.9A 117 MOHM

Item	Reference	Qty	Part	PCB Footprint	Part Number	Manufacturer	Description
34	R1,R2	2	1K	R0402	ERJ-2GEJ102X	Panasonic	RES SMD 1K OHM 5% 1/10W 0402
35	R3	1	10K	R0402	ERJ-2GEJ103X	Panasonic	RES SMD 10K OHM 5% 1/10W 0402
36	R4	1	4.32K	R0402	ERJ-2RKF4321X	Panasonic	RES SMD 4.32K OHM 1% 1/10W 0402
37	R5	1	2.94K	R0402	ERJ-2RKF2941X	Panasonic	RES SMD 2.94K OHM 1% 1/10W 0402
38	R6	1	3.57K	R0402	ERJ-2RKF3571X	Panasonic	RES SMD 3.57K OHM 1% 1/10W 0402
39	R7	1	DNL	R0402	-	-	-
40	R8	1	12k	R0402	ERJ-2GEJ123X	Panasonic	RES SMD 12K OHM 5% 1/10W 0402
41	R9,R10,R11	3	4.7K	R0402	ERJ-2GEJ472X	Panasonic	RES SMD 4.7K OHM 5% 1/10W 0402
42	R12,R13,R14,R15, R37,R43,R112,R113	8	0	R0402	ERJ-2GE0R00X	Panasonic	RES SMD 0.0 OHM JUMPER 1/10W 0402
43	R16,R26,R27,R44	4	1K	R0402	ERJ-2GEJ102X	Panasonic	RES SMD 1K OHM 5% 1/10W 0402
44	R17,R18,R19,R40, R45,R46,R61	7	10k	R0402	ERJ-2GEJ103X	Panasonic	RES SMD 10K OHM 5% 1/10W 0402
45	R20,R68	2	2.2k	R0402	ERJ-2GEJ222X	Panasonic	RES SMD 2.2K OHM 5% 1/10W 0402
46	R24	1	2k2	R0402	ERJ-2GEJ222X	Panasonic	RES SMD 2.2K OHM 5% 1/10W 0402
47	R25,R32,R33,R36	4	30	R0201	ERJ-1GEJ300C	Panasonic	RES 30 OHM 1/20W 5% 0201 SMD
48	R30,R31,R34,R35	4	330	R0201	CRCW0201330RJNED	Vishay	RES 330 OHM 1/20W 5% 0201 SMD
49	R38,R39	2	DNL	R0402	-	-	-
50	R41	1	0	R0402	ERJ-2GE0R00X	Panasonic	RES SMD 0.0 OHM JUMPER 1/10W 0402
51	R42	1	12	R0402	ERJ-2GEJ120X	Panasonic	RES SMD 12 OHM 5% 1/10W 0402
52	R47	1	100	R0402	ERJ-2RKF1000X	Panasonic	RES SMD 100 OHM 1% 1/10W 0402
53	R48,R49,R50,R51, R52,R53,R54,R55, R57,R58,R59,R60, R62,R63	14	0	R0201	ERJ-1GN0R00C	Panasonic	RES SMD 0.0 OHM JUMPER 1/20W 0201
54	R56	1	1K	R0201	ERJ-1GEJ102C	Panasonic	RES SMD 1K OHM 5% 1/20W 0201
55	R67	1	33	R0402	ERJ-2GEJ330X	Panasonic	RES SMD 33 OHM 5% 1/10W 0402
56	R94,R95,R97	3	0	R0201	ERJ-1GN0R00C	Panasonic	RES SMD 0.0 OHM JUMPER 1/20W 0201
57	R100,R101,R102, R103,R104,R114,R115	7	0.5	Current_Sens_Res_0603	RL0603FR-070R5L	Yageo	RES SMD 0.5 OHM 1% 1/10W 0603
58	R106,R107	2	10k	R0201	ERJ-1GEJ103C	Panasonic	RES SMD 10K OHM 5% 1/20W 0201
59	R108,R109	2	0	R0603	ERJ-3GEY0R00V	Panasonic	RES SMD 0.0 OHM JUMPER 1/10W 0603
60	R110,R111	2	DNL	R0201	-	-	-
61	R116	1	49.9K	R0402	ERJ-2RKF4992X	Panasonic	RES SMD 49.9K OHM 1% 1/10W 0402
62	R117	1	15.8K	R0402	ERJ-2RKF1582X	Panasonic	RES SMD 15.8K OHM 1% 1/10W 0402
63	SW1	1	PB	2psmd_eswitch	TL1015AF160QG	E-Switch	SWITCH TACTILE SPST-NO 0.05A 12V
64	SW2	1	ON/OFF SWITCH	PCM12SMTR	PCM12SMTR	C&K	SWITCH SLIDE SPDT 300MA 6V
65	TP1,TP2,TP3,TP4, TP5,TP6,TP11,TP12, TP13,TP16,TP17, TP18,TP19,TP20, TP21,TP22,TP23, TP24,TP25,TP32, TP33	21	T POINT R	TEST_POINT	-	-	-
66	TP28,TP29,TP30,TP31	4	T POINT R	TEST_POINT	-	-	-
67	U1	1	BQ24232	BQ24232_16VQFN	BQ24232RGTT	TI	IC LI+ CHARGER PWR MGMT 16QFN
68	U2	1	FT2232HQ	FT2232HQ_64QFN	FT2232HQ	FTDI	IC USB HS DUAL UART/FIFO 64-QFN
69	U3	1	93LC56BT	93LC56BT_6SOT23	93LC56BT-I/OT	Microchip Technology	IC EEPROM 2KBIT 2MHZ SOT23-6

Item	Reference	Qty	Part	PCB Footprint	Part Number	Manufacturer	Description
70	U4	1	LCMXO2-2000ZE-1UWG49	XO2_2000ZE_49CSP	LCMXO2-2000ZE-1UWG49	Lattice	LCMXO2-2000ZE-1UWG49
71	U5	1	NOR Flash	N25Q032A_8SOIC	N25Q032A13ESC40G	Micron	IC FLASH 32MBIT 108MHZ 8SO
72	U6	1	MIC_LEFT	MP34DB01_RHLGA	MP34DB01TR	STMicroelectronics	MIC MEMS DIGITAL PDM OMNI -26DB
73	U7	1	MIC_RIGHT	MP34DB01_RHLGA	MP34DB01TR	STMicroelectronics	MIC MEMS DIGITAL PDM OMNI -26DB
74	U8	1	TPS61061	TPS61061_8QFN	TPS61061	TI	IC LED DRIVER WHITE BCKLGT 8SON
75	U9	1	iCE5LP4K	iCE5LP4K_SWG36	iCE5LP-4K-SWG36	Lattice	iCE40 Ultra family is an ultra-low power FPGA and sensor manager
76	U10	1	NOR-FLASH	M25P80_SO8N	M25P80-VMN6TP	Micron	IC FLASH 8MBIT 75MHZ 8SO
77	U11	1	4-BIT_TRANSLATOR	12DSBGA_TXB0104	TXB0104YZTR	Texas Instruments	IC XLATR VOLT-LVL 4B ESD 12DSBGA
78	U12	1	2-BIT_TRANSLATOR	8DSBGA_TXB0102	TXB0102YZPR	Texas Instruments	IC 2BIT V-TRANS-LATR W/ESD 8DSBGA
79	U13	1	MIC5320	MIC5320_6MLF	MIC5320-PGYMT TR	Micrel Inc	IC REG LDO 3V/1.8V 0.15A 6TMLF
80	U14	1	AOZ1281	AOZ1281_8DFN	AOZ1281DI	Würth Electronics	IC REG BUCK ADJ 1.8A 8DFN
81	U15	1	1-BIT_TRANSLATOR	6SON_SN74AUP1T34	SN74AUP1T34DSFR	Texas Instruments	IC V-LEVEL XLATR UNIDIR 6SON
82	U16	1	MIC5504	MIC5504_4TDFN	MIC5504-1.2YMT TZ	Micrel Inc	IC REG LDO 1.2V 0.3A 4TDFN
83	Y1	1	12 MHz	403C35D12M00000_4SMD	403C35D12M00000	Abrakon Corp	CRYSTAL 12MHZ 18PF SMD
84	Y2	1	27.000 MHz	OSC_ASCSM	ASCMSM-27.000MHZ-LR-T	Abrakon	OSC XO 27.000MHZ CMOS SMD



## Appendix D. Sensor Board Bill of Materials

Figure 22. Sensor Board Bill of Materials

Item	Reference	Qty	Part	PCB Footprint	Part Number	Manufacturer	Description
1	C1	1	10uF	C0805	C2012X5R1C106K085AC	TDK	CAP CER 10UF 16V 10% X5R 0805
2	C2,C3,C4,C6,C7,C9,C10,C12,C16,C17,C18,C19,C20	13	0.1uF	C0402	C1005X5R1C104K050BA	TDK	CAP CER 0.1UF 16V 10% X5R 0402
3	C5	1	0.01uF	C0402	GRM155R61C103KA01D	Murata	CAP CER 10000PF 16V 10% X5R 0402
4	C8	1	4.7uF	C0603	EMK107ABJ475KA-T	Taiyo Yuden	CAP CER 4.7UF 16V 10% X5R 0603
5	C11,C13	2	2.2uF	C0402	C1005X5R1C225K050BC	TDK	CAP CER 2.2UF 16V 10% X5R 0402
6	C14,C15	2	8pF	C0402	GRM1555C1E8R0CA01D	Murata	CAP CER 8PF 25V NP0 0402
7	C21	1	10uF	C0603	C1608X5R0J106K080AB	TDK	CAP CER 10UF 6.3V 10% X5R 0603
8	C22	1	22uF	C0603	C1608X5R0J226M080AC	TDK	CAP CER 22UF 6.3V 20% X5R 0603
9	J2	1	2X3 SOCKET	2X3_SOCKET406_SMD	406-43-206-30-068001	Mill-Max	CONN SOCKET 6POS .100 DBL SMD
10	J3	1	2X5 SOCKET	2X5_SOCKET406_SMD	406-43-210-30-068001	Mill-Max	CONN SOCKET 10POS .100 DBL SMD
11	J4	1	1X2 SOCKET	1X2_SOCKET310_SMD	310-43-102-41-105000	Mill-Max	CONN SOCKET STRIP 2PIN .100 SMD
12	J5	1	2X2 SOCKET	2X2_SOCKET406_SMD	406-43-204-30-068001	Mill-Max	CONN SOCKET 4POS .100 DBL SMD
13	L1	1	0.47uH	L2016	1286AS-H-R47M	Toko	Inductor 0.47uH DFE201612C series
14	R1,R12,R15,R25,R26,R27	6	10K	R0402	ERJ-2RKF1002X	Panasonic	RES 10K OHM 1/10W 1% 0402 SMD
15	R2,R3,R4,R5,R6,R7,R8,R9,R10,R11,R13,R14,R16,R17,R19,R21,R23	17	0	R0402	ERJ-2GE0R00X	Panasonic	RES 0.0 OHM 1/10W 0402 SMD
16	R18,R20	2	DNL	R0402	—	—	—
17	R22	1	0.001	R1206	CSNL1206FT1L00	Stackpole	RES SMD 0.001 OHM 1% 1W 1206
18	R24	1	1K	R0402	ERJ-2RKF1001X	Panasonic	RES 1K OHM 1/10W 1% 0402 SMD
19	TP1,TP2,TP3,TP4,TP5,TP6,TP7,TP8,TP9,TP10,TP11,TP14,TP15,TP16	14	TEST POINT	TEST_POINT	—	—	—
20	TP12,TP13	2	80_MIL_PAD	TP_80MIL	—	—	—
21	U1	1	FAN48610	FAN48610	FAN48610UC50X	Fairchild	IC REG BOOST SYNC 5V 1A 9WLCSP
22	U2	1	AFE4403	AFE4403_36DSBGA	AFE4403YZPT	TI	IC AFE FRONT END 36DSBGA
23	U3	1	LPS25H	LPS25H_10HCLGA	LPS25HTR	STMicroelectronics	IC MEMS PRESSURE SENSOR 10HCLGA
24	U4	1	LSM330DLC	LSM330DLC_28LGA	LSM330DLCTR	STMicroelectronics	ACCELEROMETER/ GYROSCOPE 28LGA
25	U5	1	SeeedBLE	SeeedBLE	113050012	Seeed	Low cost ARM cortex-m0 based module for Bluetooth module
26	U6	1	SFH7050	SFH7050	SFH7050	OSRAM	Biomonitoring Sensor for heart rate monitoring, Pulse oximetry and proximity
27	U7	1	TMP112	TMP112_SOT563	TMP112AIDRLT	TI	IC TEMP SENSOR DGTL 5V SOT563
28	Y1	1	8MHz	NX3225GD_8MHZ	NX3225GD-8MHZ-STD-CRA-3	NDK	CRYSTAL 8MHZ 8PF SMD

## Данный компонент на территории Российской Федерации

### Вы можете приобрести в компании MosChip.

Для оперативного оформления запроса Вам необходимо перейти по данной ссылке:

<http://moschip.ru/get-element>

Вы можете разместить у нас заказ для любого Вашего проекта, будь то серийное производство или разработка единичного прибора.

В нашем ассортименте представлены ведущие мировые производители активных и пассивных электронных компонентов.

Нашей специализацией является поставка электронной компонентной базы двойного назначения, продукции таких производителей как XILINX, Intel (ex.ALTERA), Vicor, Microchip, Texas Instruments, Analog Devices, Mini-Circuits, Amphenol, Glenair.

Сотрудничество с глобальными дистрибьюторами электронных компонентов, предоставляет возможность заказывать и получать с международных складов практически любой перечень компонентов в оптимальные для Вас сроки.

На всех этапах разработки и производства наши партнеры могут получить квалифицированную поддержку опытных инженеров.

Система менеджмента качества компании отвечает требованиям в соответствии с ГОСТ Р ИСО 9001, ГОСТ РВ 0015-002 и ЭС РД 009

### Офис по работе с юридическими лицами:

105318, г.Москва, ул.Щербаковская д.3, офис 1107, 1118, ДЦ «Щербаковский»

Телефон: +7 495 668-12-70 (многоканальный)

Факс: +7 495 668-12-70 (доб.304)

E-mail: [info@moschip.ru](mailto:info@moschip.ru)

Skype отдела продаж:

moschip.ru

moschip.ru\_4

moschip.ru\_6

moschip.ru\_9