



Features

- ◆ For industrial, office and residential applications
- ◆ Ultracompact plastic housing
- ◆ Connection by spring clamp terminals or detachable screw terminal block
- ◆ Reliable snap-on mounting on DIN-rails
- ◆ Adaptor for wall mounting
- ◆ Universal input 85–264 VAC, 50/60 Hz
- ◆ Models with 5, 12, 24 & 48 VDC output
- ◆ Output voltage adjustable
- ◆ Power OK signal
- ◆ Low ripple and noise
- ◆ Overload and short-circuit protection
- ◆ Parallel operation possible
- ◆ Worldwide safety approvals
- ◆ Redundancy module
- ◆ 3-year product warranty



The TRACOPOWER TCL series is a family of DIN-rail power supplies with an excellent price/performance ratio. With tightly regulated output voltage and high immunity against electrical disturbances on the mains they provide a reliable power source for sensitive loads in industrial process controls, machine tools and other equipment exposed to a difficult industrial environment. Compact size, light weight, easy snap-on mounting on DIN-rails and the choice of two connection terminal versions are other features of these power supplies. The TCL series complies with all major safety standards for Europe (EN60950-1, EN50178), North America (UL/cUL 60950, UL 508C listed) or elsewhere in the world (CB-Report).

Models

Order Code	Input Voltage Ranges	Output Power max.	*Output Voltage nom.	Output Current max.	Connection	
TCL 024-105	85 – 264 VAC Universal Input 50/60 Hz	24 W	5.1 VDC	4.0 A	Detachable screw terminal blocks	
TCL 024-112			12 VDC	2.0 A		
TCL 024-124			24 VDC	1.0 A		
TCL 060-112		85 – 375 VDC	60 W	12 VDC		4.0 A
TCL 060-124				24 VDC		2.5 A
TCL 060-148				48 VDC		1.25 A
TCL 120-112		85 – 375 VDC	120 W	12 VDC		8.0 A
TCL 120-124	24 VDC			5.0 A		
TCL 240-124	85-132/187-264 VAC	240 W	24 VDC	10.0 A		
TCL 024-124C	85 – 264 VAC Universal Input 50/60 Hz	24 W	24 VDC	1.0 A		
TCL 060-112C			60 W	12 VDC	4.0 A	
TCL 060-124C				24 VDC	2.5 A	
TCL 060-148C		48 VDC		1.25 A		
TCL 120-112C		85 – 375 VDC	120 W	12 VDC	8.0 A	
TCL 120-124C				24 VDC	5.0 A	

* adjustable

Input Specifications

Input voltage range		85–264 VAC/85–375 VDC
	TCL 240 model:	85–132/187–264 VAC autoselect (no DC input)
Output derating	– at operation between 85...93 VAC/85...130 VDC	15% for TCL 060 & TCL 120 20% for TCL 024-112 & TCL 024-124 & TCL 240 30% for TCL 024-105
Input frequency		47–63 Hz
Harmonic limits		EN 61000-3-2, Class A
Input current at full load (typ.) (115 VAC / 230 VAC)	TCL 024 models: TCL 060 models: TCL 120 models: TCL 240 model:	0.35 A / 0.2 A 1.2 A / 0.6 A 2.0 A / 1.0 A 3.3 A / 1.7 A
Recommended circuit breaker (characteristic C or slow blow fuse)		5.0 A

Output Specifications

Output voltage adjustable range (potentiometer on frontpanel)	5.1 VDC model: 12 VDC models: 24 VDC models: 48 VDC models:	5.0 – 5.25 VDC 12 – 15 VDC (12 - 16 VDC for TCL 024-112) 24 – 28 VDC 48 – 56 VDC
Output regulation (10 to 90% load variation)		2.5 % (1 % for TCL 60-112)
Ripple and noise (20MHz bandwidth)		<50 mV pk-pk
Electronic short circuit protection		current limitation at 120 % typ. (constant current, automatic recovery TCL 24 models: foldback, automatic recovery)
Parallel operation		output current characteristic suitable for parallel operation of max. 5 units (not for TCL 240-124)
Overvoltage protection, trigger point	5.1 VDC model: 12/24 VDC models: 48 VDC models:	<6.5 VDC <40 VDC <60 VDC
Hold-up time (115 VAC / 230 VAC)		min. 15 ms / min. 125 ms
Power OK signal (TCL 60 & TCL 120 only)	trigger point 12 VDC models: 24 VDC models: 48 VDC models:	output signal (reference to – Vout) 11.0 V ±1.0 V / 60 mA max. 22.0 V ±2.0 V / 30 mA max. 44.0 V ±4.0 V / 15 mA max.

General Specifications

Temperature ranges	– Operating – Storage (non operating)	–10°C to +70°C max. –25°C to +85°C
Temperature derating	– at 187...264 VAC or 265...375 VDC operation – at 93...132 VAC or 130...187 VDC operation – at 85...130 VDC operation	1.7 %/K above 50°C 1.1 %/K above 40°C 1.3 %/K above 30°C
Humidity (non condensing)		95 % rel. H max.
Temperature coefficient		0.02 %/K
Switching frequency		55 – 180 kHz depending on load (frequency modulation)
Efficiency		88 % typ.

General Specifications

Reliability, calculated MTBF at +25°C (according to IEC-1709)	TCL 024 models: >2.68 Mio h TCL 060 models: >2.94 Mio h TCL 120 models: >1.62 Mio h (TCL 240 tbd.)
Safety standards	<ul style="list-style-type: none"> - Information technology equipment - Industrial control equipment - Electronic equipment for power installation - Electrical equipment for machines - Safety transformers for SMPS - Limited power source
Safety approvals	<ul style="list-style-type: none"> - CB test certificate (IEC 60950-1) - UL approval - UL approval - CSA certification - BG certificate (by SIQ)
Environmental compliance	<ul style="list-style-type: none"> - Reach - RoHS
Electromagnetic compatibility (EMC), emissions	
Electromagnetic compatibility (EMC), immunity	
Safety class	
Case protection	
Enclosure material	
Mounting	
Options	
Installation instructions	

All specifications valid at nominal input voltage, full load and +25°C after warm-up time unless otherwise stated.

TCL-REM240 Redundancy Module

This module enables redundant operation of any two TCL models by decoupling the 2 power supplies. It can also be used to separate sensitive loads from the main power source.



Order Code	Nominal Input Voltage	Input Voltage Range	Max Power per Input	Output Voltage	Output Current max.
TCL-REM240	5...48 VDC	5...60 VDC	200 W	$V_{in} - 0.9$ VDC	8 A

Specifications

Operating temperature	-10°C to +70°C max. (14°F ... +158°F) derating above +40°C (104°F): 1.5 %/K
Electromagnetic compatibility	in correspondence to connected units (no internal switching device)
Dimensions	same as model TCL 024 (see page 4)
Connection	detachable screw terminal block
Installation instructions	www.tracopower.com/products/tcl-rem-inst.pdf

Case Dimensions

TCL 024 and TCL-REM240 models

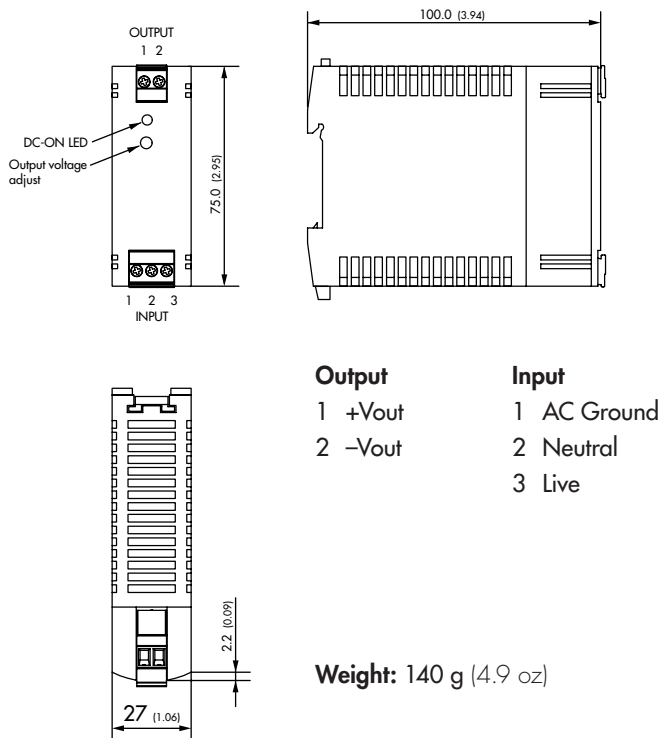

Dimensions in [mm], () = Inch
Tolerances: ±0.5 mm (±0.02)

Case Dimensions

TCL 60 models

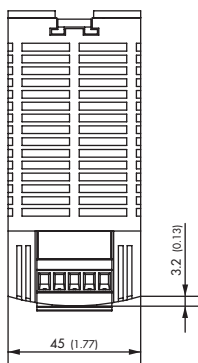
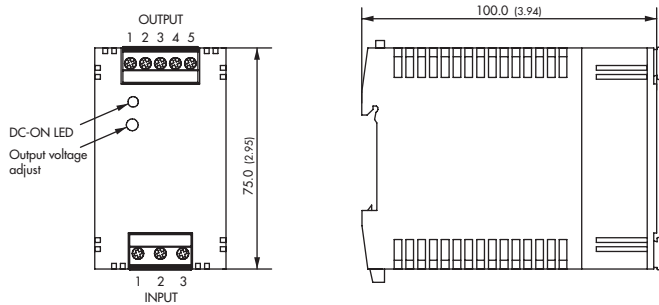

Output

- 1 +Vout
- 2 +Vout
- 3 -Vout
- 4 -Vout
- 5 Power OK

Input

- 1 AC Ground
- 2 Neutral
- 3 Live

Weight: 265 g (9.4 oz)

TCL 120 models

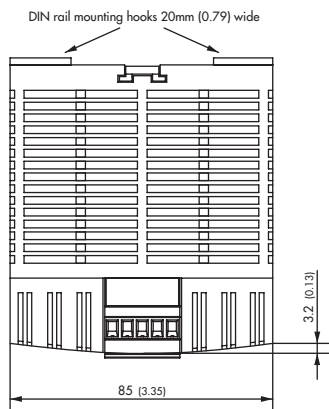
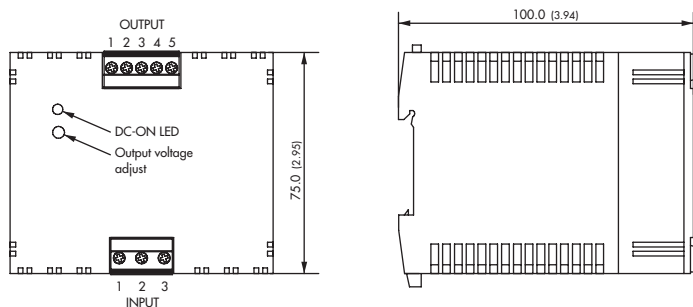

Output

- 1 +Vout
- 2 +Vout
- 3 -Vout
- 4 -Vout
- 5 Power OK

Input

- 1 AC Ground
- 2 Neutral
- 3 Live

Weight: 440 g (15.5 oz)

Dimensions in [mm], () = Inch
Tolerances: ± 0.5 mm (± 0.02)

Case Dimensions

TCL 240 model

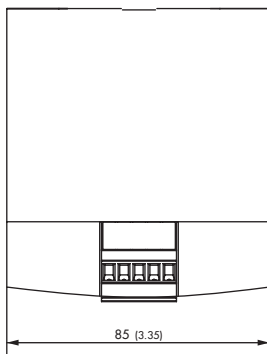
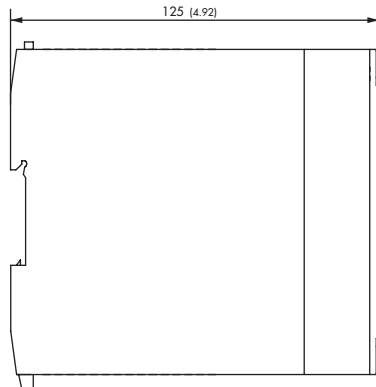
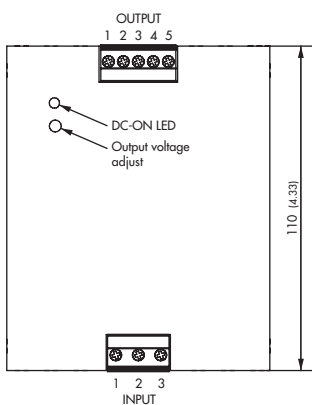

Output	Input
1 +Vout	1 AC Ground
2 +Vout	2 Neutral
3 -Vout	3 Live
4 -Vout	
5 Power OK	

Weight: 950 g (33.5 oz)

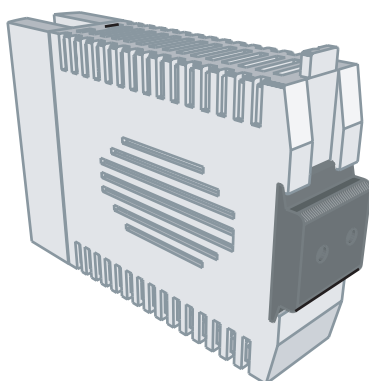

Wall Mounting Bracket

Instead on a DIN-rail, the modules can be also mounted on a chassis or wall with help of a mounting bracket which is supplied as standard with each power supply

Dimensions in [mm], () = Inch
Tolerances: ± 0.5 mm (± 0.02)

Данный компонент на территории Российской Федерации

Вы можете приобрести в компании MosChip.

Для оперативного оформления запроса Вам необходимо перейти по данной ссылке:

<http://moschip.ru/get-element>

Вы можете разместить у нас заказ для любого Вашего проекта, будь то серийное производство или разработка единичного прибора.

В нашем ассортименте представлены ведущие мировые производители активных и пассивных электронных компонентов.

Нашей специализацией является поставка электронной компонентной базы двойного назначения, продукции таких производителей как XILINX, Intel (ex.ALTERA), Vicor, Microchip, Texas Instruments, Analog Devices, Mini-Circuits, Amphenol, Glenair.

Сотрудничество с глобальными дистрибьюторами электронных компонентов, предоставляет возможность заказывать и получать с международных складов практически любой перечень компонентов в оптимальные для Вас сроки.

На всех этапах разработки и производства наши партнеры могут получить квалифицированную поддержку опытных инженеров.

Система менеджмента качества компании отвечает требованиям в соответствии с ГОСТ Р ИСО 9001, ГОСТ РВ 0015-002 и ЭС РД 009

Офис по работе с юридическими лицами:

105318, г.Москва, ул.Щербаковская д.3, офис 1107, 1118, ДЦ «Щербаковский»

Телефон: +7 495 668-12-70 (многоканальный)

Факс: +7 495 668-12-70 (доб.304)

E-mail: info@moschip.ru

Skype отдела продаж:

moschip.ru

moschip.ru_4

moschip.ru_6

moschip.ru_9