

HLMP-CBxx, HLMP-CMxx T-1³/₄ (5 mm) InGaN Blue and Green LEDs

Description

These high-intensity blue and green LEDs are based on the most efficient and cost-effective InGaN material technology.

These LED lamps are untinted and non-diffused T-1³/₄ packages incorporating second generation optics producing well-defined spatial radiation patterns at specific viewing cone angles.

These lamps are made with an advanced optical grade epoxy offering superior high temperature and high moisture resistance performance in outdoor signal and sign applications. The epoxy contains UV inhibitors to reduce the effects of long term exposure to direct sunlight.

Features

- Viewing angle: 15°, 23°, and 30°
- Well-defined spatial radiation pattern
- High luminous output
- Available in blue and green
 - Blue 470 nm
 - Green 525 nm
- Superior resistance to moisture
- Standoff and non-standoff package

Applications

- Traffic signs
- Variable message signs
- Commercial outdoor advertising

CAUTION! InGaN devices are Class 1C HBM ESD sensitive per JEDEC Standard. Please observe appropriate precautions during handling and processing. Refer to Application Note AN-1142 for additional details.

Figure 1: Package Dimensions

Drawing A (Non-standoff)

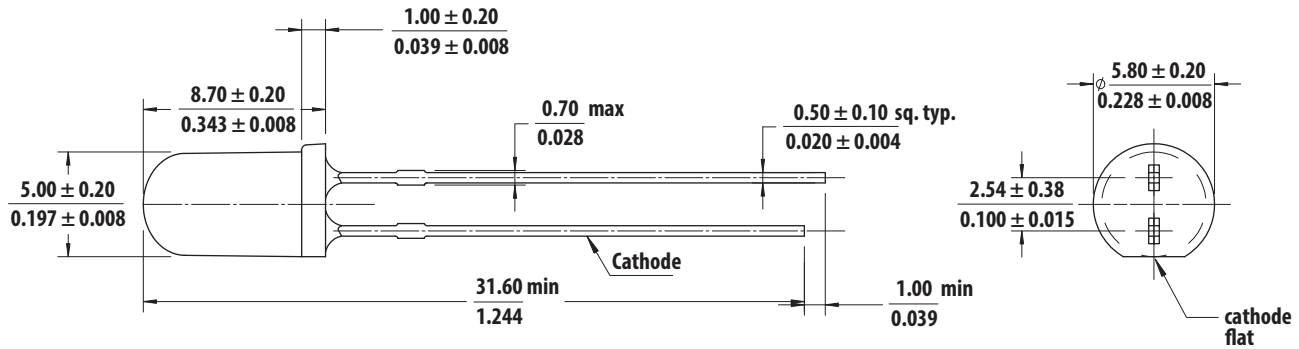

Drawing B (Standoff)

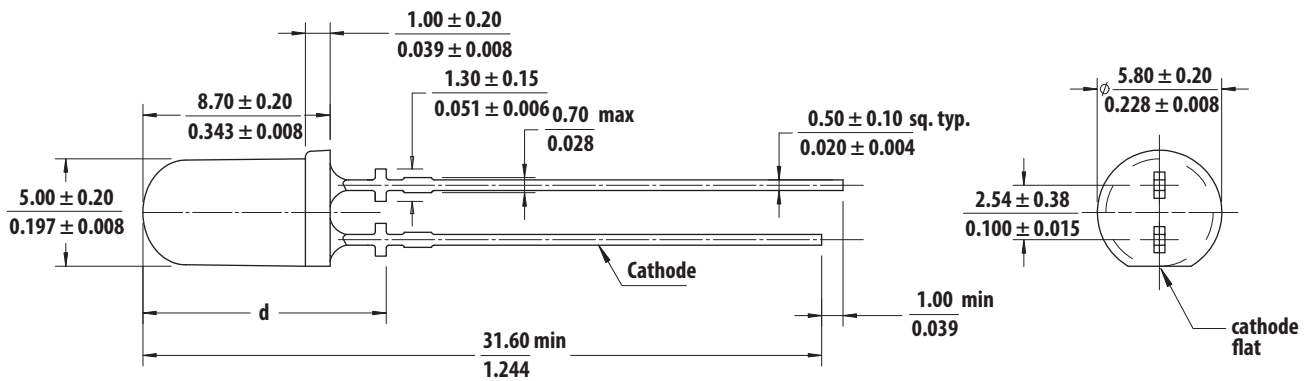

| Part Number | Dimension 'd' |
|-------------|------------------------|
| HLMP-Cx1H | 12.39 mm \pm 0.25 mm |
| HLMP-Cx2H | 12.35 mm \pm 0.25 mm |
| HLMP-Cx3H | 11.93 mm \pm 0.25 mm |

NOTE:

1. All dimensions in millimeters (inches).
2. Tolerance is ± 0.20 mm unless other specified.
3. Leads are mild steel with tin plating.
4. The epoxy meniscus is 1.5 mm maximum.

Device Selection Guide

| Part Number | Color and Dominant Wavelength λ_d (nm) Typ. ^a [3] | Luminous Intensity I_v (mcd) at 20 mA ^{b, c, d} | | Standoff | Typical Viewing Angle (°) ^e |
|-----------------|---|--|-------|----------|--|
| | | Min | Max | | |
| HLMP-CB1G-XZ0DD | Blue 470 | 7200 | 16000 | No | 15 |
| HLMP-CB1H-XZ0DD | Blue 470 | 7200 | 16000 | Yes | |
| HLMP-CM1G-350DD | Green 525 | 27000 | 59000 | No | |
| HLMP-CM1H-350DD | Green 525 | 27000 | 59000 | Yes | 23 |
| HLMP-CB2G-UW0DD | Blue 470 | 3200 | 7200 | No | |
| HLMP-CB2H-UW0DD | Blue 470 | 3200 | 7200 | Yes | |
| HLMP-CM2G-130DD | Green 525 | 16000 | 35000 | No | |
| HLMP-CM2H-130DD | Green 525 | 16000 | 35000 | Yes | 30 |
| HLMP-CB3G-TV0DD | Blue 470 | 2500 | 5500 | No | |
| HLMP-CB3H-TV0DD | Blue 470 | 2500 | 5500 | Yes | |
| HLMP-CM3G-Y10DD | Green 525 | 9300 | 21000 | No | |
| HLMP-CM3H-Y10DD | Green 525 | 9300 | 21000 | Yes | |

- Dominant wavelength, λ_d , is derived from the CIE Chromaticity Diagram and represents the color of the lamp.
- The luminous intensity is measured on the mechanical axis of the lamp package and it is tested with pulsing condition.
- The optical axis is closely aligned with the package mechanical axis.
- Tolerance for each bin limit is $\pm 15\%$.
- $\theta_{1/2}$ is the off-axis angle where the luminous intensity is half the on-axis intensity.

Absolute Maximum Ratings

$T_J = 25^\circ\text{C}$

| Parameter | Blue/Green | Unit |
|-----------------------------------|-------------|------|
| DC Forward Current ^a | 30 | mA |
| Peak Forward Current ^b | 100 | mA |
| Power Dissipation | 110 | mW |
| LED Junction Temperature | 110 | °C |
| Operating Temperature Range | -40 to +85 | °C |
| Storage Temperature Range | -40 to +100 | °C |

- Derate linearly as shown in [Figure 5](#).
- Duty factor 10%, frequency 1 kHz.

Electrical/Optical Characteristics

$T_J = 25^\circ\text{C}$

| Parameter | Symbol | Min. | Typ. | Max. | Units | Test Conditions |
|---|-------------------|------------|--------------|------------|----------------------|--|
| Forward Voltage Blue and Green | V_F | 2.8 | 3.1 | 3.6 | V | $I_F = 20\text{ mA}$ |
| Reverse Voltage ^a Blue and Green | V_R | 5 | — | — | V | $I_R = 10\text{ }\mu\text{A}$ |
| Dominant Wavelength ^b Blue Green | λ_d | 460 520 | 470 525 | 480 540 | nm | $I_F = 20\text{ mA}$ |
| Peak Wavelength Blue Green | λ_{PEAK} | — — | 461 517 | — — | nm | Peak of Wavelength of Spectral Distribution at $I_F = 20\text{ mA}$ |
| Thermal resistance | $R\theta_{J-PIN}$ | — | 240 | — | $^\circ\text{C/W}$ | LED junction to pin |
| Luminous Efficacy ^c Blue Green | η_V | — — | 68 475 | — — | lm/W | Emitted Luminous Power/Emitted Radiant Power |
| Thermal coefficient of λ_d Blue Green | | — — | 0.02 0.03 | — — | nm/ $^\circ\text{C}$ | $I_F = 20\text{ mA}; +25^\circ\text{ C} \leq T_J \leq +100^\circ\text{ C}$ |

- Indicates product final testing condition, long-term reverse bias is not recommended.
- The dominant wavelength is derived from the Chromaticity Diagram and represents the color of the lamp.
- The radiant intensity, I_e in watts per steradian, maybe found from the equation $I_e = I_v / \eta_V$ where I_v is the luminous intensity in candelas and η_V is the luminous efficacy in lumens/ watt.

Part Numbering System

H L M P -

| | | | |
|----------------|----------------|----------------|----------------|
| x ₁ | x ₂ | x ₃ | x ₄ |
|----------------|----------------|----------------|----------------|

 -

| | | | | |
|----------------|----------------|----------------|----------------|----------------|
| x ₅ | x ₆ | x ₇ | x ₈ | x ₉ |
|----------------|----------------|----------------|----------------|----------------|

| Code | Description | Option | |
|-------------------------------|----------------------------------|--------|--|
| x ₁ | Package type | C | 5-mm Standard Round InGaN |
| x ₂ | Color | B | Blue |
| | | M | Green |
| x ₃ x ₄ | Viewing Angle and Lead Standoffs | 1G | 15° without lead standoffs |
| | | 1H | 15° with lead standoffs |
| | | 2G | 23° without lead standoffs |
| | | 2H | 23° with lead standoffs |
| | | 3G | 30° without lead standoffs |
| | | 3H | 30° with lead standoffs |
| x ₅ | Minimum intensity bin | | See Device Selection Guide |
| x ₆ | Maximum intensity bin | | See Device Selection Guide |
| x ₇ | Color bin selection | 0 | Full range |
| x ₈ x ₉ | Packaging option | DD | Ammopack |

Bin Information

Intensity Bin Limit Table (1.3:1 Iv Bin Ratio)

| Bin | Intensity (mcd) at 20 mA | |
|-----|--------------------------|-------|
| | Min | Max |
| T | 2500 | 3200 |
| U | 3200 | 4200 |
| V | 4200 | 5500 |
| W | 5500 | 7200 |
| X | 7200 | 9300 |
| Y | 9300 | 12000 |
| Z | 12000 | 16000 |
| 1 | 16000 | 21000 |
| 2 | 21000 | 27000 |
| 3 | 27000 | 35000 |
| 4 | 35000 | 45000 |
| 5 | 45000 | 59000 |

Tolerance for each bin limit is ± 15%.

Green Color Bin Table

| Bin | Min Dom | Max Dom | Xmin | Ymin | Xmax | Ymax |
|-----|---------|---------|--------|--------|--------|--------|
| 1 | 520.0 | 524.0 | 0.0743 | 0.8338 | 0.1856 | 0.6556 |
| | | | 0.1650 | 0.6586 | 0.1060 | 0.8292 |
| 2 | 524.0 | 528.0 | 0.1060 | 0.8292 | 0.2068 | 0.6463 |
| | | | 0.1856 | 0.6556 | 0.1387 | 0.8148 |
| 3 | 528.0 | 532.0 | 0.1387 | 0.8148 | 0.2273 | 0.6344 |
| | | | 0.2068 | 0.6463 | 0.1702 | 0.7965 |
| 4 | 532.0 | 536.0 | 0.1702 | 0.7965 | 0.2469 | 0.6213 |
| | | | 0.2273 | 0.6344 | 0.2003 | 0.7764 |
| 5 | 536.0 | 540.0 | 0.2003 | 0.7764 | 0.2659 | 0.6070 |
| | | | 0.2469 | 0.6213 | 0.2296 | 0.7543 |

Tolerance for each bin limit is ± 0.5 nm.

Blue Color Bin Table

| Bin | Min Dom | Max Dom | Xmin | Ymin | Xmax | Ymax |
|-----|---------|---------|--------|--------|--------|--------|
| 1 | 460.0 | 464.0 | 0.1440 | 0.0297 | 0.1766 | 0.0966 |
| | | | 0.1818 | 0.0904 | 0.1374 | 0.0374 |
| 2 | 464.0 | 468.0 | 0.1374 | 0.0374 | 0.1699 | 0.1062 |
| | | | 0.1766 | 0.0966 | 0.1291 | 0.0495 |
| 3 | 468.0 | 472.0 | 0.1291 | 0.0495 | 0.1616 | 0.1209 |
| | | | 0.1699 | 0.1062 | 0.1187 | 0.0671 |
| 4 | 472.0 | 476.0 | 0.1187 | 0.0671 | 0.1517 | 0.1423 |
| | | | 0.1616 | 0.1209 | 0.1063 | 0.0945 |
| 5 | 476.0 | 480.0 | 0.1063 | 0.0945 | 0.1397 | 0.1728 |
| | | | 0.1517 | 0.1423 | 0.0913 | 0.1327 |

Tolerance for each bin limit is ± 0.5 nm.

NOTE: All bin categories are established for classification of products. Products may not be available in all bin categories. Contact your Broadcom® representative for further information.

Broadcom Color Bin on CIE 1931 Chromaticity Diagram

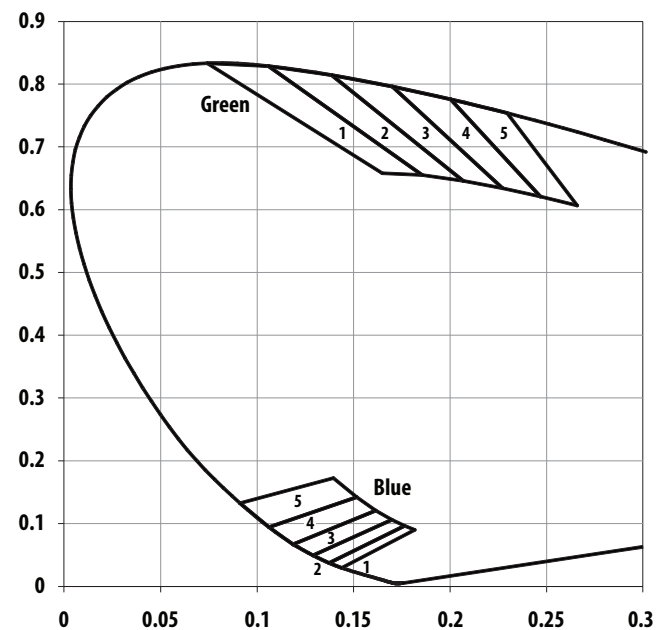

Figure 2: Relative Intensity vs. Wavelength

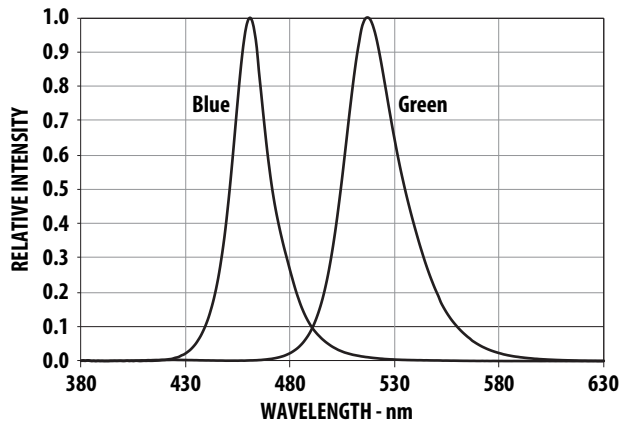

Figure 3: Forward Current vs. Forward Voltage

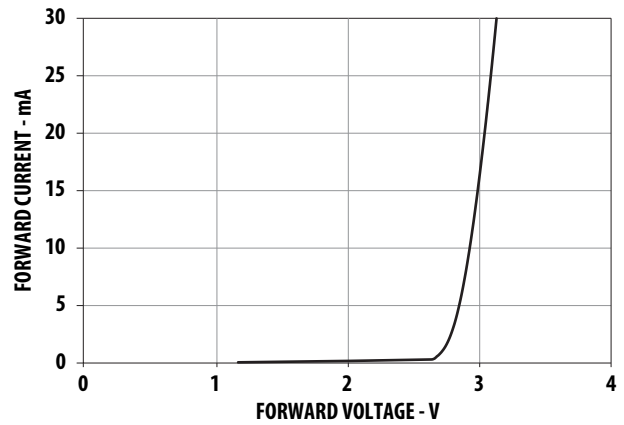

Figure 4: Relative Intensity vs. Forward Current

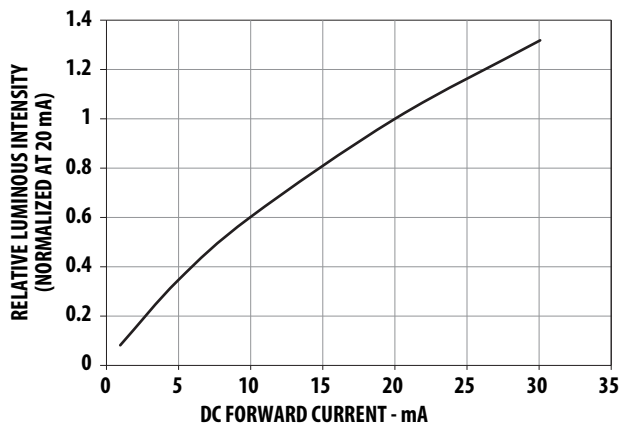

Figure 5: Maximum Forward Current vs. Ambient Temperature

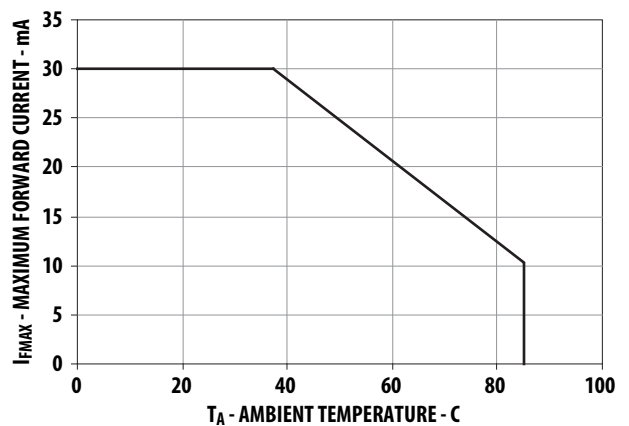

Figure 6: Relative Dominant Wavelength Shift vs. Forward Current

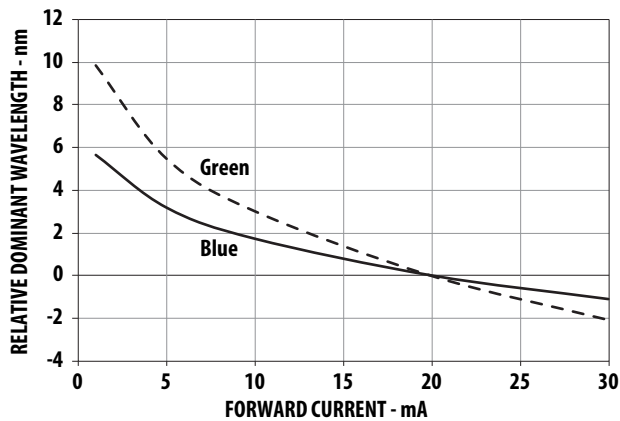

Figure 7: Representative Radiation Pattern for 15° Viewing Angle Lamp

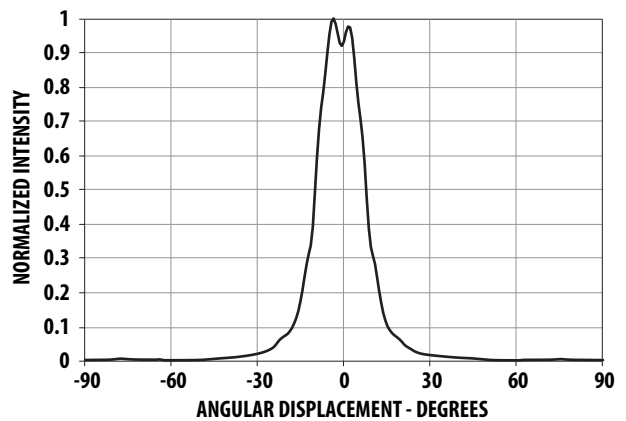

Figure 8: Representative Radiation Pattern for 23° Viewing Angle Lamp

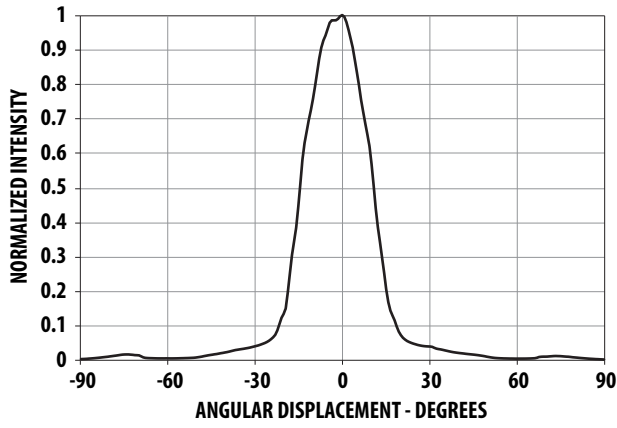

Figure 9: Representative Radiation Pattern for 30° Viewing Angle Lamp

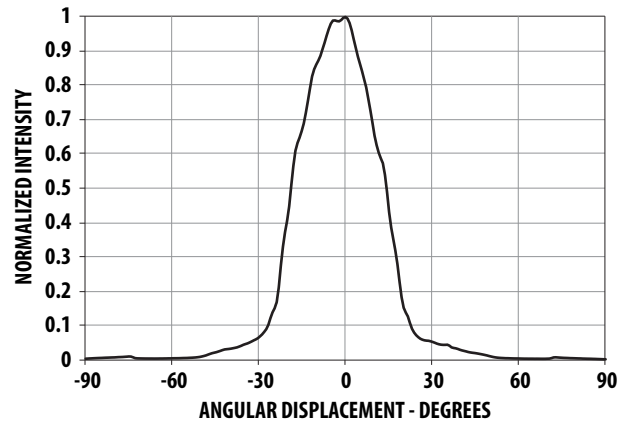

Figure 10: Relative Light Output vs. Junction Temperature

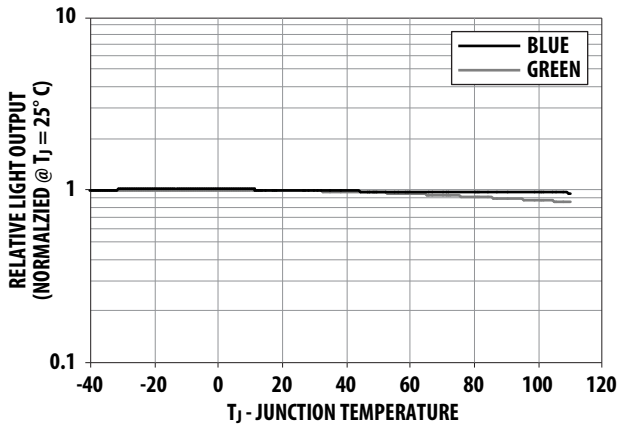
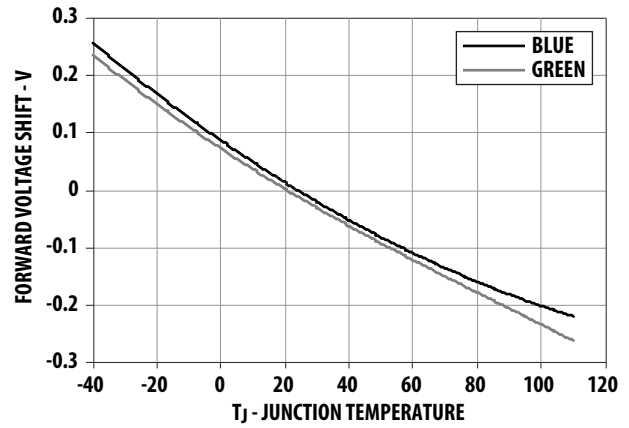

Figure 11: Forward Voltage Shift vs. Junction Temperature



Precautions

Lead Forming

- The leads of an LED lamp may be preformed or cut to length prior to insertion and soldering on PC board.
- For better control, use the proper tool to precisely form and cut the leads to applicable length rather than doing it manually.
- If manual lead cutting is necessary, cut the leads after the soldering process. The solder connection forms a mechanical ground that prevents mechanical stress due to lead cutting from traveling into LED package. Use this method for hand soldering operations, as the excess lead length also acts as a small heat sink.

Soldering and Handling

- Take care during PCB assembly and soldering process to prevent damage to the LED component.
- The LED component may be effectively hand-soldered to PCB; however, do this only under unavoidable circumstances, such as rework. The closest manual soldering distance of the soldering heat source (soldering iron's tip) to the body is 1.59 mm. Soldering the LED using soldering iron tip closer than 1.59 mm might damage the LED.



- Apply ESD precautions on the soldering station and personnel to prevent ESD damage to the LED component, which is ESD sensitive. Refer to Broadcom application note AN-1142 for details. The soldering iron used must have a grounded tip to ensure electrostatic charge is properly grounded.
- Recommended soldering condition:

| | Wave Soldering ^{a, b} | Manual Solder Dipping |
|----------------------|--------------------------------|-----------------------|
| Pre-heat temperature | 105°C max. | — |
| Preheat time | 60s max. | — |
| Peak temperature | 260°C max. | 260°C max. |
| Dwell time | 5s max. | 5s max. |

a. The above conditions refer to measurement with a thermocouple mounted at the bottom of the PCB.
 b. Use only bottom preheaters to reduce thermal stress experienced by the LED.

- Set and maintain wave soldering parameters according to the recommended temperature and dwell time. Perform a daily check on the soldering profile to ensure that it is always conforming to recommended soldering conditions.

NOTE: PCBs with different sizes and design (component density) have different heat masses (heat capacities). This might cause a change in temperature experienced by the board if the same wave soldering setting is used. Recalibrate the soldering profile again before loading a new type of PCB.

Broadcom LED Configuration

Figure 12: LED Configuration

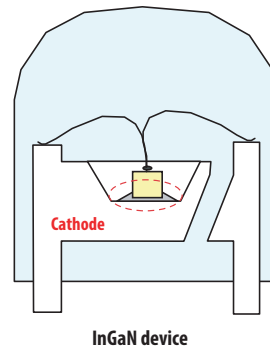

- Any alignment fixture that is applied during wave soldering must be loosely fitted and must not apply weight or force on LED. Use nonmetal material because it absorbs less heat during the wave soldering process.
- At elevated temperatures, the LED is more susceptible to mechanical stress. Therefore, allow the PCB to cool down to room temperature prior to handling, which includes removal of alignment fixture or pallet.
- If PCB board contains both through hole (TH) LED and other surface-mount components, solder the surface-mount components on the top side of the PCB. If surface mount must be on the bottom side, solder these components using reflow soldering prior to the insertion of the TH LED.

- The recommended PC board plated through holes (PTH) size for LED component leads follows.

| LED Component Lead Size | Diagonal | Plated Through-Hole Diameter |
|--|--------------------------|--|
| 0.45 × 0.45 mm (0.018 in. × 0.018 in.) | 0.636 mm (0.025 inch) | 0.98 mm to 1.08 mm (0.039 in. to 0.043 in.) |
| 0.50 mm × 0.50 mm (0.020 in. × 0.020 in.) | 0.707 mm (0.028 inch) | 1.05 mm to 1.15 mm (0.041 in. to 0.045 in.) |

- Over-sizing the PTH can lead to a twisted LED after clinching. However, undersizing the PTH can cause difficulty inserting the TH LED.

Refer to application note AN-5334 for more information about soldering and handling of high brightness TH LED lamps.

Figure 13: Example of Wave Soldering Temperature Profile for TH LED

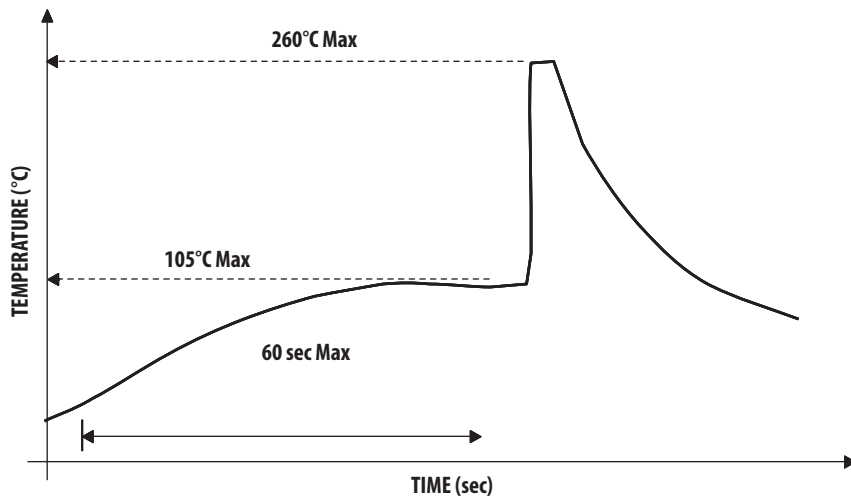

Recommended solder:
 Sn63 (Leaded solder alloy)
 SAC305 (Lead free solder alloy)

Flux: Rosin flux

Solder bath temperature: 255°C ± 5°C
 (maximum peak temperature = 260°C)

Dwell time: 3.0 sec - 5.0 sec
 (maximum = 5sec)

Note: Allow for board to be sufficiently cooled to room temperature before exerting mechanical force.

Figure 14: Ammo Packs Drawing

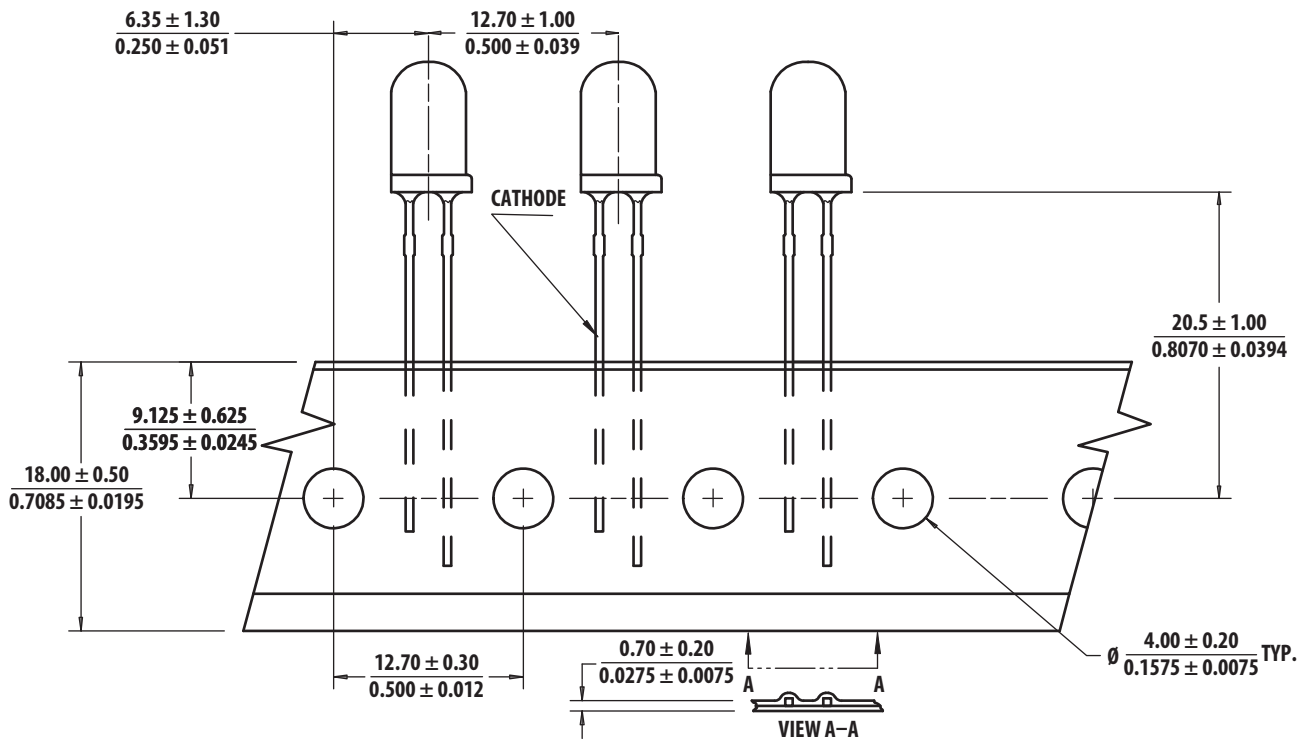

NOTE: The ammo-packs drawing is applicable for packaging option -DD and -ZZ and regardless standoff or non-standoff.

Figure 15: Packaging Box for Ammo Packs

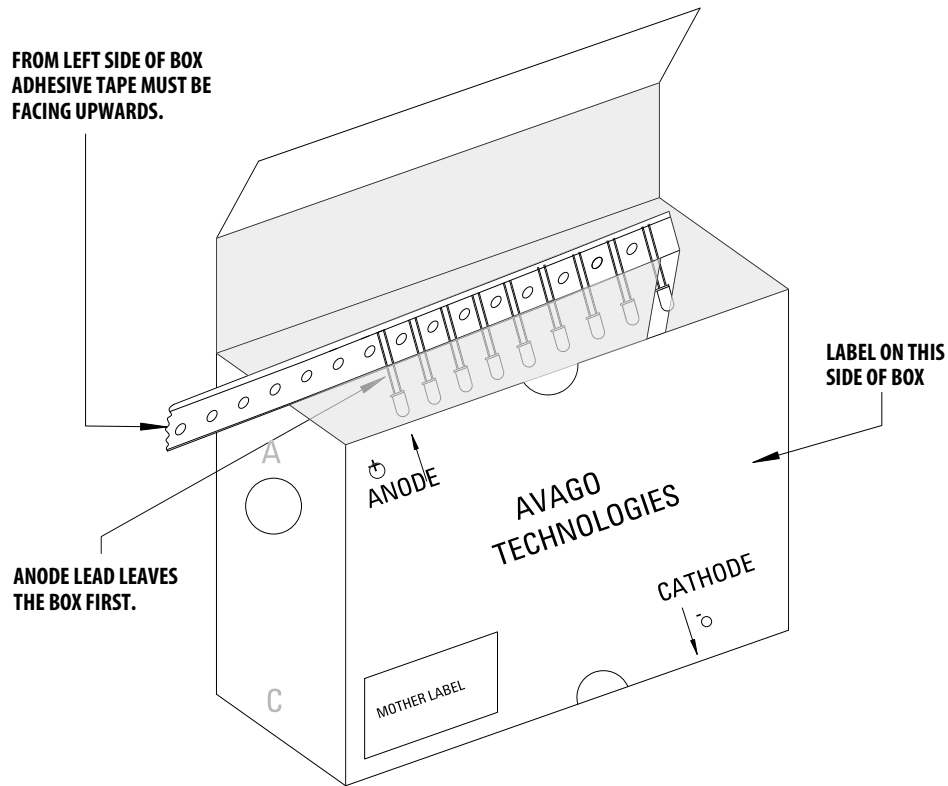

NOTE: For InGaN devices, the ammo pack packaging box contains an ESD logo.

Packaging Label

Figure 16: Mother Label (Available on packaging box of ammo pack and shipping box)

| | |
|---|---|
| AVAGO TECHNOLOGIES | |
| (1P) Item: Part Number | STANDARD LABEL LS0002 RoHS Compliant e3 max temp 260C |
| (1T) Lot: Lot Number | (Q) QTY: Quantity |
| LPN: | CAT: Intensity Bin |
| (9D)MFG Date: Manufacturing Date | BIN: Color Bin |
| <hr/> | |
| (P) Customer Item: | |
| (V) Vendor ID: | (9D) Date Code: Date Code |
| <hr/> | |
| DeptID: | Made In: Country of Origin |

Figure 17: Baby Label (Only available on bulk packaging)

| | |
|---|---------------------------------------|
| AVAGO TECHNOLOGIES | |
| Lamps Baby Label | |
| (1P) PART #: Part Number | RoHS Compliant e3 max temp 260C |
| (1T) LOT #: Lot Number | |
| (9D)MFG DATE: Manufacturing Date | QUANTITY: Packing Quantity |
| C/O: Country of Origin | |
| <hr/> | |
| Customer P/N: | CAT: Intensity Bin |
| Supplier Code: | BIN: Color Bin |
| | DATECODE: Date Code |

Disclaimer

Broadcom's products and software are not specifically designed, manufactured, or authorized for sale as parts, components, or assemblies for the planning, construction, maintenance, or direct operation of a nuclear facility or for use in medical devices or applications. The customer is solely responsible, and waives all rights to make claims against Broadcom or its suppliers, for all loss, damage, expense, or liability in connection with such use.

Broadcom, the pulse logo, Connecting everything, Avago Technologies, Avago, and the A logo are among the trademarks of Broadcom and/or its affiliates in the United States, certain other countries, and/or the EU.

Copyright © 2014–2018 Broadcom. All Rights Reserved.

The term "Broadcom" refers to Broadcom Limited and/or its subsidiaries. For more information, please visit www.broadcom.com.

Broadcom reserves the right to make changes without further notice to any products or data herein to improve reliability, function, or design. Information furnished by Broadcom is believed to be accurate and reliable. However, Broadcom does not assume any liability arising out of the application or use of this information, nor the application or use of any product or circuit described herein, neither does it convey any license under its patent rights nor the rights of others.



Данный компонент на территории Российской Федерации

Вы можете приобрести в компании MosChip.

Для оперативного оформления запроса Вам необходимо перейти по данной ссылке:

<http://moschip.ru/get-element>

Вы можете разместить у нас заказ для любого Вашего проекта, будь то серийное производство или разработка единичного прибора.

В нашем ассортименте представлены ведущие мировые производители активных и пассивных электронных компонентов.

Нашей специализацией является поставка электронной компонентной базы двойного назначения, продукции таких производителей как XILINX, Intel (ex.ALTERA), Vicor, Microchip, Texas Instruments, Analog Devices, Mini-Circuits, Amphenol, Glenair.

Сотрудничество с глобальными дистрибьюторами электронных компонентов, предоставляет возможность заказывать и получать с международных складов практически любой перечень компонентов в оптимальные для Вас сроки.

На всех этапах разработки и производства наши партнеры могут получить квалифицированную поддержку опытных инженеров.

Система менеджмента качества компании отвечает требованиям в соответствии с ГОСТ Р ИСО 9001, ГОСТ РВ 0015-002 и ЭС РД 009

Офис по работе с юридическими лицами:

105318, г.Москва, ул.Щербаковская д.3, офис 1107, 1118, ДЦ «Щербаковский»

Телефон: +7 495 668-12-70 (многоканальный)

Факс: +7 495 668-12-70 (доб.304)

E-mail: info@moschip.ru

Skype отдела продаж:

moschip.ru

moschip.ru_4

moschip.ru_6

moschip.ru_9