

Applications

- Electronic Warfare
- Radar
- Communications
- Test Instrumentation
- EMC Amplifier



Product Features

- Frequency Range: 2 – 6 GHz
- Pout: 45 dBm at $P_{IN} = 23$ dBm
- PAE: >30% CW
- Small Signal Gain: >26 dB
- IM3: -30 dBc @ 30 dBm Pout/Tone
- Bias: $V_D = 28$ V, $I_{DQ} = 400$ mA, $V_G = -2.8$ V Typical
- Package Dimensions: 15.2 x 15.2 x 3.5 mm
- Package base is pure Cu offering superior thermal management

Functional Block Diagram

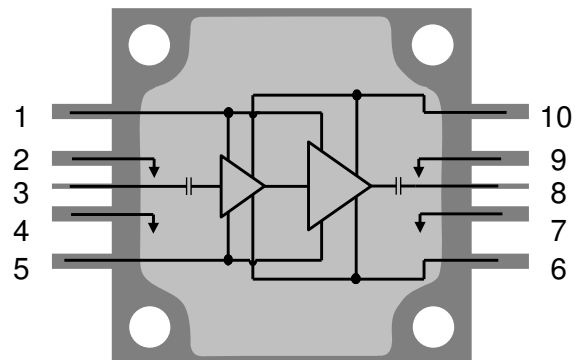

General Description

Qorvo's TGA2578-CP is a packaged wideband power amplifier fabricated on Qorvo's TQGaN25 0.25um GaN on SiC process. Operating from 2 to 6 GHz, the TGA2578-CP achieves 30 W saturated output power with a power-added efficiency of > 30 %, and > 26 dB small signal gain.

The TGA2578-CP is offered in a 10-lead 15 x 15 mm bolt-down package. The package has a pure Cu base, offering superior thermal management. The TGA2578-CP is ideally suited to support both commercial and defense applications.

Both RF ports have integrated DC blocking capacitors and are fully matched to 50 Ohms.

Lead free and RoHS compliant.

Evaluation Boards are available upon request.

Pin Configuration

Pad No.	Symbol
1, 5	V_G
2, 4, 7, 9	GND
3	RF_{IN}
6, 10	V_D
8	RF_{OUT}

Ordering Information

Part	ECCN	Description
TGA2578-CP	3A001.b.2.a	2 – 6 GHz, 30 W GaN Power Amplifier

Absolute Maximum Ratings

Parameter	Value
Drain Voltage (V _D)	40 V
Gate Voltage Range (V _G)	-8 to 0 V
Drain Current (I _D)	5 A
Reverse Gate Current (I _G)	-15 mA
Forward Gate Current (I _G)	See graph this page
Power Dissipation (P _{DISS}), 85 °C	85 W
Input Power, CW, 50 Ω, (P _{IN})	27 dBm
Input Power, CW, VSWR 3:1, V _D = 30 V, 85 °C, (P _{IN})	27 dBm
Input Power, CW, VSWR 10:1, V _D = 28 V, 85 °C (P _{IN})	25 dBm
Channel Temperature (T _{CH})	275 °C
Mounting Temperature (30 Seconds)	260 °C
Storage Temperature	-55 to 150 °C

Operation of this device outside the parameter ranges given above may cause permanent damage. These are stress ratings only, and functional operation of the device at these conditions is not implied.

Recommended Operating Conditions

Parameter	Value
Drain Voltage (V _D)	28 V
Drain Current (I _{DQ})	400 mA
Drain Current Under RF Drive (I _{D_DRIVE})	See plots p. 7
Gate Voltage (V _G)	-2.8 V (Typ.)
Gate Current Under RF Drive (I _{G_DRIVE})	See plots p. 7
Temperature (T _{BASE})	-40 to 85 °C

Electrical specifications are measured at specified test conditions. Specifications are not guaranteed over all recommended operating conditions.

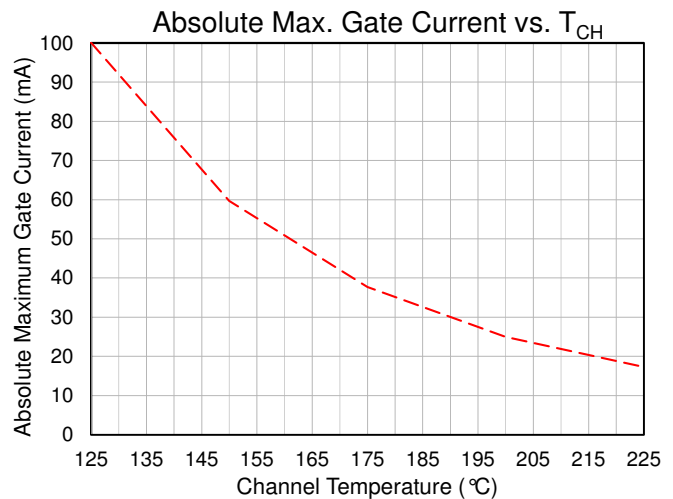

Electrical Specifications

Test conditions unless otherwise noted: 25 °C, V_D = 28 V, I_{DQ} = 400 mA, V_G = -2.8 V Typ, CW.

Parameter	Min	Typical	Max	Units
Operational Frequency Range	2.0		6.0	GHz
Small Signal Gain		> 26		dB
Input Return Loss		> 12		dB
Output Return Loss		> 5		dB
Output Power @ Pin = 23 dBm		45		dBm
Power Added Efficiency @ Pin = 23 dBm		> 30		%
IM3 (Pout/tone = 30 dBm/Tone)		-30		dBc
IM5 (Pout/tone = 30 dBm/Tone)		-40		dBc
Small Signal Gain Temperature Coefficient		-0.05		dB/°C
Output Power Temperature Coefficient		-0.02		dBm/°C

Thermal and Reliability Information

Parameter	Test Conditions	Value	Units
Thermal Resistance (θ_{JC}) ⁽¹⁾	$T_{BASE} = 85^\circ\text{C}$, $V_D = 28\text{ V}$ (CW)	1.95	$^\circ\text{C/W}$
Channel Temperature (T_{CH}) (Under RF drive)	At Freq = 5 GHz, $P_{IN} = 23\text{ dBm}$: $I_{DQ} = 400\text{ mA}$, $I_{D_Drive} = 3.0\text{ A}$	192	$^\circ\text{C}$
Median Lifetime (T_M)	$P_{OUT} = 44\text{ dBm}$, $P_{DISS} = 55\text{ W}$	2.6E+7	Hrs

Notes:

1. Thermal resistance measured to back of package.

Test Conditions: $V_D = 40\text{ V}$; Failure Criteria = 10% reduction in I_{D_MAX}

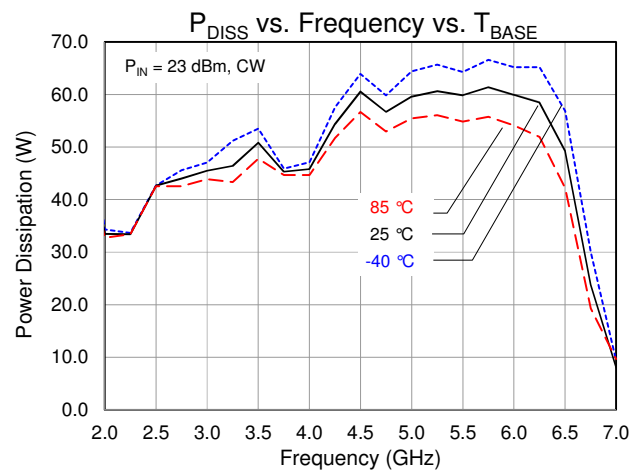
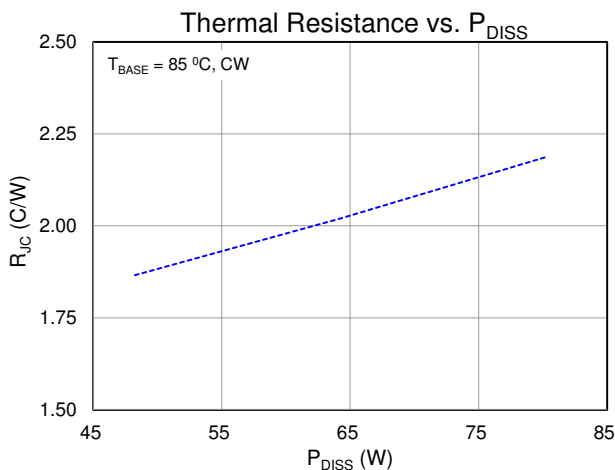
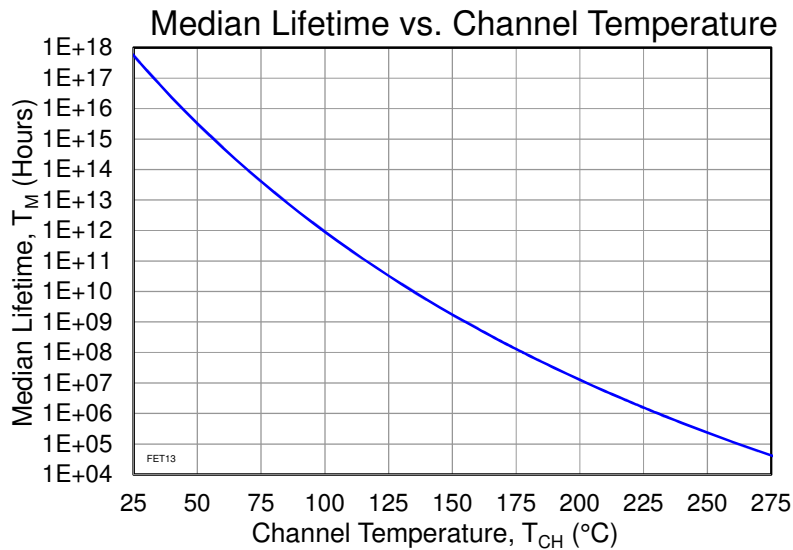

Typical Performance: Small Signal

Conditions unless otherwise specified: $V_D = 28\text{ V}$, $I_{DQ} = 400\text{ mA}$, $V_G = -2.8\text{ V}$ Typical, CW.

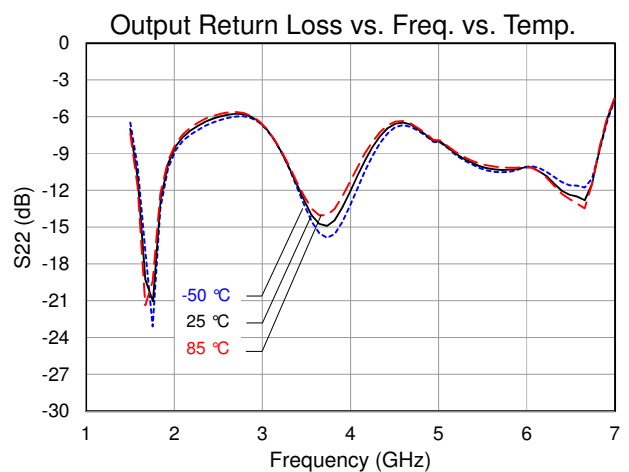
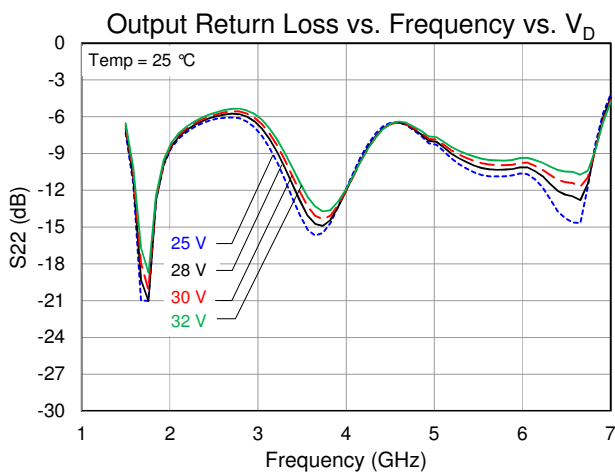
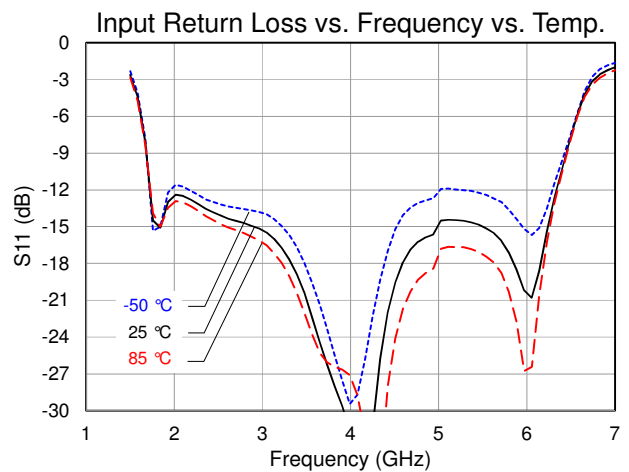
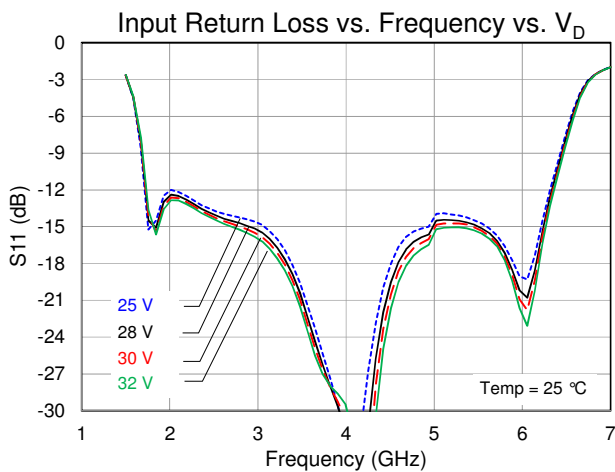
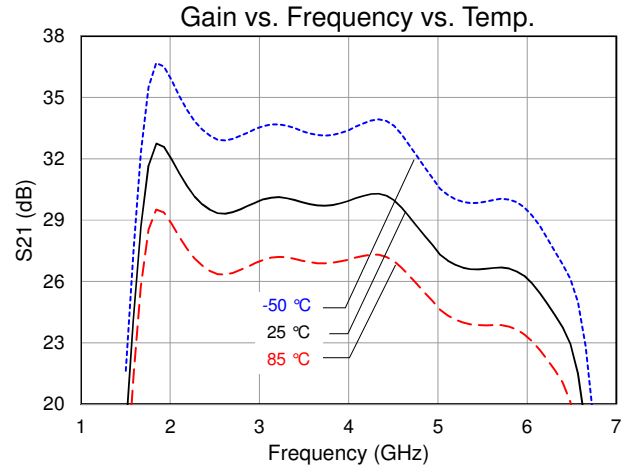
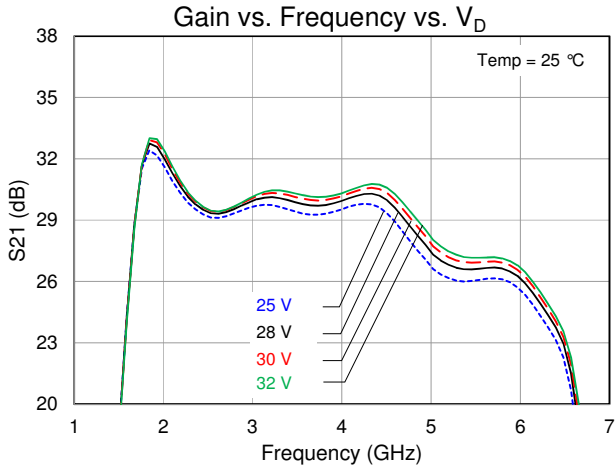

Typical Performance: Large Signal

Conditions unless otherwise specified: $V_D = 28\text{ V}$, $I_{DQ} = 400\text{ mA}$, $V_G = -2.8\text{ V}$ Typical, CW.

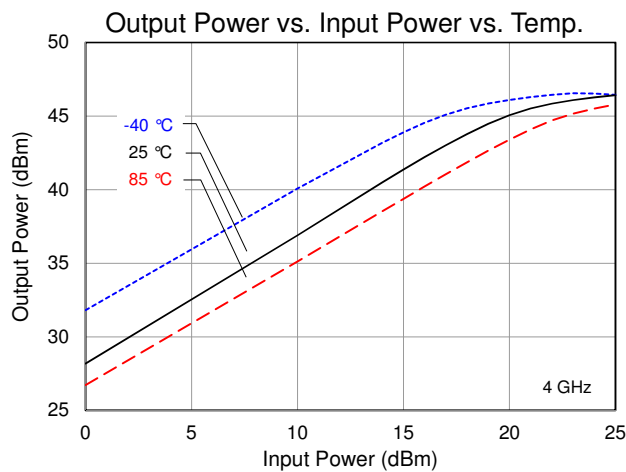
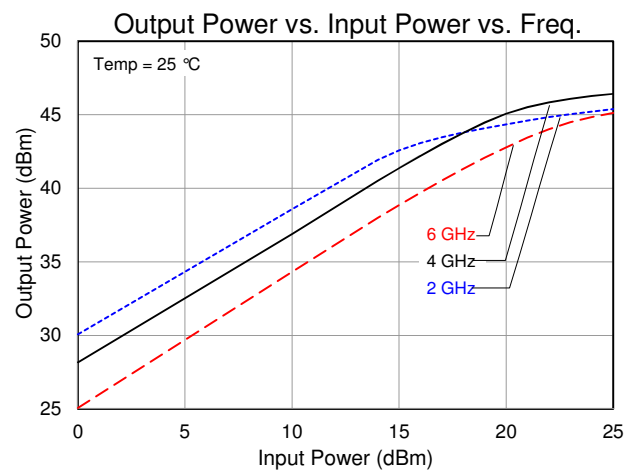
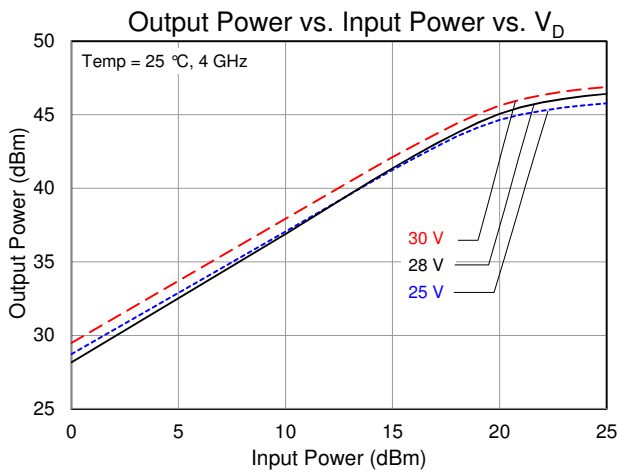
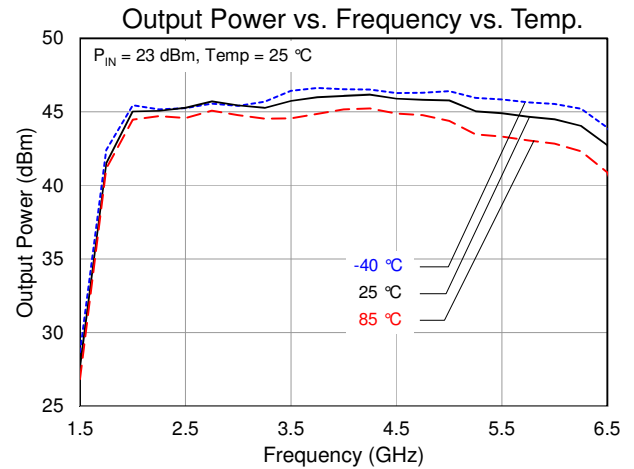
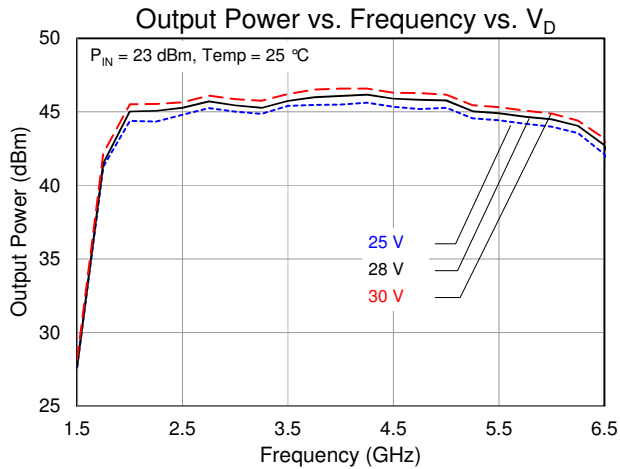

Typical Performance: Large Signal

Conditions unless otherwise specified: $V_D = 28\text{ V}$, $I_{DQ} = 400\text{ mA}$, $V_G = -2.8\text{ V}$ Typical, CW.

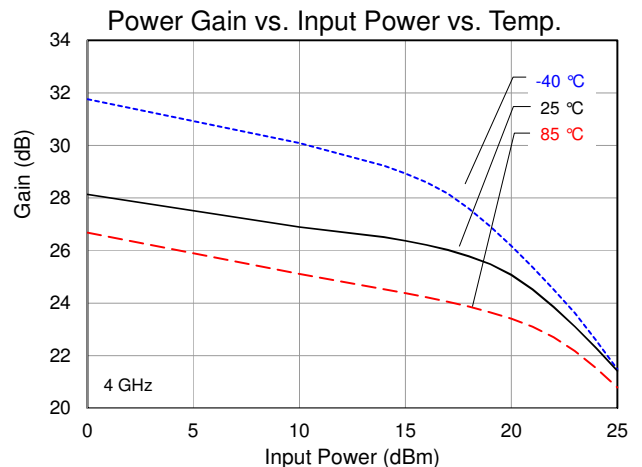
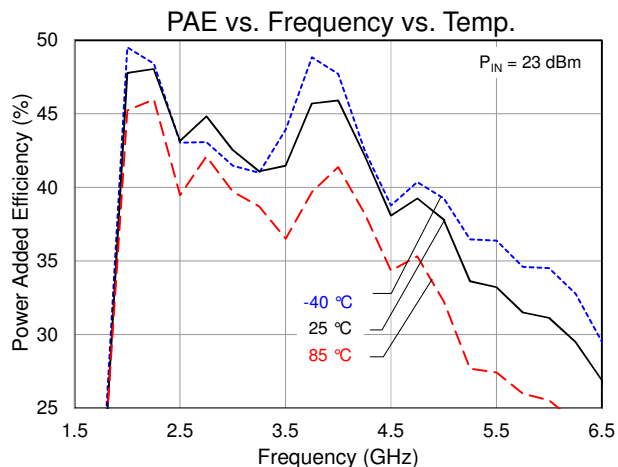
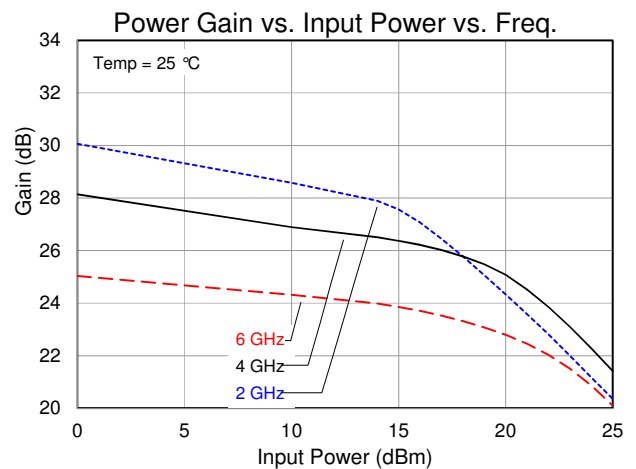
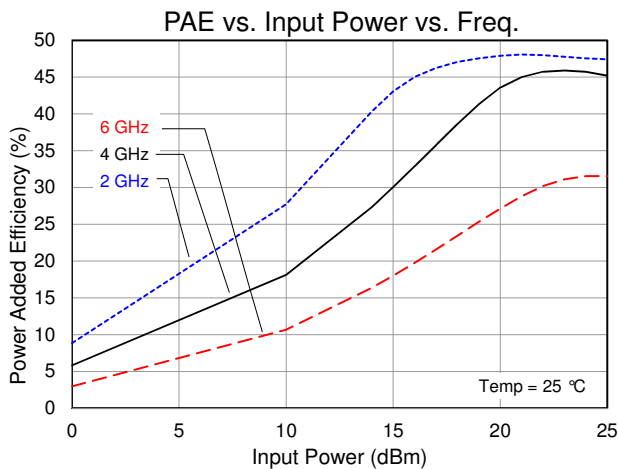
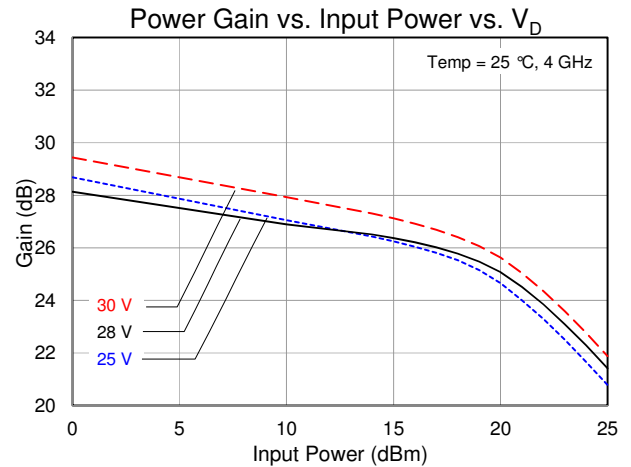
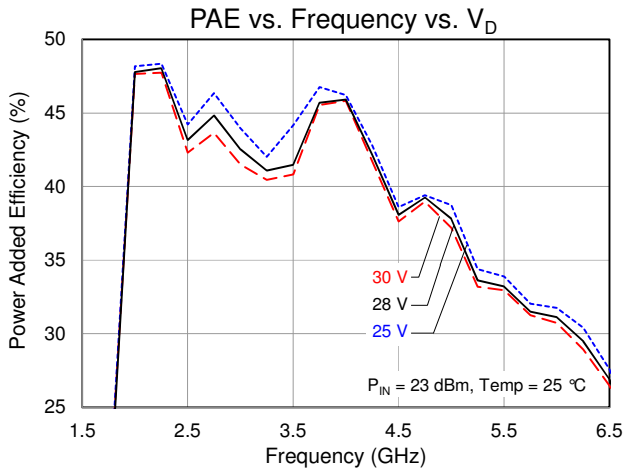

Typical Performance: Large Signal

Conditions unless otherwise specified: $V_D = 28\text{ V}$, $I_{DQ} = 400\text{ mA}$, $V_G = -2.8\text{ V}$ Typical, CW.

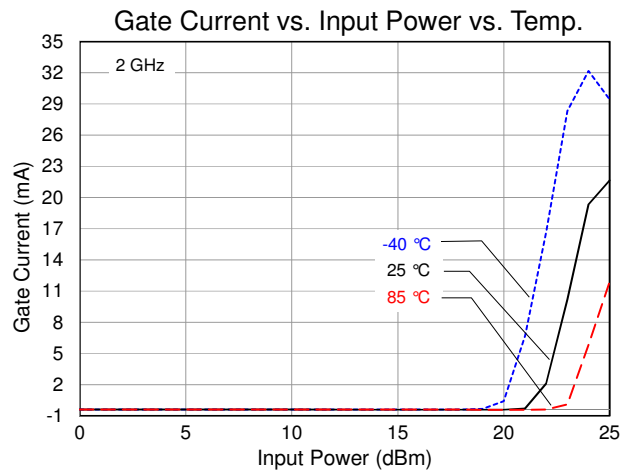
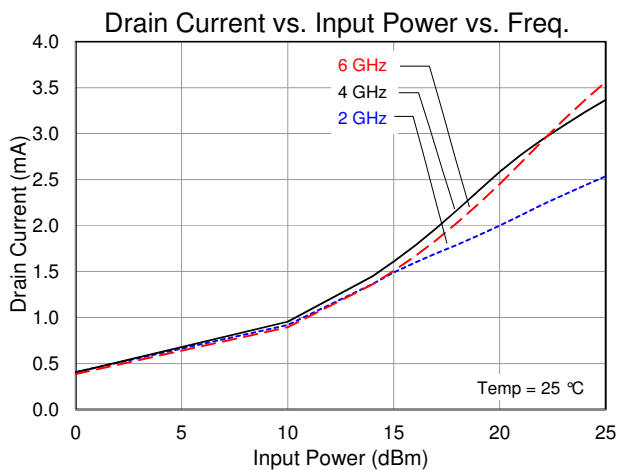
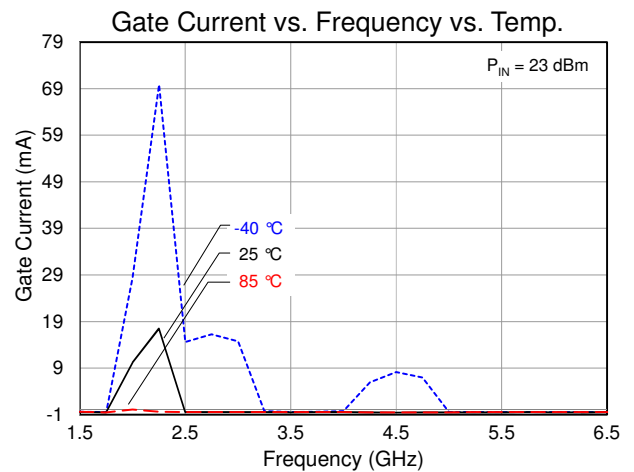
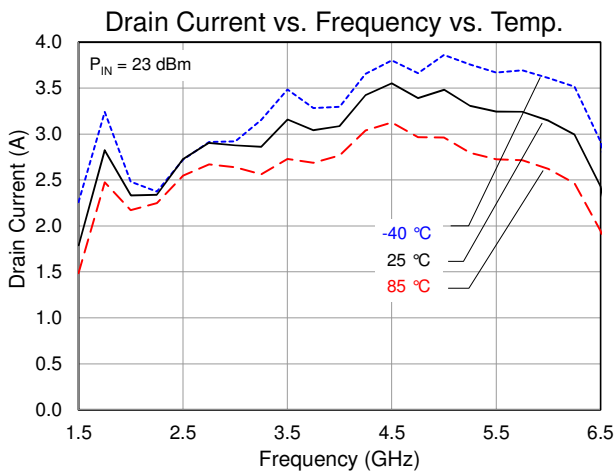
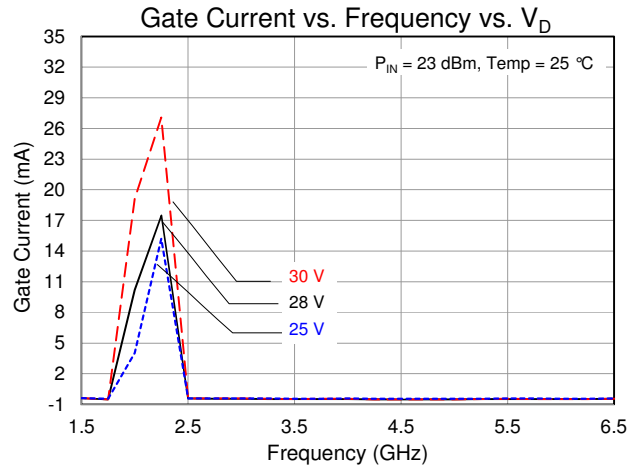
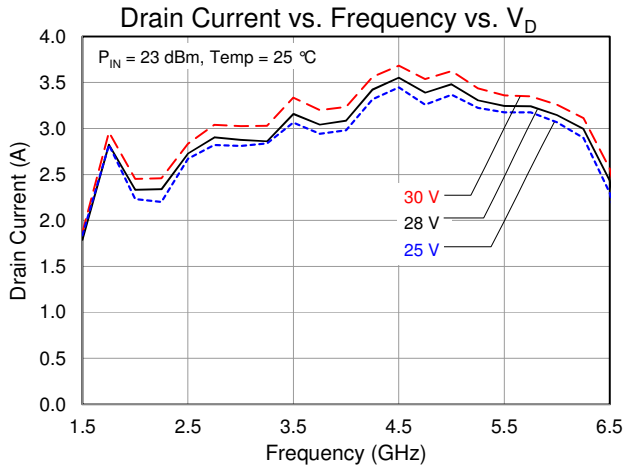

Typical Performance: Large Signal and Linearity

Conditions unless otherwise specified: $V_D = 28\text{ V}$, $I_{DQ} = 400\text{ mA}$, $V_G = -2.8\text{ V}$ Typical, CW.

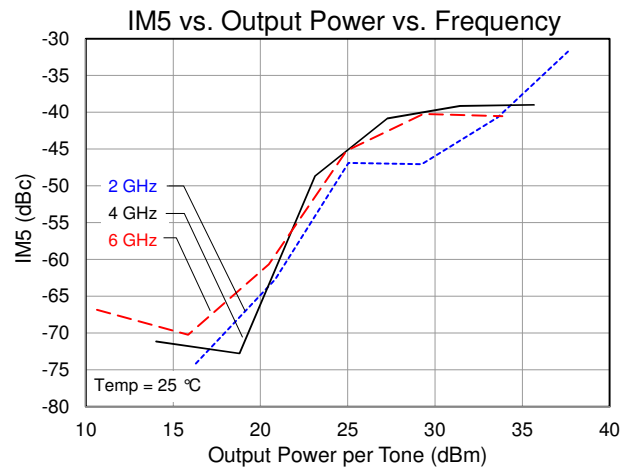
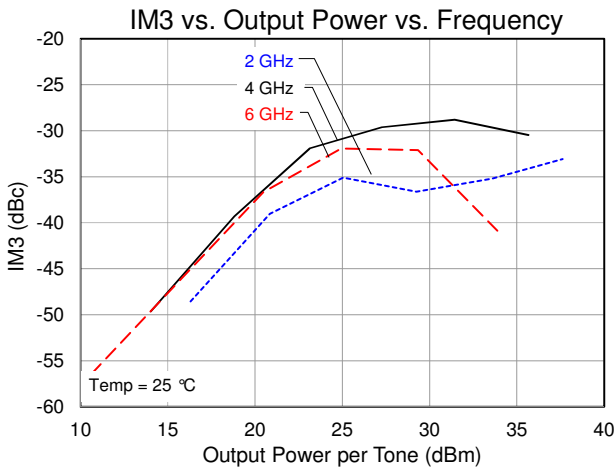
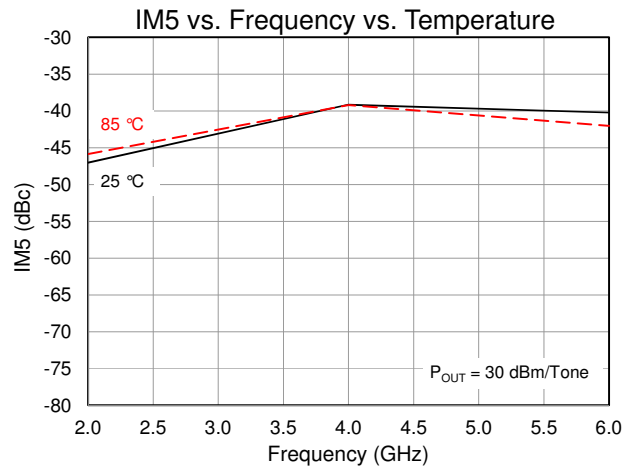
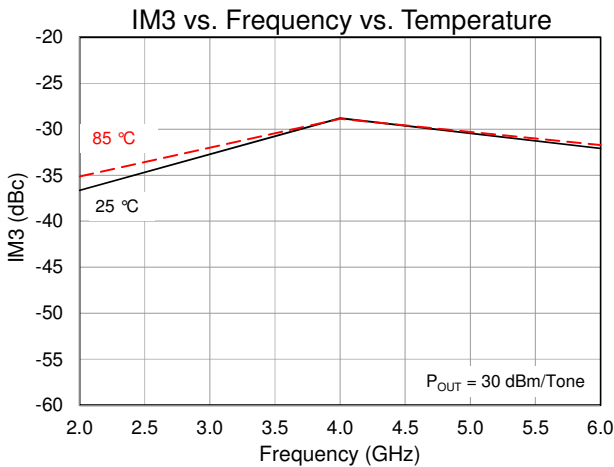
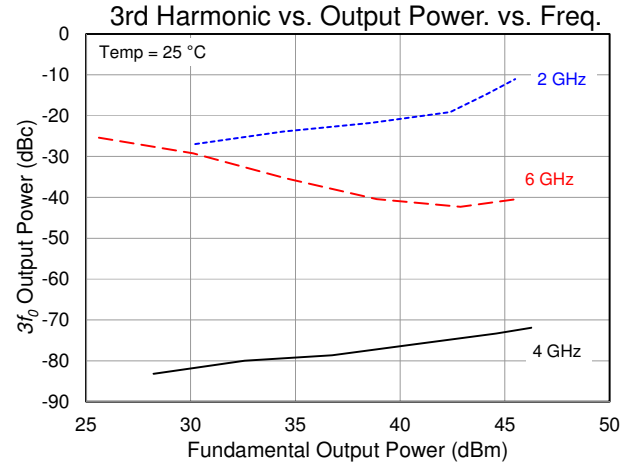
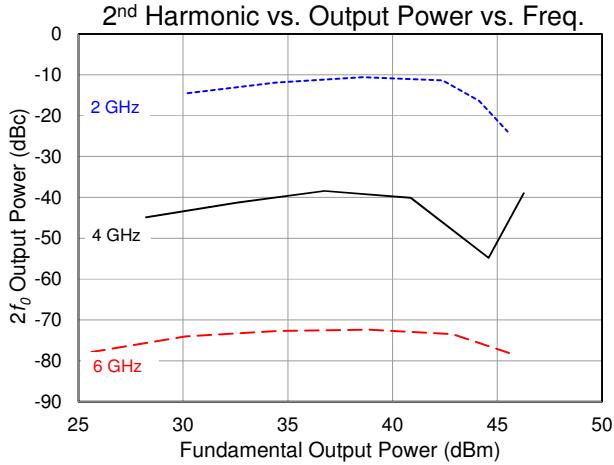

Applications Information and Pin Layout

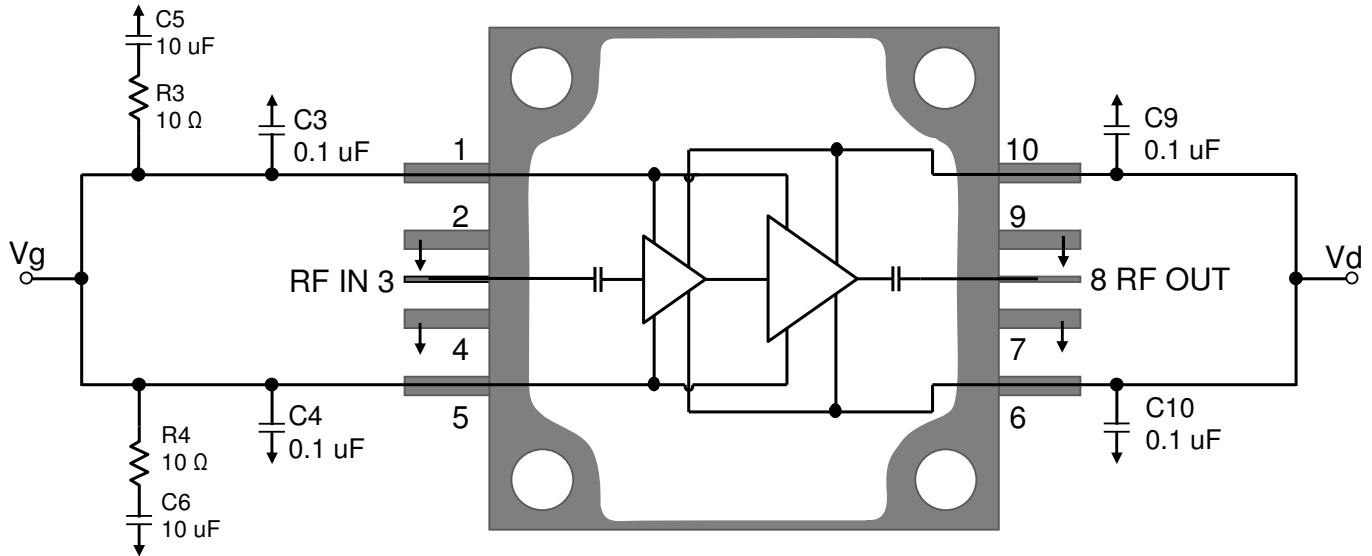

Bias-up Procedure

1. Set I_D limit to 5 A, I_G limit to 25 mA
2. Apply -5 V to V_G
3. Apply +28 V to V_D ; ensure I_{DQ} is approx. 0 mA
4. Adjust V_G until $I_{DQ} = 400$ mA ($V_G \sim -2.8$ V Typ.).
5. Turn on RF supply

Bias-down Procedure

1. Turn off RF supply
2. Reduce V_G to -5 V; ensure I_{DQ} is approx. 0 mA
3. Set V_D to 0 V
4. Turn off V_D supply
5. Turn off V_G supply

Pin Description

Pin No.	Symbol	Description
1,5	V_G	Gate Voltage; Bias network is required; must be biased from both sides; see recommended Application Information above.
3	RF_{IN}	Output; matched to 50 Ω ; DC blocked
2,4,7,9	GND	Must be grounded on the PCB.
6,10	V_D	Drain voltage; Bias network is required; must be biased from both sides; see recommended Application Information above.
8	RF_{OUT}	Input; matched to 50 Ω ; DC blocked

Evaluation Board

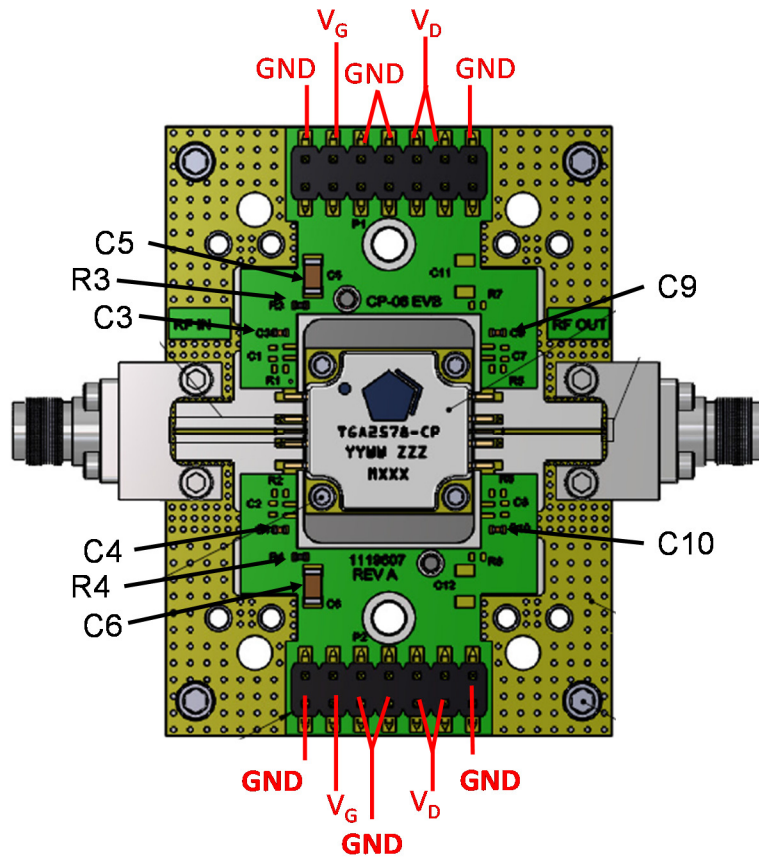

NOTE: Both Top and Bottom Vd and Vg must be biased.

Bill of Material

Reference Des.	Value	Description	Manuf.	Part Number
C3, C4, C9, C10	0.1 μ F	Cap, 0402, 50 V, 10%, X7R	Various	
C5, C6	10 μ F	Cap, 1206, 50 V, 20%, X5R	Various	
R3, R4	10 Ohm	Res, 0402, 5%	Various	

Assembly Notes

1. Clean the board or module with alcohol. Allow it to dry fully.
2. Nylock screws are recommended for mounting the TGA2578-CP to the board.
3. To improve the thermal and RF performance, we recommend the following:
 - a. Apply thermal compound or 4 mils indium shim between the package and the board.
 - b. Attach a heat sink to the bottom of the board and apply thermal compound or 4 mils indium shim between the heat sink and the board.
4. Apply solder to each pin of the TGA2578-CP.
5. Clean the assembly with alcohol.

Mechanical Information

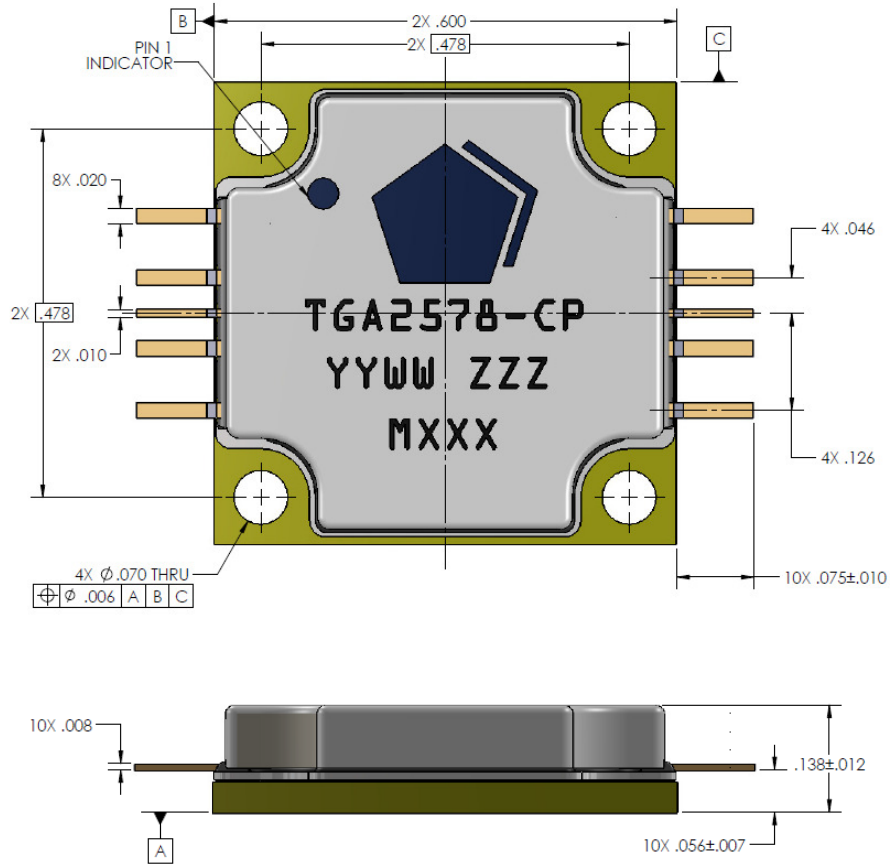

Units: inches

Tolerances: unless specified

x.xx = ± 0.01

x.xxx = ± 0.005

Materials:

Base: Copper

Lid: Plastic

All metalized features are gold plated

Part is epoxy sealed

Marking:

2578: Part number

YY: Part Assembly year

WW: Part Assembly week

ZZZ: Serial Number

MXXX: Batch ID

Product Compliance Information

ESD Sensitivity Ratings



Caution! ESD-Sensitive Device

ESD Rating: Class 0B
Value: 200 V
Test: Human Body Model (HBM)
Standard: JEDEC JS-001

MSL Rating

Level 5A at 260 °C convection reflow.
The part is rated Moisture Sensitivity Level 5A at 260 °C per JEDEC standard IPC/JEDEC J-STD-020.

ECCN

US Department of Commerce: 3A001.b.2.a

Solderability

Compatible with the latest version of J-STD-020, Lead-free solder, 260°C

RoHS Compliance

This part is compliant with EU 2002/95/EC RoHS directive (Restrictions on the Use of Certain Hazardous Substances in Electrical and Electronic Equipment).

This product also has the following attributes:

- Lead Free
- Halogen Free (Chlorine, Bromine)
- Antimony Free
- TBBP-A (C₁₅H₁₂Br₄O₂) Free
- PFOS Free
- SVHC Free

Contact Information

For the latest specifications, additional product information, worldwide sales and distribution locations, and information about Qorvo:

Web: www.Qorvo.com
Email: info-sales@Qorvo.com

Tel: +1.972.994.8465
Fax: +1.972.994.8504

For technical questions and application information: Email: info-products@Qorvo.com

Important Notice

The information contained herein is believed to be reliable. Qorvo makes no warranties regarding the information contained herein. Qorvo assumes no responsibility or liability whatsoever for any of the information contained herein. Qorvo assumes no responsibility or liability whatsoever for the use of the information contained herein. The information contained herein is provided "AS IS, WHERE IS" and with all faults, and the entire risk associated with such information is entirely with the user. All information contained herein is subject to change without notice. Customers should obtain and verify the latest relevant information before placing orders for Qorvo products. The information contained herein or any use of such information does not grant, explicitly or implicitly, to any party any patent rights, licenses, or any other intellectual property rights, whether with regard to such information itself or anything described by such information.

Qorvo products are not warranted or authorized for use as critical components in medical, life-saving, or life-sustaining applications, or other applications where a failure would reasonably be expected to cause severe personal injury or death.

Данный компонент на территории Российской Федерации

Вы можете приобрести в компании MosChip.

Для оперативного оформления запроса Вам необходимо перейти по данной ссылке:

<http://moschip.ru/get-element>

Вы можете разместить у нас заказ для любого Вашего проекта, будь то серийное производство или разработка единичного прибора.

В нашем ассортименте представлены ведущие мировые производители активных и пассивных электронных компонентов.

Нашей специализацией является поставка электронной компонентной базы двойного назначения, продукции таких производителей как XILINX, Intel (ex.ALTERA), Vicor, Microchip, Texas Instruments, Analog Devices, Mini-Circuits, Amphenol, Glenair.

Сотрудничество с глобальными дистрибьюторами электронных компонентов, предоставляет возможность заказывать и получать с международных складов практически любой перечень компонентов в оптимальные для Вас сроки.

На всех этапах разработки и производства наши партнеры могут получить квалифицированную поддержку опытных инженеров.

Система менеджмента качества компании отвечает требованиям в соответствии с ГОСТ Р ИСО 9001, ГОСТ РВ 0015-002 и ЭС РД 009

Офис по работе с юридическими лицами:

105318, г.Москва, ул.Щербаковская д.3, офис 1107, 1118, ДЦ «Щербаковский»

Телефон: +7 495 668-12-70 (многоканальный)

Факс: +7 495 668-12-70 (доб.304)

E-mail: info@moschip.ru

Skype отдела продаж:

moschip.ru

moschip.ru_4

moschip.ru_6

moschip.ru_9