



# TISP4070L3AJ THRU TISP4395L3AJ

## BIDIRECTIONAL THYRISTOR OVERVOLTAGE PROTECTORS

### TISP4xxxL3AJ Overvoltage Protector Series

**SMA (DO-214AC) Package**  
25% Smaller Placement Area than SMB

**Ion-Implanted Breakdown Region**  
Precise and Stable Voltage

| Device | V <sub>DRM</sub><br>V | V <sub>(BO)</sub><br>V |
|--------|-----------------------|------------------------|
| '4070  | 58                    | 70                     |
| '4080  | 65                    | 80                     |
| '4090  | 70                    | 90                     |
| '4125  | 100                   | 125                    |
| '4145  | 120                   | 145                    |
| '4165  | 135                   | 165                    |
| '4180  | 145                   | 180                    |
| '4220  | 160                   | 220                    |
| '4240  | 180                   | 240                    |
| '4260  | 200                   | 260                    |
| '4290  | 230                   | 290                    |
| '4320  | 240                   | 320                    |
| '4350  | 275                   | 350                    |
| '4360  | 290                   | 360                    |
| '4395  | 320                   | 395                    |

#### SMAJ Package (Top View)



#### Device Symbol



Terminals T and R correspond to the alternative line designators of A and B

..... UL Recognized Components

#### Rated for International Surge Wave Shapes

| Wave Shape | Standard         | I <sub>TSP</sub><br>A |
|------------|------------------|-----------------------|
| 2/10 μs    | GR-1089-CORE     | 125                   |
| 8/20 μs    | IEC 61000-4-5    | 100                   |
| 10/160 μs  | FCC Part 68      | 65                    |
| 10/700 μs  | ITU-T K.20/21/45 | 50                    |
| 10/560 μs  | FCC Part 68      | 40                    |
| 10/1000 μs | GR-1089-CORE     | 30                    |

#### How To Order

| Device       | Package        | Carrier                 | For Standard Termination Finish Order As | For Lead Free Termination Finish Order As |
|--------------|----------------|-------------------------|--|---|
| TISP4xxxL3AJ | SMA (DO-214AC) | Embossed Tape Reel Pack | TISP4xxxL3AJR                            | TISP4xxxL3AJR-S                           |

Insert xxx value corresponding to protection voltages of 070, 080, 090, etc.

\*RoHS Directive 2002/95/EC Jan 27 2003 including Annex JULY 2000 - REVISED FEBRUARY 2005  
Specifications are subject to change without notice.  
Customers should verify actual device performance in their specific applications.

# TISP4xxxL3AJ Overvoltage Protector Series

**BOURNS®**

## Description

These devices are designed to limit overvoltages on the telephone line. Overvoltages are normally caused by a.c. power system or lightning flash disturbances which are induced or conducted on to the telephone line. A single device provides 2-point protection and is typically used for the protection of 2-wire telecommunication equipment (e.g. between the Ring and Tip wires for telephones and modems). Combinations of devices can be used for multi-point protection (e.g. 3-point protection between Ring, Tip and Ground).

The protector consists of a symmetrical voltage-triggered bidirectional thyristor. Overvoltages are initially clipped by breakdown clamping until the voltage rises to the breakover level, which causes the device to crowbar into a low-voltage on state. This low-voltage on state causes the current resulting from the overvoltage to be safely diverted through the device. The high crowbar holding current prevents d.c. latchup as the diverted current subsides.

The TISP4xxxL3 range consists of fifteen voltage variants to meet various maximum system voltage levels (58 V to 320 V). They are guaranteed to voltage limit and withstand the listed international lightning surges in both polarities. These protection devices are in an SMAJ (JEDEC DO-214AC with J-bend leads) plastic package. These devices are supplied in embossed tape reel carrier pack. For alternative voltage and holding current values, consult the factory. For higher rated impulse currents, the 50 A 10/1000 TISP4xxxM3AJ series in SMA and the 100 A 10/1000 TISP4xxxH3BJ series in SMB are available.

## Absolute Maximum Ratings, $T_A = 25\text{ }^\circ\text{C}$ (Unless Otherwise Noted)

| Rating   | Symbol    | Value       | Unit             |
|--|-----------|-------------|------------------|
| Repetitive peak off-state voltage, (see Note 1)  | '4070     | ± 58        | V                |
|  | '4080     | ± 65        |                  |
|  | '4090     | ± 70        |                  |
|  | '4125     | ±100        |                  |
|  | '4145     | ±120        |                  |
|  | '4165     | ±135        |                  |
|  | '4180     | ±145        |                  |
|  | '4220     | ±160        |                  |
|  | '4240     | ±180        |                  |
|  | '4260     | ±200        |                  |
|  | '4290     | ±230        |                  |
|  | '4320     | ±240        |                  |
|  | '4350     | ±275        |                  |
|  | '4360     | ±290        |                  |
|  | '4395     | ±320        |                  |
| Non-repetitive peak on-state pulse current (see Notes 2, 3 and 4)                            | $I_{TSP}$ | 125         | A                |
| 2/10 $\mu\text{s}$ (GR-1089-CORE, 2/10 $\mu\text{s}$ voltage wave shape)                     |           | 100         |                  |
| 8/20 $\mu\text{s}$ (IEC 61000-4-5, combination wave generator, 1.2/50 voltage, 8/20 current) |           | 65          |                  |
| 10/160 $\mu\text{s}$ (FCC Part 68, 10/160 $\mu\text{s}$ voltage wave shape)                  |           | 50          |                  |
| 5/310 $\mu\text{s}$ (ITU-T K.20/21/45, K.44 10/700 $\mu\text{s}$ voltage wave shape)         |           | 50          |                  |
| 5/310 $\mu\text{s}$ (FTZ R12, 10/700 $\mu\text{s}$ voltage wave shape)                       |           | 40          |                  |
| 10/560 $\mu\text{s}$ (FCC Part 68, 10/560 $\mu\text{s}$ voltage wave shape)                  |           | 30          |                  |
| 10/1000 $\mu\text{s}$ (GR-1089-CORE, 10/1000 $\mu\text{s}$ voltage wave shape)               |           |             |                  |
| Non-repetitive peak on-state current (see Notes 2, 3 and 4)                                  | $I_{TSM}$ | 18          | A                |
| 20 ms (50 Hz) full sine wave   |           | 7           |                  |
| 1 s (50 Hz) full sine wave   |           | 1.6         |                  |
| 1000 s 50 Hz/60 Hz a.c.  |           |             |                  |
| Junction temperature   | $T_J$     | -40 to +150 | $^\circ\text{C}$ |
| Storage temperature range  | $T_{stg}$ | -65 to +150 | $^\circ\text{C}$ |

NOTES: 1. For voltage values at lower temperatures, derate at 0.13 %/ $^\circ\text{C}$ .

2. Initially, the TISP4xxxL3 must be in thermal equilibrium with  $T_J = 25\text{ }^\circ\text{C}$ .

3. The surge may be repeated after the TISP4xxxL3 returns to its initial conditions.

4. EIA/JESD51-2 environment and EIA/JESD51-3 PCB with standard footprint dimensions connected with 5 A rated printed wiring track widths. Derate current values at -0.61 %/ $^\circ\text{C}$  for ambient temperatures above  $25\text{ }^\circ\text{C}$ .

# TISP4xxxL3AJ Overvoltage Protector Series

**BOURNS®**

## Recommended Operating Conditions

| Component      |   | Min | Typ | Max | Unit |
|----------------|---|-----|-----|-----|------|
| R <sub>S</sub> | series resistor for FCC Part 68, 10/560 type A surge survival                       | 12  |     |     | Ω    |
|                | series resistor for FCC Part 68, 9/720 type B surge survival                        | 0   |     |     | Ω    |
|                | series resistor for GR-1089-CORE first-level and second-level surge survival        | 23  |     |     | Ω    |
|                | series resistor for K.20, K.21 and K.45 1.5 kV, 10/700 surge survival               | 0   |     |     | Ω    |
|                | series resistor for K.20, K.21 and K.45 coordination with a 400 V primary protector | 7   |     |     | Ω    |

## Electrical Characteristics, T<sub>A</sub> = 25 °C (Unless Otherwise Noted)

| Parameter  | Test Conditions  | Min   | Typ | Max   | Unit  |
|--|--|-------|-----|---|-------|
| I <sub>DRM</sub> Repetitive peak off-state current | V <sub>D</sub> = V <sub>DRM</sub><br>T <sub>A</sub> = 25 °C<br>T <sub>A</sub> = 85 °C  |       |     | ±5<br>±10   | μA    |
| V <sub>(BO)</sub> Breakover voltage                | dv/dt = ±250 V/ms, R <sub>SOURCE</sub> = 300 Ω   |       |     | ±70<br>±80<br>±90<br>±125<br>±145<br>±165<br>±180<br>±220<br>±240<br>±260<br>±290<br>±320<br>±350<br>±360<br>±395 | V     |
| I <sub>(BO)</sub> Breakover current                | dv/dt = ±250 V/ms, R <sub>SOURCE</sub> = 300 Ω   |       |     | ±0.8  | A     |
| I <sub>H</sub> Holding current                     | I <sub>T</sub> = ±5 A, di/dt = +/-30 mA/ms   | ±0.15 |     | ±0.60   | A     |
| dv/dt Critical rate of rise of off-state voltage   | Linear voltage ramp, Maximum ramp value < 0.85V <sub>DRM</sub>   | ±5    |     |   | kV/μs |
| I <sub>D</sub> Off-state current                   | '4070, V <sub>D</sub> = ±52 V<br>'4080, V <sub>D</sub> = ±59 V<br>'4090, V <sub>D</sub> = ±63 V<br>'4125, V <sub>D</sub> = ±90 V<br>'4145, V <sub>D</sub> = ±108 V<br>'4165, V <sub>D</sub> = ±122 V<br>'4180, V <sub>D</sub> = ±131 V<br>'4220, V <sub>D</sub> = ±144 V<br>'4240, V <sub>D</sub> = ±162 V<br>'4260, V <sub>D</sub> = ±180 V<br>'4290, V <sub>D</sub> = ±207 V<br>'4320, V <sub>D</sub> = ±216 V<br>'4350, V <sub>D</sub> = ±248 V<br>'4360, V <sub>D</sub> = ±261 V<br>'4395, V <sub>D</sub> = ±288 V |       |     | ±2  | μA    |
| I <sub>D</sub> Off-state current                   | V <sub>D</sub> = ±50 V   |       |     | ±10   | μA    |

JULY 2000 - REVISED FEBRUARY 2005

Specifications are subject to change without notice.

Customers should verify actual device performance in their specific applications.

# TISP4xxxL3AJ Overvoltage Protector Series

**BOURNS®**

## Electrical Characteristics, $T_A = 25\text{ }^\circ\text{C}$ (Unless Otherwise Noted) (Continued)

| Parameter                       | Test Conditions   | Min              | Typ | Max | Unit |
|---------------------------------|---|------------------|-----|-----|------|
| $C_{off}$ Off-state capacitance | $f = 1\text{ MHz}$ , $V_d = 1\text{ V rms}$ , $V_D = \pm 1\text{ V}$  | 4070 thru '4090  | 53  | 64  | pF   |
|                                 |   | '4125 thru '4220 | 40  | 48  |      |
|                                 |   | '4240 thru '4395 | 33  | 40  |      |
|                                 | $f = 1\text{ MHz}$ , $V_d = 1\text{ V rms}$ , $V_D = \pm 50\text{ V}$ | '4070 thru '4090 | 25  | 30  |      |
|                                 |   | '4125 thru '4220 | 18  | 22  |      |
|                                 |   | '4240 thru '4395 | 14  | 17  |      |

## Thermal Characteristics

| Parameter   | Test Conditions   | Min | Typ | Max | Unit               |
|---|---|-----|-----|-----|--------------------|
| $R_{\theta JA}$ Junction to free air thermal resistance | EIA/JESD51-3 PCB, $I_T = I_{TSM(1000)}$ ,<br>$T_A = 25\text{ }^\circ\text{C}$ , (see Note 75)                 |     |     | 115 | $^\circ\text{C/W}$ |
|   | 265 mm x 210 mm populated line card,<br>4-layer PCB, $I_T = I_{TSM(1000)}$ , $T_A = 25\text{ }^\circ\text{C}$ |     | 52  |     |                    |

NOTE 5: EIA/JESD51-2 environment and PCB has standard footprint dimensions connected with 5 A rated printed wiring track widths.

## Parameter Measurement Information



**Figure 1. Voltage-Current Characteristic for T and R Terminals**  
**All Measurements are Referenced to the R Terminal**

PMXXAAB

## Typical Characteristics

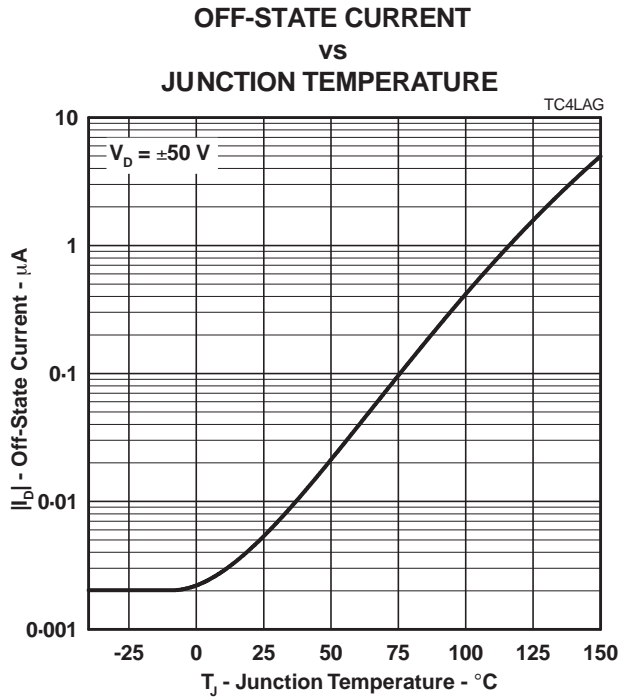

Figure 2.

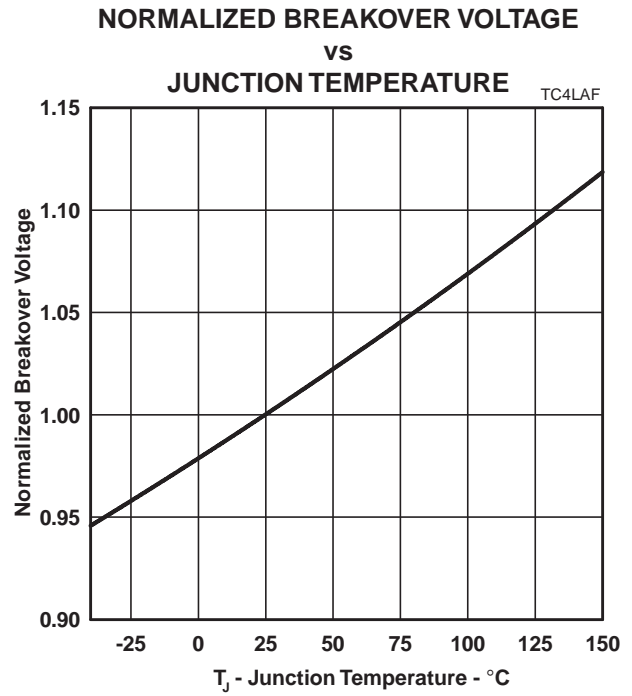

Figure 3.

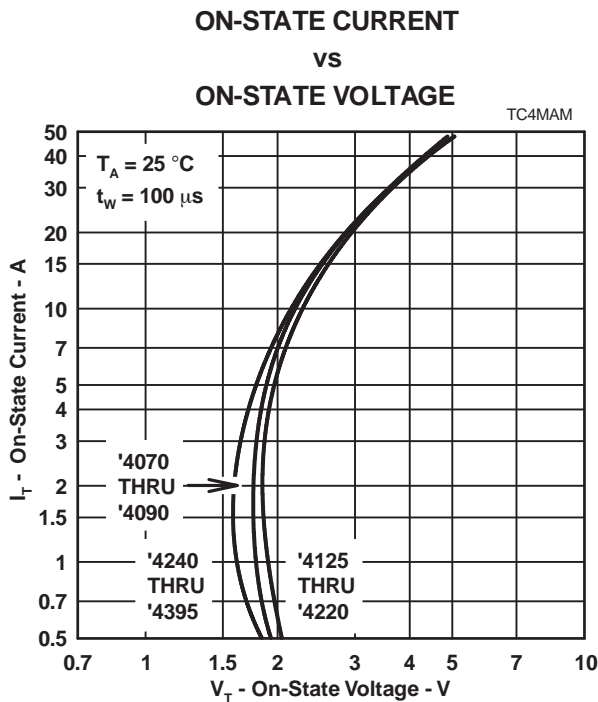

Figure 4.

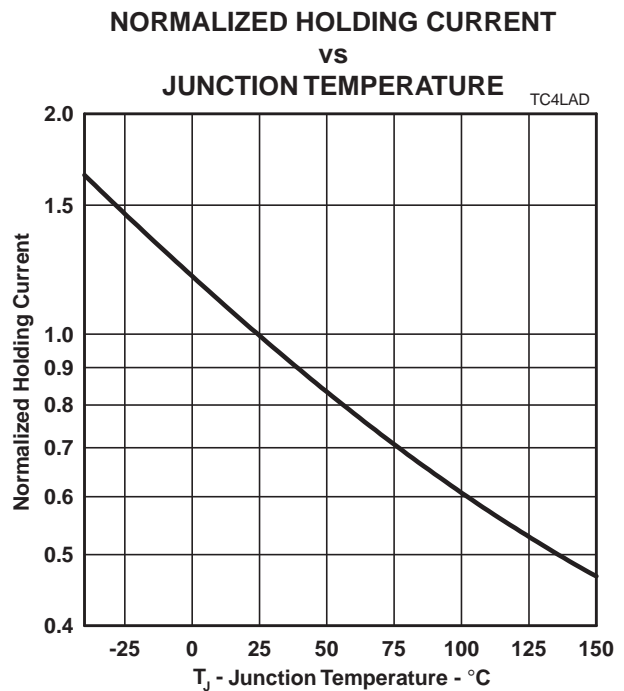

Figure 5.

## Typical Characteristics



Figure 6.

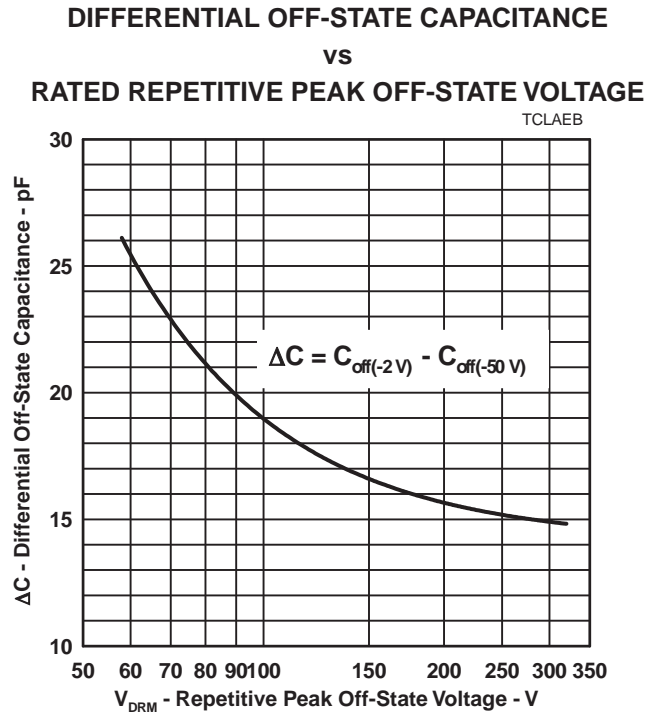

Figure 7.

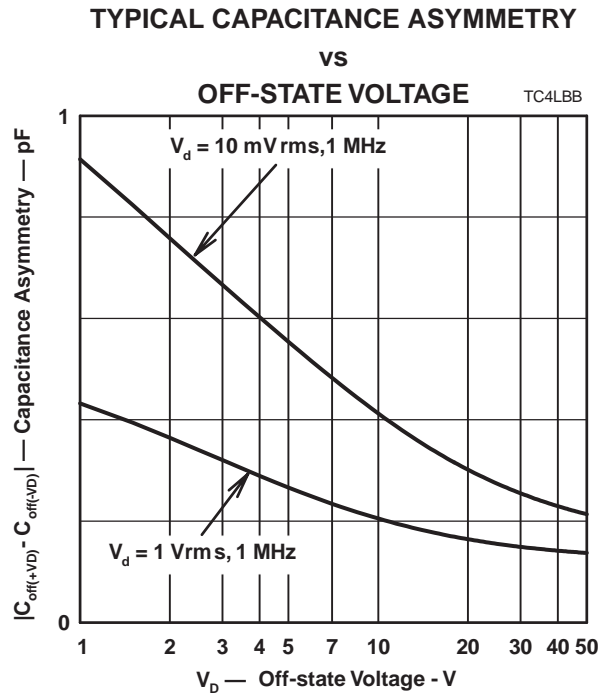

Figure 6.

## Rating and Thermal Information

### NON-REPETITIVE PEAK ON-STATE CURRENT vs CURRENT DURATION



Figure 9.

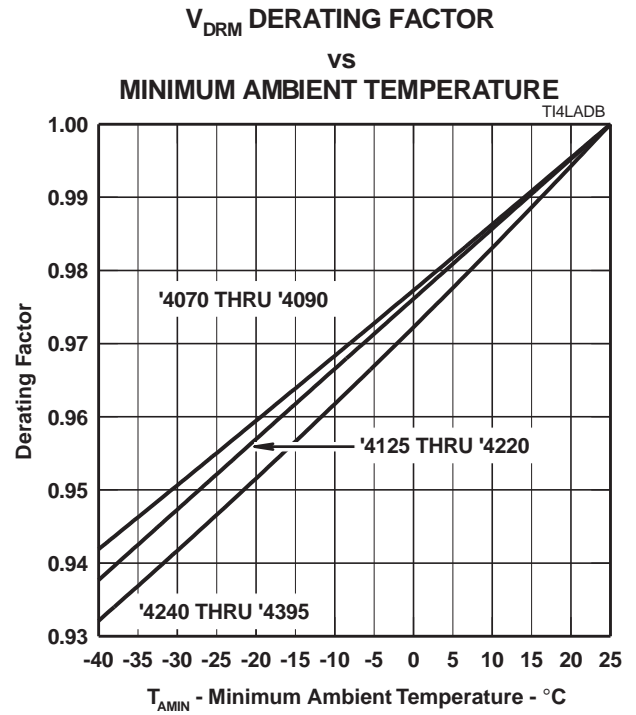

Figure 10.



# TISP4xxxL3AJ Overvoltage Protector Series

**BOURNS®**

## MECHANICAL DATA

### Recommended Printed Wiring Land Pattern Dimensions



MDXXBIC

### Device Symbolization Code

Devices will be coded as below. As the device parameters are symmetrical, terminal 1 is not identified.

| Device     | Symbolization Code |
|------------|--------------------|
| TISP4070L3 | 4070L              |
| TISP4080L3 | 4080L              |
| TISP4090L3 | 4090L              |
| TISP4125L3 | 4125L              |
| TISP4145L3 | 4145L              |
| TISP4165L3 | 4165L              |
| TISP4180L3 | 4180L              |
| TISP4220L3 | 4220L              |
| TISP4240L3 | 4240L              |
| TISP4260L3 | 4260L              |
| TISP4290L3 | 4290L              |
| TISP4320L3 | 4320L              |
| TISP4350L3 | 4350L              |
| TISP4360L3 | 4360L              |
| TISP4395L3 | 4395L              |

### Carrier Information

For production quantities, the carrier will be embossed tape reel pack. Evaluation quantities may be shipped in bulk pack or embossed tape.

| Carrier                 | Standard Quantity |
|-------------------------|-------------------|
| Embossed Tape Reel Pack | 5,000             |

# TISP4xxxL3AJ Overvoltage Protector Series



## MECHANICAL DATA

### SMAJ (DO-214AC) Plastic Surface Mount Diode Package

This surface mount package consists of a circuit mounted on a lead frame and encapsulated within a plastic compound. The compound will withstand soldering temperature with no deformation, and circuit performance characteristics will remain stable when operated in high humidity conditions. Leads require no additional cleaning or processing when used in soldered assembly.

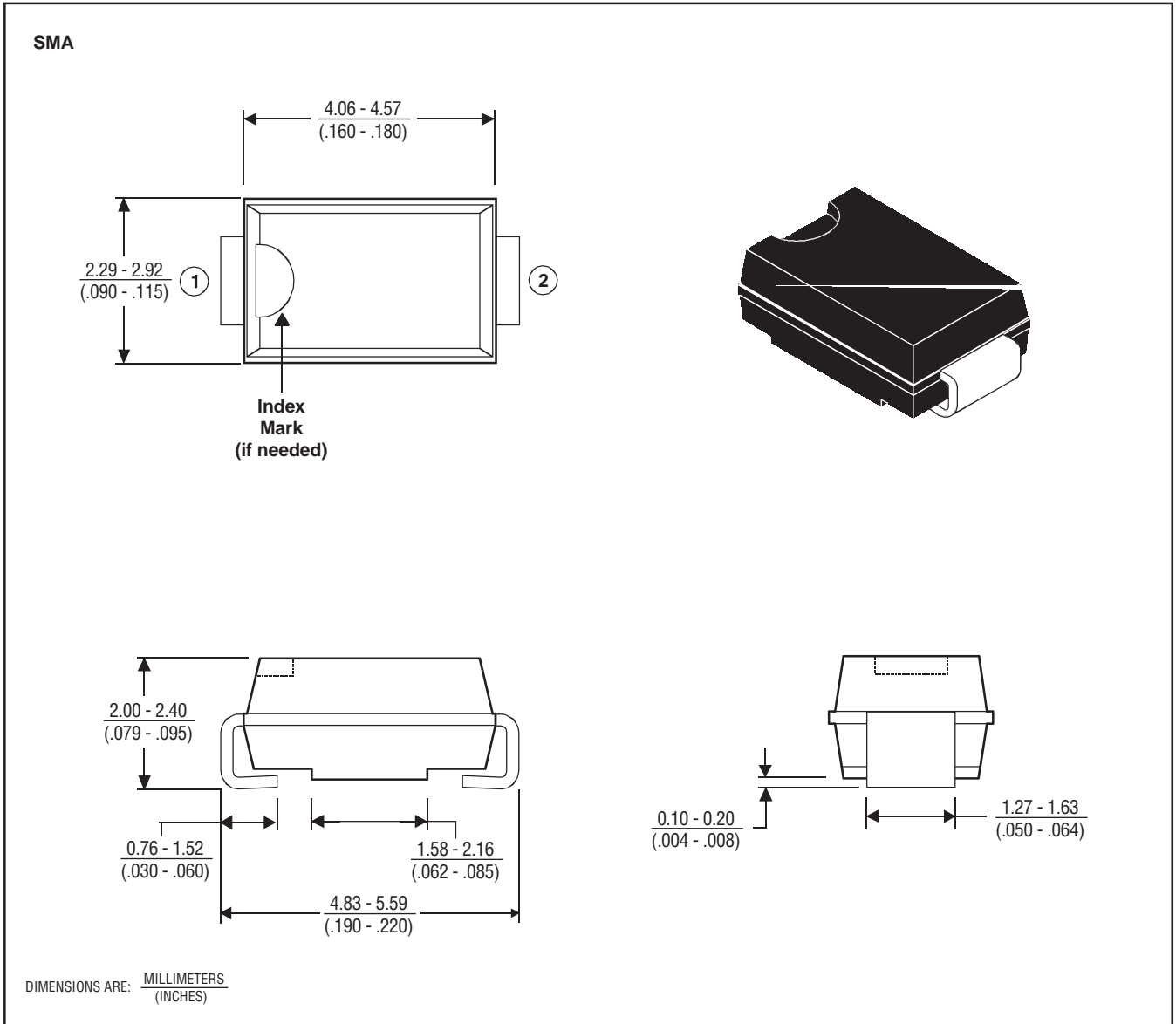

MDXCAA

# TISP4xxxL3AJ Overvoltage Protector Series

**BOURNS®**

## MECHANICAL DATA

### Tape Dimensions



NOTES: A. The clearance between the component and the cavity must be within 0.05 mm (.002 in) MIN. to 0.65 mm (.026 in) MAX. so that the component cannot rotate more than 20° within the determined cavity. MDXXCGA

B. Taped devices are supplied on a reel of the following dimensions:

Reel diameter: 330 mm ± 3.0 mm (12.99 in ± .12 in)  
 Reel hub diameter: 75 mm (2.95 in) MIN.  
 Reel axial hole: 13.0 mm ± 0.5 mm (.51 in ± .02 in)

C. 5000 devices per reel.

## Данный компонент на территории Российской Федерации

### Вы можете приобрести в компании MosChip.

Для оперативного оформления запроса Вам необходимо перейти по данной ссылке:

<http://moschip.ru/get-element>

Вы можете разместить у нас заказ для любого Вашего проекта, будь то серийное производство или разработка единичного прибора.

В нашем ассортименте представлены ведущие мировые производители активных и пассивных электронных компонентов.

Нашей специализацией является поставка электронной компонентной базы двойного назначения, продукции таких производителей как XILINX, Intel (ex.ALTERA), Vicor, Microchip, Texas Instruments, Analog Devices, Mini-Circuits, Amphenol, Glenair.

Сотрудничество с глобальными дистрибьюторами электронных компонентов, предоставляет возможность заказывать и получать с международных складов практически любой перечень компонентов в оптимальные для Вас сроки.

На всех этапах разработки и производства наши партнеры могут получить квалифицированную поддержку опытных инженеров.

Система менеджмента качества компании отвечает требованиям в соответствии с ГОСТ Р ИСО 9001, ГОСТ РВ 0015-002 и ЭС РД 009

### Офис по работе с юридическими лицами:

105318, г.Москва, ул.Щербаковская д.3, офис 1107, 1118, ДЦ «Щербаковский»

Телефон: +7 495 668-12-70 (многоканальный)

Факс: +7 495 668-12-70 (доб.304)

E-mail: [info@moschip.ru](mailto:info@moschip.ru)

Skype отдела продаж:

moschip.ru

moschip.ru\_4

moschip.ru\_6

moschip.ru\_9