

# POWER OVER ETHERNET (PoE) MAGNETICS

## 10/100BASE-TX VoIP Magnetics Modules

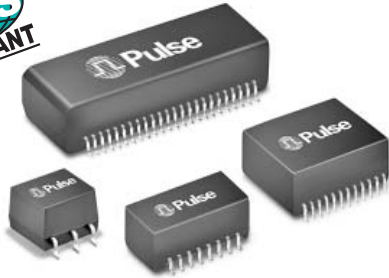

- RoHS peak reflow temperature rating 245°C
- IEEE 802.3af/ANSI X3.263 compliant performance
- Designed for IP phone or switch applications

### Electrical Specifications @ 25°C — Operating Temperature 0°C to 70°C

Part Number	Ports	Insertion Loss (dB MAX)	Return Loss (dB MIN @ 100 Ω)					Differential to Common Mode Rejection (dB MIN)			Cross Talk (dB MIN)			Hipot (Vrms MIN))	DC Resistance Balance ≤ (%)
			1-100 MHz	1-30 MHz	40 MHz	50 MHz	60-80 MHz	30 MHz	60 MHz	100 MHz	30 MHz	60 MHz	100 MHz		
H1187NL <sup>2a</sup>	1	-1.2	-16	-14	-13	-12	-43	-37	-33	-45	-40	-35	1500	—	
H1197NL <sup>2a</sup>	1	-1.2	-16	-14	-13	-12	-43	-37	-33	-45	-40	-35	1500	—	
H2019NL <sup>2a</sup>	1	-1.2	-16	-14	-13	-12	-43	-37	-33	-45	-40	-35	1500	3.5	
H2005ANL <sup>2c</sup>	2	-1.2	-16	-14	-13	-12	-50	-43	-35	-43	-37	-33	1500	3.5	
H2006ANL <sup>2c</sup>	2	-1.2	-16	-14	-13	-12	-43	-37	-33	-43	-37	-31	1500	3.5	
H2008NL <sup>2c</sup>	2	-1.2	-16	-14	-13	-12	-40	-35	-30	-43	-37	-33	1500	3.5	
H2009NL <sup>2a</sup>	2	-1.1	-16	-14	-13	-12	-43	-37	-33	-43	-37	-33	1500	3.5	
H2014NL <sup>2d</sup>	4	-1.2	-16	-14	-13	-12	-43	-37	-33	-45	-40	-35	1500	3.5	
H2017NL <sup>2c</sup>	4	-1.2	-16	-14	-13	-12	-43	-37	-33	-45	-40	-35	1800	3.5	
HX2019NL <sup>1,2a</sup>	1	-1.4	-16	-14	-13	-12	-43	-37	-33	-45	-40	-35	1500	3.5	

1. **Extended** operating temperature (-40°C to +85°C)
2. **MSL** (Moisture Sensitivity Level): a = 1, b = 2, c = 3, d = 4, e = 5

**NOTE:** When ordering Tape & Reel packaging, add the suffix "T" to the end of the part number. For example: H2008NLT.

## Mechanics

### H1187NL

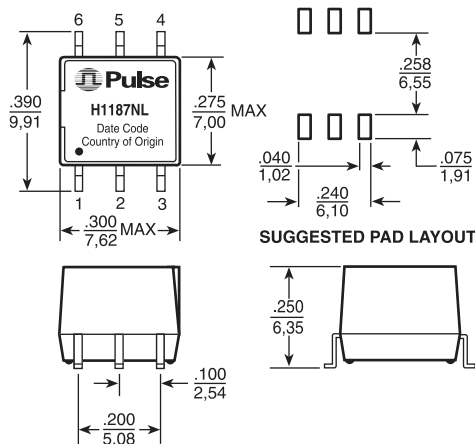

Weight . . . . . 0.6 grams  
Tape & Reel . . . . . 500/reel  
Tube . . . . . 70/tube

### H1197NL

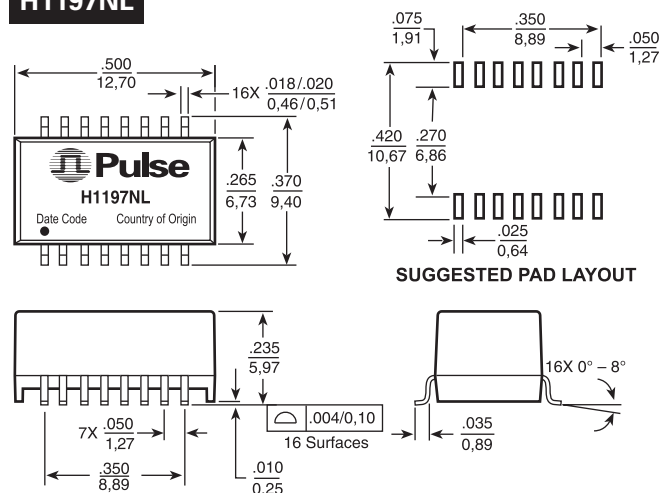

Weight . . . . . 2.8 grams  
Tape & Reel . . . . . 600/reel  
Tube . . . . . 45/tube

Dimensions:  $\frac{\text{Inches}}{\text{mm}}$  Unless otherwise specified, all tolerances are  $\pm \frac{.010}{0,25}$

# POWER OVER ETHERNET (PoE) MAGNETICS

## 10/100BASE-TX VoIP Magnetics Modules



### Mechanicals

#### H2019NL, HX2019NL

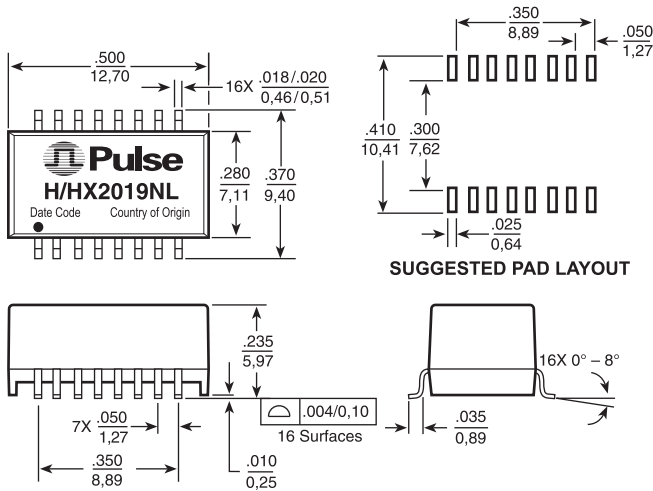

#### H2005ANL

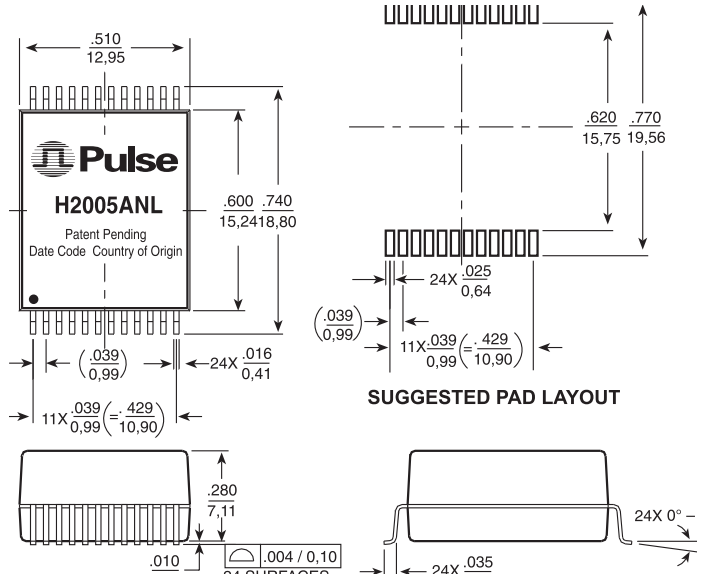

Weight . . . . . 1.0 grams  
Tape & Reel . . . . . 600/reel  
Tube . . . . . 45/tube

Dimensions:  $\frac{\text{Inches}}{\text{mm}}$  Unless otherwise specified, all tolerances are  $\pm \frac{.010}{0,25}$

Weight . . . . . 2.7 grams  
Tape & Reel . . . . . 300/reel  
Tube . . . . . 25/tube

#### H2006ANL, H2008NL

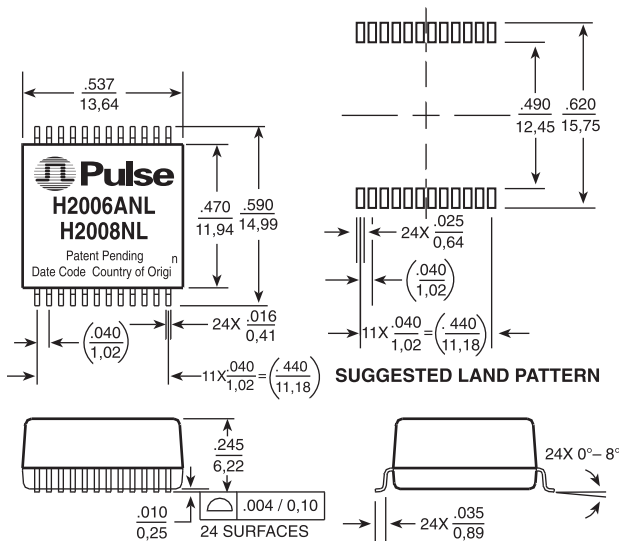

#### H2009NL

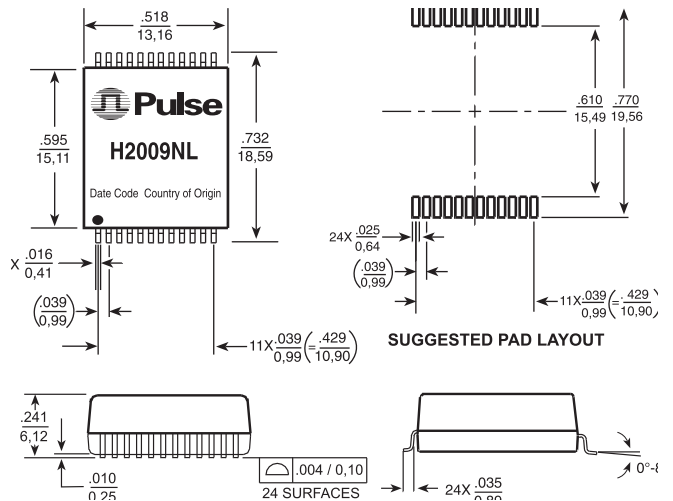

Weight . . . . . 2.4 grams  
Tape & Reel . . . . . 350/reel  
Tube . . . . . 35/tube

Dimensions:  $\frac{\text{Inches}}{\text{mm}}$  Unless otherwise specified, all tolerances are  $\pm \frac{.010}{0,25}$

Weight . . . . . 1.6 grams  
Tape & Reel . . . . . 300/reel  
Tube . . . . . 35/tube

# POWER OVER ETHERNET (PoE) MAGNETICS

## 10/100BASE-TX VoIP Magnetics Modules



### Mechanicals (continued)

#### H2014NL, H2017NL

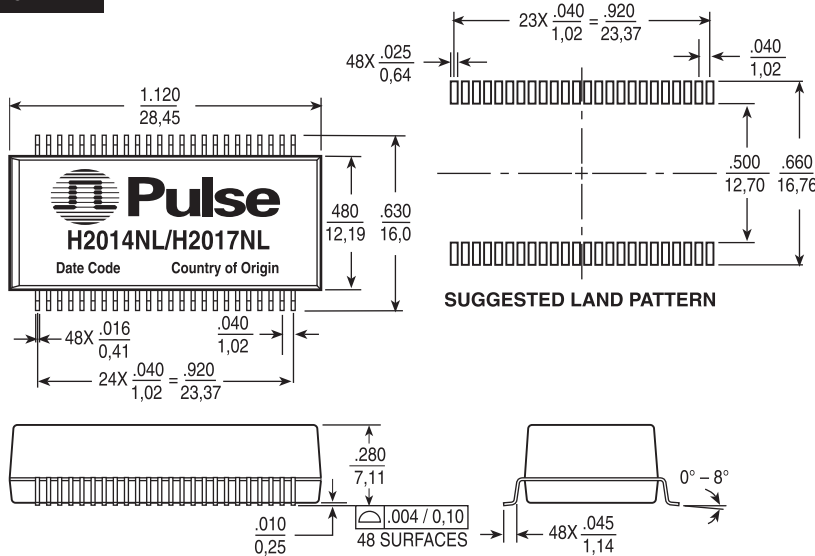

Dimensions:  $\frac{\text{Inches}}{\text{mm}}$  Unless otherwise specified, all tolerances are  $\pm \frac{.010}{0.25}$

Weight . . . . . 5.0 grams  
Tape & Reel . . . . . 250 /reel  
Tube . . . . . 15/tube

### Schematics

#### H2019NL, HX2019NL

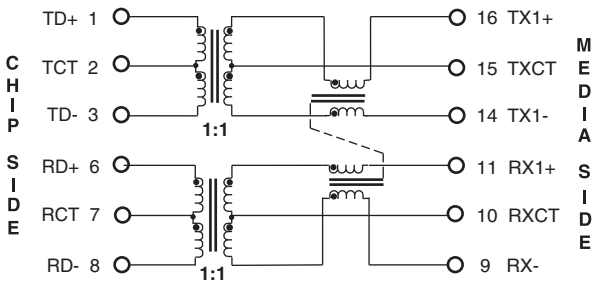

#### H1187NL

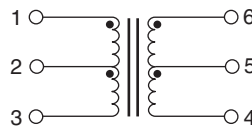

#### H1197NL

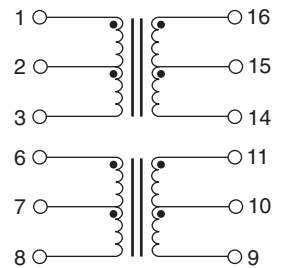

# POWER OVER ETHERNET (PoE) MAGNETICS

## 10/100BASE-TX VoIP Magnetics Modules



### Schematics (continued)

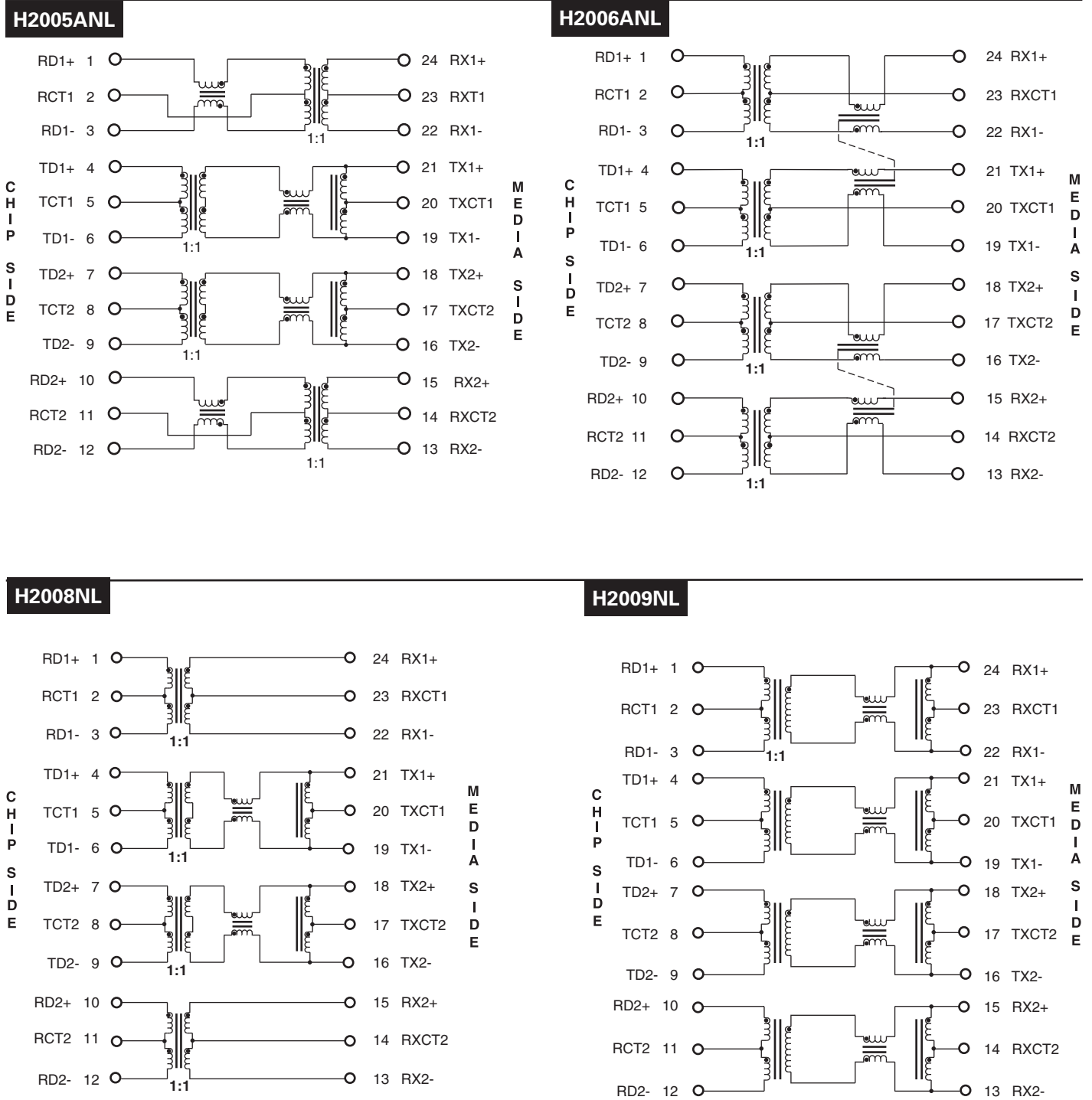

# POWER OVER ETHERNET (PoE) MAGNETICS

## 10/100BASE-TX VoIP Magnetics Modules



### Schematics (continued)

#### H2014NL

#### MEDIA SIDE

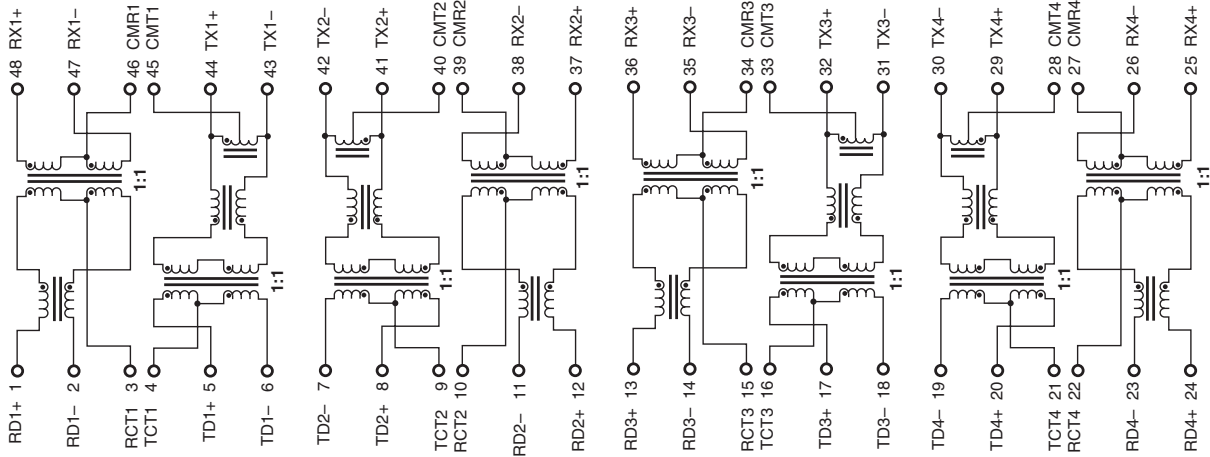

#### CHIP SIDE

#### H2017NL

#### MEDIA SIDE

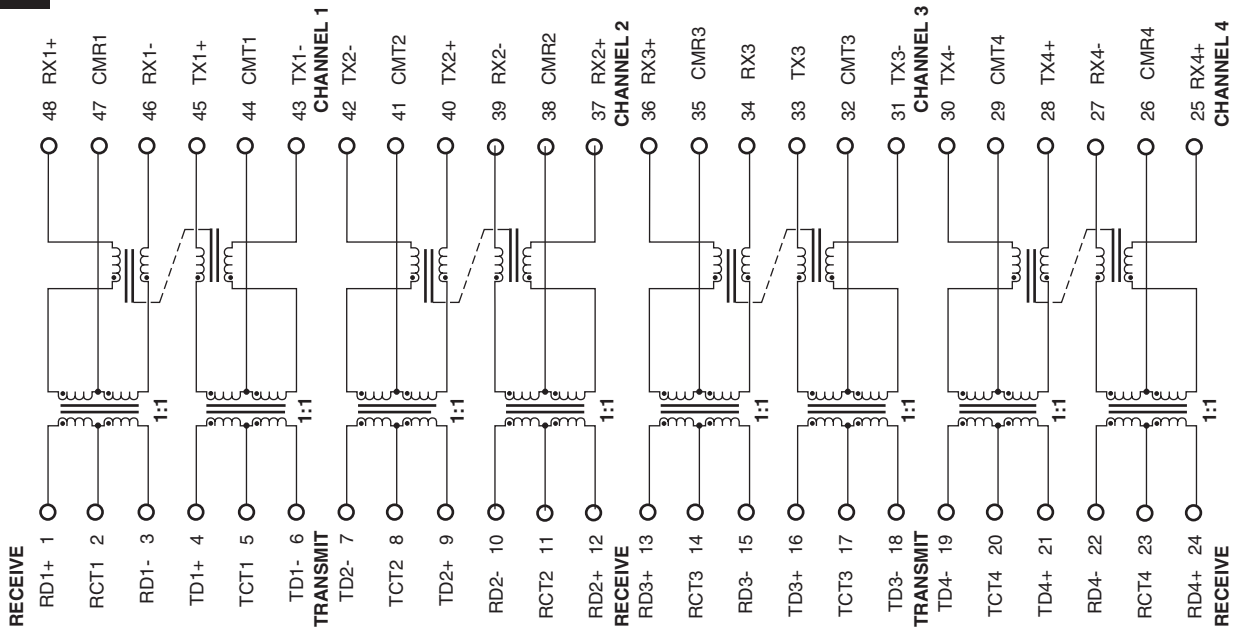

#### CHIP SIDE

### For More Information:

**Pulse Worldwide Headquarters**  
12220 World Trade Dr.  
San Diego, CA 92128  
U.S.A.

**Pulse Europe**  
Einsteinstrasse 1  
D-71083 Herrenberg  
Germany

**Pulse China Headquarters**  
B402, Shenzhen Academy of  
Aerospace Technology Bldg.  
10th Kejinan Rd.  
High-Tech Zone  
Nanshan District  
Shenzhen, PR China 518057

**Pulse North China**  
Room 1503  
XinYin Building  
No. 888 YiShan Rd.  
Shanghai 200233  
China

**Pulse South Asia**  
135 Joo Seng Rd.  
#03-02  
PM Industrial Bldg.  
Singapore 368363

**Pulse North Asia**  
No. 26, Kao Ching Rd.  
Yang Mei Chen  
Taoyuan Hsien  
Taiwan  
R. O. C.

[www.pulseeng.com](http://www.pulseeng.com)

Tel: 858 674 8100  
Fax: 858 674 8262

Tel: 49 7032 7806 0  
Fax: 49 7032 7806 135

TEL: 86 755 33966678  
FAX: 86 755 33966700

Tel: 86 21 54643211/2  
Fax: 86 21 54643210

TEL: 65 6287 8998  
FAX: 65 6280 0080

Tel: 886 3 4643715  
Fax: 886 3 4641911

Performance warranty of products offered on this data sheet is limited to the parameters specified. Data is subject to change without notice. Other brand and product names mentioned herein may be trademarks or registered trademarks of their respective owners.

© Copyright, 2009, Pulse Engineering, Inc. All rights reserved.

## Данный компонент на территории Российской Федерации

### Вы можете приобрести в компании MosChip.

Для оперативного оформления запроса Вам необходимо перейти по данной ссылке:

<http://moschip.ru/get-element>

Вы можете разместить у нас заказ для любого Вашего проекта, будь то серийное производство или разработка единичного прибора.

В нашем ассортименте представлены ведущие мировые производители активных и пассивных электронных компонентов.

Нашей специализацией является поставка электронной компонентной базы двойного назначения, продукции таких производителей как XILINX, Intel (ex.ALTERA), Vicor, Microchip, Texas Instruments, Analog Devices, Mini-Circuits, Amphenol, Glenair.

Сотрудничество с глобальными дистрибьюторами электронных компонентов, предоставляет возможность заказывать и получать с международных складов практически любой перечень компонентов в оптимальные для Вас сроки.

На всех этапах разработки и производства наши партнеры могут получить квалифицированную поддержку опытных инженеров.

Система менеджмента качества компании отвечает требованиям в соответствии с ГОСТ Р ИСО 9001, ГОСТ РВ 0015-002 и ЭС РД 009

### Офис по работе с юридическими лицами:

105318, г.Москва, ул.Щербаковская д.3, офис 1107, 1118, ДЦ «Щербаковский»

Телефон: +7 495 668-12-70 (многоканальный)

Факс: +7 495 668-12-70 (доб.304)

E-mail: [info@moschip.ru](mailto:info@moschip.ru)

Skype отдела продаж:

moschip.ru

moschip.ru\_4

moschip.ru\_6

moschip.ru\_9