

### LSP05 Module Series



#### Description

The Littelfuse LSP05 thermally protected Surge Protective Device is a self-protected device which is specially designed to be used in outdoor and commercial LED lighting fixtures for transient overvoltage protection. It is constructed with Littelfuse thermally protected varistor technology. Its built-in thermal disconnect function provides additional protection to prevent catastrophic failure and fire hazard even under the extreme circumstances of varistor end-of-life or sustaining over voltage conditions. The LSP05 SPD facilitates customer's product compliance to IEEE C62.41.2 Location Category C Low and US Dept of Energy MSSLC Model Spec.

#### Agency Approvals

Agency	Standard	Agency File Number
	UL1449 3rd Edition	E320116

#### Applications

- Outdoor and Commercial LED Lighting
- Roadway lighting
- Traffic lighting
- Digital signage
- Wash wall lighting
- Parking garage/lot lighting
- Flood lighting
- Tunnel lighting
- Street lighting

#### Features

- Maximum Discharge Current, 10kA, 8/20us
- Meets ANSI C136.2/ IEEE C62.41.2 Location Category C Low Exposure
- Parallel connected SPD device
- Thermally protected Varistor technology
- IP66 Water-proof and Dust-proof
- Indication wire lead options for Parallel connected modules
- CE Compliance IEC61643-11 Class II/ EN61643-11 Type 2
- Compact form factor (48x48x30mm) with mounting tabs
- 240Vac and 277Vac voltage ratings are CE compliant and available for Class I and Class II installation based on IEC protection classes

#### Additional Information



Datasheet



Resources



Samples

#### Notes:

- These parts are in compliance with IEC61643-11 Class II (Low Voltage System) and EN61643-11 Type 2 (Low Voltage System).
- Tested for temporary overvoltage from low-voltage system faults per IEC 61643-11

#### Absolute Maximum Ratings

• For ratings of individual members of a series, see Device Ratings and Specifications chart

	LSP05 Series	Units
<b>Continous:</b>		
<b>Steady State Applied Voltage:</b>		
Max AC Voltage Range ( $V_{M(ACRMS)}$ )	150 to 510	V
<b>Transient:</b>		
Maximum Discharge Current 8/20 $\mu$ s Waveform ( $I_{max}$ )	10,000	A
Nominal Discharge Current 8/20 $\mu$ s Waveform ( $I_n$ )	5,000	A
Operating Ambient Temperature Range ( $T_A$ )	-45 to +85	°C
Storage Temperature Range ( $T_{STG}$ )	-45 to +125	°C
Isolation Voltage Capability (When the thermal disconnect opens)	600	V
Insulation Resistance	>1,000	M $\Omega$

**CAUTION:** Stresses above those listed in "Absolute Maximum Ratings" may cause permanent damage to the device. This is a stress only rating and operation of the device at these or any other conditions above those indicated in the operational sections of this specification is not implied.

## LSP05 Series Device Ratings & Specifications

Part Number	Operating Voltage (VAC)	MCOV/Uc (VAC)	Maximum Discharge Current (Imax)(A) <sup>2</sup>	Nominal Discharge Current (In)(A) <sup>1</sup>	MLV (V) <sup>3</sup>	Up (V) <sup>4</sup>
LSP05120P	120	150	10,000	5,000	L-N:680 L-G:680 N-G:630	800
LSP05240P	240	275	10,000	5,000	L-N:1100 L-G:1100 N-G:1100	1200
LSP05277P	277	320	10,000	5,000	L-N:1270 L-G:1270 N-G:1220	1400
LSP05347P	347	420	10,000	5,000	L-N:1600 L-G:1600 N-G:1580	1700
LSP05480P	480	510	10,000	5,000	L-N:1780 L-G:1780 N-G:1730	1900
LSP05240LLP	L-L:240	L-L:275	10,000	5,000	L-L:1100	L-L:1200
	L-N/G:120	L-N/G:150			L-N/G:680	L-N/G:800
LSP05480LLP	L-L:480	L-L:510	10,000	5,000	L-L:1780	L-L:1900
	L-N/G:277	L-N/G:320			L-N/G:1270	L-N/G:1400

Notes:

- Nominal Discharge Current (In)(A): The nominal discharge current is a measure of the SPDs endurance capability; 15 impulses of discharge current uses the 8/20us current waveform.
- Maximum Discharge Current (Imax)(A): The maximum discharge current is a measure of the SPDs maximum capability; single impulse of discharge current uses the 8/20us current waveform.
- MLV – UL1449 Measured limiting voltage; the highest value of residual voltage measurements during the application of impulses of 8/20us nominal discharge current (In); an average voltage value of 15 impulses
- Up – IEC 61643-11 Voltage protection level; the highest value of residual voltage measurements during the application of impulses of 8/20us nominal discharge current (In); a rounding voltage value of maximum measurement.

## Dimensions



Notes:

- Black: Line; White: Neutral; Green: Ground  
(P/N with suffix X3333/X3316: Brown: Line; Blue: Neutral; Green-Yellow stripe: Ground)
- Black: R1; Red: R2; Blue: R3
- Wire Gauge: AWG14 wire Line in, AWG22 Wire for indication; Wire Length: 100mm or customized

**Application/Installation Schematic**



Notes:  
1. LED indicator and associated circuitry are not included in the module.

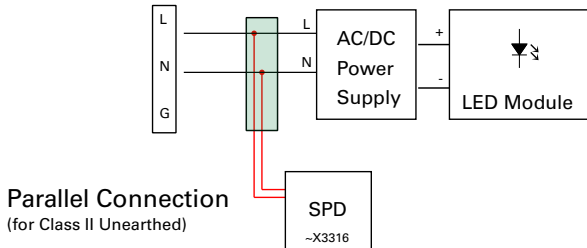
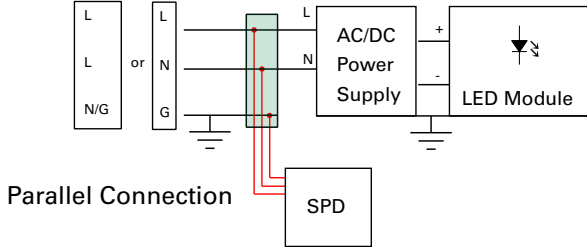

**Part Numbering System**

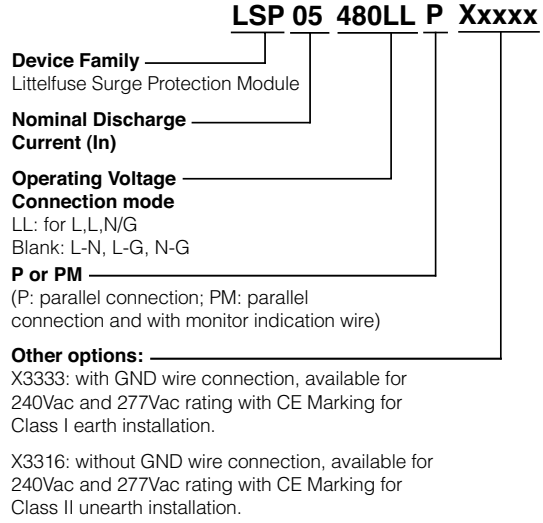

## Данный компонент на территории Российской Федерации

### Вы можете приобрести в компании MosChip.

Для оперативного оформления запроса Вам необходимо перейти по данной ссылке:

<http://moschip.ru/get-element>

Вы можете разместить у нас заказ для любого Вашего проекта, будь то серийное производство или разработка единичного прибора.

В нашем ассортименте представлены ведущие мировые производители активных и пассивных электронных компонентов.

Нашей специализацией является поставка электронной компонентной базы двойного назначения, продукции таких производителей как XILINX, Intel (ex.ALTERA), Vicor, Microchip, Texas Instruments, Analog Devices, Mini-Circuits, Amphenol, Glenair.

Сотрудничество с глобальными дистрибьюторами электронных компонентов, предоставляет возможность заказывать и получать с международных складов практически любой перечень компонентов в оптимальные для Вас сроки.

На всех этапах разработки и производства наши партнеры могут получить квалифицированную поддержку опытных инженеров.

Система менеджмента качества компании отвечает требованиям в соответствии с ГОСТ Р ИСО 9001, ГОСТ РВ 0015-002 и ЭС РД 009

### Офис по работе с юридическими лицами:

105318, г.Москва, ул.Щербаковская д.3, офис 1107, 1118, ДЦ «Щербаковский»

Телефон: +7 495 668-12-70 (многоканальный)

Факс: +7 495 668-12-70 (доб.304)

E-mail: [info@moschip.ru](mailto:info@moschip.ru)

Skype отдела продаж:

moschip.ru

moschip.ru\_4

moschip.ru\_6

moschip.ru\_9