

SINGLE ISOLATION AMPLIFIER

■ GENERAL DESCRIPTION

NJM2505A is the single isolation amplifier developed by the video signal. It can remove the noise of a signal with isolation amplifier and carries in the small package (MTP5), it is suitable for the interface of the video signal of a car AV system.

■ FEATURES

- Operating Voltage 4.5 to 9.0V
- Input: Sync-tip Clamp
- Common Mode Noise Rejection Ratio -55dBtyp.
- Voltage Gain 0dBtyp.
- Frequency Characteristics 0dBtyp.at 10MHz
- Bipolar Technology
- Package MTP5

■ PIN CONFIGURATION

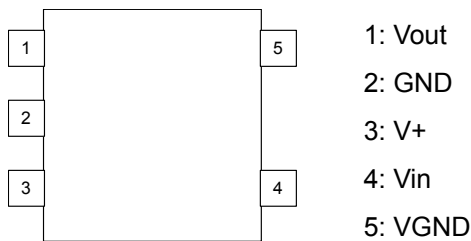

■ BLOCK DIAGRAM

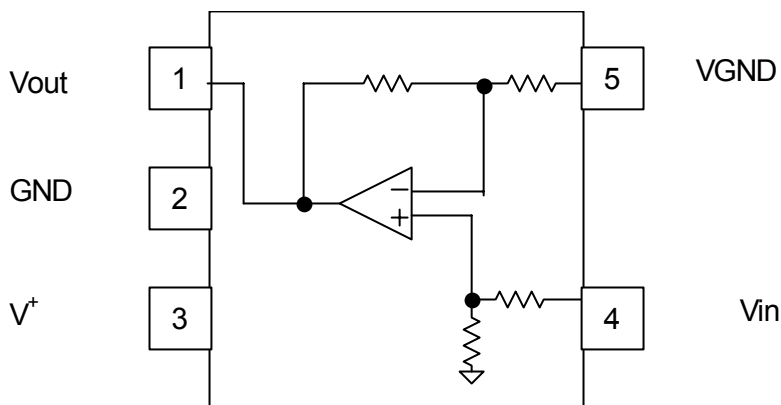

■ PACKAGE OUTLINE



NJM2505AF

NJM2505A

■ ABSOLUTE MAXIMUM RATINGS(Ta=25°C)

PARAMETER	SYMBOL	RATINGS	UNIT
Supply Voltage	V ⁺	15.0	V
Power Dissipation	P _D	200	MW
Operating Temperature Range	Topr	-40 to +85	°C
Storage Temperature Range	Tstg	-40 to +125	°C

■ RECOMMENDED OPERATING CONDITION(Ta=25°C)

PARAMETER	SYMBOL	TEST CONDITION	MIN.	TYP.	MAX.	UNIT
Operating Voltage Range	Vopr		4.5	-	9.0	V

■ ELECTRICAL CHARACTERISTICS(V⁺ =5.0V, Ta=25°C)

PARAMETR	SYMBOL	TEST CONDITION	MIN.	TYP.	MAX.	UNIT
Supply Current	I _{CC}	No Signal	-	3.0	6.0	mA
Maximum Output Voltage Level	Vom	Vin=100kHz, Sin-Signal, THD=1%,	2.0	2.2	-	Vp-p
Voltage Gain	Gv	Vin=100kHz, 1.0Vp-p, Sin-Signal	-1.0	0	1.0	dB
Frequency Characteristics	Gf	Vin=10MHz / 1MHz , 1.0VppSin-Signal	-1.0	0	1.0	dB
Common Mode Noise Rejection Ratio	CMR	Vin=20KHz, Vin=1Vpp	-	-55	-	dB
Differential Gain	DG	Vin=1.0Vp-p, 10step Video Signal	-	0.3	-	%
Differential Phase	DP	Vin=1.0Vp-p, 10step Video Signal	-	0.4	-	deg

■ TEST CIRCUIT

When CMR is measured, VGND is connected with VIN.

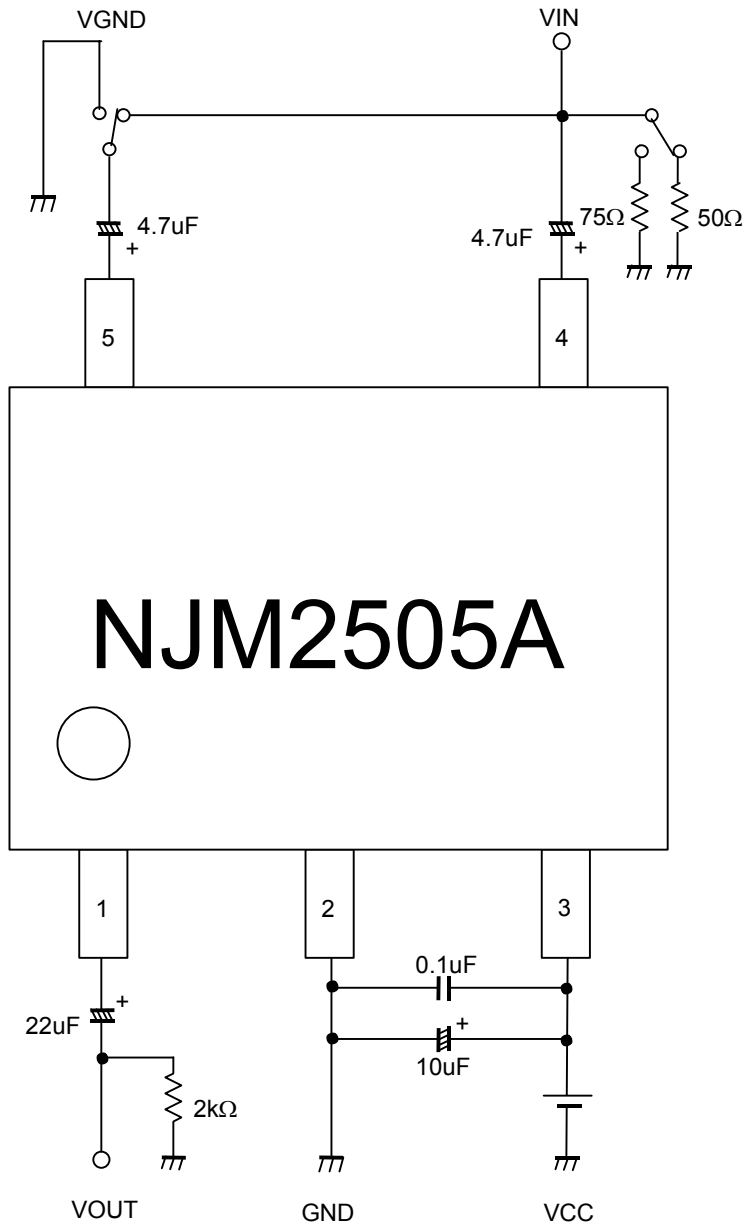

NJM2505A

■ APPLICATION CIRCUIT

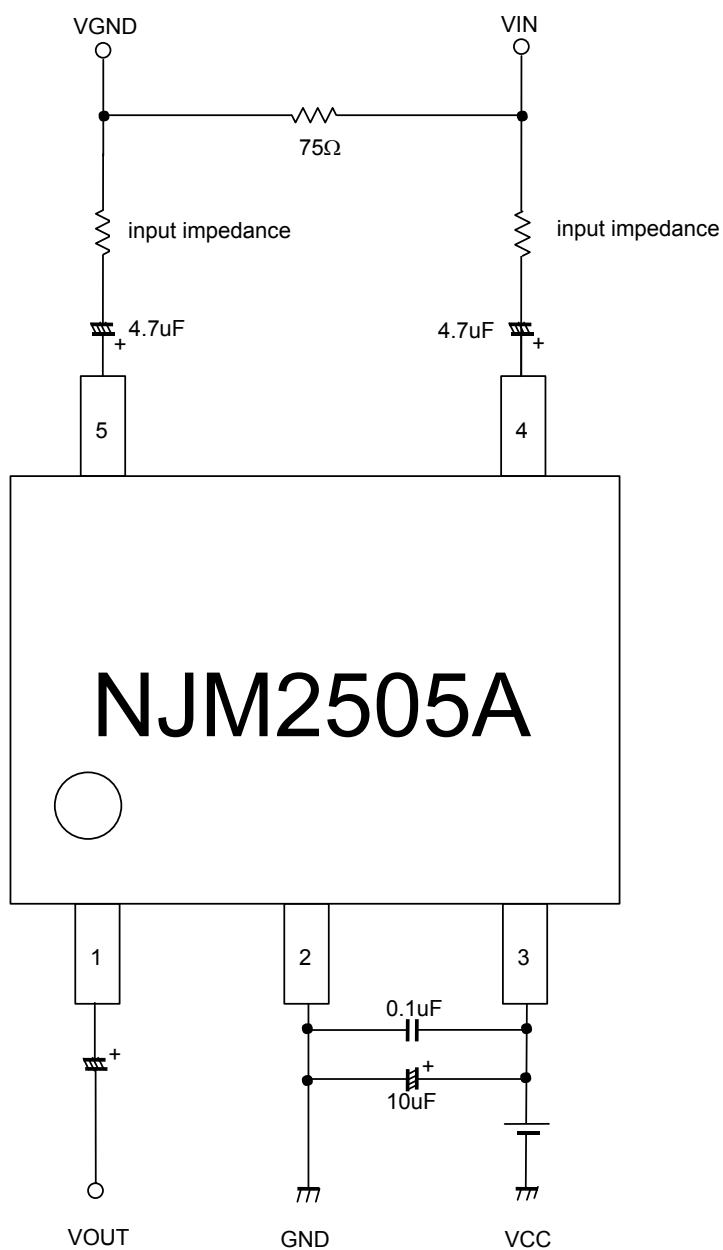

* NJM2505A don't built-in 75Ω driver circuit. This IC's load capability is than 2kΩ.
Please make adequate evaluation.

APPLICATION

1: Please connect input surge resistance to 4pin(Vin) and 5pin(VGND). Please refer to Fig. 1. If resistance is enlarged, a waveform may deteriorate.

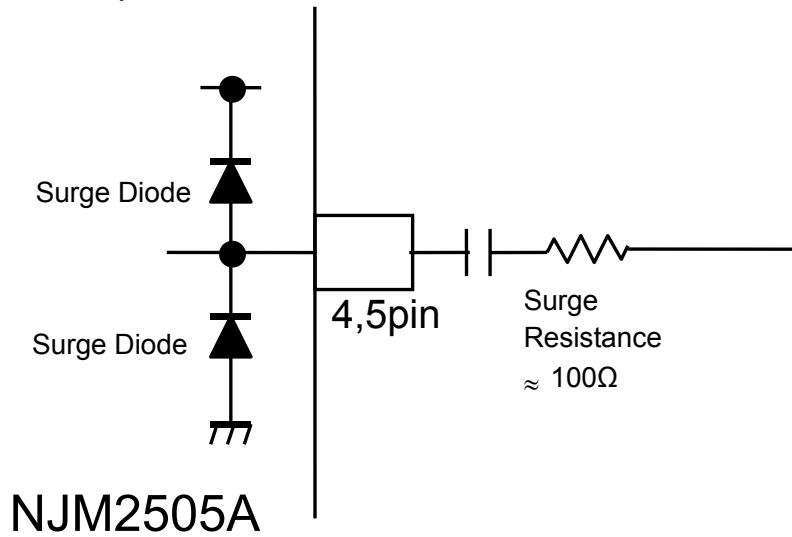

Fig1: External connection

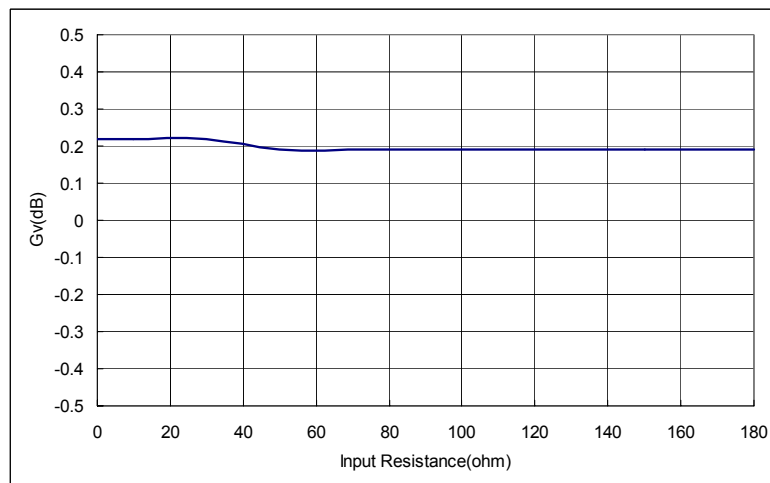

Fig2: Input resistance vs. Voltage gain

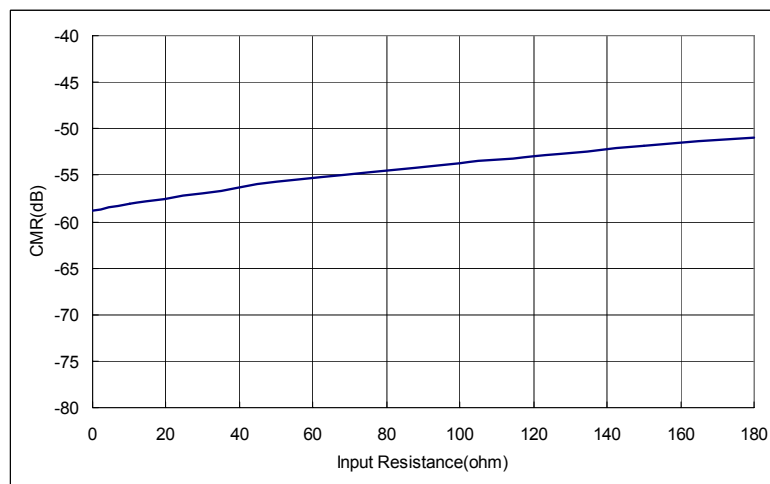

Fig3: Input resistance vs. Common mode rejection ratio

NJM2505A

2: Please connect a diode in a VGND at large common mode noise may be inputted into a Vin(4pin) and VGND(5pin). Thereby, large common noise is restricted(refer to Fig.4).Current flows to a diode. Be careful of current capacity.

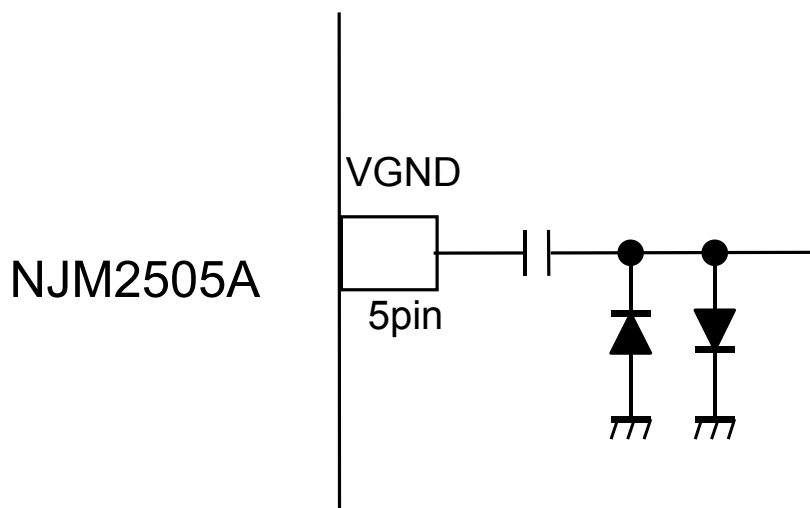

Fig4: External connection

■ EQUIVALENT CIRCUIT

Pin.No	Symbol	Inside Equivalent Circuit	Voitage
1	Vout		0.92V
2	GND	-	-
3	V ⁺	-	-
4	Vin		1.67V
5	VGND		1.67V

NJM2505A

■ TYPICAL CHARACTERISTICS

Voltage gain vs. Frequency
($V_{in}=100\text{kHz}$, 1.0Vp-p , $T_a=25^\circ\text{C}$)

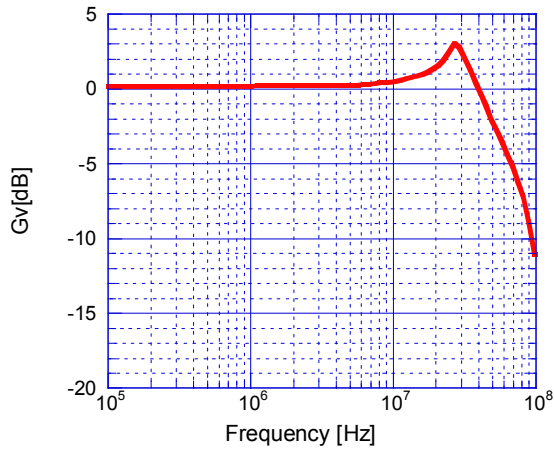

Common mode rejection ratio vs. Frequency
($V_{in}=1.0\text{Vp-p}$, $T_a=25^\circ\text{C}$)

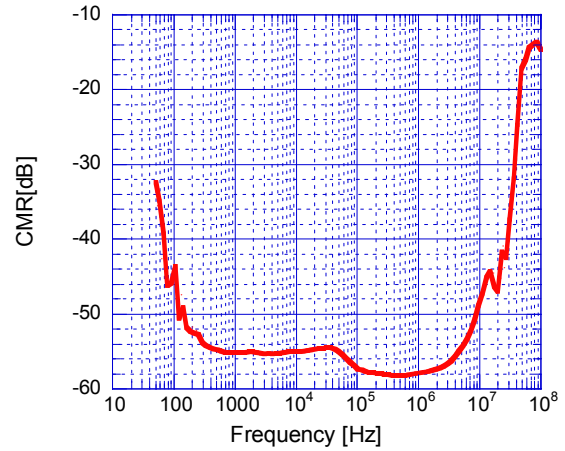

Supply current vs. Supply voltage
($T_a=25^\circ\text{C}$)

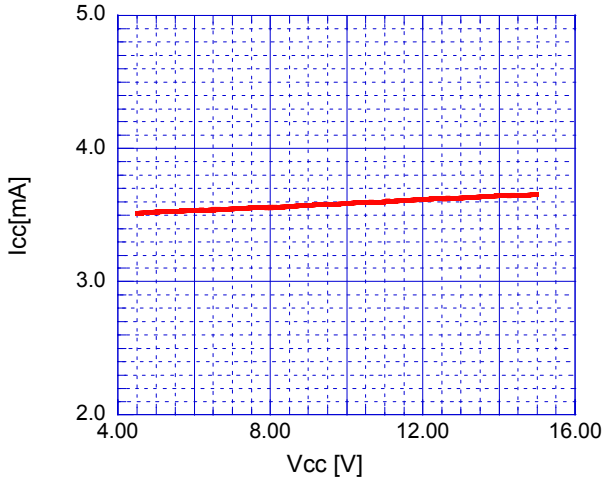

Maximum output voltage vs. Supply voltage
($V_{in}=100\text{kHz}$, $T_a=25^\circ\text{C}$)

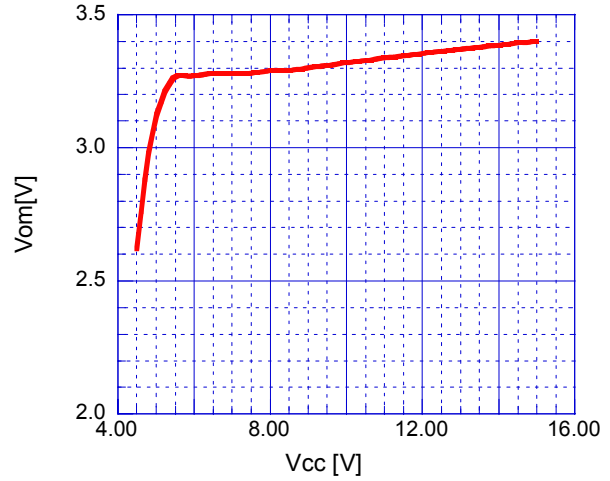

Voltage gain vs. Supply voltage
($V_{in}=100\text{kHz}$, 1.0Vpp , $T_a=25^\circ\text{C}$)

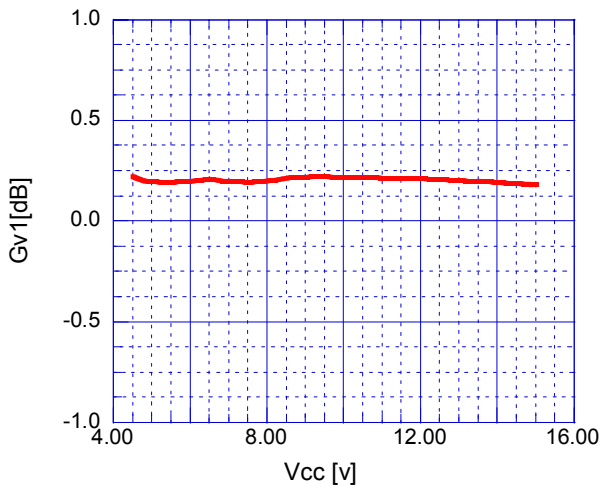

Frequency characteristics vs. Supply voltage
($V_{in}=1.0\text{Vpp}$, $10\text{MHz}/1\text{MHz}$, $T_a=25^\circ\text{C}$)

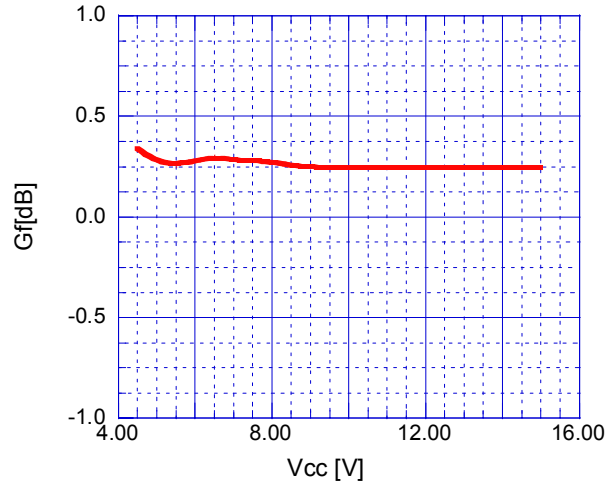

■ TYPICAL CHARACTERISTICS

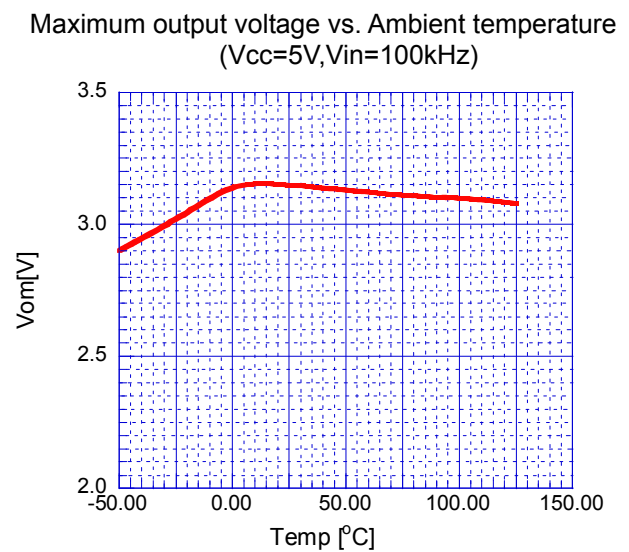
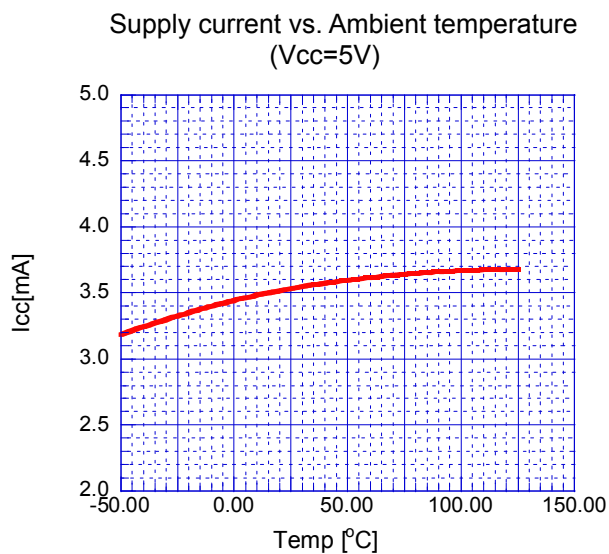
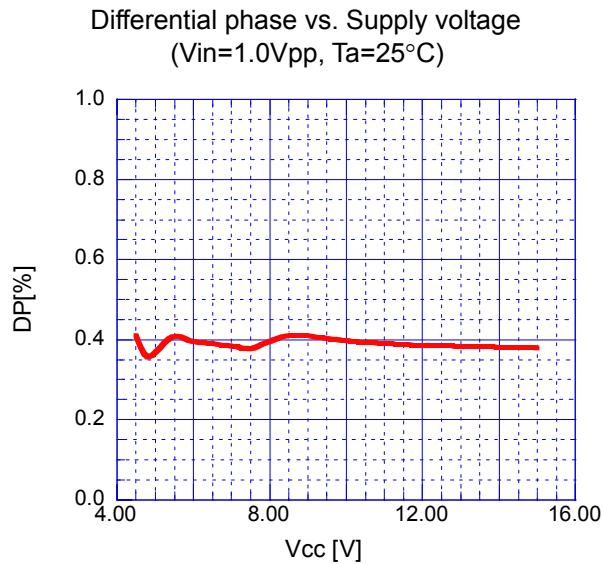
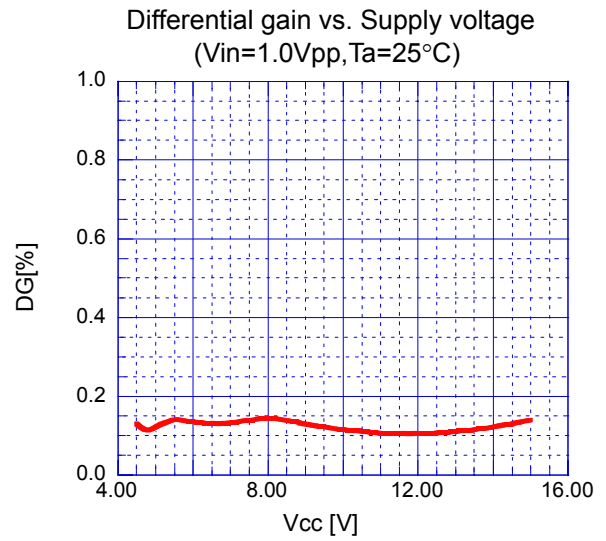
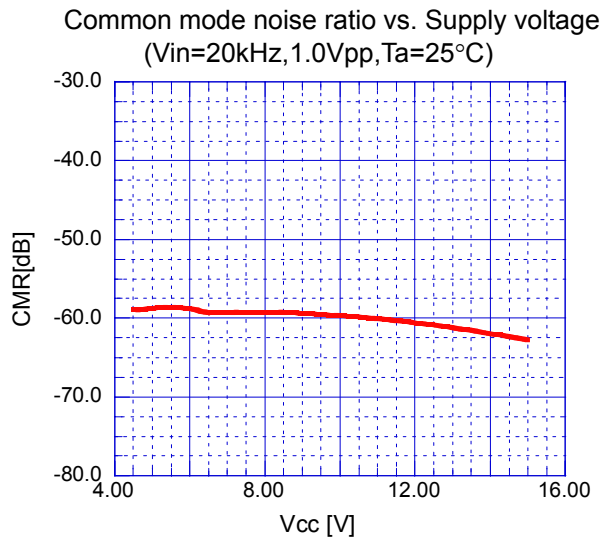

■ TYPICAL CHARACTERISTICS

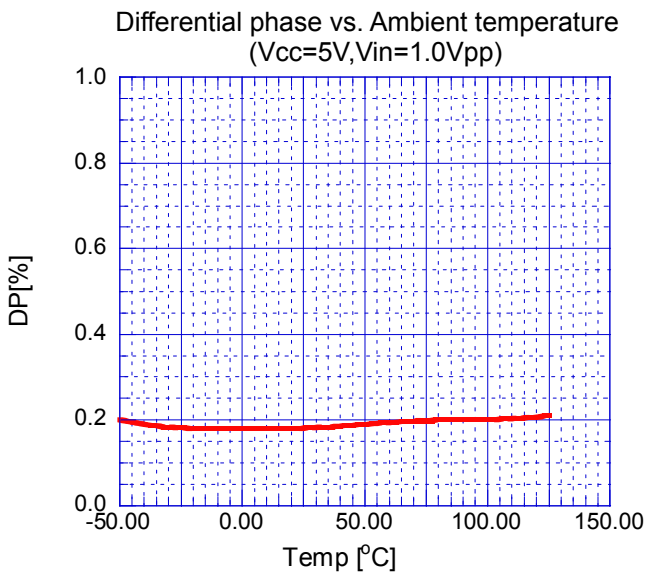
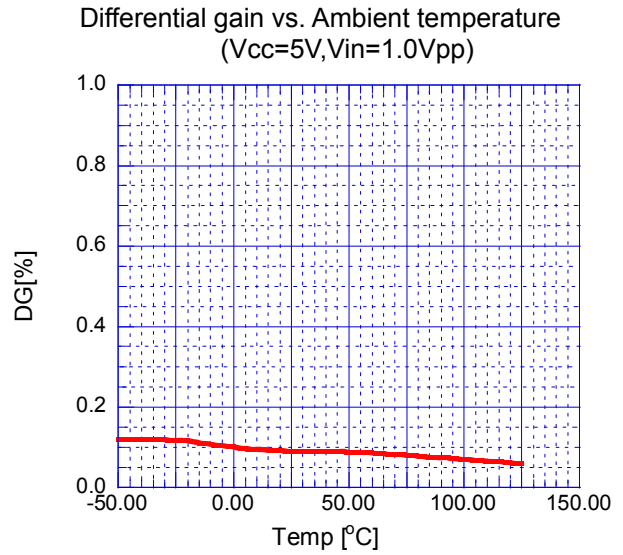
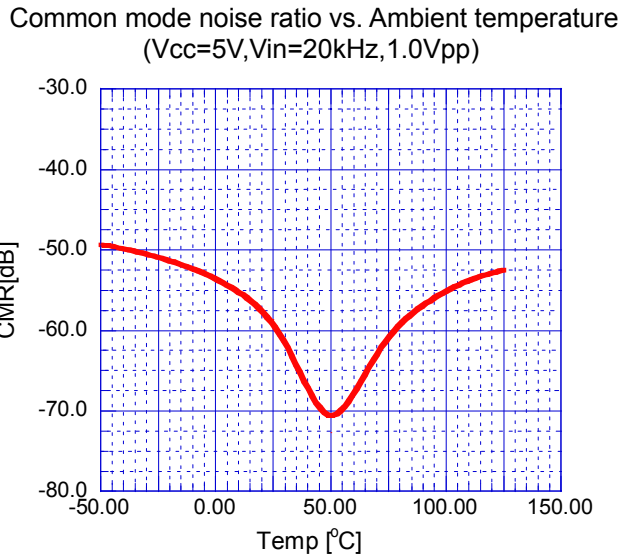
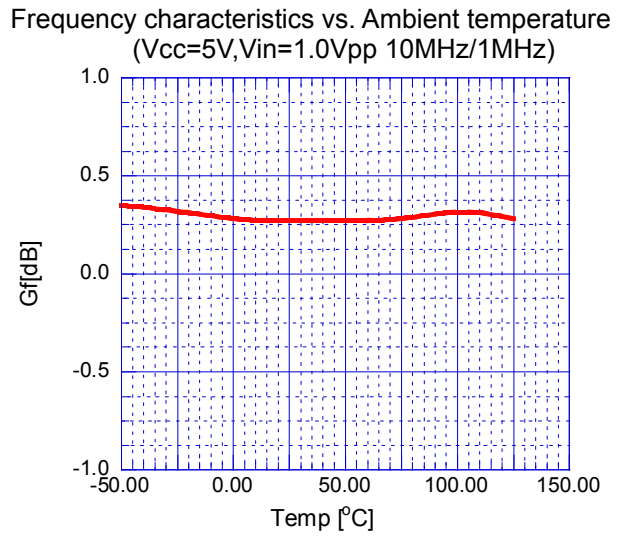
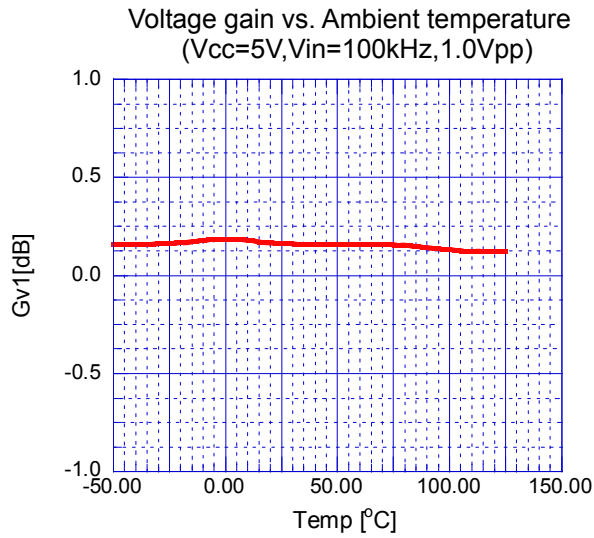

[CAUTION]
The specifications on this databook are only given for information, without any guarantee as regards either mistakes or omissions. The application circuits in this databook are described only to show representative usages of the product and not intended for the guarantee or permission of any right including the industrial rights.

Mouser Electronics

Authorized Distributor

Click to View Pricing, Inventory, Delivery & Lifecycle Information:

[NJR:](#)

[NJM2505AF-TE1](#) [NJM2505AF-TE2](#)

Данный компонент на территории Российской Федерации

Вы можете приобрести в компании MosChip.

Для оперативного оформления запроса Вам необходимо перейти по данной ссылке:

<http://moschip.ru/get-element>

Вы можете разместить у нас заказ для любого Вашего проекта, будь то серийное производство или разработка единичного прибора.

В нашем ассортименте представлены ведущие мировые производители активных и пассивных электронных компонентов.

Нашей специализацией является поставка электронной компонентной базы двойного назначения, продукции таких производителей как XILINX, Intel (ex.ALTERA), Vicor, Microchip, Texas Instruments, Analog Devices, Mini-Circuits, Amphenol, Glenair.

Сотрудничество с глобальными дистрибьюторами электронных компонентов, предоставляет возможность заказывать и получать с международных складов практически любой перечень компонентов в оптимальные для Вас сроки.

На всех этапах разработки и производства наши партнеры могут получить квалифицированную поддержку опытных инженеров.

Система менеджмента качества компании отвечает требованиям в соответствии с ГОСТ Р ИСО 9001, ГОСТ РВ 0015-002 и ЭС РД 009

Офис по работе с юридическими лицами:

105318, г.Москва, ул.Щербаковская д.3, офис 1107, 1118, ДЦ «Щербаковский»

Телефон: +7 495 668-12-70 (многоканальный)

Факс: +7 495 668-12-70 (доб.304)

E-mail: info@moschip.ru

Skype отдела продаж:

moschip.ru

moschip.ru_4

moschip.ru_6

moschip.ru_9