



Audio
CONNECTORS



Amphenol

ENTERTAINMENT INTERCONNECT CATALOGUE

Amphenol Australia Pty Ltd



Amphenol Australia Pty. Ltd.

Amphenol Australia's head office is based in Melbourne, Victoria and is the Sales, Marketing and Engineering centre of excellence for an extensive range of professional connector and cabling products. Satellite facilities of Amphenol Australia also exist in Colorado and Los Angeles, in the USA as well as Shenzhen, China.

Amphenol's global presence allows us to take full advantage of our numerous corporate resources and product portfolio to provide you with a vast offering and choice. Our extensive range is designed to meet the specific needs of the entertainment markets to make the selection of your interconnect partner an easy choice.

The Amphenol Audio international brand name was launched by Amphenol Australia in 2006 and represents the flag ship of one of the company's main core businesses and specialist product ranges. The company has been producing products for the pro-audio industry for over fifty years. Since the development of our XLR AC Series connectors, we have continued to provide our customers with exacting quality in an increasingly competitive environment.

Continuous improvement through ISO9001, a focus on environmental awareness and development of next generation industry leading products is our philosophy. As the entertainment industry moves into the future the emerging technologies from other industries has become more prevalent and more challenging. Amphenol Australia's global presence combined with its close technical relationships with other Amphenol sister divisions, each a specialist and leader in their own interconnect field, places it well to support innovation and meet this challenge head on.

The ability of Amphenol to provide a full range of design services required to support the customers applications design and modelling, applications engineering, fabrication, value-added assembly and testing, coupled with the largest interconnect offering on the market means that we can support all of your system level needs.

CONTENTS

| | PAGE | |
|---|---|----------------------|
|  | AX SERIES XLR CABLE CONNECTORS | 3 |
| | METAL SHELL TYPE - SOLDER | 4 |
|  | AC SERIES XLR CABLE CONNECTORS | 10 |
| | METAL SHELL TYPE - SOLDER | 11 |
| | THERMOPLASTIC SHELL TYPE - SOLDER | 15 |
|  | AC "Z" SERIES XLR METAL CHASSIS MOUNT CONNECTORS | 18 |
| | METAL D TYPE FLANGE - SOLDER AND PCB | 19 |
| | METAL P TYPE FLANGE - SOLDER AND PCB | 22 |
|  | AC SERIES XLR PCB CHASSIS MOUNT CONNECTORS | 28 |
| | THERMOPLASTIC A - TYPE FLANGE 3 CONTACT | 29 |
| | METAL B - TYPE FLANGE 3 CONTACT | 32 |
| | THERMOPLASTIC A - TYPE FLANGE 5 CONTACT | 36 |
|  | AC SERIES DUAL 1/4" (6.35mm) / XLR | 43 |
| | C - TYPE LOW PROFILE DUAL JACK / XLR CONNECTORS | NEW ITEMS 44 |
| | C - TYPE DUAL JACK / XLR CONNECTORS | 46 |
|  | SP/HP/EP/AP SERIES HIGH POWER / LOUDSPEAKER CONNECTORS | 52 |
| | SP SERIES LOUDSPEAKER CONNECTORS | 53 |
| | HP POWER CONNECTORS | NEW ITEMS 62 |
| | EP METAL TYPE - SOLDER | 64 |
| | AP THERMOPLASTIC TYPE - SOLDER | 66 |
|  | XLRnet SERIES | 70 |
| | RJ45 CABLE PLUG HOUSING | 70 |
| | RJ45 PCB CHASSIS MOUNT CONNECTORS | NEW ITEMS 73 |
|  | BNC 75Ω RF CONNECTORS | 81 |
| | BNC 75Ω RF CONNECTORS | 82 |
| | BNC PATCH PANELS | 84 |
|  | 1/4" PHONE CONNECTORS | 87 |
| | T-SERIES | 89 |
| | T-SERIES SWITCHPLUG | 91 |
| | MUSICIAN SERIES II | 96 |
|  | 1/4" PHONE JACK CONNECTORS | 101 |
|  | PLUGS AND SOCKETS | 111 |
| | 3.5mm K-SERIES | 112 |
| | RCA SERIES | 115 |
| | G-TYPE MINIATURE XLR | 118 |
|  | MULTIPIN CONNECTORS | 122 |
| | MP-41 SERIES | 123 |
| | MP-62/MP-65 SERIES | 128 |
| | ACCESSORIES | NEW ITEMS 132 |
| | CONNECTOR WIRING INFORMATION | 135 |
| | INDEX | 137 |



ISO VIEW OF AX SERIES XLR CABLE CONNECTOR

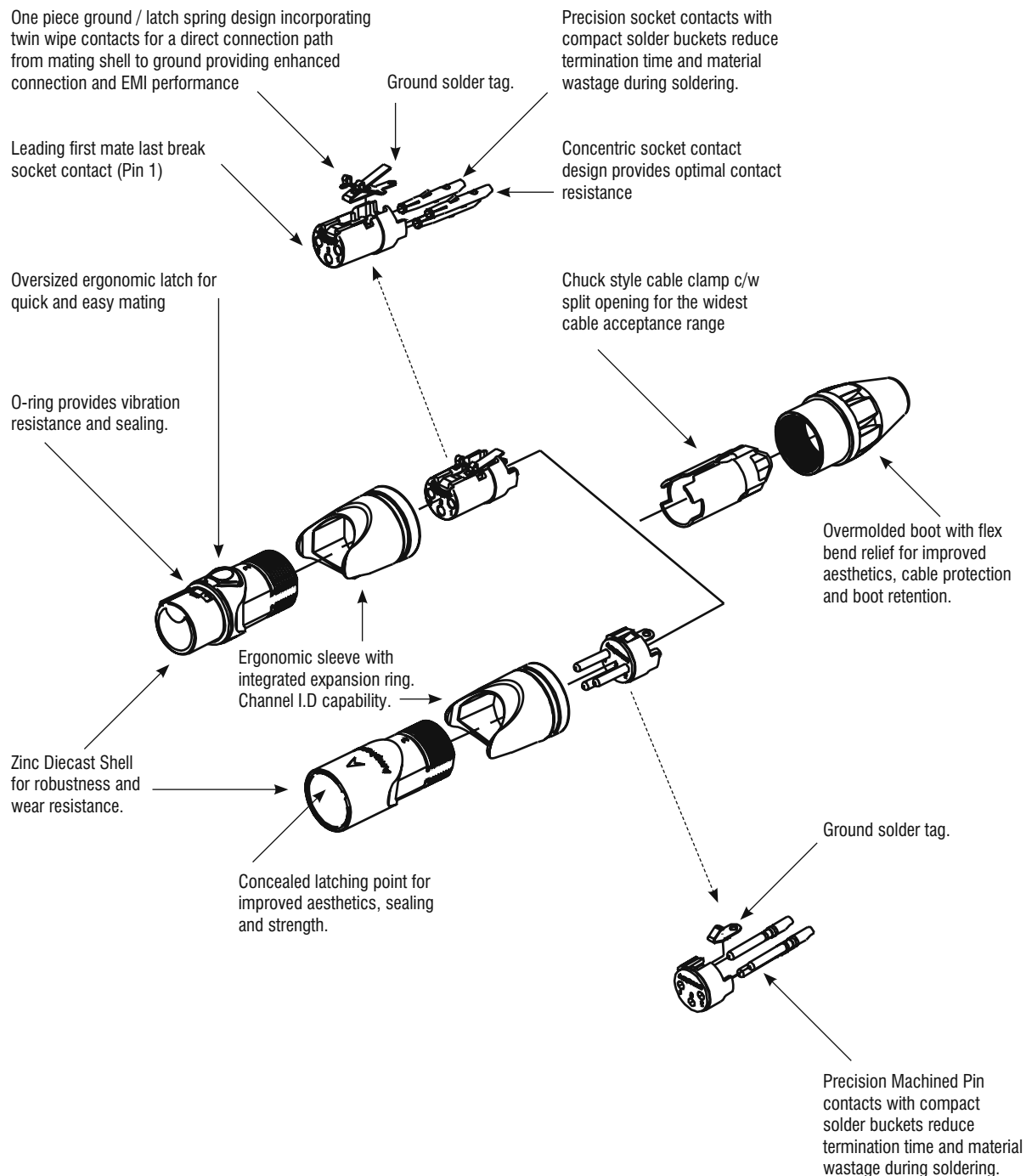



AX SERIES XLR CABLE CONNECTORS

The revolutionary AX series of XLR connectors introduce an exciting contemporary look and feel to the professional audio interconnect market. They are designed to complement modern audio architecture and truly "fit" within their environment. An impressive list of features guarantees pure sound performance in the most demanding applications providing unrivalled value.

Features

- Unique Australian designed shell and housing.
- One piece ground / latch spring design incorporating twin wipe contacts for a direct connection path from mating shell to ground providing enhanced connection and EMI performance.
- Ergonomic sleeve design for improved grip.
- Channel I.D capability with coloured sleeves.
- Oversized ergonomic latch for quick and easy mating.
- Leading first mate last break pin 1 on socket connectors.
- Chuck style cable clamp to suit 3mm - 8mm (0.118" - 0.314") cable O.D. with integrated split to allow inclusion after soldering.
- Concealed latching point for improved aesthetics, sealing and strength.
- Overmolded boot with flex bend relief for improved aesthetics, cable protection and boot retention.
- Concentric socket contact design provides optimal contact resistance
- Precision machined pin contacts as standard.
- Compact solder buckets to reduce termination time and material wastage during the soldering process.
- Zinc diecast shell housing for robustness and wear with Satin nickel or Black finish.
- Available in 3,4 and 5 contact arrangements.

Options

- Coloured I.D sleeves.
- Satin nickel or Black shell finish.
- Single or Bulk packaging.
- Gold plated contacts.

Ordering Codes

We have listed the more common ordering codes in each section. For further options please refer to the part number breakdown charts. Please contact us if you need any further assistance.

Simple steps to guide you in using this catalogue

- 1) Identify the product group listed in Contents on page 1 and go directly to that page number.
- 2) Each product group cover page then details information and options available.
- 3) Refer to the product detail pages and identify the product you require pictorially.
- 4) Read the product description column for the products standard features.
- 5) Use variations column to determine your choice.
- 6) Identify part number.
- 7) In the event the particular option you require is not listed please refer to the part number breakdown page at the end of each section.
- 8) Please contact us directly if you have any further problems.



Features:

- Unique Australian designed shell and housing.
- Ergonomic stylish sleeve design for improved grip.
- Oversized latch lever preserves your thumb.
- Leading first mate last break pin 1 on socket connectors.
- Chuck style cable clamp to suit 3mm - 8mm (0.118" - 0.314") cable O.D. with integrated split to allow inclusion after soldering.
- Overmolded cable support boot.
- New socket contact design for improved contact resistance.
- Precision machined pin contacts as standard.
- Compact solder buckets to reduce soldering time and wastage.
- Zinc diecast shell housing with Satin nickel or Matt black finish.
- Available in 3,4 and 5 contact arrangements.

Options:

- Coloured I.D sleeves.
- Satin nickel or Matt black shell finish.
- Single or Bulk packaging.

Part Number Breakdown: Page 6

Specifications: Page 9

Assembly Instructions: Page 7 & 8

| PRODUCT - FIGURE | DRAWING Dimensions in mm (inches) | DESCRIPTION | VARIATIONS | PART NUMBER |
|------------------|--------------------------------------|--|----------------------------------|-----------------|
| | | XLR 3 pole male Machined contacts Nickel Finish | Standard Gold Plated Contacts | AX3M AX3M-AU |
| | | XLR 3 pole male Machined contacts Black Finish | Bulk Pack | AX3M BULK |
| | | XLR 3 pole female Stamped contacts Nickel Finish | Standard Gold Plated Contacts | AX3F AX3F-AU |
| | | XLR 3 pole female Stamped contacts Black Finish | Bulk Pack | AX3F BULK |
| | | XLR 4 pole male Machined contacts Nickel Finish | Standard Gold Plated Contacts | AX4M AX4M-AU |
| | | XLR 4 pole male Machined contacts Black Finish | Bulk Pack | AX4M BULK |

*PI538 is available for download at www.amphenolaudio.com



| PRODUCT - FIGURE | DRAWING Dimensions in mm (inches) | DESCRIPTION | VARIATIONS | PART NUMBER |
|------------------|--------------------------------------|---|----------------------|-------------|
| | | XLR 4 pole male Machined contacts Black Finish | Standard | AX4MB |
| | | | Gold Plated Contacts | AX4MB-AU |
| | | | Bulk Pack | AX4MB BULK |
| | | XLR 4 pole female Machined contacts Nickel Finish | Standard | AX4F |
| | | | Gold Plated Contacts | AX4F-AU |
| | | | Bulk Pack | AX4F BULK |
| | | XLR 4 pole female Machined contacts Black Finish | Standard | AX4FB |
| | | | Gold Plated Contacts | AX4FB-AU |
| | | | Bulk Pack | AX4FB BULK |
| | | XLR 5 pole male Machined contacts Nickel Finish | Standard | AX5M |
| | | | Gold Plated Contacts | AX5M-AU |
| | | | Bulk Pack | AX5M BULK |
| | | XLR 5 pole male Machined contacts Black Finish | Standard | AX5MB |
| | | | Gold Plated Contacts | AX5MB-AU |
| | | | Bulk Pack | AX5MB BULK |
| | | XLR 5 pole female Machined contacts Nickel Finish | Standard | AX5F |
| | | | Gold Plated Contacts | AX5F-AU |
| | | | Bulk Pack | AX5F BULK |
| | | XLR 5 pole female Machined contacts Black Finish | Standard | AX5FB |
| | | | Gold Plated Contacts | AX5FB-AU |
| | | | Bulk Pack | AX5FB BULK |



PART NUMBER BREAKDOWN

METAL SHELL TYPE - SOLDER

E. G. **AX3MB2-AU BULK**
AX (Series Prefix), **3** contacts, **M**ale, **B**lack Finish,
2 (Red Sleeve)- **AU** (Gold Plated Contacts), **BULK** Packaged.

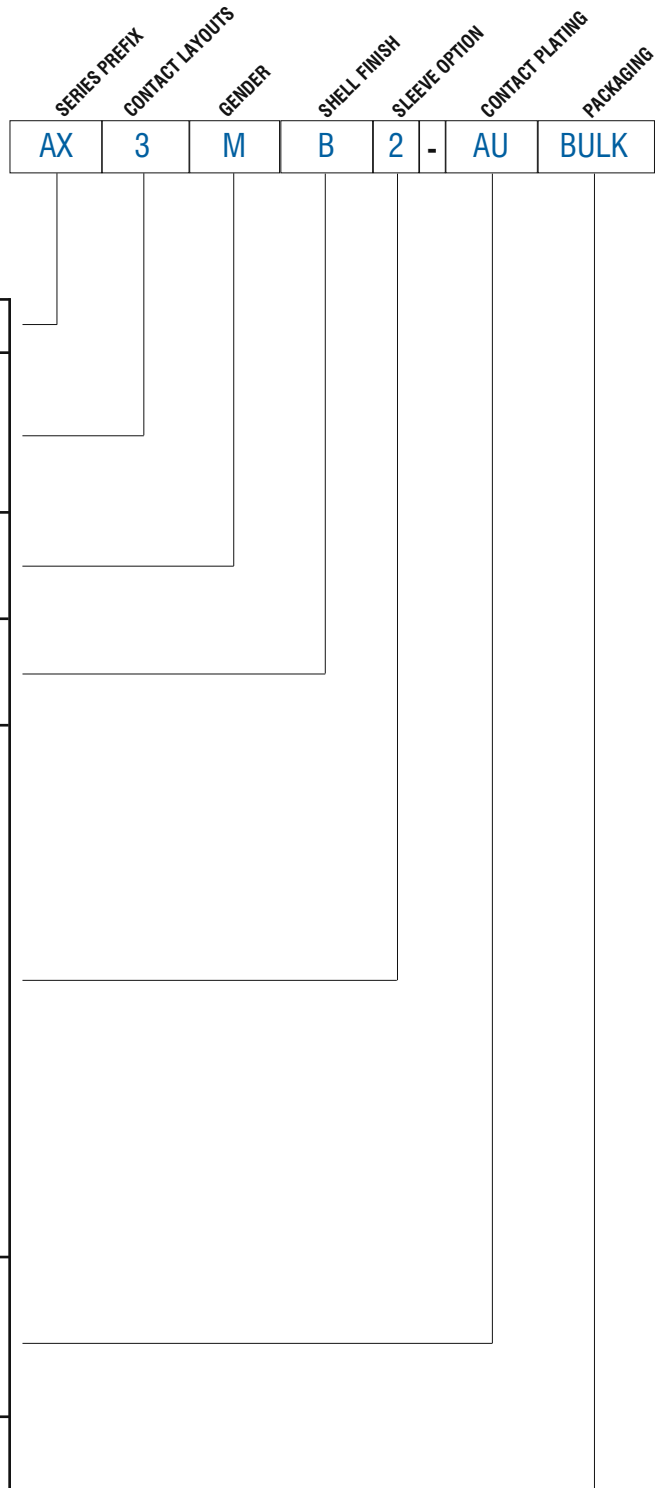

| | | | |
|------------------------|-------|---|---|
| SERIES PREFIX | AX | = | Series Prefix |
| CONTACT LAYOUTS | 3 | = | 3 Contacts |
| | 4 | = | 4 Contacts |
| | 5 | = | 5 Contacts |
| GENDER | F | = | Female Socket Contacts |
| | M | = | Male Pin Contacts |
| SHELL FINISH | Blank | = | Nickel Plated Finish |
| | B | = | Black Finish |
| SLEEVE OPTION | 1 | = | Brown |
| | 2 | = | Red |
| | 3 | = | Orange |
| | 4 | = | Yellow |
| | 5 | = | Green |
| | 6 | = | Blue |
| | 7 | = | Violet |
| | 8 | = | Grey |
| | 9 | = | White |
| CONTACT PLATING | Blank | = | Standard Plating (Silver or Tin - Refer to Standard Data.) |
| | AU | = | Gold Plated |
| PACKAGING | Blank | = | Individual Bags |
| | BULK | = | Bulk Packed |



PI539 ASSEMBLY INSTRUCTIONS

AX SERIES FEMALE XLR
CABLE CONNECTOR

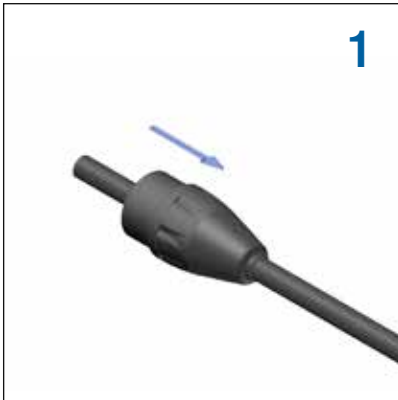

Slide the nut (Backshell) onto the cable

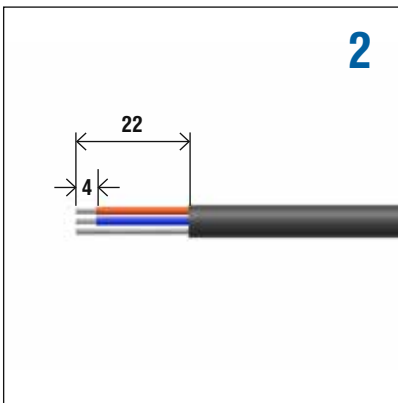

Strip the cable

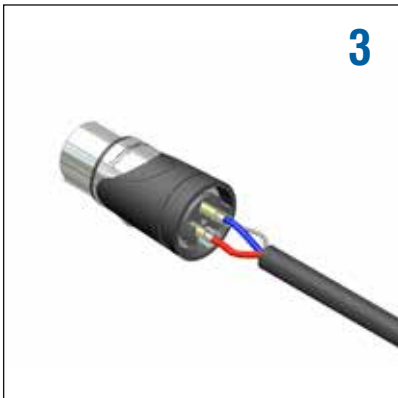

Push back the insert only enough to expose the solder buckets. It is not necessary to remove the insert. Solder the wires to the contacts.



Install the cable clamp, flush to the insert making sure to align the top slot with the spring. Then push the insert & cable clamp together into the shell.



Thread the nut (Backshell) onto the shell (Torque 0.8Nm - 1.2Nm) to activate the cable clamp and close the connector assembly.

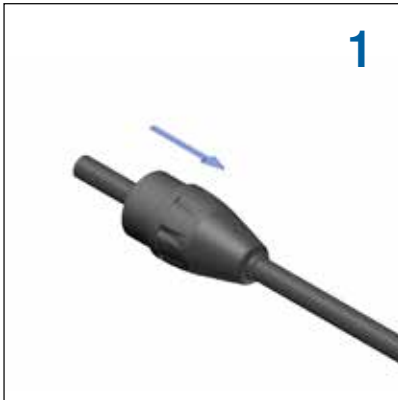

1

Slide the nut (Backshell) onto the cable

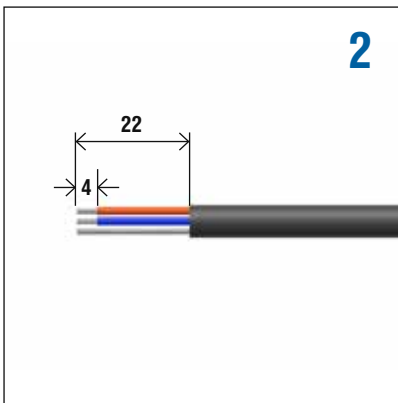

2

Strip the cable

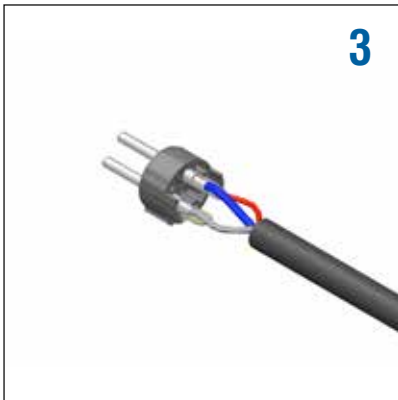

3

Solder the wires to the contacts.



4

Install the cable clamp flush to the insert making sure to align the slot with the ground contact.



5

Align the key of the insert with the keyway on the shell then push the pin insert & cable clamp together in the shell.

PI538 ASSEMBLY INSTRUCTIONS

AX SERIES MALE XLR
CABLE CONNECTOR



6

Thread the nut (Backshell) onto the shell (Torque 0.8Nm - 1.2Nm) to activate the cable clamp and close the connector assembly.

STANDARD DATA AX SERIES CABLE CONNECTORS

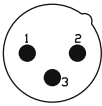
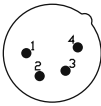
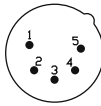

| | | VALUE | | |
|-----------------------------------|--|---|---|---|
| GENERAL CHARACTERISTICS | Number of contacts | 3 | 4 | 5 |
| | AX Series Contact Arrangements (Front view of pin inserts) |  |  |  |
| | Termination | SOLDER | | |
| | Max. Wire Gauge - Stranded wire: Solder | 14AWG | 16AWG | 18AWG |
| | Flammability rating of insulator plastics and housings | UL94V-0 | | |
| | Environmental | Complies with EU RoHS 2 Directive 2011/65/EU | | |
| ELECTRICAL CHARACTERISTICS | Service Voltage RMS | 133V ¹⁾ | | |
| | Test Voltage AC RMS | 1400V | | |
| | Current carrying capacity: Solder | 15A | 10A | 7.5A |
| | Typical Contact Resistance | ≤3m Ω | | |
| | Insulation Resistance | ≥1G Ω | | |
| CLIMATIC CHARACTERISTICS | Protection Class | IP40 | | |
| | Operating Temperature | -25 °C to +75 °C (-13°F to +167°F) | | |
| MECHANICAL CHARACTERISTICS | Insertion and Withdrawal force | ≥10N - ≤30N | | |
| | Weight ²⁾ | 31g (0.068lb) | 33g (0.073lb) | 33g (0.073lb) |
| | Typical Cable retention force | 22Kg to 44Kg (50lb to 100lb) - Dependent on cable material and diameter. | | |
| | Cable O.D. range | 3mm to 8mm (0.118" to 0.314") | | |
| | Mechanical Operations | 1000 mating cycles | | |
| MATERIALS | Connector shell - Metal Shell finish | Diecast Zinc Alloy Satin nickel or Black | | |
| | Insulators | UL94V-0 PA66, 30% Glass Filled | | |
| | Boot / Backshell Finish | UL94V-0 Noryl N190 / Santoprene Black, other colours available - see page 80 | | |
| | Cable clamp | Noryl N190 | | |
| | Sleeve | Noryl N190 | | |
| | Male Contact Machined - Solder / Plating | Brass / Silver or Gold (Optional) | | |
| | Female Contact Stamped - Solder / Plating | Phosphor Bronze / Tin or Gold (Optional) | | |

Rev 3 - 03/2013

¹⁾ Not suitable for domestic applications above 50V

²⁾ Approximate weight only, does not include packaging. Please contact us for exact weight for shipping purposes.

Amphenol



AC SERIES XLR CABLE CONNECTORS

Amphenol Australia have been manufacturing and designing innovative XLR connectors since 1955. The AC series cable connector range complies with IEC268-12 and AES 14-1992 standards.
CSA File Number 68598.

Features

- AC series XLR connectors feature the unique Australian design and patented "Jaws" cable retention system
- A leading first mate last break socket contact is standard on all female connectors (Pin 1).
- The "Jaws" cable retention system provides up to 44kg (100lb) of strain.
- The AC series connector can be quickly and easily assembled without screws – by hand or portable termination tool. (Part number T2860)
- Available in 3, 4, 5, 6A and 7 contact arrangements.
- Compatible with all other XLR brands.

Options

- Solder Bucket termination
- Thermoplastic shell
- Zinc Diecast shell - Satin Nickel Finish
- Zinc Diecast shell - Black Polyester Finish
- Gold, Silver or Tin Plated contacts
- Bulk Style Packaging
- Single Bag packs
- Precision machined contacts
- Cost effective stamped contacts on 3 pole
- Standard Jaws cable clamp, Cable O.D 3mm to 6.5mm (0.118" to 0.255")
- Large Jaws cable clamp, Cable O.D 6.5mm to 8mm (0.255" to 0.314")
- Metal Boots / Backshells
- Coloured Boots / Backshells
- Coloured Identification rings
- Termination / Assembly tooling

Jaws Cable Clamp Options



Standard Jaws cable clamp (Black), Cable O.D 3mm to 6.5mm (0.118" to 0.255")



Large Jaws cable clamp (Purple), Cable O.D 6.5mm to 8mm (0.255" to 0.314")

Ordering Codes

We have listed the more common ordering codes in each section. For further options please refer to the part number breakdown charts. Please contact us if you need any further assistance.

Simple steps to guide you in using this catalogue

- 1) Identify the product group listed in Contents on page 1 and go directly to that page number.
- 2) Each product group cover page then details information and options available.
- 3) Refer to the product detail pages and identify the product you require pictorially.
- 4) Read the product description column for the products standard features.
- 5) Use variations column to determine your choice.
- 6) Identify part number.
- 7) In the event the particular option you require is not listed please refer to the part number breakdown page at the end of each section.
- 8) Please contact us directly if you have any further problems.



Features:







- Zinc Diecast Shell.
- Solder Bucket connections.
- "Jaws" Cable Retention System.
- Contact layouts in 3, 4, 5, 6A and 7.
- Precision machined or Stamped contacts.
- Leading first mate last break socket contact.
- Quick and easy assembly without screws – by hand or portable termination tool. (Part number T2860.)







Options: Stamped Contacts (3 contact only), Gold plated contacts, Large or Small Jaws Cable Clamp, Black Finish Shell, Bulk Pack, Coloured Boots / Backshells

Part Number Breakdown: Page 14

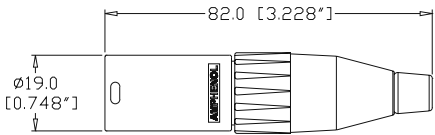

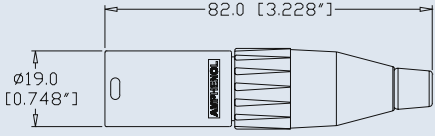



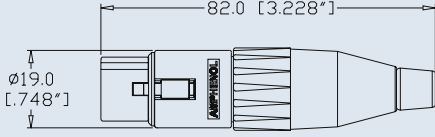







Specifications: Page 16

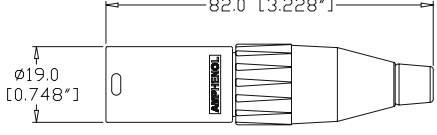

| PRODUCT - FIGURE | DRAWING | DESCRIPTION | VARIATIONS | PART NUMBER |
|---|---------|--|----------------------|-------------|
|  | | XLR 3 pole male, Machined contacts, Nickel Finish, Jaws cable clamp | Standard | AC3MM |
| | | | Gold Plated Contacts | AC3MM-AU |
| | | | Large Cable Clamp | AC3MMJ |
| | | | Bulk Pack | AC3MM BULK |
|  | | XLR 3 pole male, Machined contacts, Black Finish, Jaws cable clamp | Standard | AC3MMB |
| | | | Gold Plated Contacts | AC3MMB-AU |
| | | | Large Cable Clamp | AC3MMBJ |
| | | | Bulk Pack | AC3MMB BULK |
|  | | XLR 3 pole male, Stamped contacts, Nickel Finish, Jaws cable clamp | Standard | AC3M |
| | | | Gold Plated Contacts | AC3M-AU |
| | | | Large Cable Clamp | AC3MJ |
| | | | Bulk Pack | AC3M BULK |
|  | | XLR 3 pole male, Stamped contacts, Black Finish, Jaws cable clamp | Standard | AC3MB |
| | | | Gold Plated Contacts | AC3MB-AU |
| | | | Large Cable Clamp | AC3MBJ |
| | | | Bulk Pack | AC3MB BULK |
|  | | XLR 3 pole female, Stamped contacts, Nickel Finish, Jaws cable clamp | Standard | AC3F |
| | | | Gold Plated Contacts | AC3F-AU |
| | | | Large Cable Clamp | AC3FJ |
| | | | Bulk Pack | AC3F BULK |
|  | | XLR 3 pole female, Stamped contacts, Black Finish, Jaws cable clamp | Standard | AC3FB |
| | | | Gold Plated Contacts | AC3FB-AU |
| | | | Large Cable Clamp | AC3FBJ |
| | | | Bulk Pack | AC3FB BULK |

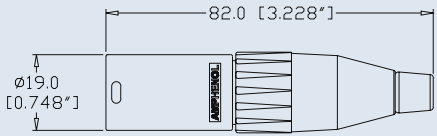
| PRODUCT - FIGURE | DRAWING Dimensions in mm (inches) | DESCRIPTION | VARIATIONS | PART NUMBER |
|---|--------------------------------------|--|----------------------|-------------|
|  | | XLR 4 pole male, Machined contacts, Nickel Finish, Jaws cable clamp | Standard | AC4M |
| | | | Gold Plated Contacts | AC4M-AU |
| | | | Large Cable Clamp | AC4MJ |
| | | | Bulk Pack | AC4M BULK |
|  | | XLR 4 pole male, Machined contacts, Black Finish, Jaws cable clamp | Standard | AC4MB |
| | | | Gold Plated Contacts | AC4MB-AU |
| | | | Large Cable Clamp | AC4MBJ |
| | | | Bulk Pack | AC4MB BULK |
|  | | XLR 4 pole female, Machined contacts, Nickel Finish, Jaws cable clamp | Standard | AC4F |
| | | | Gold Plated Contacts | AC4F-AU |
| | | | Large Cable Clamp | AC4FJ |
| | | | Bulk Pack | AC4F BULK |
|  | | XLR 4 pole female, Machined contacts, Black Finish, Jaws cable clamp | Standard | AC4FB |
| | | | Gold Plated Contacts | AC4FB-AU |
| | | | Large Cable Clamp | AC4FBJ |
| | | | Bulk Pack | AC4FB BULK |
|  | | XLR 5 pole male, Machined contacts, Nickel Finish, Jaws cable clamp | Standard | AC5M |
| | | | Gold Plated Contacts | AC5M-AU |
| | | | Large Cable Clamp | AC5MJ |
| | | | Bulk Pack | AC5M BULK |
|  | | XLR 5 pole male, Machined contacts, Black Finish, Jaws cable clamp | Standard | AC5MB |
| | | | Gold Plated Contacts | AC5MB-AU |
| | | | Large Cable Clamp | AC5MBJ |
| | | | Bulk Pack | AC5MB BULK |
|  | | XLR 5 pole female, Machined contacts, Nickel Finish, Jaws cable clamp | Standard | AC5F |
| | | | Gold Plated Contacts | AC5F-AU |
| | | | Large Cable Clamp | AC5FJ |
| | | | Bulk Pack | AC5F BULK |
|  | | XLR 5 pole female, Machined contacts, Black Finish, Jaws cable clamp | Standard | AC5FB |
| | | | Gold Plated Contacts | AC5FB-AU |
| | | | Large Cable Clamp | AC5FBJ |
| | | | Bulk Pack | AC5FB BULK |

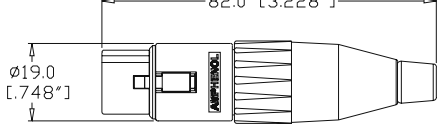

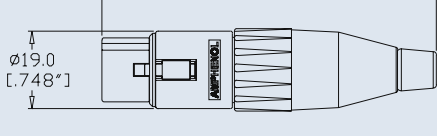
| PRODUCT - FIGURE | DRAWING Dimensions in mm (inches) | DESCRIPTION | VARIATIONS | PART NUMBER |
|---|---|---|----------------------|-------------|
|  |  | XLR 6A pole male, Machined contacts, Nickel Finish, Jaws cable clamp | Standard | AC6AM |
| | | | Gold Plated Contacts | AC6AM-AU |
| | | | Large Cable Clamp | AC6AMJ |
| | | | Bulk Pack | AC6AM BULK |
|  |  | XLR 6A pole male, Machined contacts, Black Finish, Jaws cable clamp | Standard | AC6AMB |
| | | | Gold Plated Contacts | AC6AMB-AU |
| | | | Large Cable Clamp | AC6AMBJ |
| | | | Bulk Pack | AC6AMB BULK |
|  |  | XLR 6A pole female, Machined contacts, Nickel Finish, Jaws cable clamp | Standard | AC6AF |
| | | | Gold Plated Contacts | AC6AF-AU |
| | | | Large Cable Clamp | AC6AFJ |
| | | | Bulk Pack | AC6AF BULK |
|  |  | XLR 6A pole female, Machined contacts, Black Finish, Jaws cable clamp | Standard | AC6AFB |
| | | | Gold Plated Contacts | AC6AFB-AU |
| | | | Large Cable Clamp | AC6AFBJ |
| | | | Bulk Pack | AC6AFB BULK |
|  |  | XLR 7 pole male, Gold plated Machined contacts, Nickel Finish, Jaws cable clamp | Standard | AC7M |
| | | | Large Cable Clamp | AC7MJ |
| | | | Bulk Pack | AC7M BULK |
|  |  | XLR 7 pole male, Gold plated Machined contacts, Black Finish, Jaws cable clamp | Standard | AC7MB |
| | | | Large Cable Clamp | AC7MBJ |
| | | | Bulk Pack | AC7MB BULK |
|  |  | XLR 7 pole female, Gold plated Machined contacts, Nickel Finish, Jaws cable clamp | Standard | AC7F |
| | | | Large Cable Clamp | AC7FJ |
| | | | Bulk Pack | AC7F BULK |
|  |  | XLR 7 pole female, Gold plated Machined contacts, Black Finish, Jaws cable clamp | Standard | AC7FB |
| | | | Large Cable Clamp | AC7FBJ |
| | | | Bulk Pack | AC7FB BULK |

PART NUMBER BREAKDOWN

METAL SHELL TYPE - SOLDER

E. G. **AC3MMBJ-AU BULK**

AC (Series Prefix), **3** contacts, **Male**, **Machined Contacts**, **Black Polyester Finish**, **J** (Large Jaws), - **AU** (Gold Plated Contacts), **Bulk** Packaged.

SERIES PREFIX CONTACT LAYOUTS GENDER CONTACT SHELL FINISH CABLE CLAMP CONTACT PLATING PACKAGING

AC **3** **M** **M** **B** **J** **-** **AU** **BULK**

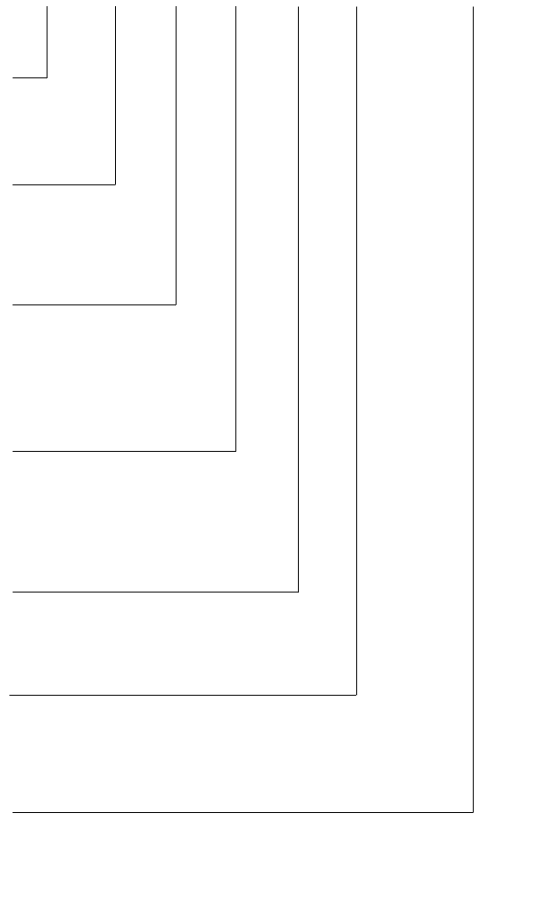

| | |
|------------------------------------|---|
| SERIES PREFIX | AC = Series Prefix |
| CONTACT LAYOUTS | 3 = 3 Contacts 4 = 4 Contacts 5 = 5 Contacts 6A = 6 Contacts 7 = 7 Contacts |
| GENDER | F = Female Socket Contacts M = Male Pin Contacts |
| CONTACT¹ | Blank = Stamped Contacts M = Machined Contacts G = Stamped Contacts, Ground Tag MG = Machined Contacts, Ground Tag (Applicable 3 male pin contacts, option M & MG only) |
| SHELL FINISH² | Blank = Nickel Plated Finish B = Black Polyester Finish |
| CABLE CLAMP | Blank = Standard Jaws 3mm - 6.5mm cable O.D. (0.118" to 0.255") J = Large Jaws 6.5mm - 8mm cable O.D. (0.255" to 0.314") |
| CONTACT PLATING³ | Blank = Standard Plating (Silver or Tin) (Refer to Standard Data) AU = Gold Plated |
| PACKAGING | Blank = Individual Bags BULK = Bulk Packed |

ISO VIEW OF AC3MM

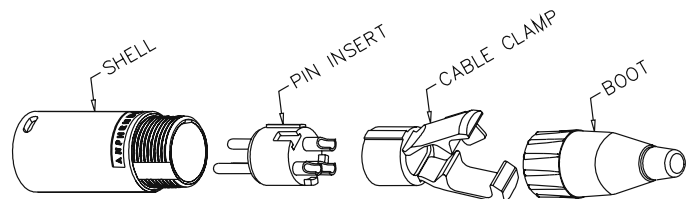

Note:

- ¹ 4 - 7 contact connectors have machined contacts and grounding as standard.
- ² Ground contacts are not supplied with the black polyester finish shell option.
- ³ 7 Contact is gold plated as standard.
- ⁴ All AC Series Connectors are available with optional colour coded boot / backshell. Refer to page 134 and simply add colour to end of part number. Example: AC3MM - RED



Features:

- Thermoplastic Shell.
- Solder Bucket Connections.
- “Jaws” Cable Retention System.
- Stamped or Machined Contacts.
- Leading first mate last break socket contact.
- Quick and easy assembly without screws – by hand or portable termination tool. (Part number T2860.)

Options: Gold Plated Contacts, Stamped Contacts (3 Contact only), Bulk Pack, Coloured Boots / Backshells
3, 4, 5, 6A and 7 Contacts.

Specifications: Page 16



| PRODUCT - FIGURE | DRAWING | DESCRIPTION | VARIATIONS | PART NUMBER |
|------------------|---------|---|----------------------|--------------|
| | | XLR 3 pole male, Machined contacts, Thermoplastic shell, Jaws cable clamp | Standard | AC3MMCP |
| | | | Gold Plated Contacts | AC3MMCP-AU |
| | | | Large Cable Clamp | AC3MMCPJ |
| | | | Bulk Pack | AC3MMCP BULK |
| | | XLR 3 pole male, Stamped contacts, Thermoplastic shell, Jaws cable clamp | Standard | AC3MCP |
| | | | Gold Plated Contacts | AC3MCP-AU |
| | | | Large Cable Clamp | AC3MCPJ |
| | | | Bulk Pack | AC3MCP BULK |
| | | XLR 3 pole female, Stamped contacts, Thermoplastic shell, Jaws cable clamp | Standard | AC3FCP |
| | | | Gold Plated Contacts | AC3FCP-AU |
| | | | Large Cable Clamp | AC3FCPJ |
| | | | Bulk Pack | AC3FCP BULK |

Note: Thermoplastic shell connectors are also available in 4 - 7 contact arrangements, please contact us for ordering code.

ISO VIEW OF AC3MM

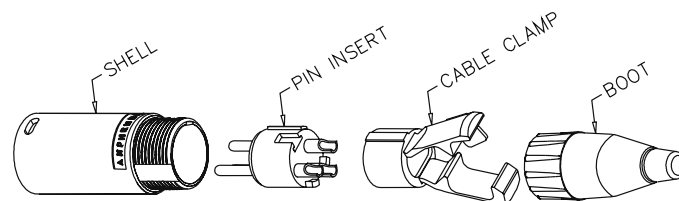

STANDARD DATA AC CABLE CONNECTORS

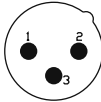
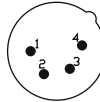
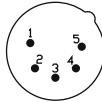
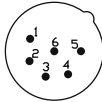
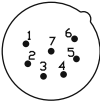
| | | VALUE | | | | |
|-----------------------------------|--|---|---|---|---|---|
| GENERAL CHARACTERISTICS | Number of contacts | 3 | 4 | 5 | 6A | 7 |
| | AC Series Contact Arrangements (Front view of pin inserts) |  |  |  |  |  |
| | Termination | SOLDER | | | | |
| | Max. Wire Gauge - Stranded wire: Solder | 14AWG | 16AWG | 18AWG | | 20AWG |
| | Flammability rating of insulator plastics and housings | UL94V-0 | | | | |
| | Environmental | Complies with EU RoHS 2 Directive 2011/65/EU | | | | |
| ELECTRICAL CHARACTERISTICS | Service Voltage RMS | 133V ¹ | | | | |
| | Test Voltage AC RMS | 1400V | | | | |
| | Current carrying capacity: Solder | 15A | 10A | 7.5A | | 5A |
| | Typical Contact Resistance | ≤3mΩ | | | | |
| | Insulation Resistance | ≥1GΩ | | | | |
| CLIMATIC CHARACTERISTICS | Protection Class | IP40 | | | | |
| | Operating Temperature | -25 °C to +75 °C (-13°F to +167°F) | | | | |
| MECHANICAL CHARACTERISTICS | Insertion and Withdrawal force | ≥10N - ≤30N | | | | |
| | Weight - Metal ² | 36g (0.080lb) | 37g (0.081lb) | 38g (0.083lb) | | |
| | Weight - Thermoplastic ² | 18g (0.039lb) | 19g (0.041lb) | 20g (0.044lb) | | |
| | Typical Cable retention force | 22Kg to 44Kg (50lb to 100lb) - Dependent on cable material and diameter. | | | | |
| | Cable O.D. range - JAWS clamp Standard Solder Large Solder | 3mm to 6.5mm (0.118" to 0.255") 6.5mm to 8mm (0.255" to 0.314") | | | | |
| | Mechanical Operations | 1000 mating cycles | | | | |

Rev 6 - 03/2015

¹) Not suitable for domestic applications above 50V

²) Approximate weight only, does not include packaging. Please contact us for exact weight for shipping purposes.

STANDARD DATA AC CABLE CONNECTORS

| MATERIALS | | DETAILS |
|---------------------------------|---|---|
| Connector shell - Metal | Shell finish | Diecast Zinc Alloy Satin nickel or Black polyester |
| Connector shell - Thermoplastic | Shell finish | Thermoplastic, UL94V-0 Modified PPE Resin Black |
| Insulators | | UL94V-0 PBT Resin or Modified PPE Resin |
| Boot / Backshell | Finish | UL94V-0 Modified PPE Resin or Machined Brass Black, other colours available - see page 134 |
| Cable clamp | Standard Solder JAWS Large Solder JAWS | UL94V-0 Modified PPO Resin (Black) UL94V-0 Modified PPO Resin (Purple) |
| Cable Bushing | | Santoprene |
| Male Contact | Stamped - Solder / Plating Machined - Solder / Plating | Phosphor Bronze / Silver or Gold (Optional) Brass / Silver or Gold (Optional) |
| Female Contact | Stamped - Solder / Plating Machined - Solder / Plating | Phosphor Bronze / Tin or Gold (Optional) Brass / Silver or Gold (Optional) |



Rev 6 - 03/2015

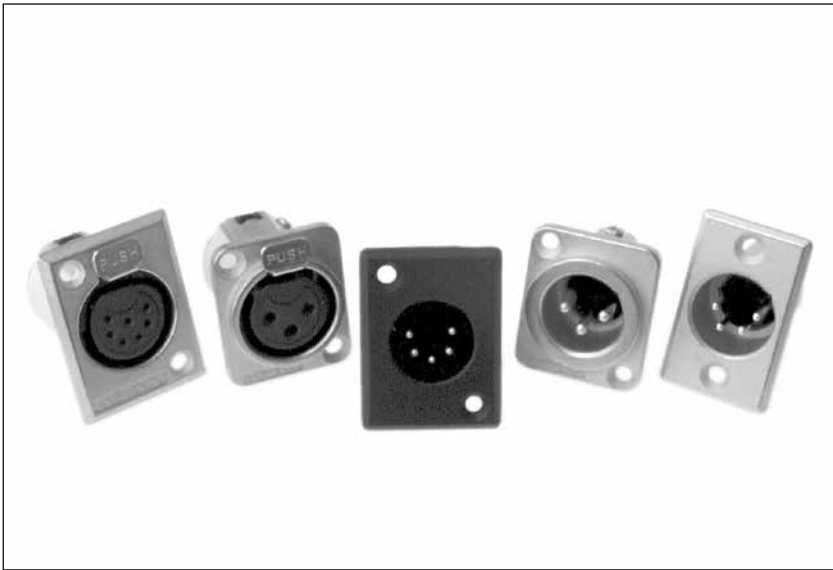

AC “Z” SERIES XLR METAL CHASSIS MOUNT CONNECTORS

The metal chassis mount “Z” series connectors are designed for the audio user where durability, reliability and strength across a wide range of applications are important. All AC products are manufactured to the highest quality standards and will withstand the harshest environments. This range complies with IEC268-12 and AES 14-1992 standards. CSA File Number 68598

Note: A ground tag is standard on all AC “Z” series connectors. Although the ground tag is intended for RFI shielding applications, Amphenol cannot guarantee its effectiveness in all cases.

The non-conductive Black polyester finish insulates the ground tag from the shell and should not be used in applications requiring ground contact to the shell.

Simple steps to guide you in using this catalogue

- 1) Identify the product group listed in Contents on page 1 and go directly to that page number.
- 2) Each product group cover page then details information and options available.
- 3) Refer to the product detail pages and identify the product you require pictorially.
- 4) Read the product description column for the products standard features.
- 5) Use variations column to determine your choice.
- 6) Identify part number.
- 7) In the event the particular option you require is not listed please refer to the part number breakdown page at the end of each section.
- 8) Please contact us directly if you have any further problems.

Features

- The “D” size housing can be either front or rear mounted using the same panel cutout.
- The “P” size housing is the original wide flange front mounting XLR connector. “PN” is the original narrow flange front mounting male connector.
- A leading first mate last break socket contact is standard on all female connectors (Pin 1).
- Solder cup or Vertical PCB versions.
- Connectors are fitted with a grounding system for RFI shielding applications.
- Available in 3, 4, 5, 6A and 7 contact arrangements.
- Compatible with all other XLR brands.

Options

- Solder Bucket termination
- Vertical PCB contacts
- Zinc Diecast Shell - Satin Nickel Finish
- Zinc Diecast Shell - Black Polyester Finish
- Gold, Silver or Tin Plated Contacts
- Bulk Packaging
- Single Bag packs
- Precision machined contacts
- Cost effective stamped contacts on 3 pole
- Latchless versions (Non-Latching) (Female only)

Ordering Codes

We have listed the more common ordering codes in each section. For further options please refer to the part number breakdown charts. Please contact us if you need any further assistance.



Features:

- Zinc Diecast Shell.
- D size housing can be front or rear mounted using the same panel cutout.
- Solder Bucket connections.
- Vertical PCB mounting (not available in 4 contact female).
- Precision machined or Stamped contacts (3 pin only).
- Leading first mate last break socket contact.
- Positive latch lock system.

Options: Stamped contacts (3 contact only), Gold plated contacts, Vertical PCB contacts, Black finish, Non-Latching (Female only), Bulk Pack.

Part Number Breakdown: Page 25











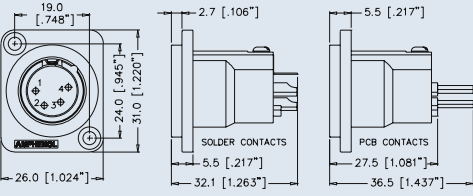

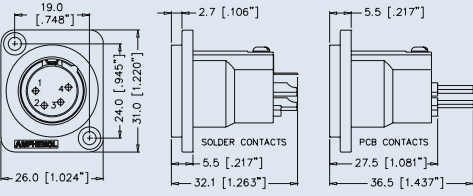

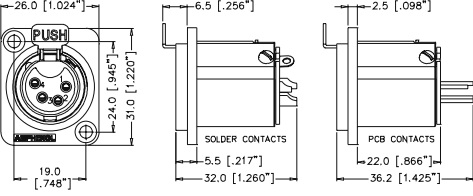
Specifications: Page 26

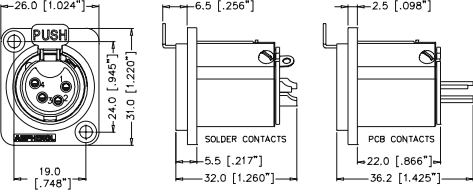
PCB Footprints: Page 27

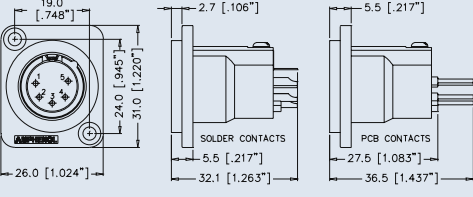
Panel Cutouts: Page 27

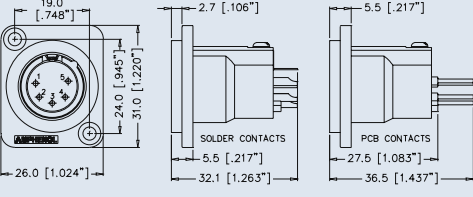

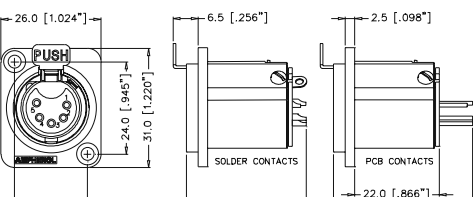
| PRODUCT - FIGURE | DRAWING | Dimensions in mm (inches) | DESCRIPTION | VARIATIONS | PART NUMBER |
|------------------|---------|---------------------------|--|----------------------|---------------|
| | | | XLR 3 pole male, D Flange, Machined contacts, Nickel Finish | Standard | AC3MMDZ |
| | | | | Gold Plated Contacts | AC3MMDZ-AU |
| | | | | Vertical PCB | AC3MMDZV |
| | | | | Bulk Pack | AC3MMDZ BULK |
| | | | XLR 3 pole male, D Flange, Machined contacts, Black Finish | Standard | AC3MMDZB |
| | | | | Gold Plated Contacts | AC3MMDZB-AU |
| | | | | Vertical PCB | AC3MMDZVB |
| | | | | Bulk Pack | AC3MMDZB BULK |
| | | | XLR 3 pole male, D Flange, Stamped contacts, Nickel Finish | Standard | AC3MDZ |
| | | | | Gold Plated Contacts | AC3MDZ-AU |
| | | | | Bulk Pack | AC3MDZ BULK |
| | | | XLR 3 pole male, D Flange, Stamped contacts, Black Finish | Standard | AC3MDZB |
| | | | | Gold Plated Contacts | AC3MDZB-AU |
| | | | | Bulk Pack | AC3MDZB BULK |
| | | | XLR 3 pole female, D Flange, Stamped contacts, Nickel Finish | Standard | AC3FDZ |
| | | | | Gold Plated Contacts | AC3FDZ-AU |
| | | | | Bulk Pack | AC3FDZ BULK |
| | | | XLR 3 pole female, D Flange, Stamped contacts, Black Finish | Standard | AC3FDZB |
| | | | | Gold Plated Contacts | AC3FDZB-AU |
| | | | | Bulk Pack | AC3FDZB BULK |

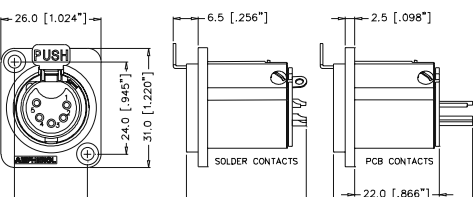
| PRODUCT - FIGURE | DRAWING | Dimensions in mm (inches) | DESCRIPTION | VARIATIONS | PART NUMBER |
|---|---|---------------------------|--|----------------------|--------------|
|  |  | | XLR 4 pole male, D Flange, Machined contacts, Nickel Finish | Standard | AC4MDZ |
| | | | | Gold Plated Contacts | AC4MDZ-AU |
| | | | | Vertical PCB | AC4MDZV |
| | | | | Bulk Pack | AC4MDZ BULK |
|  |  | | XLR 4 pole male, D Flange, Machined contacts, Black Finish | Standard | AC4MDZB |
| | | | | Gold Plated Contacts | AC4MDZB-AU |
| | | | | Vertical PCB | AC4MDZVB |
| | | | | Bulk Pack | AC4MDZB BULK |
|  |  | | XLR 4 pole female, D Flange, Machined contacts, Nickel Finish | Standard | AC4FDZ |
| | | | | Gold Plated Contacts | AC4FDZ-AU |
| | | | | Vertical PCB | AC4FDZV |
| | | | | Bulk Pack | AC4FDZ BULK |
|  |  | | XLR 4 pole female, D Flange, Machined contacts, Black Finish | Standard | AC4FDZB |
| | | | | Gold Plated Contacts | AC4FDZB-AU |
| | | | | Vertical PCB | AC4FDZVB |
| | | | | Bulk Pack | AC4FDZB BULK |
|  |  | | XLR 5 pole male, D Flange, Machined contacts, Nickel Finish | Standard | AC5MDZ |
| | | | | Gold Plated Contacts | AC5MDZ-AU |
| | | | | Vertical PCB | AC5MDZV |
| | | | | Bulk Pack | AC5MDZ BULK |
|  |  | | XLR 5 pole male, D Flange, Machined contacts, Black Finish | Standard | AC5MDZB |
| | | | | Gold Plated Contacts | AC5MDZB-AU |
| | | | | Vertical PCB | AC5MDZVB |
| | | | | Bulk Pack | AC5MDZB BULK |
|  |  | | XLR 5 pole female, D Flange, Machined contacts, Nickel Finish | Standard | AC5FDZ |
| | | | | Gold Plated Contacts | AC5FDZ-AU |
| | | | | Vertical PCB | AC5FDZV |
| | | | | Bulk Pack | AC5FDZ BULK |
|  |  | | XLR 5 pole female, D Flange, Machined contacts, Black Finish | Standard | AC5FDZB |
| | | | | Gold Plated Contacts | AC5FDZB-AU |
| | | | | Vertical PCB | AC5FDZVB |
| | | | | Bulk Pack | AC5FDZB BULK |

| PRODUCT - FIGURE | DRAWING | DESCRIPTION | VARIATIONS | PART NUMBER |
|------------------|--------------|---|----------------------|---------------|
| | | XLR 6A pole male, D Flange, Machined contacts, Nickel Finish | Standard | AC6AMDZ |
| | | | Gold Plated Contacts | AC6AMDZ-AU |
| | | | Vertical PCB | AC6AMDZV |
| | | | Bulk Pack | AC6AMDZ BULK |
| | | XLR 6A pole male, D Flange, Machined contacts, Black Finish | Standard | AC6AMDZB |
| | | | Gold Plated Contacts | AC6AMDZB-AU |
| | | | Vertical PCB | AC6AMDZVB |
| | | | Bulk Pack | AC6AMDZB BULK |
| | | XLR 6A pole female, D Flange, Machined contacts, Nickel Finish | Standard | AC6AFDZ |
| | | | Gold Plated Contacts | AC6AFDZ-AU |
| | | | Vertical PCB | AC6AFDZV |
| | | | Bulk Pack | AC6AFDZ BULK |
| | | XLR 6A pole female, D Flange, Machined contacts, Black Finish | Standard | AC6AFDZB |
| | | | Gold Plated Contacts | AC6AFDZB-AU |
| | | | Vertical PCB | AC6AFDZVB |
| | | | Bulk Pack | AC6AFDZB BULK |
| | | XLR 7 pole male, D Flange, Gold Plated Machined contacts, Nickel Finish | Standard | AC7MDZ |
| | | | Vertical PCB | AC7MDZV |
| | | | Bulk Pack | AC7MDZ BULK |
| | | | | |
| Vertical PCB | AC7MDZVB | | | |
| Bulk Pack | AC7MDZB BULK | | | |
| | | XLR 7 pole female, D Flange, Gold Plated Machined contacts, Nickel Finish | | |
| | | | Vertical PCB | AC7FDZV |
| | | | Bulk Pack | AC7FDZ BULK |
| | | | | |
| Vertical PCB | AC7FDZVB | | | |
| Bulk Pack | AC7FDZB BULK | | | |



METAL P TYPE FLANGE - SOLDER AND PCB













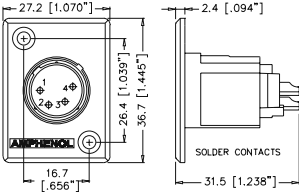

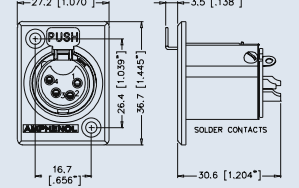

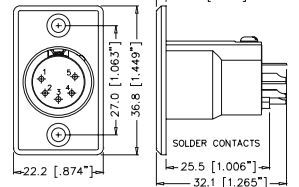
Features:

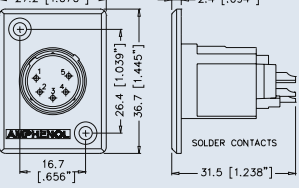
- Zinc Diecast shell.
- The P size housing is the original wide flange front mounting XLR connector. PN is the original narrow, front mounting male connector.
- Solder Bucket connections.
- Precision Machined or Stamped contacts (3 pin only).
- Leading first mate last break socket contact.
- Positive latch lock system.

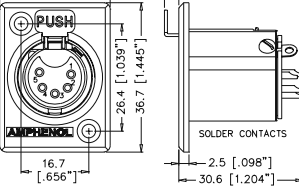

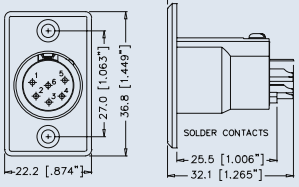

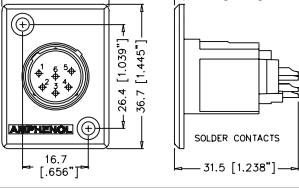
Options: Stamped contacts (3 contact only), Gold plated contacts, Black Finish, Non-Latching (Female only), Bulk Pack.

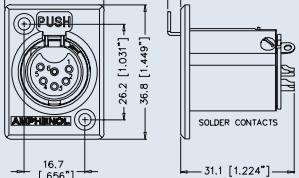
Part Number Breakdown: Page 25 Specifications: Page 26
PCB Footprints: Page 27 Panel Cutouts: Page 27

| PRODUCT - FIGURE | DRAWING | Dimensions in mm (inches) | DESCRIPTION | VARIATIONS | PART NUMBER |
|------------------|---------|--|---|--------------------------|-----------------------|
| | | 2.4 [.094"] 27.0 [1.063"] 36.8 [1.449"] 22.2 [.874"] 32.1 [1.265"] | XLR 3 pole male, Narrow flange, Machined contacts | Standard Black Finish | AC3MMPNZ AC3MMPNZB |
| | | 2.4 [.094"] 27.0 [1.063"] 36.8 [1.449"] 22.2 [.874"] 32.1 [1.265"] | XLR 3 pole male, Narrow flange, Stamped contacts, | Standard Black Finish | AC3MPNZ AC3MPNZB |
| | | 27.2 [1.070"] 26.4 [1.039"] 36.7 [1.445"] 16.7 [.656"] 31.5 [1.238"] | XLR 3 pole male, Wide flange, Machined contacts | Standard Black Finish | AC3MMP AC3MMPB |
| | | 2.4 [.094"] 27.2 [1.070"] 26.4 [1.039"] 36.7 [1.445"] 16.7 [.656"] 32.5 [1.278"] | XLR 3 pole male, Wide flange, Stamped contacts | Standard Black Finish | AC3MP AC3MPB |
| | | 27.2 [1.070"] 26.4 [1.039"] 36.7 [1.445"] 16.7 [.656"] 3.5 [1.38"] 2.5 [.098"] 31.0 [1.220"] | XLR 3 pole female, Wide flange, Stamped contacts | Standard Black Finish | AC3FPZ AC3FPZB |
| | | 2.4 [.094"] 27.0 [1.063"] 36.8 [1.449"] 22.2 [.874"] 32.1 [1.265"] | XLR 4 pole male, Narrow flange, Machined contacts | Standard Black Finish | AC4MPNZ AC4MPNZB |

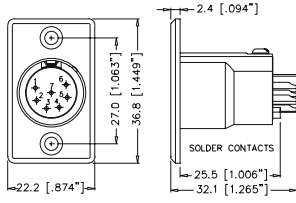
| PRODUCT - FIGURE | DRAWING | Dimensions in mm (inches) | DESCRIPTION | VARIATIONS | PART NUMBER |
|---|---|---|--|--------------------------|-----------------------|
|  |  | 27.2 [1.070"] 2.4 [.094"] 26.4 [1.039"] 36.7 [1.445"] 16.7 [.656"] 31.5 [1.238"] | XLR 4 pole male, Wide flange, Machined contacts | Standard Black Finish | AC4MP AC4MPB |
|  |  | 27.2 [1.070"] 3.5 [.138"] 26.4 [1.039"] 36.7 [1.445"] 16.7 [.656"] 30.6 [1.204"] | XLR 4 pole female, Wide flange, Machined contacts | Standard Black Finish | AC4FPZ AC4FPZB |
|  |  | 2.4 [.094"] 27.0 [1.063"] 36.8 [1.449"] 22.2 [.874"] 25.5 [1.006"] 32.1 [1.265"] | XLR 5 pole male, Narrow flange, Machined contacts | Standard Black Finish | AC5MPNZ AC5MPNZB |
|  |  | 27.2 [1.070"] 2.4 [.094"] 26.4 [1.039"] 36.7 [1.445"] 16.7 [.656"] 31.5 [1.238"] | XLR 5 pole male, Wide flange, Machined contacts | Standard Black Finish | AC5MP AC5MPB |
|  |  | 27.2 [1.070"] 3.5 [.138"] 26.4 [1.039"] 36.7 [1.445"] 16.7 [.656"] 30.6 [1.204"] | XLR 5 pole female, Wide flange, Machined contacts | Standard Black Finish | AC5FPZ AC5FPZB |
|  |  | 2.4 [.094"] 27.0 [1.063"] 36.8 [1.449"] 22.2 [.874"] 25.5 [1.006"] 32.1 [1.265"] | XLR 6A pole male, Narrow flange, Machined contacts | Standard Black Finish | AC6AMPNZ AC6AMPNZB |
|  |  | 27.2 [1.070"] 2.4 [.094"] 26.4 [1.039"] 36.7 [1.445"] 16.7 [.656"] 31.5 [1.238"] | XLR 6A pole male, Wide flange, Machined contacts | Standard Black Finish | AC6AMP AC6AMPB |
|  |  | 27.2 [1.071"] 3.5 [.138"] 26.2 [1.031"] 36.8 [1.449"] 16.7 [.656"] 31.1 [1.224"] | XLR 6A pole female, Wide flange, Machined contacts | Standard Black Finish | AC6AFPZ AC6AFPZB |

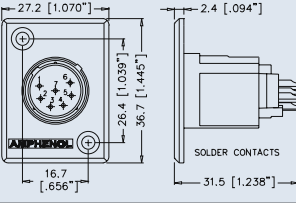

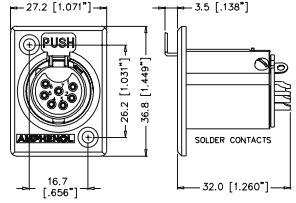
| PRODUCT - FIGURE | DRAWING | Dimensions in mm (inches) | DESCRIPTION | VARIATIONS | PART NUMBER |
|---|---|---------------------------|--|--------------|-------------|
|  |  | | XLR 7 pole male, Narrow flange, Gold Plated Machined contacts | Standard | AC7MPNZ |
| | | | | Black Finish | AC7MPNZB |
|  |  | | XLR 7 pole male, Wide flange, Gold Plated Machined contacts | Standard | AC7MP |
| | | | | Black Finish | AC7MPB |
|  |  | | XLR 7 pole female, Wide flange, Gold Plated Machined contacts | Standard | AC7FPZ |
| | | | | Black Finish | AC7FPZB |



PART NUMBER BREAKDOWN

METAL TYPE FLANGE

E. G. **AC3MMPNZVB-AU BULK**
AC (Series Prefix), **3** contacts, **M**ale, **M**achined Contacts, **PN** (Narrow Flange), **Z** (Metal Chassis Series), **B**lack Polyester Finish, **- AU** (Gold Plated Contacts), **BULK** Packaged.

| | | | |
|--------------------------------------|-------|---|--|
| SERIES PREFIX | AC | = | Series Prefix |
| CONTACT LAYOUTS | 3 | = | 3 Contacts |
| | 4 | = | 4 Contacts |
| | 5 | = | 5 Contacts |
| | 6A | = | 6 Contacts |
| | 7 | = | 7 Contacts |
| GENDER | F | = | Female Socket Contacts |
| | M | = | Male Pin Contacts |
| MACHINED CONTACTS¹ | Blank | = | Stamped Contacts |
| | M | = | Machined Contacts (Applicable 3 male pin contacts only) |
| SHELL STYLE | D | = | Small Flange (front or rear mounting) |
| | P | = | Large Shell with Wide Flange |
| | PN | = | Large Shell with Narrow Flange (male only) |
| SHELL SERIES | Blank | = | Male P Shell Style Only |
| | Z | = | Metal Chassis Series |
| SHELL FINISH² | Blank | = | Nickel Plated Finish |
| | B | = | Black Polyester Finish |
| CONTACT PLATING³ | Blank | = | Standard Plating (Silver or Tin - refer to Standard Data) |
| | AU | = | Gold Plated |
| PACKAGING | Blank | = | Individual Bags |
| | BULK | = | Bulk Packed |

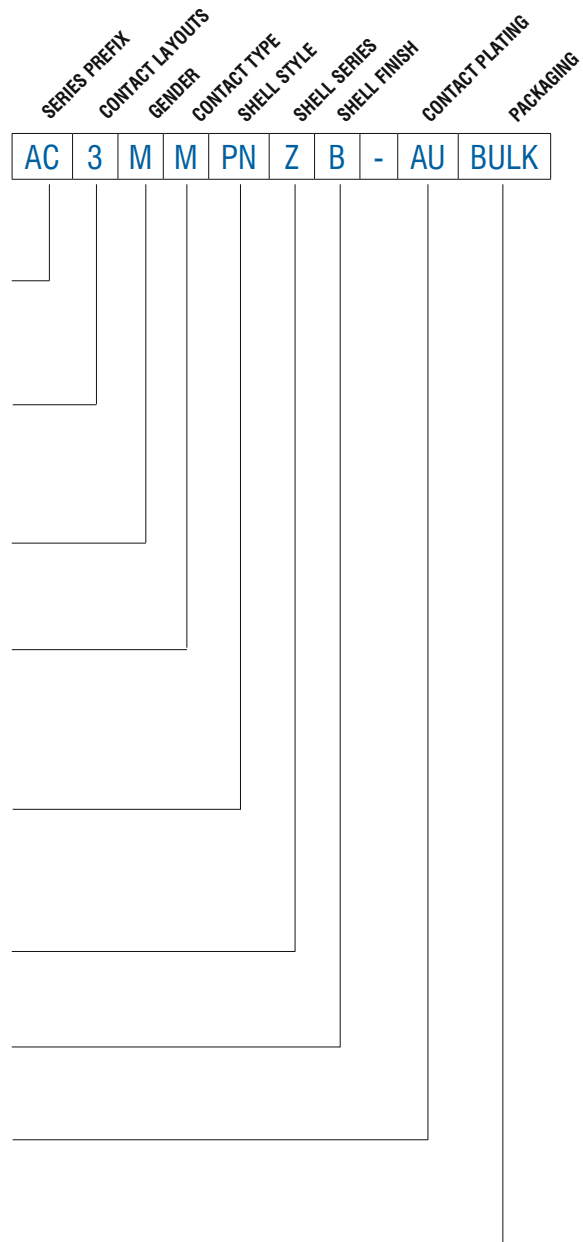

Note:

¹ 4 - 7 contact connectors have machined contacts and grounding as standard. They are not available in stamped contacts.

² Ground contacts are not supplied with the black polyester finish shell option.

³ 7 Contact is gold plated as standard.

⁴ Non-Latching Versions (Female) available - Please contact us for part number options.

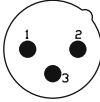
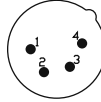
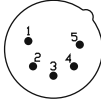
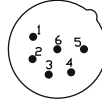
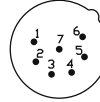

STANDARD DATA AC SERIES CHASSIS - METAL "Z"

| | | VALUE | | | | |
|---|--|---|---|---|---|---|
| GENERAL CHARACTERISTICS | Number of contacts | 3 | 4 | 5 | 6A | 7 |
| | Contact Arrangement (Front view of pin inserts) |  |  |  |  |  |
| | Termination | Solder Bucket / Printed Circuit Board (PCB) | | | | |
| | Max. Wire Gauge - Stranded wire: | | | | | |
| | Solder | 14AWG | 16AWG | 18AWG | 18AWG | 20AWG |
| | Printed Circuit Board - PCB | N/A | N/A | N/A | N/A | N/A |
| Flammability rating of plastics | UL94V-0 | | | | | |
| Environmental | Complies with EU RoHS 2 Directive 2011/65/EU | | | | | |
| ELECTRICAL CHARACTERISTICS | Service Voltage RMS | 133V ¹⁾ | | | | |
| | Test Voltage AC RMS | 1400V | | | | |
| | Current carrying capacity: | | | | | |
| | Solder | 15A | 10A | 7.5A | 7.5A | 5A |
| | Printed Circuit Board (PCB) | 15A | 10A | 7.5A | 7.5A | 5A |
| | Typical Contact Resistance | ≤3mΩ | | | | |
| Insulation Resistance | ≥1000MΩ | | | | | |
| CLIMATIC CHARACTERISTICS | Protection Class | IP40 | | | | |
| | Operating Temperature | -25 °C to +75 °C (-13°F to +167°F) | | | | |
| MECHANICAL CHARACTERISTICS | Weight - Metal ²⁾ | 31g (0.068lb) | 32g (0.070lb) | 33g (0.072lb) | 33g (0.072lb) | 33g (0.072lb) |
| | Mechanical Operations | 1000 mating cycles | | | | |
| MATERIALS | Connector Shell | Diecast Zinc Alloy | | | | |
| | Shell Finish | Satin Nickel or Black Polyester | | | | |
| | Insulators | UL94V-0 PBT Resin or Modified PPE Resin | | | | |
| | Male Contact | | | | | |
| | Stamped Solder and PCB-(Material/Plating) | Phosphor Bronze / Silver or Gold (optional) | | | | |
| | Machined Solder-(Material/Plating) | Brass / Silver or Gold (optional) | | | | |
| | Female Contact | | | | | |
| Stamped Solder and PCB-(Material/Plating) | Phosphor Bronze / Tin or Gold (optional) | | | | | |
| Machined Solder-(Material/Plating) | Brass / Silver or Gold (Optional) | | | | | |

Rev 3 - 03/2013

¹⁾ Not suitable for domestic applications above 50V

²⁾ Approximate weight only, does not include packaging. Please contact us for exact weight for shipping purposes.

AC SERIES CHASSIS METAL "Z"

PCB FOOTPRINTS STRAIGHT (V)

CONNECTOR SIDE OF PCB

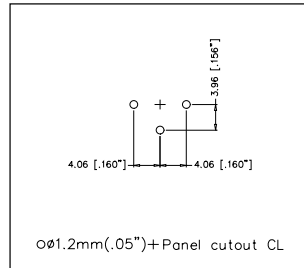

AC3MM*ZV

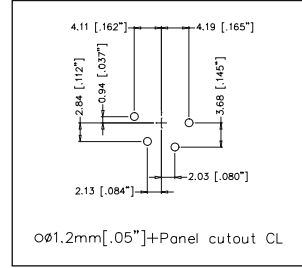

AC4F*ZV

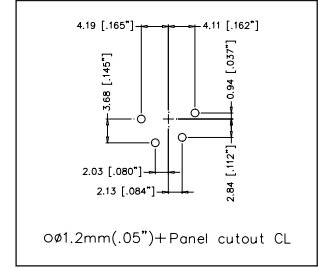

AC4M*ZV

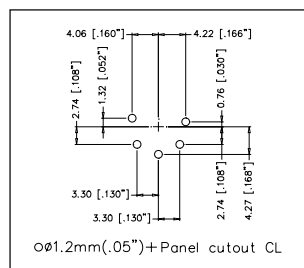

AC5F*ZV

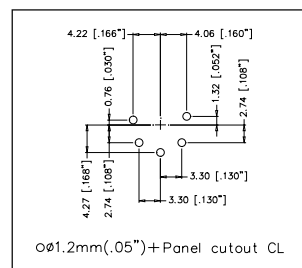

AC5M*ZV

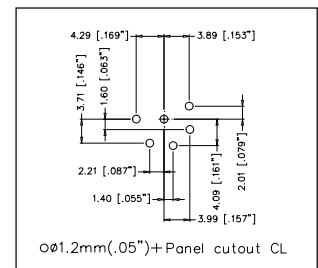

AC6AF*ZV

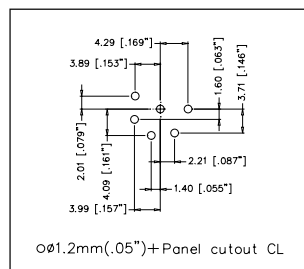

AC6AM*ZV

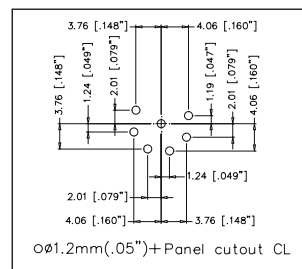

AC7F*ZV

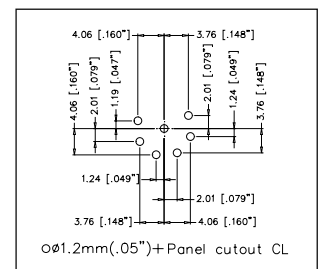

AC7M*ZV

PANEL CUTOUT DIMENSIONS

FRONT VIEW

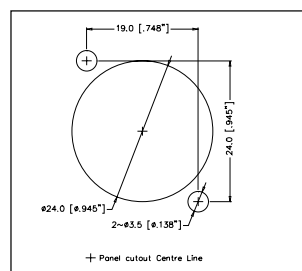

AC*FDZ

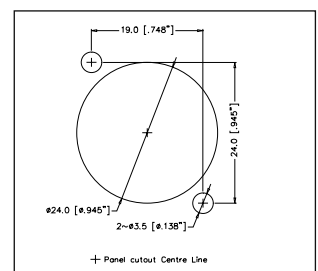

AC*MDZ

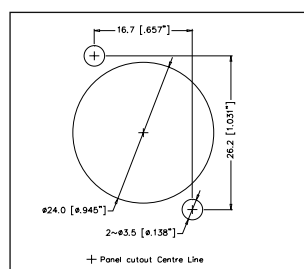

AC*FPZ

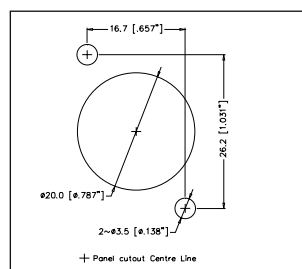

AC*MP

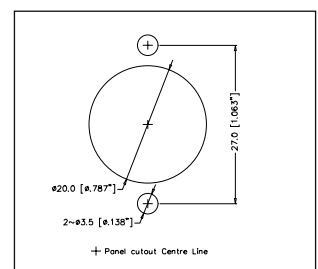

AC*MPNZ



AC SERIES XLR PCB CHASSIS MOUNT CONNECTORS



The AC series, A and B type XLR chassis receptacles have been designed and manufactured with the Original Equipment Manufacturers' (OEM) needs in mind. The compact shell design allows a significant space saving over the traditional 'D' type shell. Gold plated contacts improve the performance, ensuring a reliable contact and the unique grounding link options offer flexibility in design.

Features

- A leading first mate last break socket contact is standard on all female connectors (Pin 1).
- Vertical and Horizontal PCB versions available.
- Latching and Non-latching versions available.
- A range of different grounding options are available including:
 - Mating connector shell to Pin 1
 - Mating connector shell to Chassis
 - Mating connector shell to pin 1 to Chassis
- A type is available in 3 or 5 contacts.
- B type is available in 3 contact only.
- Compatible with all other XLR brands.
- Metal Mounting Flange (B type)

Options

- Vertical PCB contacts
- Horizontal PCB contacts
- Precision Machined Pin contacts
- Cost effective Stamped Socket contacts
- Gold Plated contacts (Standard)
- Silver Plated contacts (Optional)
- Bulk Packaging
- Integrated Switch

Ordering Codes

We have listed the more common ordering codes in each section. For further options please refer to the part number breakdown charts. Please contact us if you need any further assistance.

Simple steps to guide you in using this catalogue

- 1) Identify the product group listed in Contents on page 1 and go directly to that page number.
- 2) Each product group cover page then details information and options available.
- 3) Refer to the product detail pages and identify the product you require pictorially.
- 4) Read the product description column for the products standard features.
- 5) Use variations column to determine your choice.
- 6) Identify part number.
- 7) In the event the particular option you require is not listed please refer to the part number breakdown page at the end of each section.
- 8) Please contact us directly if you have any further problems.

Amphenol

AC SERIES CHASSIS CONNECTORS

THERMOPLASTIC A - TYPE FLANGE 3 CONTACT









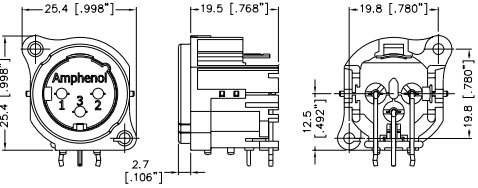

Features:

- Thermoplastic Shell
- Industry standard PCB footprints.
- Vertical or Horizontal PCB mounting.
- Precision machined pin contacts.
- Gold plated contacts.
- Leading first mate last break socket contact.
- Bulk packed in trays, 100 to a box as standard.
- Positive latch lock system.

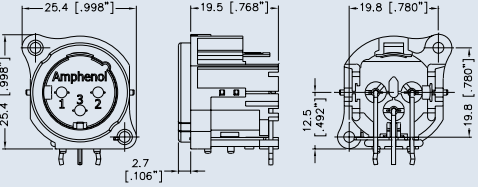
Options: Vertical or Horizontal PCB, Various grounding methods, Latching or Non-Latching.

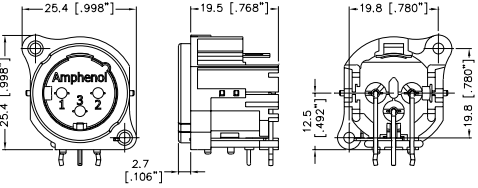
**Part Number Breakdown: Page 37 Specifications: Page 40
PCB Footprints: Page 41 Panel Cutouts: Page 42
Recommended Fastener: Page 132**

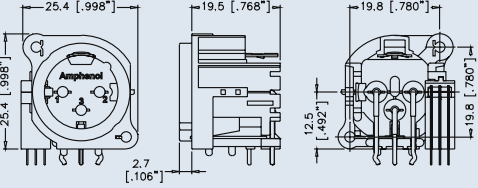

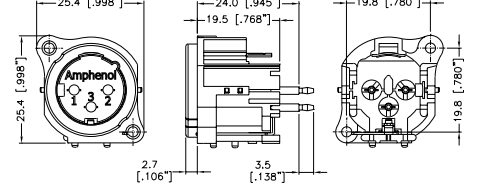







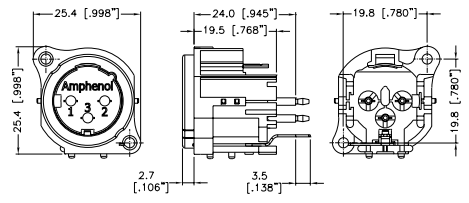

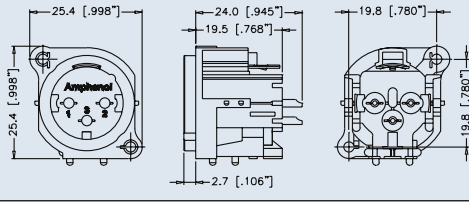

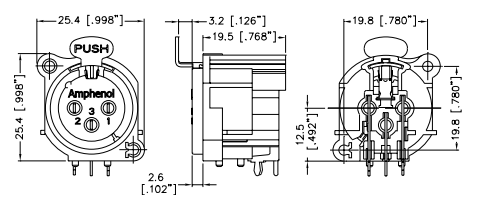

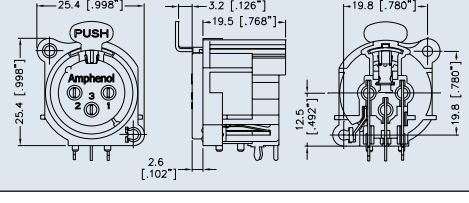

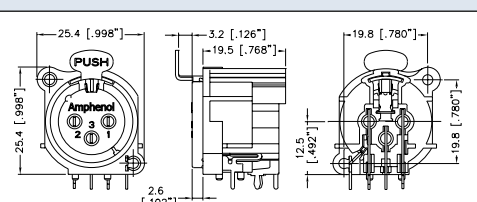

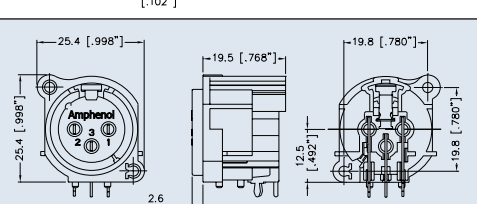

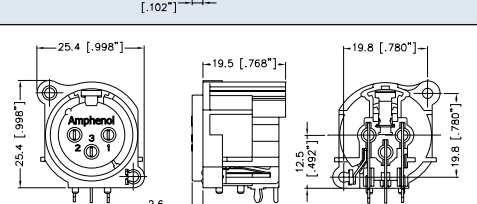

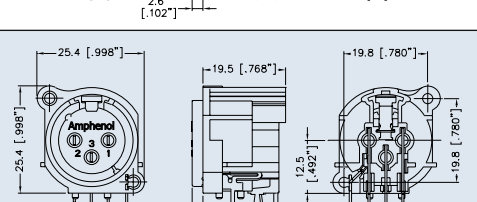

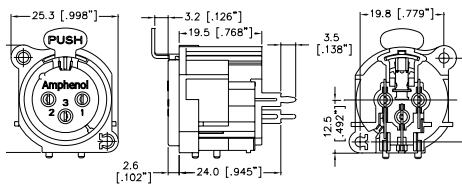

| PRODUCT - FIGURE | DRAWING | Dimensions in mm (inches) | DESCRIPTION | GROUND LINK VARIATIONS | PART NUMBER |
|---|---|---------------------------|---|---|----------------|
|  |  | | XLR 3 pole male, Horizontal PCB, Gold Plated Contacts, Bulk Pack | No Ground Link | AC3MAH-AU-PRE |
|  |  | | XLR 3 pole male, Horizontal PCB, Gold Plated Contacts, Bulk Pack | Pin 1 to Chassis to Mating connector shell | AC3MAH1-AU-PRE |
|  |  | | XLR 3 pole male, Horizontal PCB, Gold Plated Contacts, Bulk Pack | Mating connector shell to Chassis - Pin 1 sep. Ground | AC3MAH2-AU-PRE |
|  |  | | XLR 3 pole male with integrated switch, Horizontal PCB, Gold Plated Contacts, Bulk Pack | Mating connector shell to Chassis to PCB, Pin 1 sep. Ground | AC3MAH4-SW-B |
|  |  | | XLR 3 pole male, Vertical PCB, Gold Plated Contacts, Bulk Pack | No Ground Link | AC3MAV-AU-PRE |

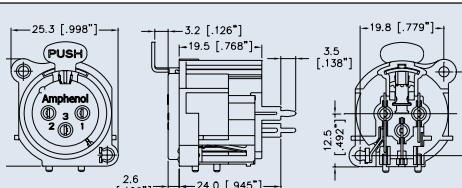
Amphenol

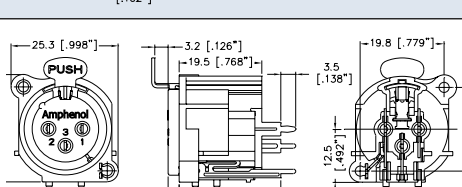
AC SERIES CHASSIS CONNECTORS

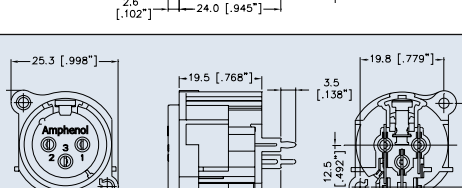
THERMOPLASTIC A TYPE FLANGE

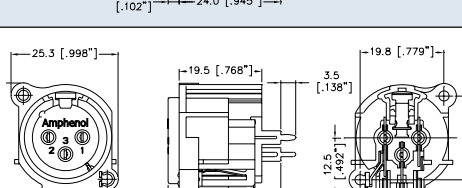
| PRODUCT - FIGURE | DRAWING | Dimensions in mm (inches) | DESCRIPTION | GROUND LINK VARIATIONS | PART NUMBER |
|---|---|---|--|--|-----------------|
|  |  | 25.4 [998] 24.0 [945] 19.5 [768] 19.8 [780] 2.7 [.106] 3.5 [.138] | XLR 3 pole male, Vertical PCB, Gold Plated Contacts, Bulk Pack | Mating connector shell to Chassis - Pin 1 sep. Ground | AC3MAV2-AU-PRE |
|  |  | 25.4 [998] 24.0 [945] 19.5 [768] 19.8 [780] 2.7 [.106] | XLR 3 pole male, Solder Buckets, Gold Plated Contacts, Bulk Pack | No Ground Link | AC3MA-AU-B |
|  |  | 25.4 [998] 3.2 [.126] 19.5 [768] 19.8 [780] 12.5 [.492] 2.6 [.102] | XLR 3 pole female, Horizontal PCB, Latching Type, Gold Plated Contacts, Bulk Pack | No Ground Link | AC3FAH-AU-PRE |
|  |  | 25.4 [998] 3.2 [.126] 19.5 [768] 19.8 [780] 12.5 [.492] 2.6 [.102] | XLR 3 pole female, Horizontal PCB, Latching Type, Gold Plated Contacts, Bulk Pack | Pin 1 to Chassis to Mating connector shell | AC3FAH1-AU-PRE |
|  |  | 25.4 [998] 3.2 [.126] 19.5 [768] 19.8 [780] 12.5 [.492] 2.6 [.102] | XLR 3 pole female, Horizontal PCB, Latching Type, Gold Plated Contacts, Bulk Pack | Mating connector shell to Chassis - Pin 1 sep. Ground | AC3FAH2-AU-PRE |
|  |  | 25.4 [998] 19.5 [768] 19.8 [780] 12.5 [.492] 2.6 [.102] | XLR 3 pole female, Horizontal PCB, Non-Latching Type Gold Plated Contacts, Bulk Pack | No Ground Link | AC3FAHL-AU-PRE |
|  |  | 25.4 [998] 19.5 [768] 19.8 [780] 12.5 [.492] 2.6 [.102] | XLR 3 pole female, Horizontal PCB, Non-Latching Type Gold Plated Contacts, Bulk Pack | Pin 1 to Chassis to mating connector shell | AC3FAHL1-AU-PRE |
|  |  | 25.4 [998] 19.5 [768] 19.8 [780] 12.5 [.492] 2.6 [.102] | XLR 3 pole female, Horizontal PCB, Non-Latching Type Gold Plated Contacts, Bulk Pack | Mating connector shell to Chassis - Pin 1 sep. Ground. | AC3FAHL2-AU-PRE |

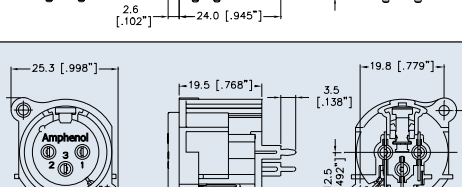
| PRODUCT - FIGURE | DRAWING | Dimensions in mm (inches) | DESCRIPTION | GROUND LINK VARIATIONS | PART NUMBER |
|---|---|---------------------------|---|--|-----------------|
|  |  | | XLR 3 pole female, Vertical PCB, Latching Type, Gold Plated Contacts, Bulk Pack | No Ground Link | AC3FAV-AU-PRE |
|  |  | | XLR 3 pole female, Vertical PCB, Latching Type, Gold Plated Contacts, Bulk Pack | Pin 1 to Chassis to Mating connector shell | AC3FAV1-AU-PRE |
|  |  | | XLR 3 pole female, Vertical PCB, Latching Type, Gold Plated Contacts, Bulk Pack | Mating connector shell to Chassis - Pin 1 sep. Ground. | AC3FAV2-AU-PRE |
|  |  | | XLR 3 pole female, Vertical PCB, Non-Latching Type, Gold Plated Contacts, Bulk Pack | No Ground Link | AC3FAVL-AU-PRE |
|  |  | | XLR 3 pole female, Vertical PCB, Non-Latching Type, Gold Plated Contacts, Bulk Pack | Pin 1 to Chassis to Mating connector shell | AC3FAVL1-AU-PRE |
|  |  | | XLR 3 pole female, Vertical PCB, Non-Latching Type, Gold Plated Contacts, Bulk Pack | Mating connector shell to Chassis - Pin 1 sep. Ground. | AC3FAVL2-AU-PRE |





Features:

- Thermoplastic Shell with Metal Mounting Flange.
- Industry standard PCB footprints.
- Improved grounding performance.
- Vertical or Horizontal PCB mounting.
- Precision machined pin contacts.
- Gold plated contacts.
- Leading first mate last break socket contact.
- Bulk packed in trays, 100 to a box as standard.
- Positive latch lock system.

Options: Silver plated contacts, Vertical or Horizontal PCB, Various grounding methods, Latching or Non-Latching.

Part Number Breakdown: Page 37 Specifications: Page 40
PCB Footprints: Page 41 Panel Cutouts: Page 42
Recommended Fastener: Page 132

| PRODUCT - FIGURE | DRAWING | Dimensions in mm (inches) | DESCRIPTION/ GROUND LINK | MOUNTING FLANGE VARIATIONS | PART NUMBER |
|------------------|---------|--|--|-------------------------------|--------------|
| | | 25.3 [.996"] 19.5 [.768"] 19.8 [.780"] 25.3 [.996"] 2.7 [.106"] 3.5 [.139"] 12.5 [.492"] 19.8 [.780"] | XLR 3 pole male, Horizontal PCB, Gold Plated Contacts, Bulk Pack No Ground Link | Nickel Finish | AC3MBH-AU-B |
| | | 25.3 [.996"] 19.5 [.768"] 19.8 [.780"] 25.3 [.996"] 2.7 [.106"] 3.5 [.139"] 12.7 [.500"] 19.8 [.780"] | XLR 3 pole male, Horizontal PCB, Gold Plated Contacts, Bulk Pack Pin 1 to Chassis to Mating connector shell | Nickel Finish | AC3MBH1-AU-B |
| | | 25.3 [.996"] 19.5 [.768"] 19.8 [.780"] 25.3 [.996"] 2.7 [.106"] 3.5 [.139"] 12.5 [.492"] 19.8 [.780"] | XLR 3 pole male, Horizontal PCB, Gold Plated Contacts, Bulk Pack Mating connector shell to Chassis - Pin 1 sep. Ground | Nickel Finish | AC3MBH2-AU-B |
| | | 25.3 [.996"] 19.5 [.768"] 19.8 [.780"] 25.3 [.996"] 2.7 [.106"] 3.5 [.139"] 12.5 [.492"] 19.8 [.780"] | XLR 3 pole male, Horizontal PCB, Gold Plated Contacts, Bulk Pack Mating connector shell to Pin 1 | Nickel Finish | AC3MBH3-AU-B |
| | | 25.3 [.996"] 19.5 [.768"] 19.8 [.780"] 25.3 [.996"] 2.7 [.106"] 3.5 [.139"] 12.5 [.492"] 19.8 [.780"] | XLR 3 pole male, Horizontal PCB, Non-Latching Type, Gold Plated Contacts, Bulk Pack No Ground Link | Nickel Finish | AC3MBHL-AU-B |
| | | 25.3 [.996"] 19.5 [.768"] 19.8 [.780"] 25.3 [.996"] 2.7 [.106"] 3.5 [.139"] 12.5 [.492"] 19.8 [.780"] 24.0 [.945"] | XLR 3 pole male, Vertical PCB, Gold Plated Contacts, Bulk Pack No Ground Link | Nickel Finish | AC3MBV-AU-B |





METAL B TYPE FLANGE

| PRODUCT - FIGURE | DRAWING | Dimensions in mm (inches) | DESCRIPTION/ GROUND LINK | MOUNTING FLANGE VARIATIONS | PART NUMBER |
|------------------|---------|---------------------------|--|-------------------------------|--------------|
| | | | XLR 3 pole male, Vertical PCB, Gold Plated Contacts, Bulk Pack Pin 1 to Chassis to Mating connector shell | Nickel Finish | AC3MBV1-AU-B |
| | | | XLR 3 pole male, Vertical PCB, Gold Plated Contacts, Bulk Pack Mating connector shell to Chassis - Pin 1 sep. Ground | Nickel Finish | AC3MBV2-AU-B |
| | | | XLR 3 pole male, Vertical PCB, Gold Plated Contacts, Bulk Pack Mating connector shell to Pin 1 | Nickel Finish | AC3MBV3-AU-B |
| | | | XLR 3 pole female, Horizontal PCB, Latching Type, Gold Plated Contacts, Bulk Pack No Ground Link | Nickel Finish | AC3FBH-AU-B |
| | | | XLR 3 pole female, Horizontal PCB, Latching Type, Gold Plated Contacts, Bulk Pack Pin 1 to Chassis to Mating connector shell | Nickel Finish | AC3FBH1-AU-B |
| | | | XLR 3 pole female, Horizontal PCB, Latching Type, Gold Plated Contacts, Bulk Pack Mating connector shell to Chassis - Pin 1 sep. Ground | Nickel Finish | AC3FBH2-AU-B |
| | | | XLR 3 pole female, Horizontal PCB, Latching Type, Gold Plated Contacts, Bulk Pack Pin 1 to Chassis | Nickel Finish | AC3FBH3-AU-B |
| | | | XLR 3 pole female, Horizontal PCB, Non-Latching Type Gold Plated Contacts, Bulk Pack No Ground Link | Nickel Finish | AC3FBHL-AU-B |

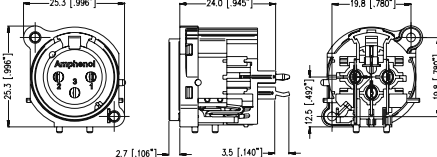

| PRODUCT - FIGURE | DRAWING | Dimensions in mm (inches) | DESCRIPTION/ GROUND LINK | MOUNTING FLANGE VARIATIONS | PART NUMBER |
|------------------|---------|---------------------------|---|-------------------------------|---------------|
| | | | XLR 3 pole female, Horizontal PCB, Non-Latching Type Gold Plated Contacts, Bulk Pack Pin 1 to Chassis to mating connector shell | Nickel Finish | AC3FBHL1-AU-B |
| | | | XLR 3 pole female, Horizontal PCB, Non- Latching Type, Gold Plated Contacts, Bulk Pack Mating connector shell to Chassis - Pin 1 sep. Ground. | Nickel Finish | AC3FBHL2-AU-B |
| | | | XLR 3 pole female, Horizontal PCB, Non-Latching Type Gold Plated Contacts, Bulk Pack Pin 1 to Chassis | Nickel Finish | AC3FBHL3-AU-B |
| | | | XLR 3 pole female, Vertical PCB, Latching Type, Gold Plated Contacts, Bulk Pack No Ground Link | Nickel Finish | AC3FBV-AU-B |
| | | | XLR 3 pole female, Vertical PCB, Latching Type, Gold Plated Contacts, Bulk Pack Pin 1 to Chassis to mating connector shell | Nickel Finish | AC3FBV1-AU-B |
| | | | XLR 3 pole female, Vertical PCB, Latching Type, Gold Plated Contacts, Bulk Pack Mating connector shell to Chassis - Pin 1 sep. Ground. | Nickel Finish | AC3FBV2-AU-B |
| | | | XLR 3 pole female, Vertical PCB, Latching Type, Gold Plated Contacts, Bulk Pack Pin 1 to Chassis | Nickel Finish | AC3FBV3-AU-B |
| | | | XLR 3 pole female, Vertical PCB, Non-Latching Type, Gold Plated Contacts, Bulk Pack No Ground Link | Nickel Finish | AC3FBVL-AU-B |

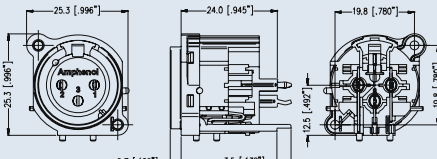

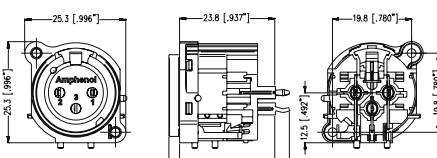
| PRODUCT - FIGURE | DRAWING | DESCRIPTION/ GROUND LINK | MOUNTING FLANGE VARIATIONS | PART NUMBER |
|---|--|--|-------------------------------|---------------|
|  |  <p>Dimensions in mm (inches)</p> | <p>XLR 3 pole female, Vertical PCB, Non-Latching Type, Gold Plated Contacts, Bulk Pack</p> <p>Pin 1 to Chassis to Mating connector shell</p> | Nickel Finish | AC3FBVL1-AU-B |
|  |  <p>Dimensions in mm (inches)</p> | <p>XLR 3 pole female, Vertical PCB, Non-Latching Type, Gold Plated Contacts, Bulk Pack</p> <p>Mating connector shell to Chassis-Pin 1 sep. Ground.</p> | Nickel Finish | AC3FBVL2-AU-B |
|  |  <p>Dimensions in mm (inches)</p> | <p>XLR 3 pole female, Vertical PCB, Non-Latching Type, Gold Plated Contacts, Bulk Pack</p> <p>Pin 1 to Chassis</p> | Nickel Finish | AC3FBVL3-AU-B |



THERMOPLASTIC A - TYPE FLANGE 5 CONTACT







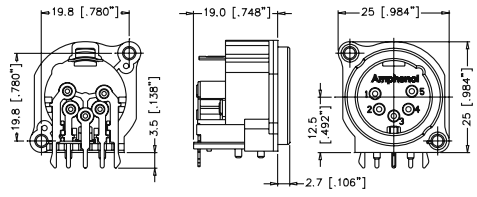

Features:

- 5 contacts.
- Thermoplastic Shell
- Industry standard PCB footprints.
- Vertical or Horizontal PCB mounting.
- Precision machined pin contacts.
- Gold plated contacts.
- Leading first mate last break socket contact.
- Bulk packed in trays, 100 to a box as standard.
- Positive latch lock system.

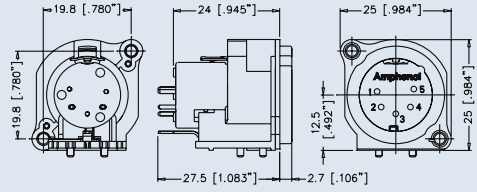
Options: Vertical or Horizontal PCB,

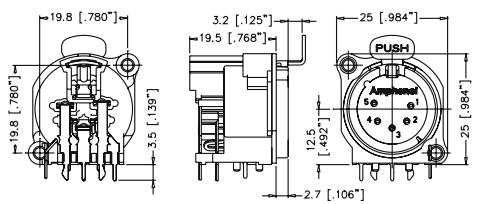
Part Number Breakdown: Page 39 **Specifications:** Page 40
PCB Footprints: Page 41 **Panel Cutouts:** Page 42
Recommended Fastener: Page 132

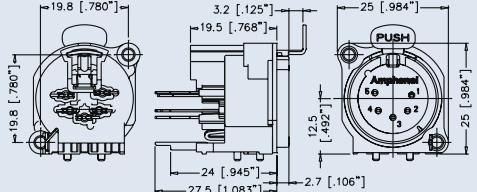
| PRODUCT - FIGURE | DRAWING | Dimensions in mm (inches) | DESCRIPTION/ GROUND LINK | MOUNTING FLANGE VARIATIONS | PART NUMBER |
|---|---|---|---|--|-------------|
|  |  | 19.8 [.780"] 19.0 [.748"] 25 [.984"] 19.8 [.780"] 3.5 [.138"] 19.5 [.492"] 2.7 [.106"] | XLR 5 pole male, Horizontal PCB, Gold Plated Contacts, Bulk Pack | Mating connector shell to Chassis to PCB, Pin 1 sep. Ground | AC5MAH-AU-B |
|  |  | 19.8 [.780"] 24 [.945"] 25 [.984"] 19.8 [.780"] 12.5 [.492"] 2.7 [.106"] 27.5 [1.083"] | XLR 5 pole male, Verti- cal PCB, Gold Plated Contacts, Bulk Pack | Mating connector shell to Chassis to PCB, Pin 1 sep. Ground | AC5MAV-AU-B |
|  |  | 19.8 [.780"] 19.5 [.768"] 25 [.984"] 19.8 [.780"] 3.5 [.138"] 19.5 [.492"] 2.7 [.106"] | XLR 5 pole female, Horizontal PCB, Gold Plated Contacts, Bulk Pack | Mating connector shell to Chassis to PCB, Pin 1 sep. Ground | AC5FAH-AU-B |
|  |  | 19.8 [.780"] 3.2 [.125"] 19.5 [.768"] 25 [.984"] 19.8 [.780"] 19.5 [.492"] 2.7 [.106"] 24 [.945"] 27.5 [1.083"] | XLR 5 pole female, Vertical PCB, Gold Plated Contacts, Bulk Pack | Mating connector shell to Chassis to PCB, Pin 1 sep. Ground | AC5FAV-AU-B |

PART NUMBER BREAKDOWN

AC SERIES A AND B TYPE MALE - 3 CONTACT

E. G. **AC3MAVL3-AU B**
AC (series prefix), **3** contacts, **M**ale, **A** Type, **V**ertical Printed Circuit Board, **L**atchless, **3** (Mating Shell to Pin 1 Grounding), **- AU** (Gold Plated Contacts), **B**ulk Packaged.

| | | | |
|---|-------|---|---|
| SERIES PREFIX | AC | = | Series Prefix |
| CONTACT LAYOUT | 3 | = | 3 Contact only |
| GENDER | M | = | Male Socket Contacts |
| SHELL SERIES | A | = | A Type |
| | B | = | B Type |
| TERMINATION | H | = | Horizontal Printed Circuit Board |
| | V | = | Vertical Printed Circuit Board |
| | Blank | = | Solder Bucket Contacts |
| MOUNTING FLANGE FINISH (B TYPE ONLY) | Blank | = | Nickel |
| LOCKING MECHANISM | Blank | = | Latching |
| | L | = | Latchless |
| GROUNDING LINK OPTIONS | Blank | = | No Ground Link |
| | 1 | = | Pin 1 to Chassis to mating connector shell |
| | 2 | = | Mating Connector shell to Chassis, Pin 1 to separate ground |
| | 3 | = | Mating connector to Pin 1 |
| CONTACT PLATING | AU | = | Gold Plated Contacts |
| | AG | = | Silver Plated Contacts (Non-Standard) |
| PACKAGING | B | = | Bulk Packed |

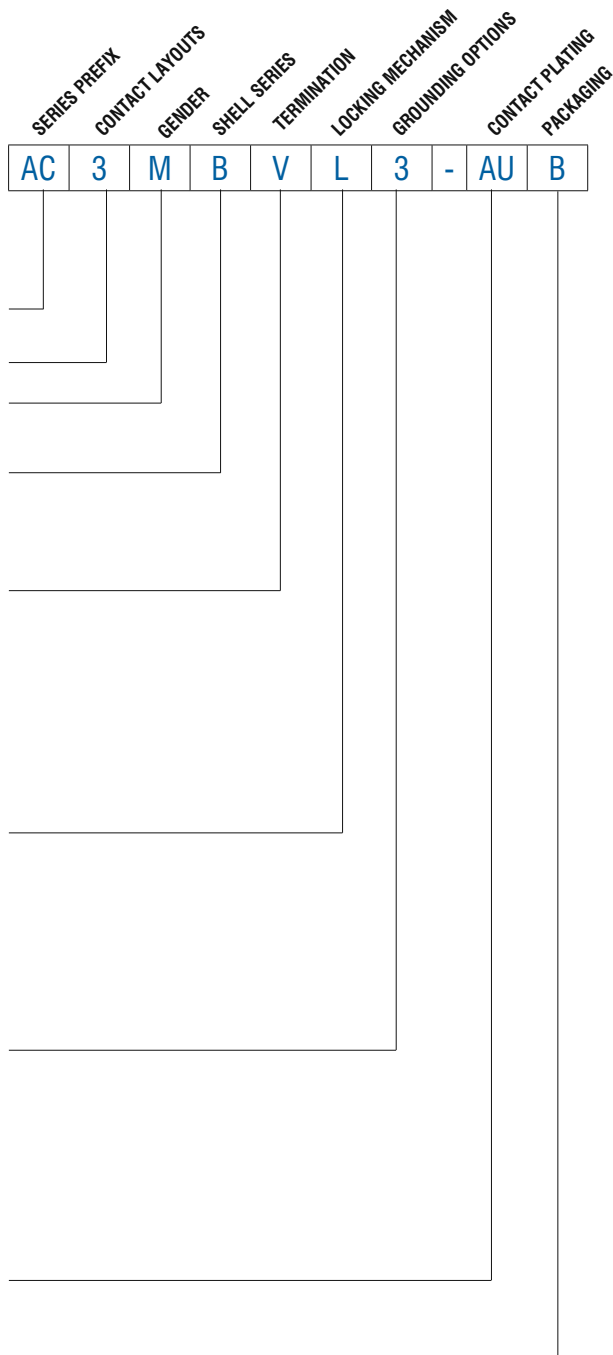

PART NUMBER BREAKDOWN

AC SERIES A AND B TYPE FEMALE - 3 CONTACT



E. G. **AC3MAVL3-AU B**
AC (series prefix), **3** contacts, **F**emale, **A** Type, **V**ertical Printed Circuit Board, **L**atchless, **3** (Pin 1 to Chassis Grounding), **- AU** (Gold Plated Contacts), **B**ulk Packaged.

| | | | |
|-------------------------------|-------|---|---|
| SERIES PREFIX | AC | = | Series Prefix |
| CONTACT LAYOUT | 3 | = | 3 Contact only |
| GENDER | F | = | Female Socket Contacts |
| SHELL SERIES | A | = | A Type |
| | B | = | B Type |
| TERMINATION | H | = | Horizontal Printed Circuit Board |
| | V | = | Vertical Printed Circuit Board |
| LOCKING MECHANISM | Blank | = | Latching |
| | L | = | Latchless |
| GROUNDING LINK OPTIONS | Blank | = | No Ground Link |
| | 1 | = | Pin 1 to Chassis to mating connector shell |
| | 2 | = | Mating Connector shell to Chassis, Pin 1 to separate ground |
| | 3 | = | Pin 1 to Chassis |
| CONTACT PLATING | AU | = | Gold Plated Contacts |
| | AG | = | Silver Plated Contacts (Non-Standard) |
| PACKAGING | B | = | Bulk Packed |

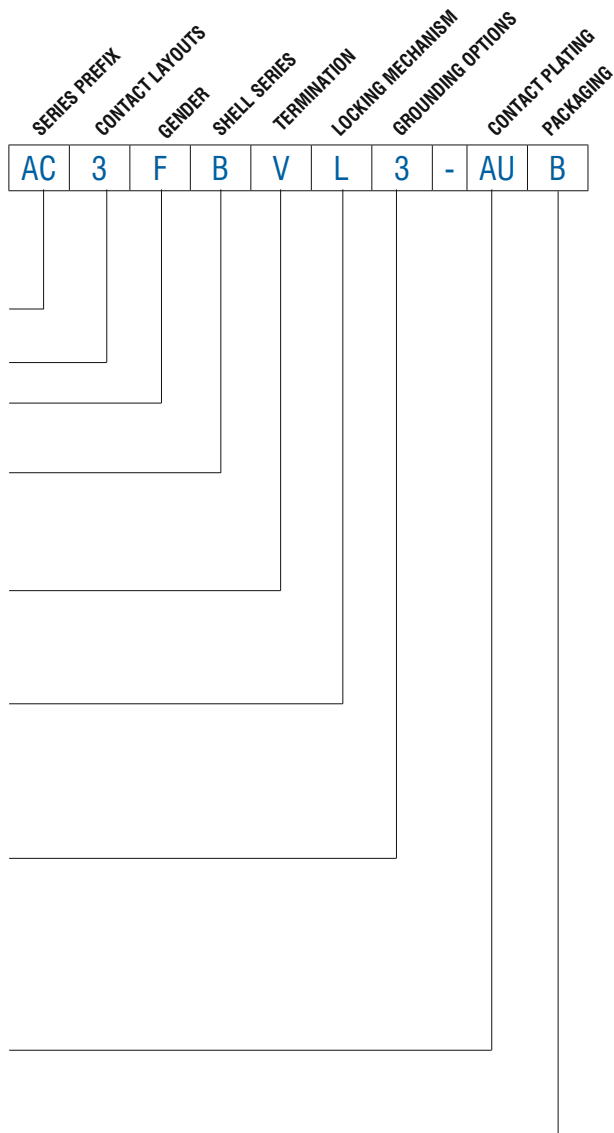

PART NUMBER BREAKDOWN



AC SERIES A TYPE MALE AND FEMALE - 5 CONTACT

E. G. **AC5FAV-AU-B**
AC (series prefix), **5** contacts, **F**emale, **A** Type, **V**ertical Printed Circuit Board, **AU**
 (Gold Plated Contacts) - **B**ulk Packaged.

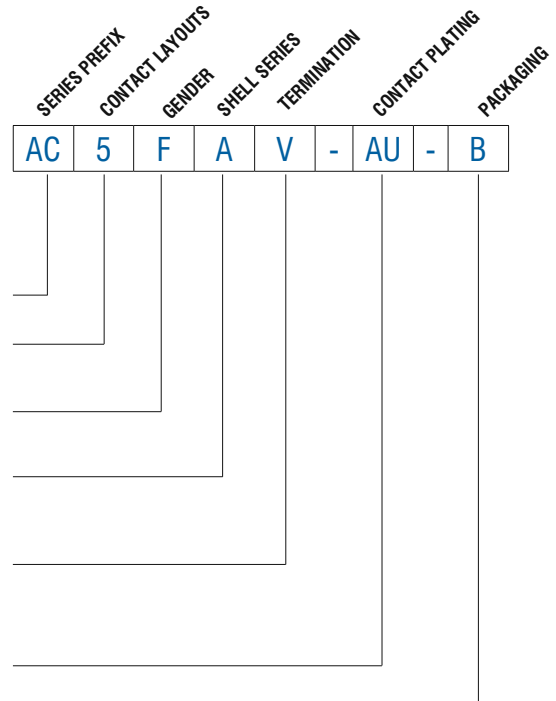
| | | | |
|------------------------|----|---|----------------------------------|
| SERIES PREFIX | AC | = | Series Prefix |
| CONTACT LAYOUT | 5 | = | 5 Contact only |
| GENDER | F | = | Female Socket Contacts |
| | M | = | Male Pin Contacts |
| SHELL SERIES | A | = | A Type |
| TERMINATION | H | = | Horizontal Printed Circuit Board |
| | V | = | Vertical Printed Circuit Board |
| CONTACT PLATING | AU | = | Gold Plated Contacts |
| PACKAGING | B | = | Bulk Packed |



STANDARD DATA AC SERIES A AND B TYPE CHASSIS

| | | VALUE | |
|-----------------------------------|--|---|---|
| GENERAL CHARACTERISTICS | Number of contacts | 3 | 5 |
| | Contact Arrangements (Front view of pin insert) |  |  |
| | Termination | Printed Circuit Board (PCB) | |
| | Flammability rating of plastics | UL94V-0 | |
| | Environmental | Complies with EU RoHS 2 Directive 2011/65/EU | |
| ELECTRICAL CHARACTERISTICS | Service Voltage RMS | 133V ¹⁾ | |
| | Test Voltage AC RMS | 1500V | |
| | Current carrying capacity | 6A | 3A |
| | Typical Contact Resistance | ≤5mΩ | |
| | Insulation Resistance (initial) | ≥2GΩ | |
| | Insulation Resistance (after damp heat test) | ≥1GΩ | |
| CLIMATIC CHARACTERISTICS | Protection Class | IP40 | |
| | Operating Temperature | -25 °C to +75 °C (-13°F to +167°F) | |
| MECHANICAL CHARACTERISTICS | Weight ²⁾ | 14g (0.030lb) | |
| | Retention Spring separating force | ≥20N | |
| | Mounting Screw torque max. | 1.5Nm | |
| | Mechanical Operations | 1500 mating cycles | |
| | Fastening A Type Connectors ³⁾ Fastening B Type Connectors ³⁾ | Self-Tapping PT screw with thread 2.9 x 1.06 and of Tri-rondular configuration Self-Tapping screw M2.5 | |
| MATERIALS | Connector Flange - B-Type Flange Finish - B-Type | Diecast Zinc Alloy Nickel | |
| | Insulators | PA6.6+25% glass fibre reinforced, UL94V-0 | |
| | Male Contact Material Male Contact Plating | Brass 0.05μm gold over 2μm nickel | |
| | Female Contact Material Female Contact Plating | Bronze 0.05μm gold over 2μm nickel | |
| | Latch lock and Spring | Spring Steel | |
| | Ground element | Spring Steel | |

¹ Not suitable for domestic applications above 50V

² Approximate weight only, does not include packaging. Please contact us for exact weight for shipping purposes.

³ Refer to page 132

AC SERIES A AND B TYPE CHASSIS PCB FOOTPRINTS STRAIGHT (V) - CONNECTOR SIDE OF PCB

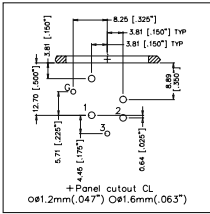

**AC3FAH2
AC3FBH2**

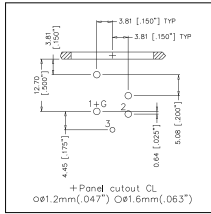

**AC3FAH1
AC3FAH3
AC3FBH1
AC3FBH3
AC3FAH
AC3FBH**

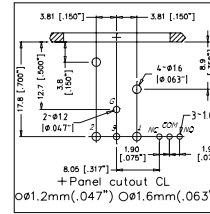

AC3MAH4SWB

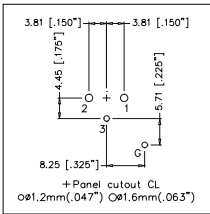

**AC3FAV2
AC3FBV2**

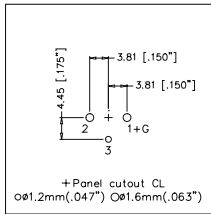

**AC3FAV1
AC3FAV3
AC3FBV1
AC3FBV3
AC3FAV
AC3FBV**

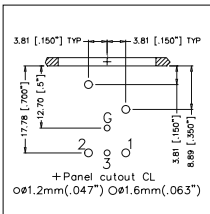

**AC3MAH2
AC3MAH4
AC3MBH2**

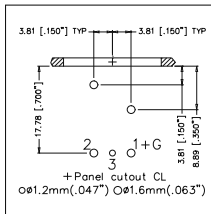

**AC3MAH1
AC3MAH3
AC3MBH1
AC3MBH3
AC3MAH
AC3MBH
AC3MBHL**

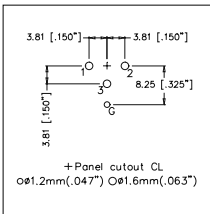

**AC3MAV2
AC3MAV4
AC3MBV2**

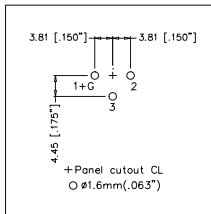

**AC3MAV1
AC3MAV3
AC3MBV1
AC3MBV3
AC3MAV
AC3MBV**

AC SERIES 5 PIN PCB FOOTPRINTS STRAIGHT (V) - CONNECTOR SIDE OF PCB

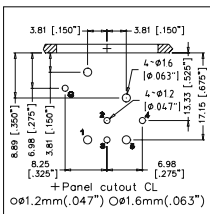

AC5FAH

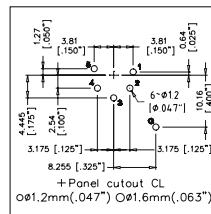

AC5FAV

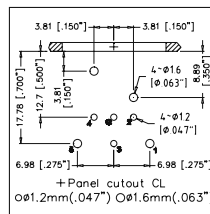

AC5MAH

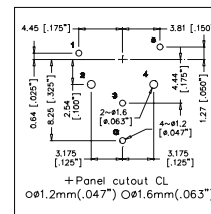

AC5MAV



AC SERIES A AND B TYPE CHASSIS

PANEL CUTOUT DIMENSIONS - FRONT VIEW

A TYPE

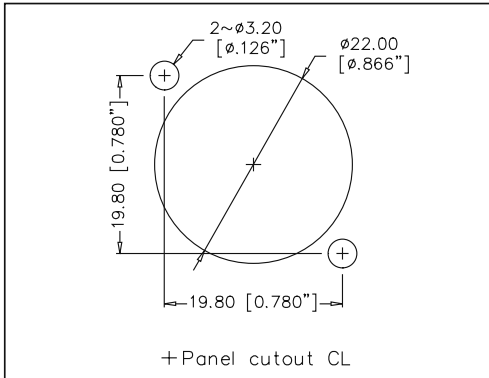

B TYPE

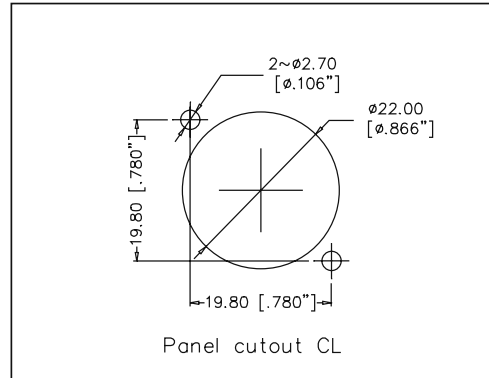

**A AND B
TYPE MALE
MOUNTING
PITCH**

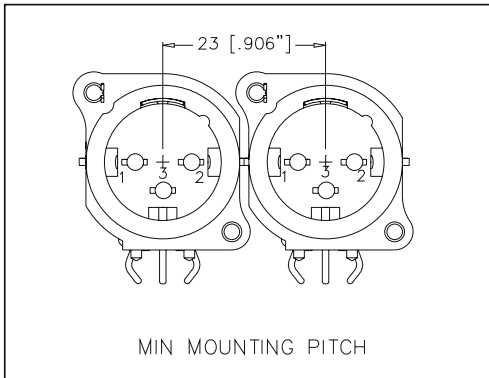

**A AND
B TYPE
FEMALE
MOUNTING
PITCH**

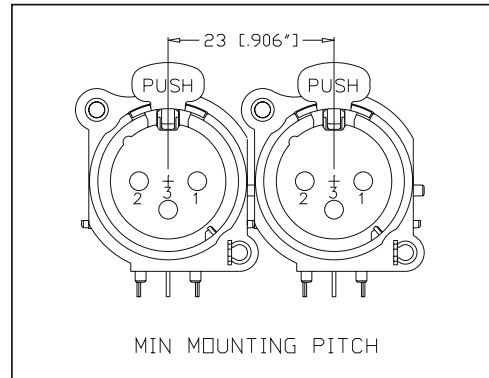

AC3FA/BH/V SCHEMATIC CHART

AC3FA/BH/V3-AU
AC3FA/BH/VL3-AU

AC3FA/BH/V2-AU
AC3FA/BH/VL2-AU

AC3FA/BH/V1-AU
AC3FA/BH/VL1-AU

AC3FA/BH/V-AU
AC3FA/BH/VL-AU

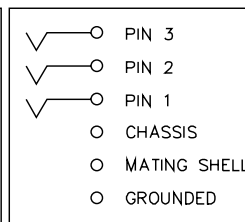
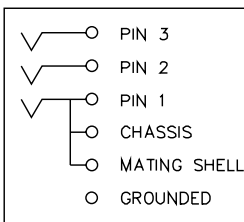
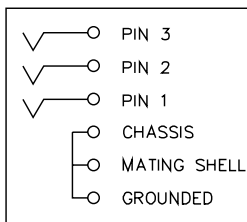
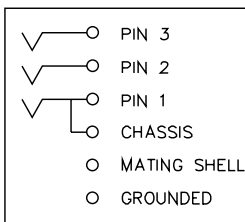

AC3MA/BH/V3-AU
AC3MA/BH/VL3-AU

AC3MA/BH/V2/4-AU
AC3MA/BH/VL2/4-AU

AC3MA/BH/V1-AU
AC3MA/BH/VL1-AU

AC3MA/BH/V-AU
AC3MA/BH/VL-AU

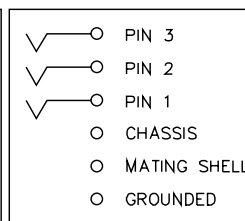
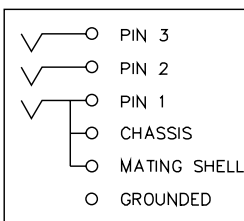
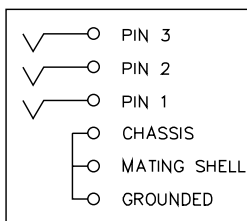
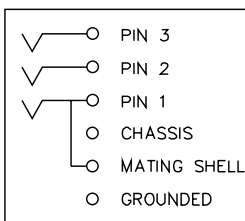



AC SERIES DUAL 1/4" (6.35mm) / XLR

The AC Series C type chassis receptacles feature two connectors in the one space saving housing. A combined XLR female receptacle together with a 6.35mm (1/4") phone jack give the designer more flexibility ensuring premium board space is saved. The new low profile high density C type offers a 15% space saving over the traditional C type. Various configurations are available in either stereo or mono layouts with Vertical, Horizontal Printed Circuit Board or Solder contacts.

Ordering Codes

We have listed the more common ordering codes in each section. For further options please refer to the part number breakdown charts. Please contact us if you need any further assistance.

Features

- Standard or low profile / high density shell design
- Two connectors in the one housing.
- Industry standard PCB footprint layout on standard C type.
- Vertical or Horizontal PCB mounting.
- Bulk packed.
- Positive latch lock system (XLR).

Options

- Solder contacts
- Vertical PCB contacts
- Horizontal PCB contacts
- Bulk Packaging
- Overmoldable connector housing

Simple steps to guide you in using this catalogue

- 1) Identify the product group listed in Contents on page 1 and go directly to that page number.
- 2) Each product group cover page then details information and options available.
- 3) Refer to the product detail pages and identify the product you require pictorially.
- 4) Read the product description column for the products standard features.
- 5) Use variations column to determine your choice.
- 6) Identify part number.
- 7) In the event the particular option you require is not listed please refer to the part number breakdown page at the end of each section.
- 8) Please contact us directly if you have any further problems.



Amphenol

AC SERIES CHASSIS CONNECTORS

C - TYPE LOW PROFILE DUAL JACK / XLR CONNECTORS











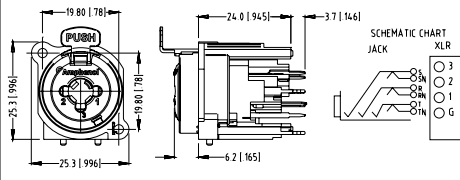

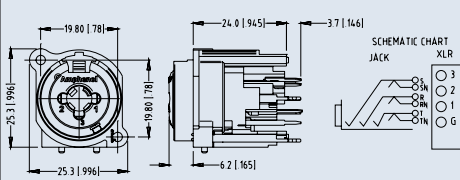
Features:

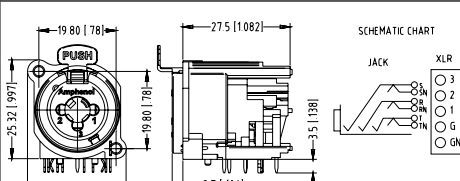
- Two connectors in the one housing.
- Low profile design offers a 15% space saving over the traditional design.
- Vertical or Horizontal PCB mounting.
- Bulk packed in trays, 100 to a box as standard.
- Positive latch lock system (XLR).

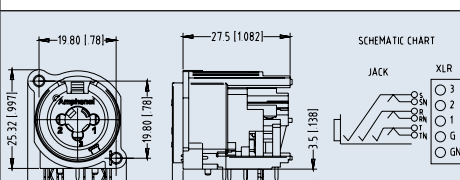
Part Number Breakdown: Page 49
Specifications: Page 51
PCB Footprints: Page 50
Recommended Fastener: Page 132

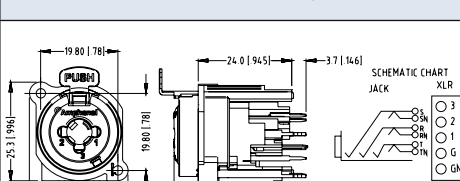
| PRODUCT - FIGURE | DRAWING | Dimensions in mm (inches) | DESCRIPTION | VARIATIONS | PART NUMBER |
|------------------|---------|--|---|--------------------------------|----------------|
| | | 19.80 781 25.30 996 27.5 1082 19.80 781 3.5 138 2.7 106 | Low Profile XLR 3 pole female receptacle with 1/4" stereo jack without switching contact, Horizontal PCB mount, Bulk Pack | Latching | ACJC6AH BULK |
| | | 19.80 781 25.30 996 27.5 1082 19.80 781 3.5 138 2.7 106 | Low Profile XLR 3 pole female receptacle with 1/4" stereo jack without switching contact, Horizontal PCB mount, Bulk Pack | Non-latching, Retention Spring | ACJC6AHL BULK |
| | | 19.80 781 25.31 996 24.0 945 19.80 781 3.7 146 6.2 165 | Low Profile XLR 3 pole female receptacle with 1/4" stereo jack without switching contact, Vertical PCB mount, Bulk Pack | Latching | ACJC6AV2 BULK |
| | | 19.80 781 25.31 996 24.0 945 19.80 781 3.7 146 6.2 165 | Low Profile XLR 3 pole female receptacle with 1/4" stereo jack without switching contact, Vertical PCB mount, Bulk Pack | Non-latching, Retention Spring | ACJC6AV2L BULK |
| | | 19.80 781 25.30 996 27.5 1082 19.80 781 3.5 138 2.7 106 | Low Profile XLR 3 pole female receptacle with 1/4" switching stereo jack, Horizontal PCB mount, Bulk Pack | Latching | ACJC9AH BULK |
| | | 19.80 781 25.30 996 27.5 1082 19.80 781 3.5 138 2.7 106 | Low Profile XLR 3 pole female receptacle with 1/4" switching stereo jack, Horizontal PCB mount, Bulk Pack | Non-latching, Retention Spring | ACJC9AHL BULK |

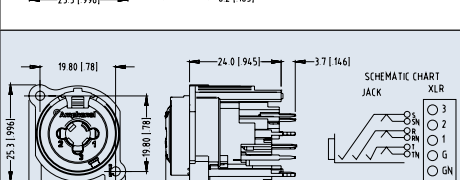
| PRODUCT - FIGURE | DRAWING | Dimensions in mm (inches) | DESCRIPTION | VARIATIONS | PART NUMBER |
|---|---|---------------------------|--|--------------------------------|-----------------|
|  |  | | Low Profile XLR 3 pole female receptacle with 1/4" switching stereo jack, Vertical PCB mount, Bulk Pack | Latching | ACJC9AV2 BULK |
|  |  | | Low Profile XLR 3 pole female receptacle with 1/4" switching stereo jack, Vertical PCB mount, Bulk Pack | Non-latching, Retention Spring | ACJC9AV2L BULK |
|  |  | | Low Profile XLR 3 pole female receptacle with 1/4" switching stereo jack and switching ground contact, Horizontal PCB mount, Bulk Pack | Latching | ACJC10AH BULK |
|  |  | | Low Profile XLR 3 pole female receptacle with 1/4" switching stereo jack and switching ground contact, Horizontal PCB mount, Bulk Pack | Non-latching, Retention Spring | ACJC10AHL BULK |
|  |  | | Low Profile XLR 3 pole female receptacle with 1/4" switching stereo jack and switching ground contact, Vertical PCB mount, Bulk Pack | Latching | ACJC10AV2 BULK |
|  |  | | Low Profile XLR 3 pole female receptacle with 1/4" switching stereo jack and switching ground contact, Vertical PCB mount, Bulk Pack | Non-latching, Retention Spring | ACJC10AV2L BULK |



C - TYPE DUAL JACK / XLR CONNECTORS

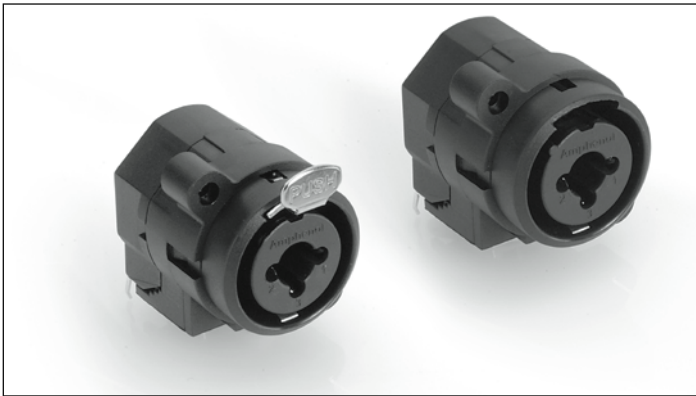









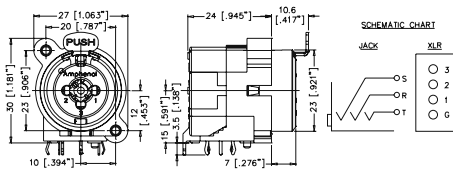

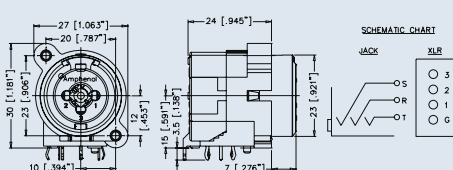

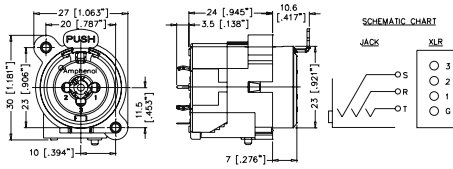
Features:

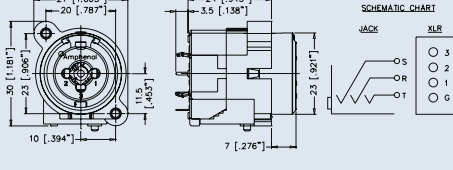

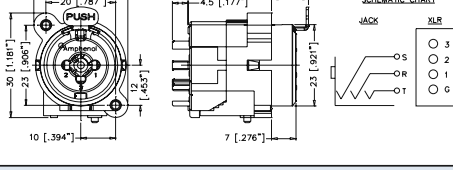

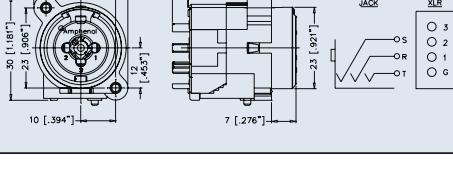
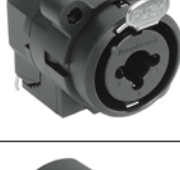
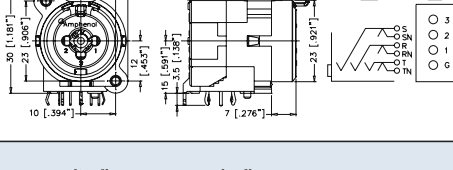

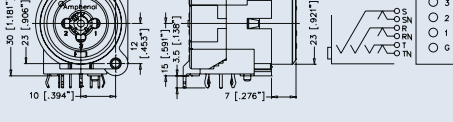



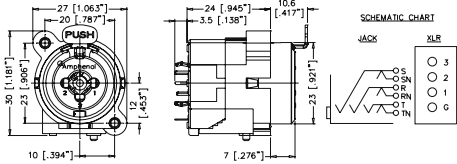

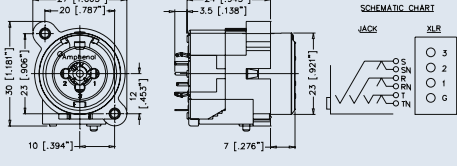

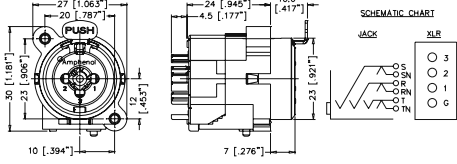
- Two connectors in the one housing.
- Space saving design.
- Industry standard PCB footprint layout.
- Vertical or Horizontal PCB mounting.
- Bulk packed in trays, 100 to a box as standard.
- Positive latch lock system (XLR).

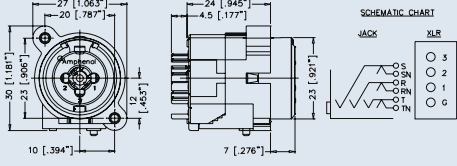
Part Number Breakdown: Page 49
Specifications: Page 51
PCB Footprints: Page 50
Recommended Fastener: Page 132

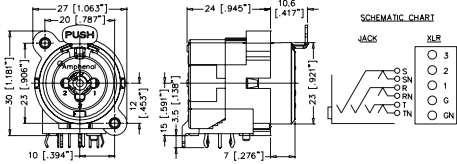
| PRODUCT - FIGURE | DRAWING | Dimensions in mm (inches) | DESCRIPTION | VARIATIONS | PART NUMBER |
|------------------|---------|--|---|--------------------------------|--------------|
| | | 27 [1.063"] 20 [0.787"] 30 [1.181"] 23 [0.906"] 10 [.394"] 12 [.472"] 24 [.945"] 10.6 [.417"] 7 [.276"] 23 [.921"] 15 [.591"] 3.5 [1.35"] | XLR 3 pole female receptacle with 1/4" mono jack without switching contact, Horizontal PCB mount, Bulk Pack | Latching | ACJC5H BULK |
| | | 27 [1.063"] 20 [0.787"] 30 [1.181"] 23 [0.906"] 10 [.394"] 12 [.472"] 24 [.945"] 10.6 [.417"] 7 [.276"] 23 [.921"] 15 [.591"] 3.5 [1.35"] | XLR 3 pole female receptacle with 1/4" mono jack without switching contact, Horizontal PCB mount, Bulk Pack | Non-latching, Retention Spring | ACJC5HL BULK |
| | | 27 [1.063"] 20 [0.787"] 30 [1.181"] 23 [0.906"] 10 [.394"] 12 [.472"] 24 [.945"] 10.6 [.417"] 7 [.276"] 23 [.921"] 15 [.591"] 3.5 [1.35"] | XLR 3 pole female receptacle with 1/4" mono jack without switching contact, Vertical PCB mount, Bulk Pack | Latching | ACJC5V BULK |
| | | 27 [1.063"] 20 [0.787"] 30 [1.181"] 23 [0.906"] 10 [.394"] 11.5 [.453"] 24 [.945"] 3.5 [1.38"] 7 [.276"] 23 [.921"] 15 [.591"] | XLR 3 pole female receptacle with 1/4" mono jack without switching contact, Vertical PCB mount, Bulk Pack | Non-latching, Retention Spring | ACJC5VL BULK |
| | | 27 [1.063"] 20 [0.787"] 30 [1.181"] 23 [0.906"] 10 [.394"] 12 [.472"] 24 [.945"] 10.6 [.417"] 7 [.276"] 23 [.921"] 15 [.591"] 4.5 [1.77"] | XLR 3 pole female receptacle with 1/4" mono jack without switching contact, Solder Contacts, Bulk Pack | Latching | ACJC5S BULK |
| | | 27 [1.063"] 20 [0.787"] 30 [1.181"] 23 [0.906"] 10 [.394"] 12 [.472"] 24 [.945"] 10.6 [.417"] 7 [.276"] 23 [.921"] 15 [.591"] 4.5 [1.77"] | XLR 3 pole female receptacle with 1/4" mono jack without switching contact, Solder Contacts, Bulk Pack | Non-latching, Retention Spring | ACJC5SL BULK |

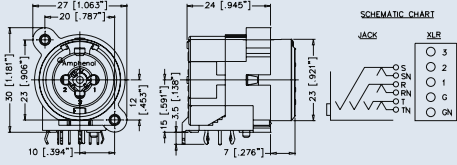
| PRODUCT - FIGURE | DRAWING | Dimensions in mm (inches) | DESCRIPTION | VARIATIONS | PART NUMBER |
|---|---|---------------------------|---|--------------------------------|--------------|
|  |  | | XLR 3 pole female receptacle with 1/4" stereo jack without switching contact, Horizontal PCB mount, Bulk Pack | Latching | ACJC6H BULK |
|  |  | | XLR 3 pole female receptacle with 1/4" stereo jack without switching contact, Horizontal PCB mount, Bulk Pack | Non-latching, Retention Spring | ACJC6HL BULK |
|  |  | | XLR 3 pole female receptacle with 1/4" stereo jack without switching contact, Vertical PCB mount, Bulk Pack | Latching | ACJC6V BULK |
|  |  | | XLR 3 pole female receptacle with 1/4" stereo jack without switching contact, Vertical PCB mount, Bulk Pack | Non-latching, Retention Spring | ACJC6VL BULK |
|  |  | | XLR 3 pole female receptacle with 1/4" stereo jack without switching contact, Solder Contacts, Bulk Pack | Latching | ACJC6S BULK |
|  |  | | XLR 3 pole female receptacle with 1/4" stereo jack without switching contact, Solder Contacts, Bulk Pack | Non-latching, Retention Spring | ACJC6SL BULK |
|  |  | | XLR 3 pole female receptacle with 1/4" switching stereo jack, Horizontal PCB mount, Bulk Pack | Latching | ACJC9H BULK |
|  |  | | XLR 3 pole female receptacle with 1/4" switching stereo jack, Horizontal PCB mount, Bulk Pack | Non-latching, Retention Spring | ACJC9HL BULK |

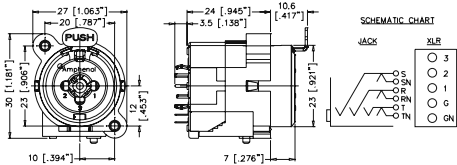

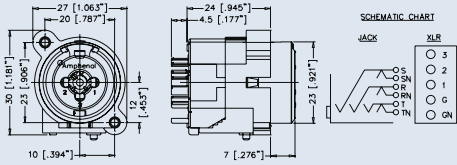
| PRODUCT - FIGURE | DRAWING | Dimensions in mm (inches) | DESCRIPTION | VARIATIONS | PART NUMBER |
|---|---|---------------------------|--|--------------------------------|---------------|
|  |  | | XLR 3 pole female receptacle with 1/4" switching stereo jack, Vertical PCB mount, Bulk Pack | Latching | ACJC9V BULK |
|  |  | | XLR 3 pole female receptacle with 1/4" switching stereo jack, Vertical PCB mount, Bulk Pack | Non-latching, Retention Spring | ACJC9VL BULK |
|  |  | | XLR 3 pole female receptacle with 1/4" switching stereo jack, Solder Contacts, Bulk Pack | Latching | ACJC9S BULK |
|  |  | | XLR 3 pole female receptacle with 1/4" switching stereo jack, Solder Contacts, Bulk Pack | Non-latching, Retention Spring | ACJC9SL BULK |
|  |  | | XLR 3 pole female receptacle with 1/4" switching stereo jack and switching ground contact, Horizontal PCB mount, Bulk Pack | Latching | ACJC10H BULK |
|  |  | | XLR 3 pole female receptacle with 1/4" switching stereo jack and switching ground contact, Horizontal PCB mount, Bulk Pack | Non-latching, Retention Spring | ACJC10HL BULK |
|  |  | | XLR 3 pole female receptacle with 1/4" switching stereo jack and switching ground contact, Vertical PCB mount, Bulk Pack | Latching | ACJC10V BULK |
|  |  | | XLR 3 pole female receptacle with 1/4" switching stereo jack and switching ground contact, Vertical PCB mount, Bulk Pack | Non-latching, Retention Spring | ACJC10VL BULK |

| PRODUCT - FIGURE | DRAWING | DESCRIPTION | VARIATIONS | PART NUMBER |
|------------------|--|---|--------------------------------|---------------|
| | <p>Dimensions in mm (inches)</p> <p>SCHEMATIC CHART</p> <p>JACK XLR</p> <ul style="list-style-type: none"> ○ 3 ○ 2 ○ 1 ○ G ○ GN | XLR 3 pole female receptacle with 1/4" switching stereo jack and switching ground contact, Solder Contacts, Bulk Pack | Latching | ACJC10S BULK |
| | <p>Dimensions in mm (inches)</p> <p>SCHEMATIC CHART</p> <p>JACK XLR</p> <ul style="list-style-type: none"> ○ 3 ○ 2 ○ 1 ○ G ○ GN | XLR 3 pole female receptacle with 1/4" switching stereo jack and switching ground contact, Solder Contacts, Bulk Pack | Non-latching, Retention Spring | ACJC10SL BULK |

PART NUMBER BREAKDOWN

AC SERIES THERMOPLASTIC C TYPE

E. G. **ACJC5HL BULK**
AC (Series Prefix), **JC** Jack/Connector XLR, **5** Mono, **H**orizontal Printed Circuit Board, **L**atchless, **BULK** Packaged.

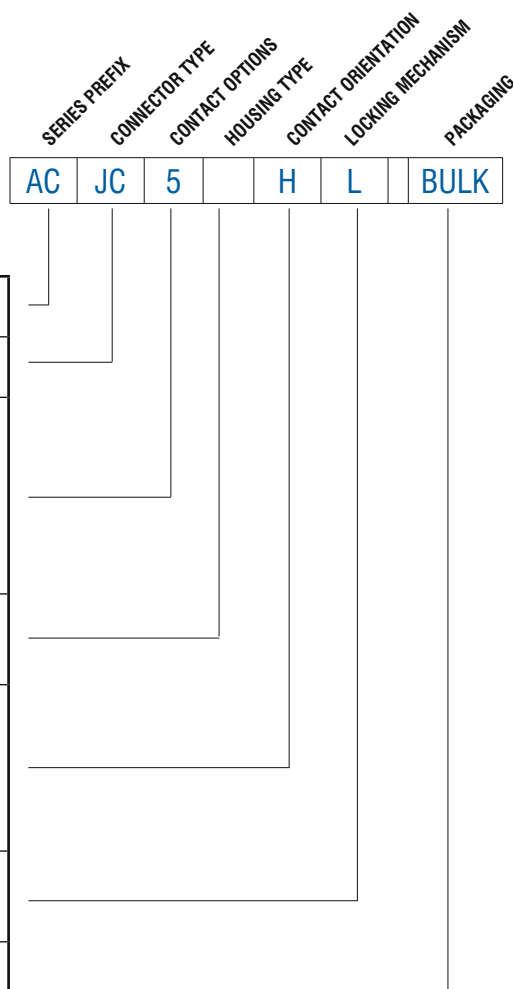

| | | | |
|--------------------------|-------|---|---|
| SERIES PREFIX | AC | = | Series Prefix |
| CONNECTOR TYPE | JC | = | Jack / Connector XLR |
| CONTACT OPTIONS | 5 | = | Mono, Non Switching, XLR Grounded |
| | 6 | = | Stereo, Non Switching, XLR Grounded |
| | 9 | = | Stereo, Switching, XLR Grounded |
| | 10 | = | Stereo, Switching, XLR with Ground Switch |
| HOUSING TYPE | Blank | = | Standard |
| | A | = | Low Profile / High Density |
| CONTACT TYPE | V | = | Vertical Printed Circuit Board |
| | V2 | = | Vertical Printed Circuit Board (24mm) |
| | H | = | Horizontal Printed Circuit Board |
| | S | = | Solder Contacts |
| LOCKING MECHANISM | Blank | = | Latching |
| | L | = | Latchless |
| PACKAGING | Blank | = | Individual Bags |
| | BULK | = | Bulk Packed |

AC SERIES C TYPE SERIES

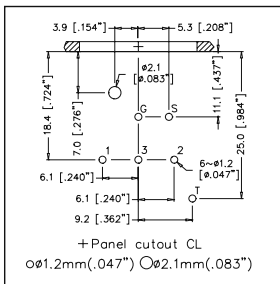

ACJCSH & ACJCSHL

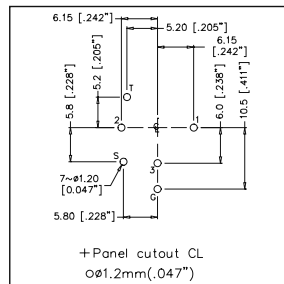

ACJC5V & ACJC5VL

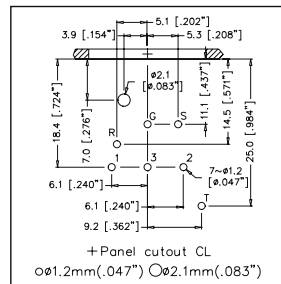

ACJC6H & ACJC6HL

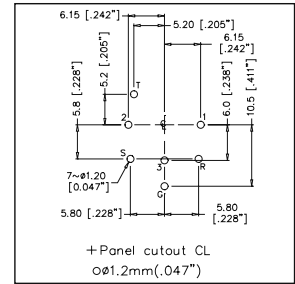

ACJC6V & ACJC6VL

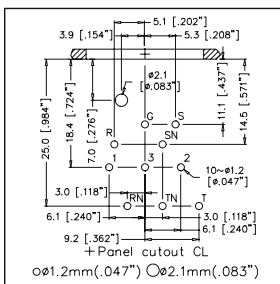

ACJC9H & ACJC9HL

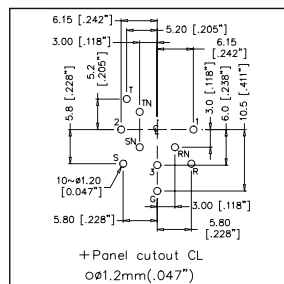

ACJC9V & ACJC9VL

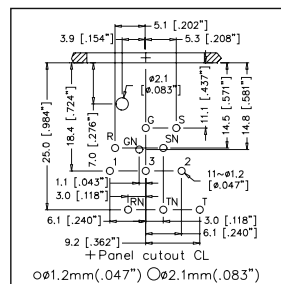

ACJC10H & ACJC10HL

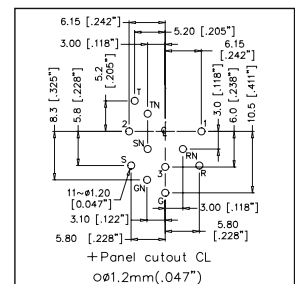

ACJC10V & ACJC10VL

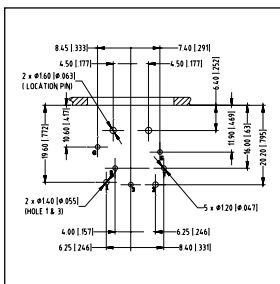

ACJC6AH & ACJC6AHL

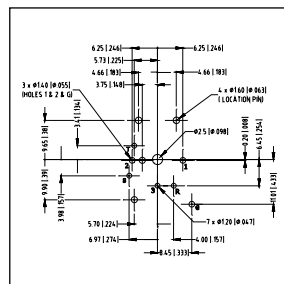

ACJC6AV2 & ACJC6AV2L

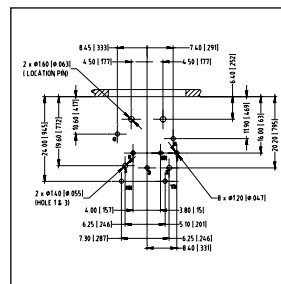

ACJC9AH & ACJC9AHL

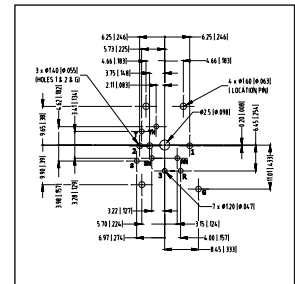

ACJC9AV2 & ACJC9AV2L

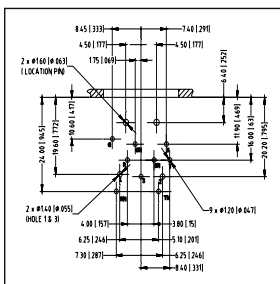

ACJC10AH & ACJC10AHL

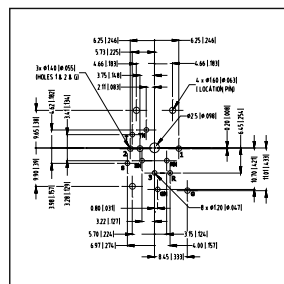

ACJC10AV2 & ACJC10AV2L

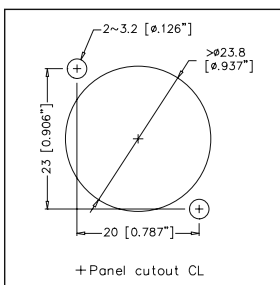

C TYPE PANEL CUTOUT

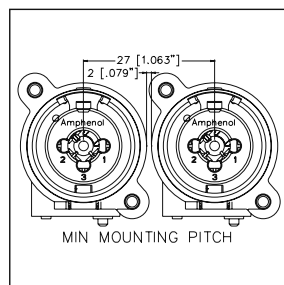

C TYPE MOUNTING PITCH

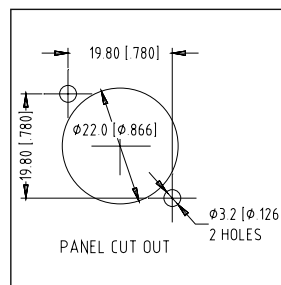

C TYPE LOW PROFILE PANEL CUTOUT

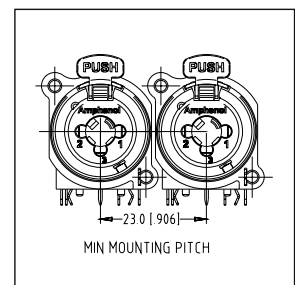

C TYPE LOW PROFILE MOUNTING PITCH

STANDARD DATA C TYPE CHASSIS RECEPTACLES

| | | VALUE | |
|-----------------------------------|--|--|--|
| | | LOW PROFILE TYPE | STANDARD C TYPE |
| GENERAL CHARACTERISTICS | Number of contacts | 5, 6, 9 or 10 | |
| | Termination | Printed Circuit Board (PCB) | Printed Circuit Board (PCB) or Solder Bucket |
| | Flammability | UL 94HB | |
| | Environmental | Complies with EU RoHS 2 Directive 2011/65/EU | |
| ELECTRICAL CHARACTERISTICS | Service Voltage RMS | 50V | |
| | Test Voltage AC RMS | 1500V | |
| | Current carrying capacity | 7.5A | |
| | Typical Contact Resistance | ≤50mΩ | |
| | Insulation Resistance (initial) | > 0.5GΩ | |
| | Insulation Resistance (after damp heat test) | > 0.2GΩ | |
| CLIMATIC CHARACTERISTICS | Protection Class | IP40 | |
| | Operating Temperature | -25 °C to +70 °C | |
| MECHANICAL CHARACTERISTICS | Weight** | 9.2g (0.02lb) | 14g (0.030lb) |
| | Retention Spring separating force | ≥20N | |
| | Mounting Screw torque max. | 1.5Nm | |
| | Mechanical Operations | 1500 mating cycles | |
| | Fastening*** | Self-Tapping PT screw with thread 2.9 x 1.06 and of Tri-rondular configuration | |
| MATERIALS | Connector Shell | PA6.6 + 30% glass fibre reinforced, UL94HB | PA6.6 + 20% glass fibre reinforced, UL94HB |
| | Shell Finish | | Black |
| | Insulators | PA6.6 glass fibre reinforced, UL94HB | PA6.6 + 20% glass fibre reinforced, UL94HB |
| | XLR Contact | | |
| | Material | Bronze | |
| | Plating | Gold over Nickel plated | |
| | Jack Contact | | |
| | Material | Bronze | Brass |
| Plating | Gold over Nickel plated | Silver over Copper plated | |
| Latch lock and Spring | Nickel Plated | | |
| Ground element | Nickel Plated | Silver over Copper plated | |

**Approximate weight in grams not including packaging. Please contact us for exact weight for shipping purposes.

***Refer to Page 132

Rev 6 - 03/2013

SP/HP/EP/ AP SERIES HIGH POWER / LOUDSPEAKER CONNECTORS



SP Series

The SP Series are available in 2 or 4 pole chassis mount connectors. The durable thermoplastic housings are fitted with high power contacts to ensure optimal current carrying capacity. Completely intermatable with industry standard loudspeaker connections.

Features

- High current contacts for distortion free signal.
- Cost effective durable thermoplastic shell
- Available in 2 and 4 contact arrangements.
- Overmolded cable support boot or PG gland with or without cable support strain relief.
- Quick release, vibration resistant latch lock.
- UL, cUL recognized components (File no. E339831)
- Precision machined contacts
- Thermoplastic shell

Options

- Solder termination / Tab or Printed Circuit Board versions, Screw Terminals
- Nickel Plated Zinc Alloy shell
- Black finished Zinc Alloy shell

HP Series

The HP Series connectors are suitable for power applications where a latch locking connector is required. They are rated at 25A / 250Vac.

Features

- Quick release, vibration resistant latch lock.
- Power connectors colour coded and keyed for power-in (Blue) and power-out (Grey)
- UL, cUL recognized components (File no. E339831)
- Precision machined contacts

EP Series

The EP Series incorporates a rugged zinc diecast shell to give it maximum durability when used in demanding situations. The EP cable connector cable flex relief design minimises cable bend stress at point of entry into the connector housing.

Features

- High current contacts for distortion free signal.
- Tough, durable zinc diecast shell
- Cable clamp capable of supporting cables from 9mm (0.35") to 16mm (0.63") in diameter.
- Quick release, vibration resistant latch lock.
- AP & EP series are completely intermatable.
- Precision machined contacts

Options

- Nickel Plated Zinc Alloy shell
- Black finished Zinc Alloy shell
- Available in 3, 4, 5, 6 and 8 contact arrangements

AP Series

The AP Series Shell is manufactured from tough, durable thermoplastic, and ideal for fixed indoor installations. Both the EP and AP Series utilise the same contact and insulator components.

Features

- High current contacts for distortion free signal.
- Cost effective durable thermoplastic shell
- Quick release, vibration resistant latch lock.
- AP & EP series are completely intermatable.
- Precision machined contacts
- Thermoplastic shell

Options

- Available in 4, 5, 6, and 8 contact arrangements.

Ordering Codes

We have listed the more common ordering codes in each section. Please contact us if you need any further assistance.

Simple steps to guide you in using this catalogue

- 1) Identify the product group listed in Contents on page 1 and go directly to that page number.
- 2) Each product group cover page then details information and options available.
- 3) Refer to the product detail pages and identify the product you require pictorially.
- 4) Read the product description column for the products standard features.
- 5) Use variations column to determine your choice.
- 6) Identify part number.
- 7) In the event the particular option you require is not listed please refer to the part number breakdown page at the end of each section.
- 8) Please contact us directly if you have any further problems.



Amphenol's range of loudspeaker connectors have been further enhanced with the introduction of the SP Series. Designed to complement the popular EP/AP Series, we now offer a range of loudspeaker connectors to suit most applications. SP Series chassis connectors are available in industry standard PCB footprints with solder tabs. SP Series cable plugs are available with screw or solder terminals.

Features:

- Quick release, vibration resistant latch lock
- 2 or 4 pole
- Solder tabs, PCB Contacts, Solder or Screw Terminals
- Chuck type or PG Gland cable clamp
- Various mounting hole options
- 30A Current rating
- Thermoplastic or Metal housing (Cable Plugs)
- UL, cUL recognized components (File no. E339831)
- Industry standard mating



Part Number Breakdown: Page 57
PCB Footprints: Page 59

Specifications: Page 61
Assembly Instructions: 60

| PRODUCT - FIGURE | DRAWING | Dimensions in mm (inches) | DESCRIPTION | CONTACT TYPE | SHELL COLOUR | PART NUMBER |
|------------------|---------|---------------------------|---|--------------|--------------|-------------|
| | | | 2 pole, Cable connector, Thermoplastic shell, Blue sleeve | Screw | Black | SP-2-F |
| | | | | Solder | Black | SP-2-FS |
| | | | 2 pole, Cable connector, Thermoplastic shell, Blue sleeve, PG Gland | Screw | Black | SP-2-FG |
| | | | | Solder | Black | SP-2-FSG |
| | | | 2 pole, Cable connector, Thermoplastic shell, Blue sleeve, PG Gland strain relief | Screw | Black | SP-2-FL |
| | | | | Solder | Black | SP-2-FSL |
| | | | 2 pole, Cable connector, Metal shell, Blue sleeve | Screw | Nickel | SP-2-FN |
| | | | | Solder | Nickel | SP-2-FNS |
| | | | | Screw | Black | SP-2-FB |
| | | | | Solder | Black | SP-2-FBS |
| | | | 2 pole, Cable connector, Metal shell, Blue sleeve, PG Gland | Screw | Nickel | SP-2-FNG |
| | | | | Solder | Nickel | SP-2-FNSG |
| | | | | Screw | Black | SP-2-FBG |
| | | | | Solder | Black | SP-2-FBSG |
| | | | 2 pole, Cable connector, Metal shell, Blue sleeve, PG Gland strain relief | Screw | Nickel | SP-2-FNL |
| | | | | Solder | Nickel | SP-2-FNSL |
| | | | | Screw | Black | SP-2-FBL |
| | | | | Solder | Black | SP-2-FBSL |









| PRODUCT - FIGURE | DRAWING | DESCRIPTION | CONTACT TYPE | SHELL COLOUR | PART NUMBER |
|------------------|----------------------------------|---|--------------|--------------|-------------|
| | <p>Dimensions in mm (inches)</p> | 4 pole, Cable connector, Thermoplastic black shell, Blue sleeve | Screw | Black | SP-4-F |
| | | | Solder | Black | SP-4-FS |
| | | 4 pole, Cable connector, Thermoplastic black shell, Blue sleeve, PG Gland | Screw | Black | SP-4-FG |
| | | | Solder | Black | SP-4-FSG |
| | | 4 pole, Cable connector, Thermoplastic black shell, Blue sleeve, PG Gland strain relief | Screw | Black | SP-4-FL |
| | | | Solder | Black | SP-4-FSL |
| | | 4 pole, Cable connector, Metal shell, Blue sleeve | Screw | Nickel | SP-4-FN |
| | | | Solder | Nickel | SP-4-FNS |
| | | | Screw | Black | SP-4-FB |
| | | | Solder | Black | SP-4-FBS |
| | | 4 pole, Cable connector, Metal shell, Blue sleeve, PG Gland | Screw | Nickel | SP-4-FNG |
| | | | Solder | Nickel | SP-4-FNSG |
| | | | Screw | Black | SP-4-FBG |
| | | | Solder | Black | SP-4-FBSG |
| | | 4 pole, Cable connector, Metal shell, Blue sleeve, PG Gland strain relief | Screw | Nickel | SP-4-FNL |
| | | | Solder | Nickel | SP-4-FNSL |
| | | | Screw | Black | SP-4-FBL |
| | | | Solder | Black | SP-4-FBSL |

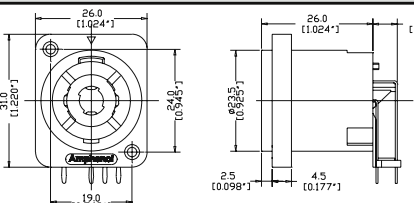

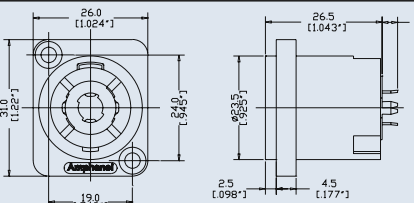
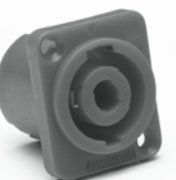
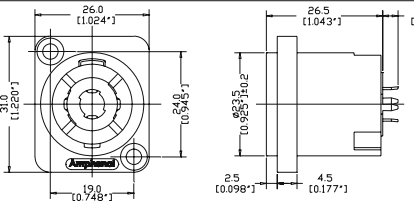
| PRODUCT - FIGURE | DRAWING | Dimensions in mm (inches) | DESCRIPTION | VARIATIONS | PART NUMBER |
|------------------|---------|---|---|------------|-------------|
| | | 26.0 (1.024") 31.0 (1.220") 24.0 (0.945") 19.0 (0.748") 28.2 (1.110") 4.3 (0.169") ø23.5 (0.925") 2.5 (0.098") 4.5 (0.177") | 2 pole, D flange, Thru holes, Solder tabs 3/16" | Black | SP-2-MD |
| | | 26.0 (1.024") 31.0 (1.220") 24.0 (0.945") 19.0 (0.748") 26.0 (1.024") 5.7 (0.224") ø23.5 (0.925") 2.5 (0.098") 4.5 (0.177") | 2 pole, D flange, Thru holes, Horizontal PCB | Black | SP-2-MDH |
| | | 26.0 (1.024") 31.0 (1.220") 24.0 (0.945") 19.0 (0.748") 26.5 (1.043") 3.5 (0.138") ø23.5 (0.925") 2.5 (0.098") 4.5 (0.177") | 2 pole, D flange, Thru holes, Vertical PCB | Black | SP-2-MDV |
| | | 26.0 (1.024") 31.0 (1.220") 24.0 (0.945") 19.0 (0.748") 28.2 (1.110") 4.3 (0.169") ø23.5 (0.925") 2.5 (0.098") 4.5 (0.177") | 4 pole, D flange, Thru holes, Solder tabs 3/16" | Black | SP-4-MD |
| | | 26.0 (1.024") 31.0 (1.220") 24.0 (0.945") 19.0 (0.748") 28.2 (1.110") 4.3 (0.169") ø23.5 (0.925") 2.5 (0.098") 4.5 (0.177") | 4 pole, D flange, Thru holes, Solder tabs 3/16" | Grey | SP-4-MD-8 |
| | | 26.0 (1.024") 31.0 (1.220") 24.0 (0.945") 19.0 (0.748") 28.2 (1.110") 4.3 (0.169") ø23.5 (0.925") 2.5 (0.098") 4.5 (0.177") | 4 pole, D flange, Self Tapping holes, Solder tabs 3/16" | Black | SP-4-MDT |
| | | 26.0 (1.024") 31.0 (1.220") 24.0 (0.945") 19.0 (0.748") 26.0 (1.024") 5.7 (0.224") ø23.5 (0.925") 2.5 (0.098") 4.5 (0.177") | 4 pole, D flange, Thru holes, Horizontal PCB | Black | SP-4-MDH |
| | | 26.0 (1.024") 31.0 (1.220") 24.0 (0.945") 19.0 (0.748") 26.0 (1.024") 5.7 (0.224") ø23.5 (0.925") 2.5 (0.098") 4.5 (0.177") | 4 pole, D flange, Self Tapping holes, Horizontal PCB | Grey | SP-4-MDHT-8 |

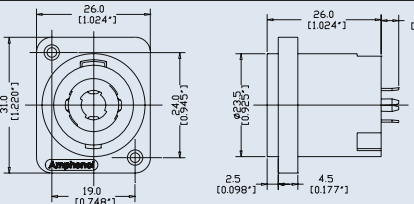

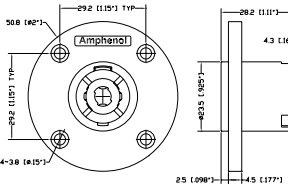
| PRODUCT - FIGURE | | DESCRIPTION | VARIATIONS | PART NUMBER |
|---|---|--|------------|-------------|
|  |  | 4 pole, D flange, Self Tapping holes, Horizontal PCB | Black | SP-4-MDHT |
|  |  | 4 pole, D flange, Thru holes, Vertical PCB | Black | SP-4-MDV |
|  |  | 4 pole, D flange, Thru holes, Vertical PCB | Red | SP-4-MDV-2 |
|  |  | 4 pole, D flange, Self Tapping holes, Vertical PCB | Grey | SP-4-MDVT-8 |
|  |  | 4 pole, EP flange, Thru holes, Solder tabs 3/16" | Black | SP-4-MC |



PART NUMBER BREAKDOWN

SP SERIES - CABLE CONNECTORS

E. G . **SP-4-FNSG**
SP (Series Prefix), **4** contacts, **F** (Cable Connector), **N** (Metal Shell Nickel Finish),
S (Solder Terminals), **G** (PG Gland)

| | |
|-----------------------|--|
| SERIES PREFIX | SP = Series Prefix |
| CONTACT LAYOUT | 2 = 2 Contacts 4 = 4 Contacts |
| GENDER | F = Cable Connector |
| SHELL FINISH | Blank = Thermoplastic - Black N = Metal - Nickel Finish B = Metal - Black Finish |
| TERMINATION | Blank = Screw Terminals S = Solder Terminals |
| BACKSHELL TYPE | Blank = Standard G = PG Gland L = PG Gland Strain Relief |
| PACKAGING | Blank = Individual Bags B = Bulk Packed |

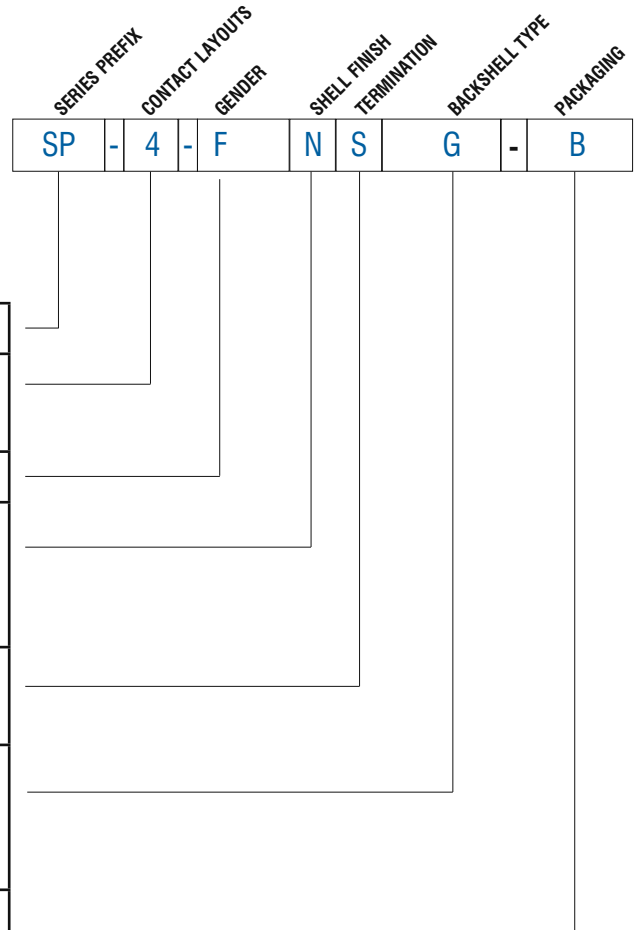

PART NUMBER BREAKDOWN

SP SERIES - CHASSIS CONNECTORS

E. G. **SP-4-MDHT-8B**
SP (Series Prefix), **4** contacts, **M**(Chassis Connector), **D** (D Shell), **H**orizontal Printed Circuit Board, Self **T**apping mounting holes - **8** (Grey), **B**ulk Packaged.

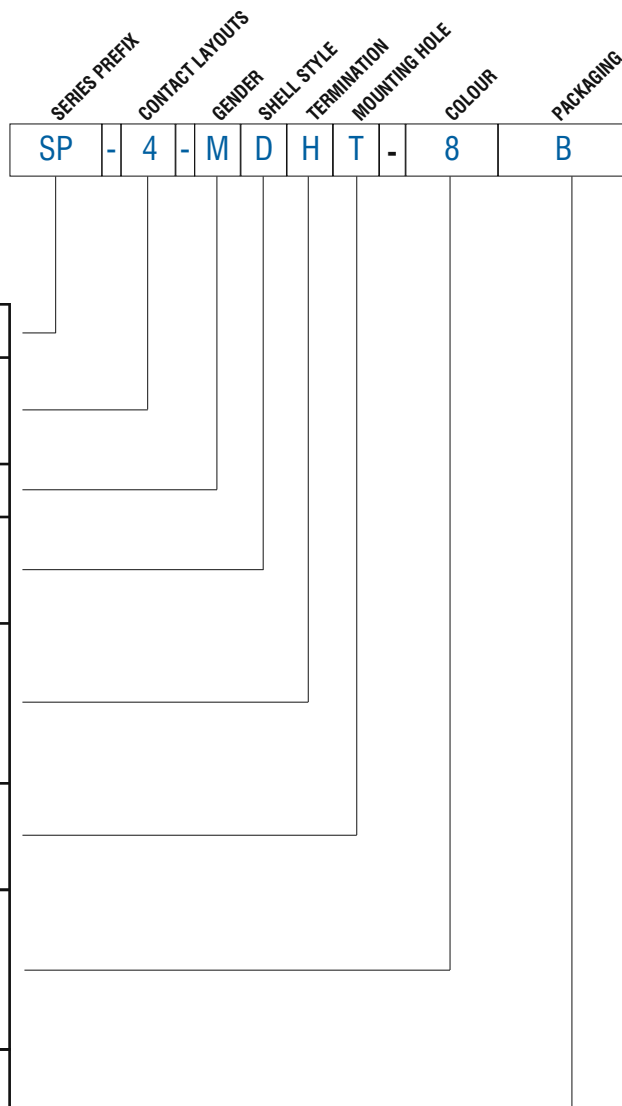

| | | | |
|-----------------------|-------|---|----------------------------------|
| SERIES PREFIX | SP | = | Series Prefix |
| CONTACT LAYOUT | 2 | = | 2 Contacts |
| | 4 | = | 4 Contacts |
| GENDER | M | = | Chassis Connector |
| SHELL STYLE | D | = | Standard 'D' Type flange |
| | C | = | EP Series Circular flange |
| TERMINATION | Blank | = | Solder tabs - 3/16" terminals |
| | V | = | Vertical Printed Circuit Board |
| | H | = | Horizontal Printed Circuit Board |
| MOUNTING HOLE | Blank | = | Thru Hole |
| | T | = | Self Tapping |
| SHELL COLOUR | Blank | = | Black |
| | 2 | = | Red |
| | 8 | = | Grey |
| PACKAGING | Blank | = | Individual Bags |
| | B | = | Bulk Packed |



SP SERIES

SP-2-MDH

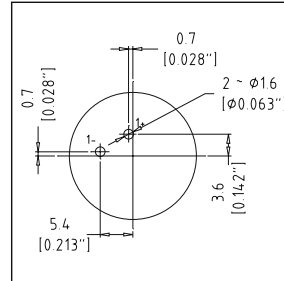
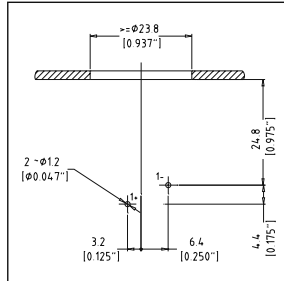

SP-2-MDV

SP-4-MDH
SP-4-MDHT-8
SP-4-MDHT

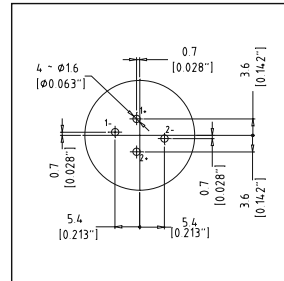
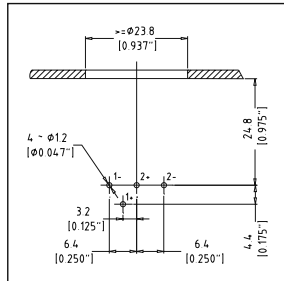

SP-4-MDV
SP-4-MDV-2
SP-4-MDVT-8

SP SERIES PANEL CUTOUT

SP-2-MD** *
SP-4-MD** *
_

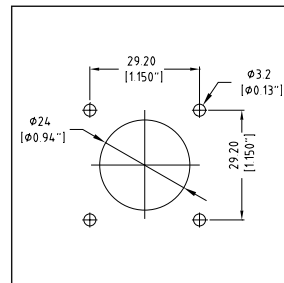
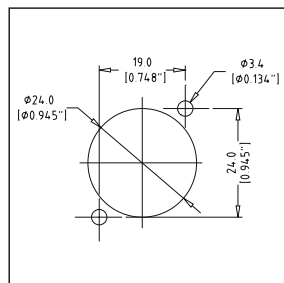

SP-4-MC



PI 1070 ASSEMBLY INSTRUCTIONS

SP SERIES CABLE CONNECTOR

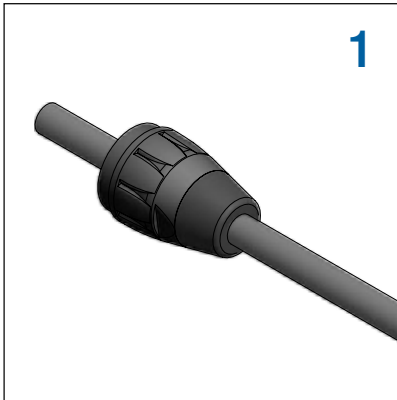

1

Slide the nut onto the cable

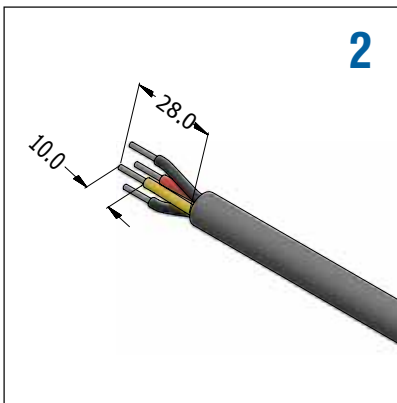

2

Strip the cable and twist the conductors.

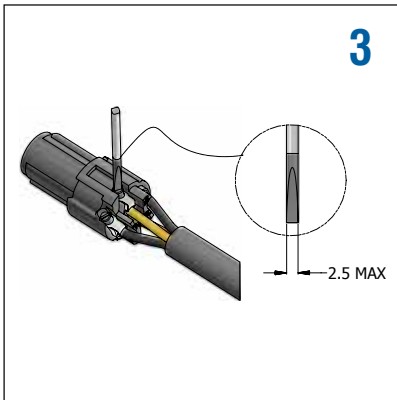

3

Insert the conductors into the rear of contacts on the insert. Tighten the screws to 0.35Nm (3.0 lb-in) using a flat screwdriver with tip width of 2.5mm max.

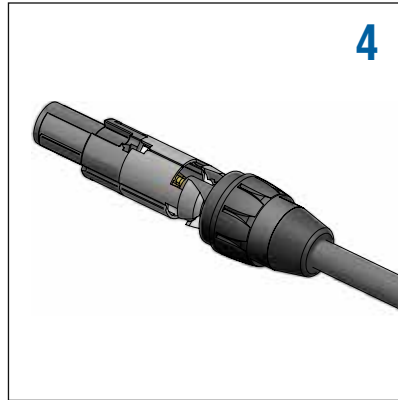

4

Install the cable clamp, flush to the insert making sure to align the slot as shown in the picture.

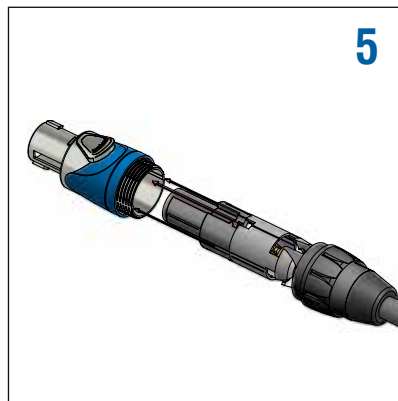

5

Orientate the insert and cable clamp as shown then push all together into the shell.

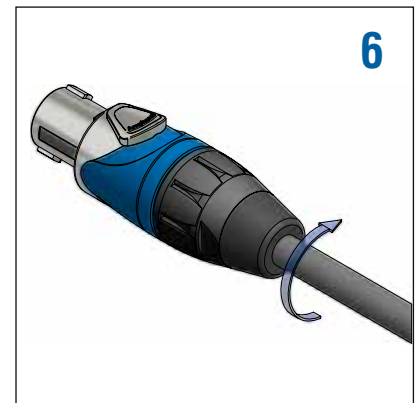

6

Thread the nut onto the shell to activate the cable clamp and close the connector assembly.

STANDARD DATA SP SERIES CONNECTORS

| | | VALUE |
|---|---|--|
| GENERAL CHARACTERISTICS | Number of contacts | 2 or 4 |
| | Termination (Chassis) | Printed Circuit Board (PCB) or Solder Tabs 3/16" |
| | Termination (Cable Plugs) | Screw or Solder Terminals |
| | Flammability | UL94HB |
| | Environmental | Complies with EU RoHS 2 Directive 2011/65/EU |
| ELECTRICAL CHARACTERISTICS | Service Voltage RMS | 133V ¹⁾ |
| | Test Voltage AC RMS | 1500V |
| | Current carrying capacity | 30A |
| | Typical Contact Resistance | ≤3mΩ |
| | Insulation Resistance (initial) | ≥2GΩ |
| | Insulation Resistance (after damp heat test) | ≥1GΩ |
| CLIMATIC CHARACTERISTICS | Protection Class | IP54 |
| | Operating Temperature | -25 °C to +75 °C (-13°F to +167°F) |
| MECHANICAL CHARACTERISTICS | Weight** - Chassis Connectors | 12g (0.026lb) |
| | Weight** - Cable Plug - Thermoplastic - Metal | 44g (0.097lb) |
| | | 65g (0.143lb) |
| | Weight** - Cable Plug PG - Thermoplastic - Metal | 44g (0.097lb) |
| | | 65g (0.143lb) |
| | Weight** - Cable Plug PG S/Relief - Thermoplastic - Metal | 68g (0.150lb) |
| | | 89g (0.196lb) |
| | Typical Cable retention force | 200N (Subject to cable material and O.D.) |
| Cable O.D range - Chuck Clamp - PG16 Gland - PG16 Gland S/Relief | 2 pole 5-10mm (0.19" - 0.39") | 4 pole 9-14mm (0.35" - 0.55") |
| | 6-12mm (0.23" - 0.47") | 8-14mm (0.31" - 0.55") |
| | 9-14mm (0.35" - 0.55") | 9-14mm (0.35" - 0.55") |
| | Conductor Size - Screw Terminals - Solder Bucket | 1.5mm ² - 4mm ² (AWG16 - AWG12) 1.5mm ² - 6mm ² (AWG16 - AWG10) |
| MATERIALS | Connector Shell / Finish - Cable Plug Thermoplastic - Cable Plug Metal | PA66 GF30 / Black Diecast Zinc Alloy / Nickel or Black |
| | Insulators - Chassis - Cable Plugs | PA66 GF20 PA66 GF30 |
| | Cable Boot / Backshell | Santoprene / PA6 GF 15 |
| | Cable Clamp (Chuck) | P.O.M |
| | Cable Clamp (PG) | Polyamide / EPDM |
| | Sleeve | PBT |
| | Contact Chassis - Material / Plating Contact Cable Plug - Material / Plating | Phosphor Bronze / Silver Brass / Silver |



Rev 5 - 03/2013

**Approximate weight in grams not including packaging. Please contact us for exact weight for shipping purposes.

¹⁾Not suitable for domestic applications above 50V

Amphenol

EP / AP / SP / HP SERIES

HP POWER CONNECTORS



HP Series connectors are suitable for AC power supply where a latch locking connector is required. They are rated at 25 A / 250 Vac. Connectors are keyed and colour coded for power-in (Blue) and power-out (Grey).

⚠ THE HP SERIES OF CONNECTORS ARE NOT DESIGNED TO BE "HOT PLUGGED" AND SO ARE WITHOUT "BREAKING CAPACITY". IN OTHER WORDS, THE CONNECTORS SHOULD NOT BE CONNECTED OR DISCONNECTED LIVE OR WHEN UNDER LOAD

Features:

- Quick release, vibration resistant latch lock
- 3 pole
- Screw Terminals or Solder Tab 3/16"
- Chuck type cable clamp
- 25A Current rating
- Thermoplastic housing
- Industry standard mating
- UL, cUL recognized components (File no. E339831)



Specifications: Page 63

| PRODUCT - FIGURE | DRAWING | Dimensions in mm (inches) | DESCRIPTION | CONTACT TYPE | SHELL COLOUR | PART NUMBER |
|------------------|---------|---------------------------|---|------------------|--------------|-------------|
| | | | 3 pole, Cable connector, Thermoplastic shell, Blue sleeve, keyed for power-in | Screw | Blue | HP-3-F |
| | | | 3 pole, Cable connector, Thermoplastic shell, Grey sleeve, keyed for power-out | Screw | Grey | HP-3-FG |
| | | | 3 pole, Chassis connector, Thermoplastic shell, Blue, keyed for power-in | Solder Tab 3/16" | Blue | HP-3-MD |
| | | | 3 pole, Chassis connector, Thermoplastic shell, Grey, keyed for power-out | Solder Tab 3/16" | Grey | HP-3-MDG |
| | | | 3 pole, Chassis connector, Thermoplastic shell, Blue, keyed for power-in, without insulation divider | Solder Tab 3/16" | Blue | HP-3-MDW |
| | | | 3 pole, Chassis connector, Thermoplastic shell, Grey, keyed for power-out, without insulation divider | Solder Tab 3/16" | Grey | HP-3-MDGW |

STANDARD DATA HP SERIES CONNECTORS

| | | VALUE |
|-----------------------------------|--|---|
| GENERAL CHARACTERISTICS | Number of contacts | 2 + PE |
| | Termination | Screw or Solder Tab 3/16" |
| | Flammability | UL94V-0 |
| | Environmental | Complies with EU RoHS 2 Directive 2011/65/EU |
| ELECTRICAL CHARACTERISTICS | Rated Operating Voltage | 250VAC |
| | Test Voltage AC RMS | 1500V |
| | Current carrying capacity | 25A |
| | Typical Contact Resistance | ≤3mΩ |
| | Insulation Resistance (initial) | ≥2GΩ |
| | Insulation Resistance (after damp heat test) | ≥1GΩ |
| CLIMATIC CHARACTERISTICS | Protection Class | IP54 |
| | Operating Temperature | -25 °C to +75 °C (-13°F to +167°F) |
| MECHANICAL CHARACTERISTICS | Weight** - Chassis Connector - Cable Plug | 12g (0.026lb) 32g (0.070lb) |
| | Typical Cable retention force | 200N (Subject to cable material and O.D.) |
| | Cable O.D range - Blue Chuck Clamp - Black Chuck Clamp | 5mm - 7.5mm (0.19" - 0.29") 7.5mm - 15mm (0.29" - 0.59") |
| | Conductor Size - Screw Terminals | 2.5mm ² (AWG14) |
| | MATERIALS | Connector Shell / Finish |
| | Insulators | PA66 GF30 |
| | Cable Boot / Backshell | Santoprene / PBT |
| | Cable Clamp (Chuck) | P.O.M |
| | Contact Plug - Material / Plating | Brass / Silver |
| | Contact Chassis - Material / Plating | Phosphor Bronze / Silver |

Rev 3 - 05/2015



**Approximate weight in grams not including packaging. Please contact us for exact weight for shipping purposes.





The EP Series has set the standard in high performance speaker connectors. Apart from its durability and strength, it offers consistent superior power handling capabilities.

Features:

- Solder Bucket connections.
- Precision machined contacts.
- Diecast Metal Housings
- High current contacts
- Male and female cable and chassis connectors available.

Options: Black Finish Shell
Panel Cutouts: Page 68

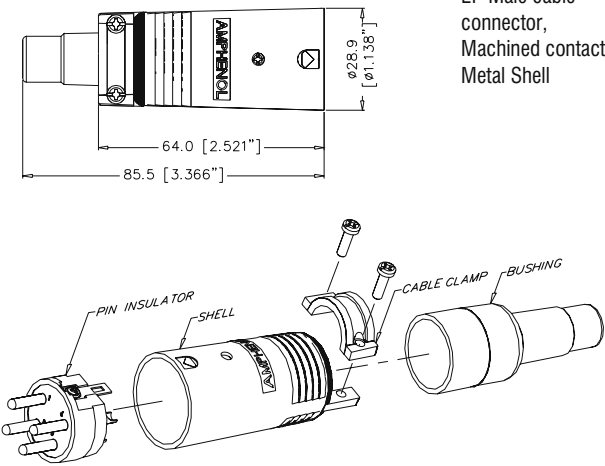
Specifications: Page 67

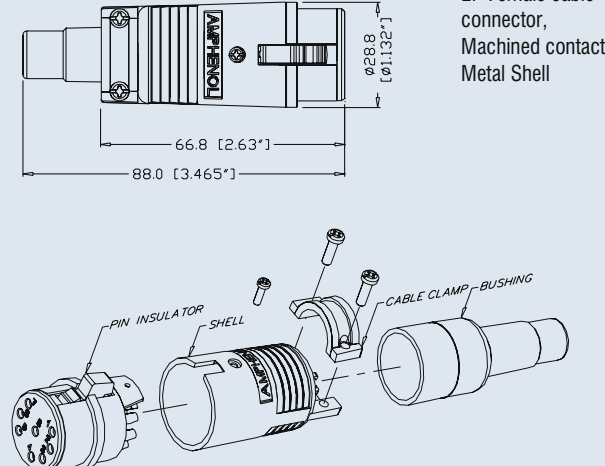
| PRODUCT - FIGURE | DRAWING | DESCRIPTION | VARIATIONS | PART NUMBER |
|---|--|--|----------------------|-------------|
|  <p>ISO ASSEMBLY OF EP MALE</p> | <p>Dimensions in mm (inches)</p>  | <p>EP Male cable connector, Machined contacts, Metal Shell</p> | 3 pole nickel finish | EP-3-12 |
| | | | 3 pole black finish | EP-3-12B |
| | | | 4 pole nickel finish | EP-4-12 |
| | | | 4 pole black finish | EP-4-12B |
| | | | 5 pole nickel finish | EP-5-12 |
| | | | 5 pole black finish | EP-5-12B |
| | | | 6 pole nickel finish | EP-6-12 |
| | | | 6 pole black finish | EP-6-12B |
| | | | 8 pole nickel finish | EP-8-12 |
| 8 pole black finish | EP-8-12B | | | |
|  <p>ISO ASSEMBLY OF EP FEMALE</p> |  | <p>EP Female cable connector, Machined contacts, Metal Shell</p> | 3 pole nickel finish | EP-3-11P |
| | | | 3 pole black finish | EP-3-11PB |
| | | | 4 pole nickel finish | EP-4-11P |
| | | | 4 pole black finish | EP-4-11PB |
| | | | 5 pole nickel finish | EP-5-11P |
| | | | 5 pole black finish | EP-5-11PB |
| | | | 6 pole nickel finish | EP-6-11P |
| | | | 6 pole black finish | EP-6-11PB |
| | | | 8 pole nickel finish | EP-8-11P |
| 8 pole black finish | EP-8-11PB | | | |

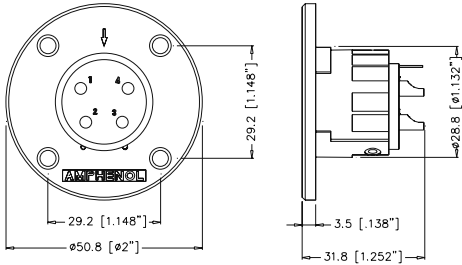

| PRODUCT - FIGURE | DRAWING | DESCRIPTION | VARIATIONS | PART NUMBER |
|---|--|--|----------------------|-------------|
|  | <p style="text-align: center;">Dimensions in mm (inches)</p> | <p>EP Male chassis mount, Round Flange, Machined contacts, Metal Shell</p> | 3 pole nickel finish | EP-3-14 |
| | | | 3 pole black finish | EP-3-14B |
| | | | 4 pole nickel finish | EP-4-14 |
| | | | 4 pole black finish | EP-4-14B |
| | | | 5 pole nickel finish | EP-5-14 |
| | | | 5 pole black finish | EP-5-14B |
| | | | 6 pole nickel finish | EP-6-14 |
| | | | 6 pole black finish | EP-6-14B |
| | | | 8 pole nickel finish | EP-8-14 |
| | | | 8 pole black finish | EP-8-14B |
|  | | <p>EP Female chassis mount, Round Flange, Machined contacts, Metal Shell</p> | 3 pole nickel finish | EP-3-13P |
| | | | 3 pole black finish | EP-3-13PB |
| | | | 4 pole nickel finish | EP-4-13P |
| | | | 4 pole black finish | EP-4-13PB |
| | | | 5 pole nickel finish | EP-5-13P |
| | | | 5 pole black finish | EP-5-13PB |
| | | | 6 pole nickel finish | EP-6-13P |
| | | | 6 pole black finish | EP-6-13PB |
| | | | 8 pole nickel finish | EP-8-13P |
| | | | 8 pole black finish | EP-8-13PB |





The AP Series provides the same power handling performance as the EP Series in a cost effective, yet durable Thermoplastic housing.

Features:

- Solder Bucket connections.
- Precision machined contacts.
- Thermoplastic Housings
- High current contacts
- Male & Female Cable and Chassis connectors available.

Specifications: Page 67

Panel Cutouts: Page 68

| PRODUCT - FIGURE | DRAWING | Dimensions in mm (inches) | DESCRIPTION | VARIATIONS | PART NUMBER |
|------------------|---------|--|--|--------------------------------------|--|
| | | 28.8 [1.135"] 100.0 [3.937"] | AP Male cable connector, Machined contacts, Thermoplastic Black shell. | 4 pole 5 pole 6 pole 8 pole | AP-4-12 AP-5-12 AP-6-12 AP-8-12 |
| | | 28.8 [1.132"] 98.7 [3.886"] | AP Female cable connector, Machined contacts, Thermoplastic Black shell. | 4 pole 5 pole 6 pole 8 pole | AP-4-11 AP-5-11 AP-6-11 AP-8-11 |
| | | 29.2 [1.15"] 432.4 [16.276"] 29.2 [1.15"] 450.8 [17.75"] 31.8 [1.252"] | AP Male chassis mount, Round Flange, Machined contacts, Thermoplastic Black shell. | 4 pole 5 pole 6 pole 8 pole | AP-4-14 AP-5-14 AP-6-14 AP-8-14 |
| | | 29.2 [1.148"] 432.4 [16.276"] 29.2 [1.148"] 450.8 [17.75"] 36.5 [1.438"] | AP Female chassis mount, Round Flange, Machined contacts, Thermoplastic Black shell. | 4 pole 5 pole 6 pole 8 pole | AP-4-13 AP-5-13 AP-6-13 AP-8-13 |
| | | 29.2 [1.148"] 432.4 [16.276"] 29.2 [1.148"] 50.0 [1.969"] 40.0 [1.575"] 31.8 [1.252"] | AP Male chassis mount, Rectangular Flange, Machined contacts, Thermoplastic Black shell. | 4 pole 5 pole 6 pole 8 pole | AP-4-22 AP-5-22 AP-6-22 AP-8-22 |
| | | 29.2 [1.148"] 432.4 [16.276"] 29.2 [1.148"] 50.0 [1.969"] 40.0 [1.575"] 36.5 [1.438"] | AP Female chassis mount, Rectangular Flange, Machined contacts, Thermoplastic Black shell. | 4 pole 5 pole 6 pole 8 pole | AP-4-21 AP-5-21 AP-6-21 AP-8-21 |

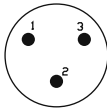
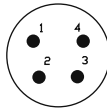
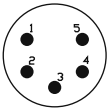
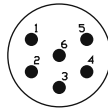
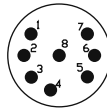

STANDARD DATA EP/AP

| | | VALUE | | | | |
|-----------------------------------|--|---|---|---|---|---|
| GENERAL CHARACTERISTICS | Number of contacts | 3 | 4 | 5 | 6 | 8 |
| | Contact Arrangements (Front view of pin insert) |  |  |  |  |  |
| | Termination | SOLDER | | | | |
| | Wire Gauge - Stranded wire: | 12AWG | 12AWG | 12AWG | 12AWG | 14AWG |
| | Flammability | UL94V-0 | | | | |
| Environmental | Complies with EU RoHS 2 Directive 2011/65/EU | | | | | |
| ELECTRICAL CHARACTERISTICS | Service Voltage RMS ¹⁾ | 460V | 660V | 200V | 200V | 100V |
| | Test Voltage AC RMS | 2400V | 3000V | 1600V | 1600V | 1300V |
| | Current carrying capacity | 20A | 20A | 20A | 20A | 15A |
| | Typical Contact Resistance | ≤3mΩ | | | | |
| | Insulation Resistance | ≥1000MΩ | | | | |
| CLIMATIC CHARACTERISTICS | Protection Class | IP40 | | | | |
| | Operating Temperature | -25 °C to +75 °C (-13°F to +167°F) | | | | |
| MECHANICAL CHARACTERISTICS | Weight - EP 11 & 12 ²⁾ | 80g (0.176lb) | 84g (0.185lb) | 86g (0.189lb) | 86g (0.189lb) | 86g (0.189lb) |
| | Weight - EP 13 & 14 ²⁾ | 48g (0.105lb) | 50g (0.110lb) | 54g (0.119lb) | 54g (0.119lb) | 54g (0.119lb) |
| | Weight - AP 11 & 12 ²⁾ | N/A | 42g (0.092lb) | 44g (0.097lb) | 44g (0.097lb) | 44g (0.097lb) |
| | Weight - AP 13, 14, 21 & 22 ²⁾ | N/A | 26g (0.057lb) | 30g (0.066lb) | 30g (0.066lb) | 28g (0.061lb) |
| | Typical Cable retention force | 22Kg to 44Kg (50lb to 100lb) - Dependant on cable material and diameter | | | | |
| | Mechanical operations | 1000 mating cycles | | | | |

¹⁾ Not suitable for domestic applications above 50V

²⁾ Approximate weight only, does not include packaging. Please contact us for exact weight for shipping purposes.



STANDARD DATA EP/AP (CONT'D)

| | | DETAILS | |
|--------------------------|----------------------------------|----------------------------------|---------------------------------|
| MATERIALS | TYPE | AP | EP |
| | Connector shell | Modified PPE Resin | Diecast Zinc Alloy |
| | Shell finish | Black | Satin Nickel or Black |
| | Insulators | UL94V-0 PBT Resin | |
| | Cable Bushing | Silicon Rubber | UL94 HB Thermoplastic Elastomer |
| | Male contact Machined - Solder | Brass / Bright Tin | |
| | Material / Plating | | |
| | Female contact Machined - Solder | Brass / Bright Tin | |
| | Material / Plating | | |
| CLAMPING CHARACTERISTICS | Cable OD Range | 11mm to 17mm (0.43" to 0.67") | 9mm to 16mm (0.35" to 0.63") |
| | Retention Method | Two opposing plastic screws | Metal saddle clamp |

Rev 3 - 03/2013

EP/AP SERIES PANEL CUTOUT DATA - FRONT VIEW

EP 13/AP 13/AP 21

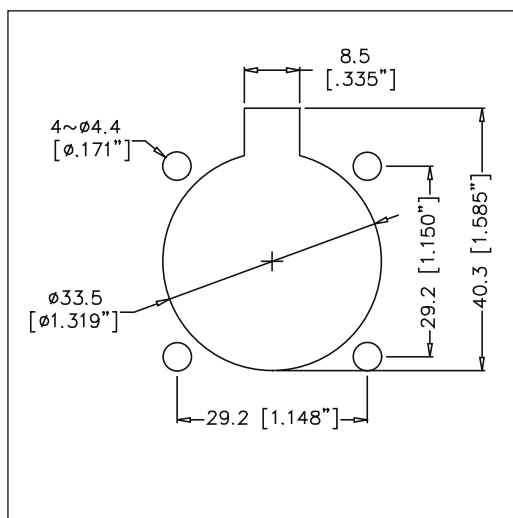

EP 14/AP 14/AP 22

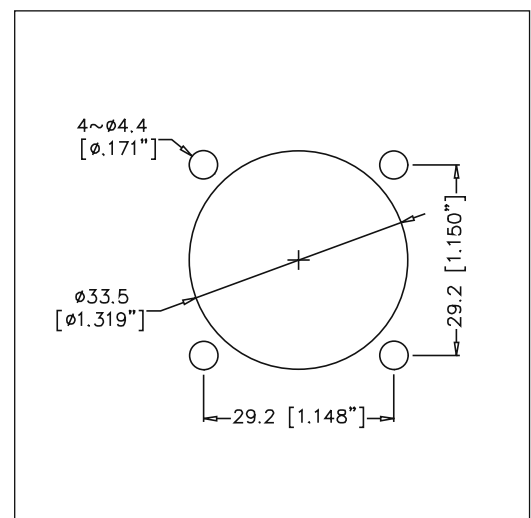



XLrnet CONNECTORS

XLrnet was designed in conjunction with the Amphenol Data / Telecom product group of Amphenol Canada Corp., a subsidiary of Amphenol Corporation. Utilising our combined expertise and knowledge of the professional audio and high-speed data markets we are proud to offer the XLrnet series. Featuring Class D (10/100 BASE-T), CAT5E (1000 BASE-T) or CAT6 (10GBASE-T) ethernet performance in A, B or D shell housings with integrated LED's and complete shielding options we have your high-speed data requirements covered.

Features

- Class D (10/100 BASE-T), CAT5E (1000 BASE-T) or CAT6 (10GBASE-T) ethernet performance
- A, B or D type chassis housings
- IDC or IDC 110 punch down terminals
- RJ45 feedthrough panel connectors
- Shielded or non-shielded
- LED indicators in a variety of colours.
- Compact design
- Cable plug housings
- Quick and simple installation

Options

- Horizontal or Vertical PCB contacts
- Bulk Packaging
- LED colour - Red, Green, Yellow or Blue combinations

Ordering Codes

We have listed the more common ordering codes in each section. Please contact us if you need any further assistance.

Simple steps to guide you in using this catalogue

- 1) Identify the product group listed in Contents on page 1 and go directly to that page number.
- 2) Each product group cover page then details information and options available.
- 3) Refer to the product detail pages and identify the product you require pictorially.
- 4) Read the product description column for the products standard features.
- 5) Use variations column to determine your choice.
- 6) Identify part number.
- 7) In the event the particular option you require is not listed please refer to the part number breakdown page at the end of each section.
- 8) Please contact us directly if you have any further problems.





XLRnet SERIES

Features/Benefits:

- XLR RJ45 Cable plug housing.
- Designed for pre-assembled RJ45 cables.
- Quick and simple installation.
- Cost effective method for harsh environments.
- No cabling in field required.
- No tools required for installation.
- Available in Nickel or Black housings.
- Coloured boots / Backshells

Specifications: Page 71

Part Number Breakdown : Page 71

Assembly Instructions: Page 72

NOTE* RJ45 preassembled cable sold separately and is not included with the XLRnet connector.

| PRODUCT - FIGURE | DRAWING | Dimensions in mm (inches) | DESCRIPTION | VARIATIONS | PART NUMBER |
|------------------|---------|---------------------------|---|------------|-------------|
| | | 84 [3.31\"/> | XLRnet, XLR cable plug housing to suit pre-assembled RJ45 cables, Nickel Finish | Standard | RJX8M |
| | | | | Bulk Pack | RJX8M BULK |
| | | 84 [3.31\"/> | XLRnet, XLR cable plug housing to suit pre-assembled RJ45 cables, Black Finish | Standard | RJX8MB |
| | | | | Bulk Pack | RJX8MB BULK |



ISO VIEW OF RJX8M

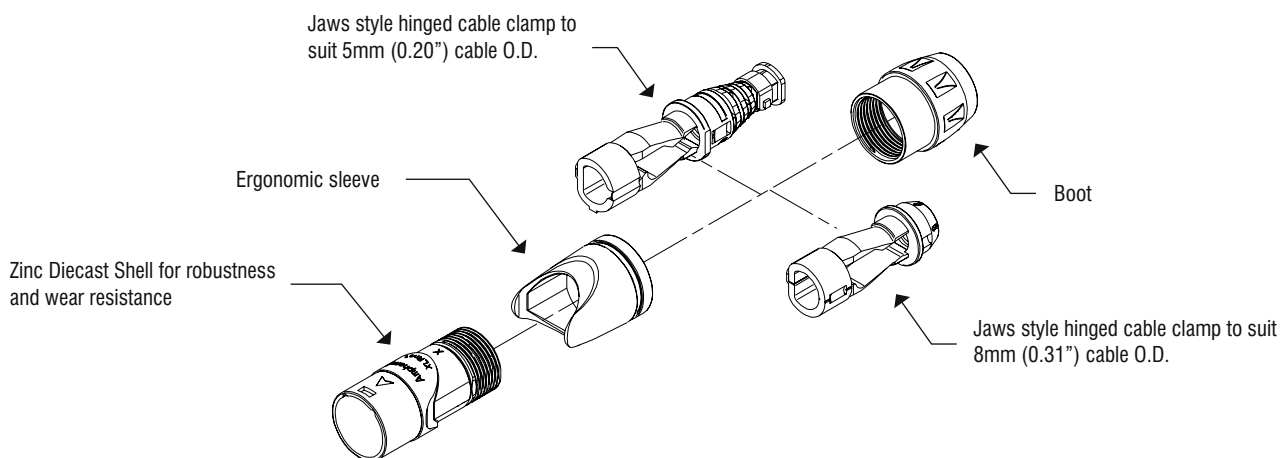

PART NUMBER BREAKDOWN

XLRnet SERIES

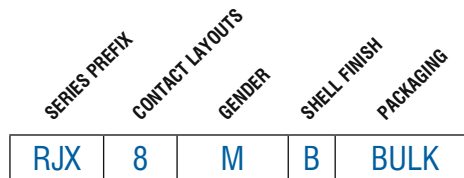

E. G. **RJX8MB BULK**
RJX (Series Prefix), **8** contacts, **M** (Cable Connector), **B** (Black Finish),
Bulk Packaged

| | | | |
|-----------------------|-------|---|----------------------|
| SERIES PREFIX | RJX | = | Series Prefix |
| CONTACT LAYOUT | 8 | = | RJ45 Cable Housing |
| GENDER | M | = | Male Cable Plug |
| SHELL FINISH | Blank | = | Nickel Plated Finish |
| | B | = | Metal - Black Finish |
| PACKAGING | Blank | = | Individual Bags |
| | BULK | = | Bulk Packed |

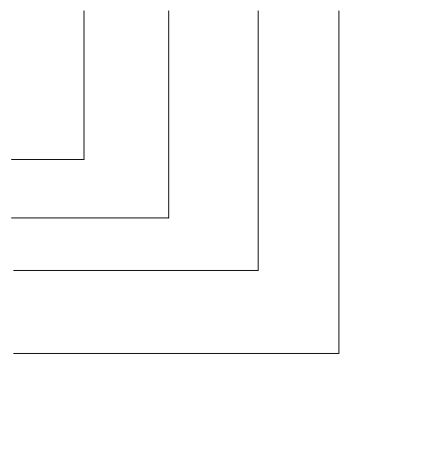

STANDARD DATA XLRnet SERIES



| | | VALUE |
|-----------------------------------|---|--|
| GENERAL CHARACTERISTICS | Termination | Preassembled RJ45 Cable (Not supplied) |
| | Environmental | Complies with EU RoHS 2 Directive 2011/65/EU |
| CLIMATIC CHARACTERISTICS | Protection Class | IP40 |
| | Operating Temperature | -25 °C to +75 °C (-13°F to +167°F) |
| MECHANICAL CHARACTERISTICS | Insertion and Withdrawal force | ≥10N - ≤20N |
| | Weight ²⁾ | 26g (0.057lb) |
| | Cable O.D. range | 5 or 8mm (0.20" or 0.31") |
| | Mechanical Operations | 1000 mating cycles |
| MATERIALS | Connector shell - Metal Shell finish | Diecast Zinc Alloy Satin nickel or Black |
| | Boot / Backshell Finish | UL94V-0 Noryl N190 / Valox Black |
| | Cable clamp | PA6 |
| | Sleeve | Valox |

²⁾ Approximate weight only, does not include packaging. Please contact us for exact weight for shipping purposes.

XLRnet SERIES CABLE ASSEMBLY INSTRUCTIONS

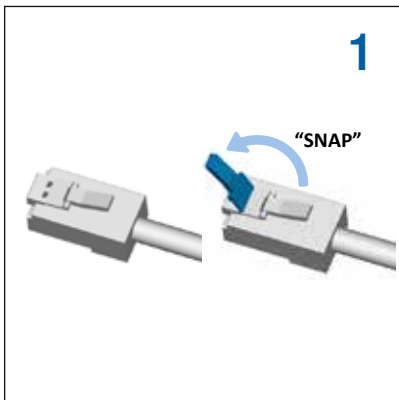

1
Snap or cut off release tab of the RJ45 plug.
⚠ Failure to remove the RJ45's Release Tab will make the XLRnet assembly permanently latching. The XLRnet series has an independent panel side latching system.

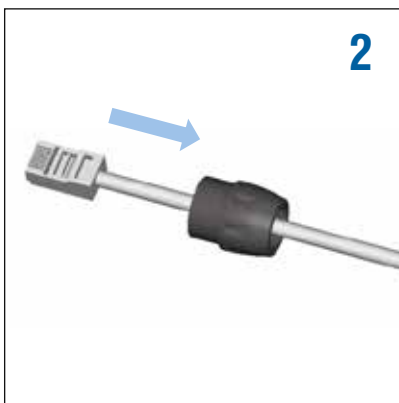

2
Slide the nut (backshell) onto the cable.

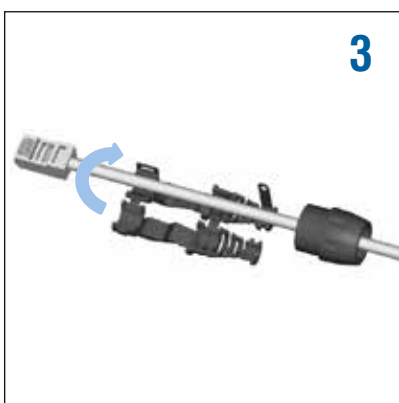

3
Install the cable clamp-boot.



4
Close clamp-boot, fasten the two tabs together to lock.

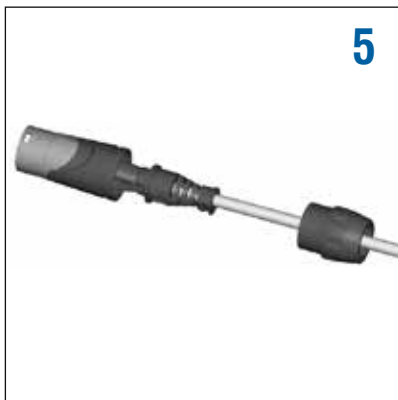

5
Push clamp-boot & cable together into the shell

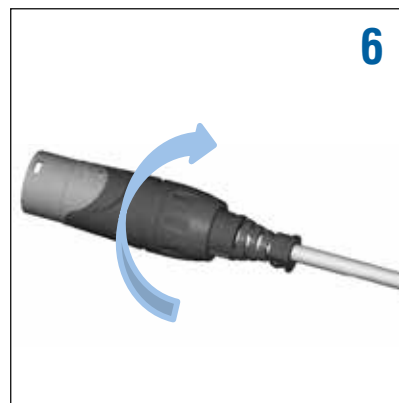

6
Thread the nut (backshell) onto the shell (torque 0.8Nm-1.2Nm) to close the connector assembly.



Amphenol

XLrnet CHASSIS MOUNT CONNECTORS



Features:

- RJ45 Class D (10/100 BASE-T), CAT5E (1000 BASE-T) or CAT6 (10GBASE-T) Ethernet performance
- A or B type chassis housings
- Shielded or non-shielded
- LED indicators in a variety of colours.
- Horizontal or Vertical PCB
- Mates with XLrnet cable plugs or standard RJ45 plug.

Part Number Breakdown: Page 76

Specifications: Page 80

PCB Footprints: PagePage 79







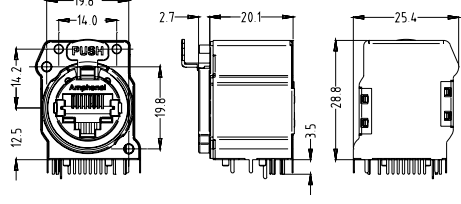

Recommended Fastener: Page 133

| PRODUCT - FIGURE | DRAWING | Dimensions in mm (inches) | DESCRIPTION | TYPE | LED* LHS/RHS | PART NUMBER | |
|------------------|---------|---------------------------|---|---------|-----------------|-------------|-------------|
| | | | XLrnet chassis, A type, Horizontal PCB | Class D | - | RJX8FA3HB | |
| | | | | CAT5E | - | RJX8FA5HB | |
| | | | | CAT6 | - | RJX8FA6HB | |
| | | | XLrnet chassis B type, Horizontal PCB | Class D | - | RJX8FB3HB | |
| | | | | CAT5E | - | RJX8FB5HB | |
| | | | | CAT6 | - | RJX8FB6HB | |
| | | | XLrnet chassis, B type, LEDs, Horizontal PCB, Bulk packed | CAT5E | R | G | RJX8FB5HRGB |
| | | | | | R | Y | RJX8FB5HRYB |
| | | | | | R | R | RJX8FB5HRRB |
| | | | | | G | R | RJX8FB5HGRB |
| | | | | | G | Y | RJX8FB5HGYB |
| | | | | | U | U | RJX8FB5HUUB |
| | | | | CAT6 | R | G | RJX8FB6HRGB |
| | | | | | R | Y | RJX8FB6HRYB |
| | | | | | R | R | RJX8FB6HRRB |
| | | | | | G | R | RJX8FB6HGRB |
| G | Y | RJX8FB6HGYB | | | | | |
| U | U | RJX8FB6HUUB | | | | | |
| | | | XLrnet chassis, B type, Shielded Hood, Horizontal PCB, Bulk packed | Class D | - | RJX8FB3HEB | |
| | | | | CAT5E | - | RJX8FB5HEB | |
| | | | | CAT6 | - | RJX8FB6HEB | |

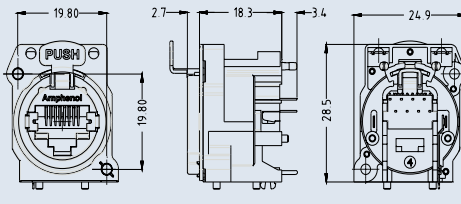
*Note: LED colours are denoted left to right from the panel side front view. Refer page 79
R = Red, G = Green, Y = Yellow, U = Blue

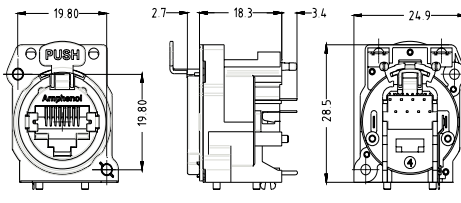

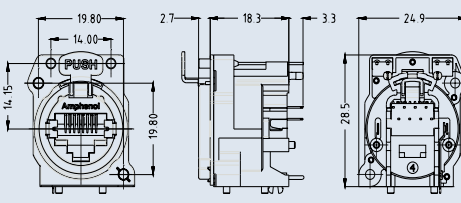
Amphenol

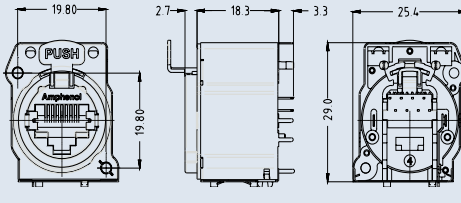
| PRODUCT - FIGURE | DRAWING | Dimensions in mm (inches) | DESCRIPTION | TYPE | LED* LHS/RHS | PART NUMBER |
|---|---|---------------------------|--|---------|-----------------|---------------|
|  |  | | XLRnet chassis, B type, Shielded Hood, LEDs, Horizontal PCB, Bulk packed | CAT5E | R G | RJX8FB5HRGEB |
| | | | | | R Y | RJX8FB5HRYEB |
| | | | | | R R | RJX8FB5HRRREB |
| | | | | | G R | RJX8FB5HGREB |
| | | | | | G Y | RJX8FB5HGYEB |
| | | | | | U U | RJX8FB5HUUEB |
| | | | | CAT6 | R G | RJX8FB6HRGEB |
| | | | | | R Y | RJX8FB6HRYEB |
| | | | | | R R | RJX8FB6HRRREB |
| | | | | | G R | RJX8FB6HGREB |
| | | | | | G Y | RJX8FB6HGYEB |
| | | | | | U U | RJX8FB6HUUEB |
|  |  | | XLRnet chassis, A type, Vertical PCB | Class D | - - | RJX8FA3VB |
| | | | | CAT5E | | RJX8FA5VB |
| | | | | CAT6 | | RJX8FA6VB |
|  |  | | XLRnet chassis, B Type, Vertical PCB | Class D | - - | RJX8FB3VB |
| | | | | CAT5E | | RJX8FB5VB |
| | | | | CAT6 | | RJX8FB6VB |
|  |  | | XLRnet chassis, B type, LEDs, Vertical PCB, Bulk packed | CAT5E | R G | RJX8FB5VRGB |
| | | | | | R Y | RJX8FB5VRYB |
| | | | | | R R | RJX8FB5VRRB |
| | | | | | G R | RJX8FB5VGRB |
| | | | | | G Y | RJX8FB5VGYB |
| | | | | | U U | RJX8FB5VUUB |
| | | | | CAT6 | R G | RJX8FB6VRGB |
| | | | | | R Y | RJX8FB6VRYB |
| | | | | | R R | RJX8FB6VRRB |
| | | | | | G R | RJX8FB6VGRB |
| | | | | | G Y | RJX8FB6VGYB |
| | | | | | U U | RJX8FB6VUUB |
|  |  | | XLRnet chassis, B type, Shielded Hood, Vertical PCB, Bulk packed | Class D | - - | RJX8FB3VEB |
| | | | | CAT5E | | RJX8FB5VEB |
| | | | | CAT6 | | RJX8FB6VEB |

*Note: LED colours are denoted left to right from the panel side front view. Refer page 79
R = Red, G = Green, Y = Yellow, U = Blue

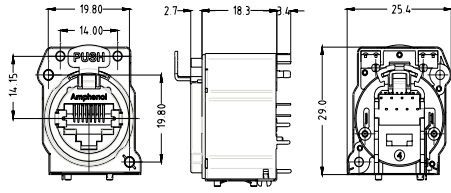
| PRODUCT - FIGURE | DRAWING Dimensions in mm (inches) | DESCRIPTION | TYPE | LED* LHS/RHS | | PART NUMBER |
|---|---|---|-------|-----------------|---|--------------|
|  |  | XLRnet chassis, B type, Shielded Hood, LEDs, Vertical PCB, Bulk packed | CAT5E | R | G | RJX8FB5VRGEB |
| | | | | R | Y | RJX8FB5VRYEB |
| | | | | R | R | RJX8FB5VRREB |
| | | | | G | R | RJX8FB5VGRGB |
| | | | | G | Y | RJX8FB5VGYEB |
| | | | | U | U | RJX8FB5VUUUB |
| | | | CAT6 | R | G | RJX8FB6VRGEB |
| | | | | R | Y | RJX8FB6VRYEB |
| | | | | R | R | RJX8FB6VRREB |
| | | | | G | R | RJX8FB6VGRGB |
| | | | | G | Y | RJX8FB6VGYEB |
| | | | | U | U | RJX8FB6VUUUB |

*Note: LED colours are denoted left to right from the panel side front view. Refer page 79
R = Red, G = Green, Y = Yellow, U = Blue



PART NUMBER BREAKDOWN

XLRnet A AND B TYPE Printed Circuit Board Connectors

E. G. **RJX8FB5HLRREB**
RJX (Series Prefix), **8** (Contacts), **F**emale **B** type, **5** Cat5E **H**orizontal, Latchless,
Red - Red LEDs, **EMI** / RFI Hood, **B**ulk Packaged.

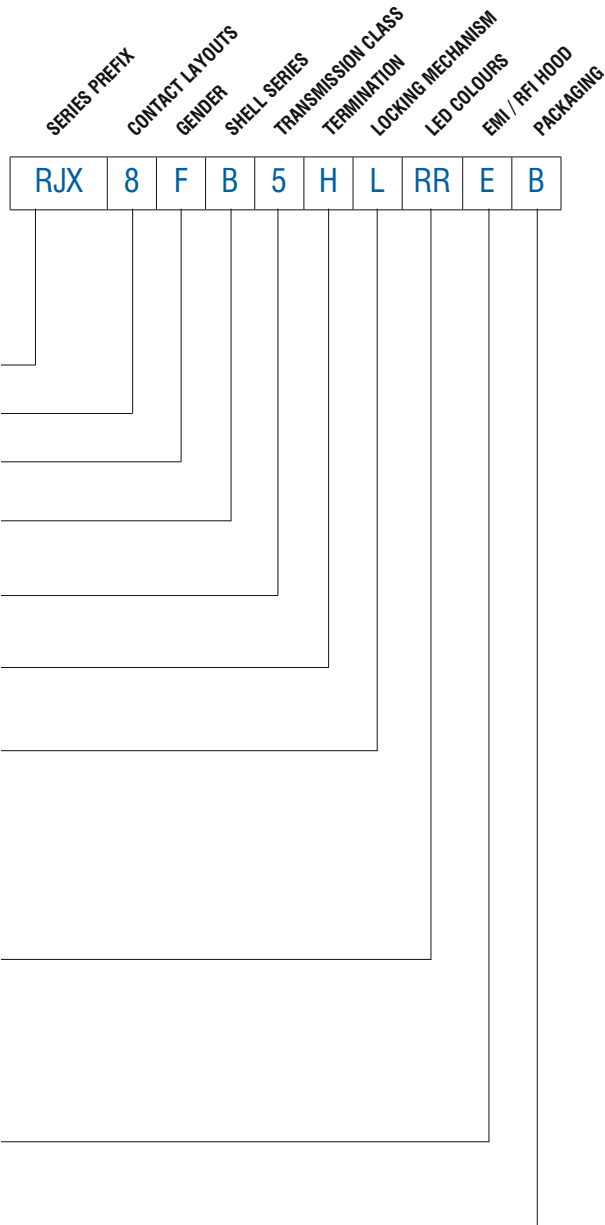

| | | |
|---------------------------------|---|---|
| SERIES PREFIX | RJX = | Series Prefix |
| CONTACT LAYOUT | 8 = | RJ45 type |
| GENDER | F = | Receptacle housing |
| SHELL SERIES | A = B = | A Type B Type |
| TRANSMISSION CLASS | 3 = 5 = 6 = | Class D CAT 5e CAT 6 |
| TERMINATION | H = V = | Horizontal Printed Circuit Board Vertical Printed Circuit Board |
| LOCKING MECHANISM | Blank = P = | Latching Push lever supplied separately for customer installation (Contact factory for detailed fitting instructions) |
| LED COLOUR SEQUENCE* | Blank = RG = RY = RR = GR = GY = GG = YR = YY = YG = UU = | No LEDs Red / Green Red / Yellow Red / Red Green / Red Green / Yellow Green / Green Yellow / Red Yellow / Yellow Yellow / Green Blue / Blue |
| EMI / RFI SHIELDING HOOD | Blank = E = | No shield hood EMI / RFI shield hood |
| PACKAGING | Blank = B = | Individual Bulk packed |

*Note: LED colours are denoted left to right from the panel side front view.
Refer Page 79



Amphenol

XLRnet CHASSIS CONNECTORS

D TYPE FLANGE



Features:

- RJ45 Class D (10/100 Base-T), CAT5E (1000 Base-T) or CAT6 (10GBASE-T) Ethernet performance
- D type XLR standard housings
- IDC Punchdown block
- Thru-adaptor / Feedthrough
- Horizontal or Vertical PCB

Part Number Breakdown: Page 78

Specifications: Page 80

PCB Footprints: Page 79

Recommended Fastener: Page 133

| PRODUCT - FIGURE | DRAWING | Dimensions in mm (inches) | DESCRIPTION | TYPE | PART NUMBER |
|------------------|---------|---------------------------|--|---------|-------------|
| | | | XLRnet chassis, D type, Feedthrough, Nickel Finish | CAT5E | RJX8FD5T |
| | | | | CAT6 | RJX8FD6T |
| | | | XLRnet chassis, D type, IDC Terminals, 110 type, Nickel Finish | CAT5E | RJX8FD5110 |
| | | | | CAT6 | RJX8FD6110 |
| | | | XLRnet chassis, D type, IDC Terminals, Nickel Finish | CAT5E | RJX8FD5I |
| | | | | CAT6 | RJX8FD6I |
| | | | XLRnet chassis, D type, Horizontal PCB, Nickel Finish | Class D | RJX8FD3HB |
| | | | | CAT5E | RJX8FD5HB |
| | | | | CAT6 | RJX8FD6HB |
| | | | XLRnet chassis, D type, Vertical PCB, Nickel Finish | Class D | RJX8FD3VB |
| | | | | CAT5E | RJX8FD5VB |
| | | | | CAT6 | RJX8FD6VB |



PART NUMBER BREAKDOWN

XLRnet D TYPE Chassis Connectors

E. G . **RJX8FD3TB**
RJX (Series Prefix), **8** (Contacts), **F**emale **D** type, **3** Class **D** Thru Adaptor,
Bulk Packaged

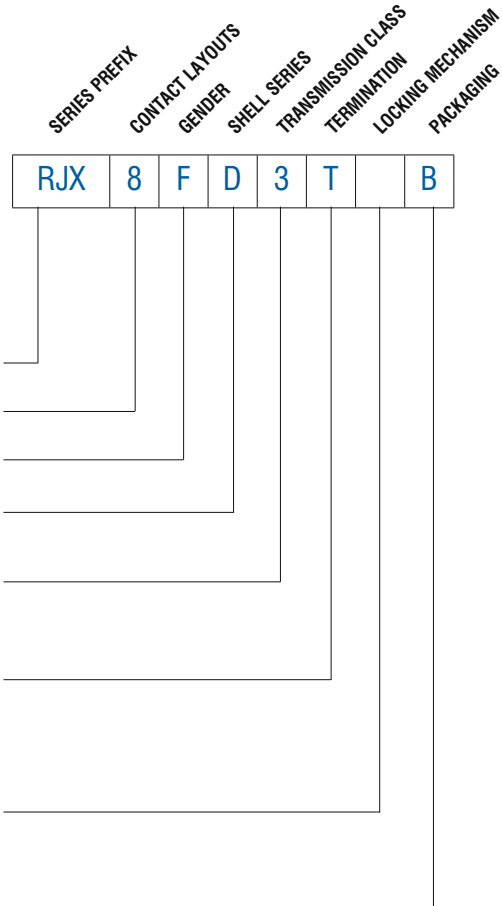

| | | | |
|---------------------------|-------|---|---|
| SERIES PREFIX | RJX | = | Series Prefix |
| CONTACT LAYOUT | 8 | = | RJ45 type |
| GENDER | F | = | Receptacle housing |
| SHELL SERIES | D | = | D Type |
| TRANSMISSION CLASS | 3 | = | Class D |
| | 5 | = | CAT 5e |
| | 6 | = | CAT 6 |
| TERMINATION | H | = | Horizontal Printed Circuit Board |
| | I | = | IDC Punch Down Block |
| | 110 | = | IDC 110 Punch Down Block |
| | T | = | Thru adaptor / Feedthrough |
| LOCKING MECHANISM | Blank | = | Latching |
| | P | = | Push lever supplied separately for customer installation (Contact factory for detailed fitting instructions) |
| PACKAGING | Blank | = | Individual |
| | B | = | Bulk packed |

*Note: LED colours are denoted left to right from the panel side front view.
Refer Page 79



XLrNET A, B AND D TYPE SERIES

* Applicable to 3 (Class D), 5 (CAT5E) and 6 (CAT6), where available

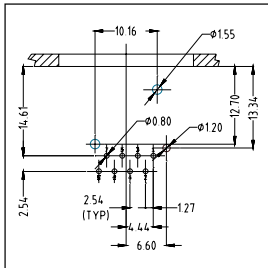

RJX8FA*H
RJX8FA*HB

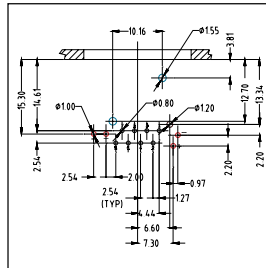

RJX8FB*HRGB
RJX8FB*HRYB
RJX8FB*HRRB
RJX8FB*HGRB
RJX8FB*HGYB
RJX8FB*HGGB

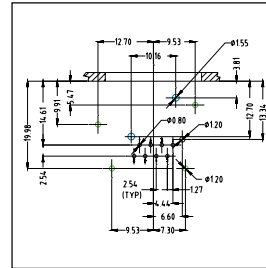

RJX8FB*HEB

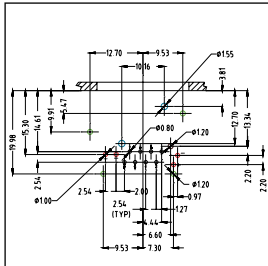

RJX8FB*HRGEB
RJX8FB*HRYEB
RJX8FB*HRRB
RJX8FB*HGREB
RJX8FB*HGYEB
RJX8FB*HGGB

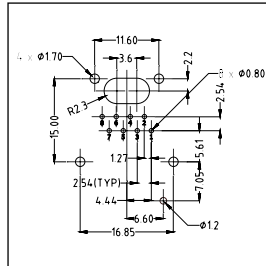

RJX8FA*VB
RJX8FB*VB

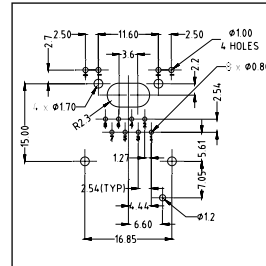

RJX8FB*VRGB
RJX8FB*VRYB
RJX8FB*VRRB
RJX8FB*VGRB
RJX8FB*VGYB
RJX8FB*VUUB

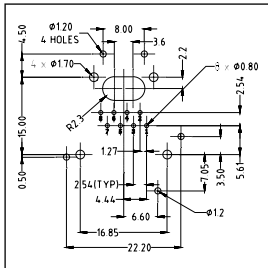

RJX8FB*VEB

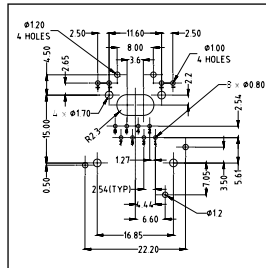

RJX8FB*VRGEB
RJX8FB*VRYEB
RJX8FB*VRRB
RJX8FB*VGREB
RJX8FB*VGYEB
RJX8FB*VUUEB

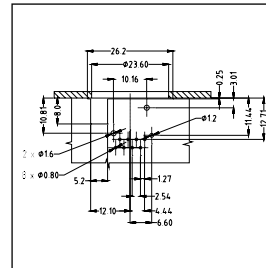

RJX8FD*HB
(Front Mounting)

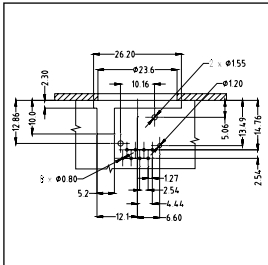

RJX8FD*HB
(Rear Mounting)

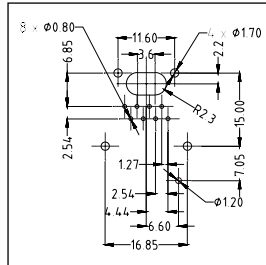

RJX8FD*VB

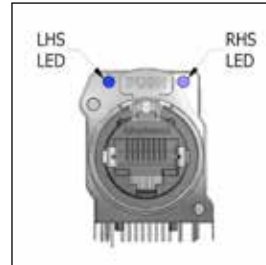

LED Arrangement
(Front view)

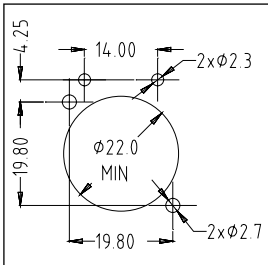

PANEL CUTOUT
A and B type
with LED's

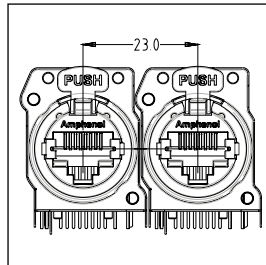

XLrnet
MOUNTING
PITCH /
A and B Type

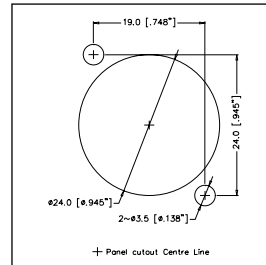

D Type

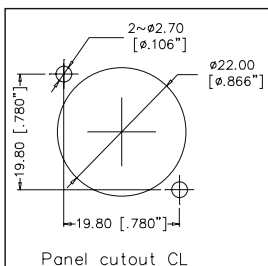

A and B Type



STANDARD DATA XLRnet CHASSIS RECEPTACLES

| | | VALUE | | |
|-----------------------------------|--|---|---|-----------|
| | | Class D | CAT5E | CAT6 |
| GENERAL CHARACTERISTICS | Number of contacts | 8 | | |
| | Contact Arrangement | RJ45 | | |
| | Termination | Printed Circuit Board (PCB) - through hole, Feedthrough, IDC Terminal | | |
| | Flammability | UL94V-0 | | |
| | Environmental | Complies with EU RoHS 2 Directive 2011/65/EU | | |
| | Solderability | MIL-STD 202, Method 208 | | |
| ELECTRICAL CHARACTERISTICS | Rated current per contact | 1.5 A | | |
| | Rated Voltage | 125V AC | | |
| | Typical Contact Resistance | 20mΩ | | |
| | Insulation Resistance | > 500MΩ | | |
| | Dielectric Strength | 1000 VAC, 60 secs | | |
| | Max. Frequency | 100Mhz | 250MHz | 250MHz |
| | Ethernet Standard | 10/100 BASE-T | 1000 BASE-T | 10GBASE-T |
| | Transmission Spec. | EIA/ TIA568-C.2, ISO/IEC 11801, EN50173 | | |
| | PoE+ | 802.3at Type 2 | | |
| | LED Type | Round, single pole, indicator | | |
| CLIMATIC CHARACTERISTICS | Protection Class | IP40 (with EMI/RFI shield) | | |
| | Operating Temperature | -40°C to +80°C (-40°F to +176°F) | | |
| MECHANICAL CHARACTERISTICS | Weight** - A & B Housing - Shielded Housing - D Shell | 11g (0.024lb) 17g (0.037lb) 25g (0.055lb) | | |
| | Mechanical Operations | 1000 | | |
| | Insertion and Withdrawal Force | ≤ 21N | | |
| | Latch | Spring Steel | | |
| | Panel Thickness max. | 3mm | | |
| | Mounting screw torque max. | 0.35Nm | | |
| | Fastener | Self-Tapping screw M2.5 | | |
| | MATERIALS | Connector Shell / Housing | Thermoplastic, DSM Stanyl UL94V-0, 30% GF / PA66 30% GF | |
| | Flange (A type) | Thermoplastic, DSM Stanyl UL94V-0, 30% GF | | |
| | Flange (B type) | Diecast Zinc Alloy 3 | | |
| | Flange Finish (B type) | Satin Nickel | | |
| | Contact | Phosphor Bronze | | |
| | Contact Finish - Ground - RJ45 | 0.38μm Au over 1.27μm Ni 1.27μm Au over 1.27μm Ni | | |
| | Metal Hood Shield EMI/RFI | Brass, nickel plated | | |
| | Latch lock and Spring | Spring steel | | |

Rev 3 - 05/2015

**Approximate weight in grams not including packaging. Please contact us for exact weight for shipping purposes.



BNC 75 RF CONNECTORS

Amphenol offers a complete range of high-performance BNC plugs for use in digital/HD video applications. Amphenol's True 75 Ohm BNC connectors perform well up to and beyond 3GHz and are designed to terminate to a variety of popular coaxial cable types. We can also offer custom connectors to suit non-standard cables on request. Plugs feature a precision machined brass body and coupling nut plated with cost effective nickel plating.

Applications

- Broadcast
- High bandwidth video equipment
- D1/D2 serial digital
- Graphic work stations
- Telephony / Workstations

Options

- Crimp Plugs
- Jack to Jack adapters
- Patch Panels
- 'D' Shell Jacks
- Plug to Plug U-Link connectors
- Crimp Tools

Ordering Codes

We have listed the more common ordering codes in each section. Amphenol offer an extensive range of RF connectors for most applications.

Please visit www.amphenolconnex.com for further information. Please contact us if you need any further assistance.

Simple steps to guide you in using this catalogue



- 1) Identify the product group listed in Contents on page 1 and go directly to that page number.
- 2) Each product group cover page then details information and options available.
- 3) Refer to the product detail pages and identify the product you require pictorially.
- 4) Read the product description column for the products standard features.
- 5) Use variations column to determine your choice.
- 6) Identify part number.
- 7) In the event the particular option you require is not listed please refer to the part number breakdown page at the end of each section.
- 8) Please contact us directly if you have any further problems.







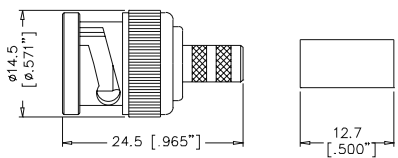
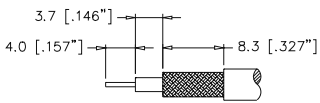

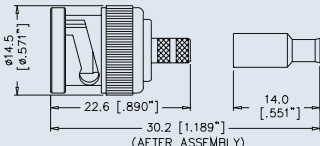
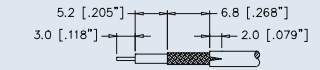



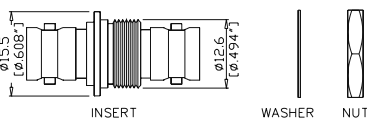

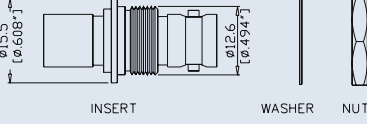

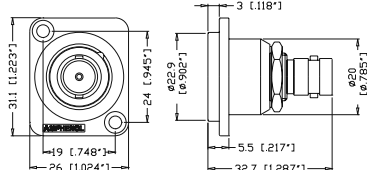

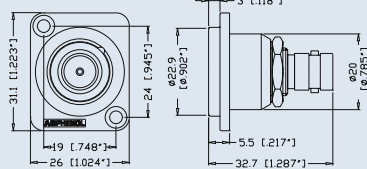
Amphenol manufactures a large range of connectors to suit cables other than those listed below, for example Belden YR23769 and 46899, please contact us to discuss your specific requirements.

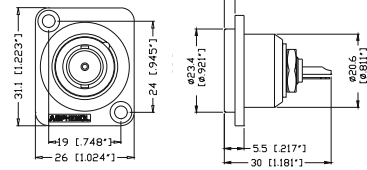
The complete Amphenol Connex catalogue featuring a wide range of RF connector products is available on request. Item code CAT-CONNEX-01.

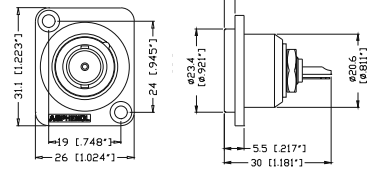
| PRODUCT - FIGURE | DRAWING Dimensions in mm (inches) | CABLE TYPE RG-/U | INSULATION | CRIMP TOOL | PART NUMBER | |
|---|--|------------------|--|------------|-------------|---------|
|    RECOMMENDED CABLE STRIPPING DIMS. | Straight Crimp Plug - Captive Contact- Standard Cable | 59/ 62/ 140/ 210 | Delrin | A | 112119 | |
| | | | Teflon | E | 112952* | |
| | | | 59/ U-20AWG | Delrin | A | 112507 |
| | | | | Teflon | E | 112956* |
| | | | 11/ U-14AWG/ B8213/ B9292/ B7731/ B1859A | Teflon | D | 112606 |
| | | | 6/ 143/ 212 | Delrin | E | 112508 |
| | | | B1694A/ B9248 | Delrin | E | 112565 |
| | | | | Teflon | E | 112957* |
| | | | 6 PLENUM/ B1695A | Delrin | E | 112519 |
| | | | B8281/ B9231/ B9141 | Delrin | E | 112509 |
| | | | | Teflon | E | 112953* |
| | | | B1505A | Teflon | E | 112951* |
| | | B735A1 | Teflon | F | 112950* | |
|   (AFTER ASSEMBLY)  RECOMMENDED CABLE STRIPPING DIMS. | Straight Crimp Plug-Captive Contact-Miniature Cable (Remark: With Teflon sleeve / Hex crimp size .178") | 179/ 187/ B9221 | Delrin | B | 112133 | |
| | | | 180/ 195/ 122/ B8218/ B1865A/ B1855 | Delrin | B | 112521 |
| | | | | Teflon | F | 112955* |

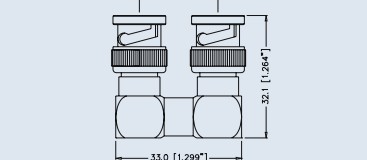
Note: *True 75 ohm.

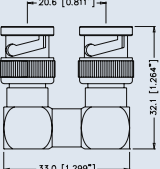
| PRODUCT - FIGURE | DRAWING Dimensions in mm (inches) | DESCRIPTION & CABLE TYPE RG-/U | INSULATION | CRIMP TOOL | PART NUMBER |
|---|--|---|------------|------------|-----------------|
|  |  | Bulkhead Adapter -Isolated Jack to Jack - Straight Bayonet Lock to Bayonet Lock | Teflon | N/A | AC-BNC-JJA-75T* |
|  |  | Bulkhead Adapter -Isolated Jack to Jack - Straight Push on to Bayonet Lock | Teflon | N/A | AC-BNC-PJA-75T* |
|  |  | Bulkhead Adapter -Isolated, 'D' Shell Housing Jack to Jack, Bayonet Lock to Bayonet Lock, Nickel Finish | Teflon | N/A | AC-BNC-JJ-75* |
|  |  | Bulkhead Adapter -Isolated, 'D' Shell Housing Jack to Jack, Push on to Bayonet Lock, Nickel Finish | Teflon | N/A | AC-BNC-PJ-75* |
|  |  | Bulkhead Adapter -Isolated, 'D' Shell Housing Jack to Jack, Push on to Bayonet Lock, Black Finish | Teflon | N/A | AC-BNC-PJ-75B* |
|  |  | Bulkhead Receptacle -Isolated, 'D' Shell Housing Jack to Solder Bucket with Ground Tag, Nickel Finish | Nylon | N/A | AC-BNC-JS-75 |
|  |  | Bulkhead Receptacle -Isolated, 'D' Shell Housing Jack to Solder Bucket with Ground Tag, Black Finish | Nylon | N/A | AC-BNC-JS-75B |
|  |  | U - Link Centre to Centre - 20.6 mm Note: Custom Sizes available please contact factory. | Teflon | N/A | BNC-U-LINK 75*1 |

BNC 75 RF ACCESSORIES AND TOOLING

| PRODUCT - FIGURE | DESCRIPTION | DIE CAVITIES | CABLE TYPE RG-/U | CONNECTOR GUIDE | PART NUMBER |
|---|-------------------------|---------------------------|--------------------------|-----------------|-------------|
|  | Crimp tool with Die Set | .255 / .213 / .068 | 59 / 62 | A | 47-10070 |
| | | .178 / .128 / .068 | 179 / 187 / 180 / 195 | B | 47-10150 |
| | | .429 / .100 / .080 | 11 | D | 47-10090 |
| | | .324 / .255 / .068 / .042 | 6 / 59 / B8281 | E | 47-10110 |
| | | .213 / .178 / .068 / .042 | AT&T 735A, B1855A, B8218 | F | 47-10120 |

Note: *True 75 ohm.





Features:

- Amphenol True 75 Ohm Connectors
- Bayonet lock or Push-on types
- Supplied with adhesive strip ID labels

Options:

- 1RU, 20 BNC connectors or 2RU, 40 BNC connectors
- Aluminium in Clear or Black anodised
- Steel in Black powder coat
- Customised versions available on request

| PRODUCT - FIGURE DRAWING | Dimensions in mm (inches) | DESCRIPTION | MATERIAL / FINISH | LOADED WITH <small>(refer to page 84 for specifications)</small> | PART NUMBER |
|--------------------------|---------------------------|--|-------------------|---|-------------|
| | | 1RU 1X20 Patch Panel, Supplied with 1 ID label | Steel / Black | Empty Panel | AC-BNC20M |
| | | Steel / Black | AC-BNC-JJA-75 | AC-BNC20MJ75 | |
| | | Steel / Black | AC-BNC-PJA-75 | AC-BNC20MP75 | |
| | | Aluminium / Clear | Empty Panel | AC-BNC20A | |
| | | Aluminium / Clear | AC-BNC-JJA-75 | AC-BNC20AJ75 | |
| | | Aluminium / Clear | AC-BNC-PJA-75 | AC-BNC20AP75 | |
| | | Aluminium / Black | Empty Panel | AC-BNC20B | |
| | | Aluminium / Black | AC-BNC-JJA-75 | AC-BNC20BJ75 | |
| | | Aluminium / Black | AC-BNC-PJA-75 | AC-BNC20BP75 | |
| | | 2RU 2X20 Patch Panel, Supplied with 2 ID labels | Steel / Black | Empty Panel | AC-BNC40M |
| | | Steel / Black | AC-BNC-JJA-75 | AC-BNC40MJ75 | |
| | | Steel / Black | AC-BNC-PJA-75 | AC-BNC40MP75 | |
| | | Aluminium / Clear | Empty Panel | AC-BNC40A | |
| | | Aluminium / Clear | AC-BNC-JJA-75 | AC-BNC40AJ75 | |
| | | Aluminium / Clear | AC-BNC-PJA-75 | AC-BNC40AP75 | |
| | | Aluminium / Black | Empty Panel | AC-BNC40B | |
| | | Aluminium / Black | AC-BNC-JJA-75 | AC-BNC40BJ75 | |
| | | Aluminium / Black | AC-BNC-PJA-75 | AC-BNC40BP75 | |
| Panel ID label | Plastic | Not Applicable | AC-BNC-LABEL | | |



BNC 75 RF ASSEMBLY INSTRUCTIONS

ASSEMBLY A

STEP 1

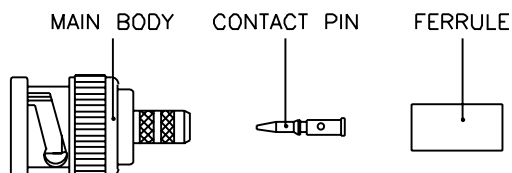

STEP 2

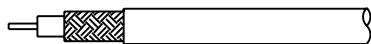

STEP 3

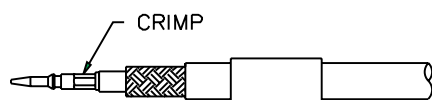

STEP 4

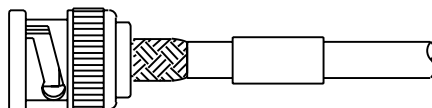

STEP 5

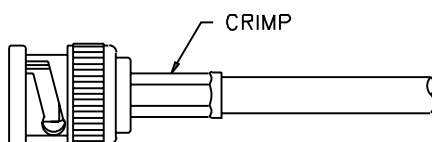

STEP 1. All parts of the connector are shown. A crimp tool is necessary to complete the connection.

STEP 2. Strip the cable inner conductor, dielectric, braid, and jacket as per "RECOMMENDED CABLE STRIPPING DIM'S" in catalogue.

STEP 3. Insert inner conductor into the CONTACT PIN, crimp it with the crimp tool as shown. Then slide the FERRULE onto cable.

STEP 4. Insert the MAIN BODY into braid and dielectric.

STEP 5. Slide the FERRULE over braid, crimp it with the crimp tool as shown.

ASSEMBLY B

STEP 1

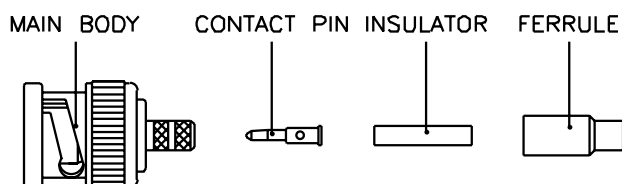

STEP 2

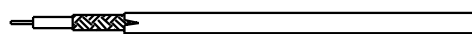

STEP 3

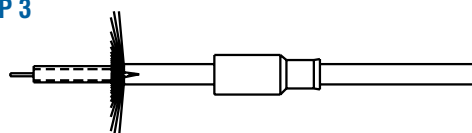

STEP 4

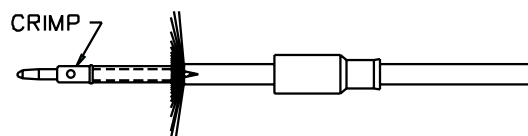

STEP 5

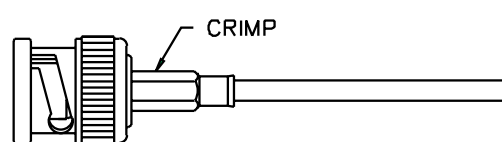

STEP 1. All parts of the connector are shown. A crimp tool is necessary to complete the connection.

STEP 2. Strip the inner conductor, dielectric, and jacket as per "RECOMMENDED CABLE STRIPPING DIM'S" in catalogue.

STEP 3. Slide the FERRULE on to cable, then fold back braid wire and slide the INSULATOR on to dielectric as shown.

STEP 4. Insert inner conductor into the CONTACT PIN, crimp it with crimp tool as shown.

STEP 5. Push cable and parts into the MAIN BODY until it stops. Then slide the FERRULE over braid wire and against the MAIN BODY, crimp it with the crimp tool as shown.



STANDARD DATA BNC 75 RF CONNECTORS

| | | VALUE | |
|-----------------------------------|---------------------------------|--|---------------------------------|
| GENERAL CHARACTERISTICS | Mating | Bayonet Lock | |
| | Cable Attachment | Crimp - Crimp | |
| | Environmental | Complies with EU RoHS 2 Directive 2011/65/EU | |
| ELECTRICAL CHARACTERISTICS | Impedance | 75Ω | |
| | Frequency Range - Standard | 0 - 1 GHz | |
| | - True 75 Ohm | 0 - 4 GHz | |
| | Voltage Rating | 500V RMS | |
| | Dielectric withstanding voltage | 1500 Volts RMS | |
| | VSWR - Standard | 1.05+0.1f(GHz) DC to 1 GHz | |
| | - True 75 Ohm | 1.5+0.1f(GHz) DC to 4 GHz | |
| | Contact Resistance | | |
| Centre Contact | 1.5 milliohm | | |
| Outer Contact | 1.0 milliohm | | |
| Insulation Resistance | 5000 MΩ (min.) | | |
| MATERIALS | Part | Material | Finish |
| | Body, Coupling sleeves | Brass | Nickel |
| | Crimp Ferrule | Annealed Copper | Nickel |
| | Male Contact | Brass | Gold |
| | Female Contact | Beryllium Copper or Phosphor Bronze | Gold |
| | XLR Housing | Diecast Zinc Alloy | Satin Nickel or Black Polyester |
| | Insulators | Teflon or Delrin | Natural |

NOTE: These characteristics are typical and may not apply to all connectors.

PANEL CUTOUTS - FRONT VIEW

AC-BNC-PJ-75
AC-BNC-JJ-75

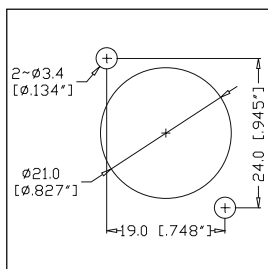

AC-BNC-PJA-75
AC-BNC-JJA-75

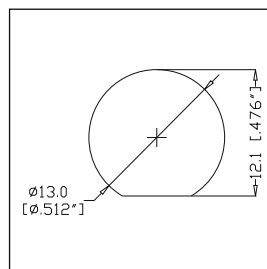

Rev 4 - 03/2013



1/4" PHONE CONNECTORS

Amphenol offers two ranges of 1/4" Phone plug connectors to satisfy the needs of the manufacturer and the end user. The PRO – a heavy duty on-road plug and the MUSICIAN - a solid performing general use plug. Both series offer different features and benefits and the most suitable type will be determined by application, budget and personal choice.

Applications

- Audio Cables and Snakes
- Amplifiers
- Speakers
- Mixing desks
- Rack mount equipment
- Patch panel

Features / Options – PRO RANGE 1/4" Phone Plug T-Series.

- Mono or Stereo (TRS)
- Switching Plugs
- Stylised shell design with Ergonomic grip
- Nickel or Gold contact plating
- Straight or Right Angle
- Keyed Shell
- Optional heavy duty metal backshell / boot
- Great solderability
- Increased solder area on ground contact
- "Jaws" Cable Clamp
- Precision machined contacts
- Coloured Grommet
- JUMBO Series Plugs

Features / Options – MUSICIAN RANGE 1/4" Phone Plug

- Mono or Stereo (TRS)
- Compact Shell
- Straight or Right angle
- Stylish shell design
- Flexible grommet cable protection
- Nickel or Gold contact plating
- Satin Nickel or Black finish
- Diecast shell
- Coloured Grommet

Jaws Cable Clamp Options for T-Series*



Standard Jaws cable clamp (Black), Cable O.D 3mm to 6mm (0.118" to 0.236")



Large Jaws cable clamp (Purple), Cable O.D 6mm to 7mm (0.236" to 0.275")

*Note: Applicable to T-Series straight cable connectors only. Refer to page 95 for right angle connector Jaws cable clamp specifications.

Musician Range Cable Clamp Options



M-Series, Cable O.D 3mm to 6.5mm (0.118" to 0.256")



M-Series II, Cable O.D 6.5mm to 8mm (0.256" to 0.315")

Ordering Codes

We have listed the more common ordering codes in each section. Refer to our 1/4" plug product feature matrix found on the next page for assistance on selecting the right plug for your application.

Simple steps to guide you in using this catalogue

- 1) Identify the product group listed in Contents on page 1 and go directly to that page number.
- 2) Each product group cover page then details information and options available.
- 3) Refer to the product detail pages and identify the product you require pictorially.
- 4) Read the product description column for the products standard features.
- 5) Use variations column to determine your choice.
- 6) Identify part number.
- 7) In the event the particular option you require is not listed please refer to the part number breakdown page at the end of each section.
- 8) Please contact us directly if you have any further problems.



1/4" PLUG FEATURE MATRIX

| FEATURES | | T SERIES (STRAIGHT) | T SERIES (RIGHT ANGLE) | JUMBO T SERIES | SWITCHPLUG T SERIES (STRAIGHT) | SWITCHPLUG T SERIES (RIGHT ANGLE) | M SERIES | M SERIES II | CUSTOM SERIES ¹ |
|---|-----------------------------------|---------------------|------------------------|----------------|--------------------------------|-----------------------------------|----------|-------------|----------------------------|
| PRECISION MACHINED CONTACTS | | X | X | X | X | X | X | X | X |
| CENTER CONTACT | 1 pc. Center Contact | X | X | X | X | X | | | X* |
| | 2 pc Press Fit Tip/Center Contact | | | | | | X | X | X* |
| BARREL: | Machined Tube | X | X | X | X | X | | | |
| | Precision Extruded Tube | | | | | | X | X | X |
| JAWS CABLE CLAMP | | X | X | | X | X | | | |
| MIN. CABLE OD | Black Jaw: 3mm/0.118" | X | X | | X | X | | | |
| | Purple Jaw: 6mm/0.236" | X | | | X | | | | |
| | Purple Jaw: 5.5mm/0.216" | | X | | | X | | | |
| MAX. CABLE OD | Black Jaw: 6mm/0.236" | X | | | X | | | | |
| | Black Jaw: 5.5mm/0.216" | | X | | | X | | | |
| | Purple Jaw: 7.5mm/0.295" | X | | | X | | | | |
| | Purple Jaw: 6.5mm/0.255" | | X | | | X | | | |
| STANDARD CABLE CLAMP | | | | X | | | X | X | X |
| MIN. CABLE OD | 7.5mm/0.295" | | | X | | | | | |
| MAX. CABLE OD | 6mm/0.236" | | | | | | X | | |
| | 8mm/0.315" | | | | | | | X | |
| | 8.8mm/0.345" | | | | | | | | X |
| | 10.5mm/0.413" | | | X | | | | | |
| BACKSHELL FINISH | Satin Nickel | X | X | X | X | X | X | X | |
| | Black | X | X | X | X | X | X | X | |
| | Bright Nickel | | | | | | | | X |
| | Bright Gold | | | | | | | | X |
| CONTACT MATERIAL/ FINISH OPTIONS | Brass/Nickel (Ni) | X | X | X | X | X | X | X | X |
| | Brass/Gold over 2µm (Ni) | X | X | X | X | X | X | X | X |

¹Custom Series - Minimum order quantities apply. Contact us for further details.







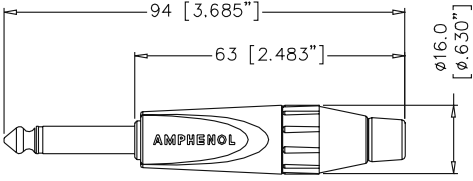

Features:

- Mono or Stereo (TRS).
- Stylised shell design with Ergonomic grip.
- Straight or Right Angle.
- Robust diecast shell in Satin nickel or Black finish.
- Nickel or Gold contact plating.
- Keyed shell.
- Optional heavy duty metal backshell / boot.
- Great solderability.
- Increased solder area on ground contact.
- "Jaws" Cable Clamp.
- Precision machined contacts.
- Quick and easy assembly.

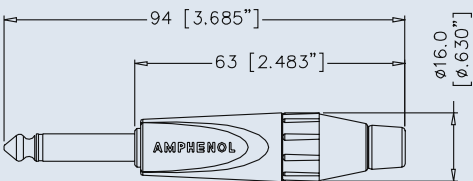
Options: Gold Contacts, Large or Small Jaws Cable Clamp, Black Shell, Metal Backshell / Boot, Bulk Pack. Coloured grommets (ordered separately)

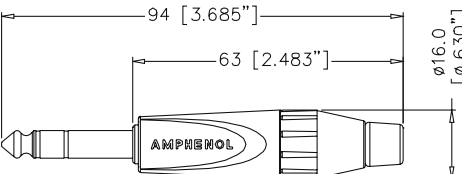
Part Number Breakdown: Page 97 Specifications: Page 98

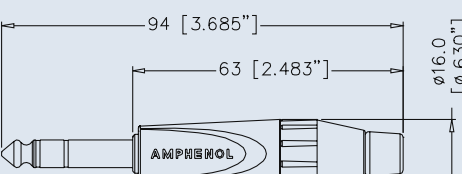
| PRODUCT - FIGURE | DRAWING | DESCRIPTION | VARIATIONS | PART NUMBER |
|---|---|---|--|---|
|  |  | 1/4" (6.35mmø) Mono Phone plug, Jaws cable clamp, Thermoplastic back- shell, Satin finish. | Standard Gold Plated Contacts Large Cable Clamp Bulk Pack | TM2P TM2P-AU TM2PJ TM2P BULK |
|  |  | 1/4" (6.35mmø) Mono Phone plug, Jaws cable clamp, Thermoplastic back- shell, Black finish. | Standard Gold Plated Contacts Large Cable Clamp Bulk Pack | TM2PB TM2PB-AU TM2PBJ TM2PB BULK |
|  |  | 1/4" (6.35mmø) Stereo Phone plug, Jaws cable clamp, Thermoplastic back- shell, Satin finish. | Standard Gold Plated Contacts Large Cable Clamp Bulk Pack | TS3P TS3P-AU TS3PJ TS3P BULK |
|  |  | 1/4" (6.35mmø) Stereo Phone plug, Jaws cable clamp, Thermoplastic back- shell, Black finish. | Standard Gold Plated Contacts Large Cable Clamp Bulk Pack | TS3PB TS3PB-AU TS3PBJ TS3PB BULK |



Amphenol



1/4" PHONE PLUGS

T-SERIES (PRO RANGE)

| PRODUCT - FIGURE | DRAWING | DESCRIPTION | VARIATIONS | PART NUMBER |
|------------------|---------|--|--|---|
| | | 1/4" (6.35mmø) Mono Phone plug, Jaws cable clamp, Metal backshell, Satin finish. | Standard Gold Plated Contacts Large Cable Clamp Bulk Pack | TM2PN TM2PN-AU TM2PNJ TM2PN BULK |
| | | 1/4" (6.35mmø) Mono Phone plug, Jaws cable clamp, Metal backshell, Black finish. | Standard Gold Plated Contacts Large Cable Clamp Bulk Pack | TM2PBM TM2PBM-AU TM2PBMJ TM2PBM BULK |
| | | 1/4" (6.35mmø) Stereo Phone plug, Jaws cable clamp, Metal backshell, Satin finish. | Standard Gold Plated Contacts Large Cable Clamp Bulk Pack | TS3PN TS3PN-AU TS3PNJ TS3PN BULK |
| | | 1/4" (6.35mmø) Stereo Phone plug, Jaws cable clamp, Metal backshell, Black finish. | Standard Gold Plated Contacts Large Cable Clamp Bulk Pack | TS3PBM TS3PBM-AU TS3PBMJ TS3PBM BULK |
| | | 1/4" (6.35mmø) Mono Phone plug, Right angle, Jaws cable clamp*, Thermoplastic backshell, Satin finish. | Standard Gold Plated Contacts Small Cable Clamp Bulk Pack | TM2RJ TM2RJ-AU TM2R TM2RJ BULK |
| | | 1/4" (6.35mmø) Mono Phone plug, Right angle, Jaws cable clamp*, Thermoplastic backshell, Black finish. | Standard Gold Plated Contacts Small Cable Clamp Bulk Pack | TM2RBJ TM2RBJ-AU TM2RB TM2RBJ BULK |
| | | 1/4" (6.35mmø) Stereo Phone plug, Right angle, Jaws cable clamp*, Thermoplastic backshell, Satin finish. | Standard Gold Plated Contacts Small Cable Clamp Bulk Pack | TS3RJ TS3RJ-AU TS3R TS3RJ BULK |
| | | 1/4" (6.35mmø) Stereo Phone plug, Right angle, Jaws cable clamp*, Thermoplastic backshell, Black finish. | Standard Gold Plated Contacts Small Cable Clamp Bulk Pack | TS3RBJ TS3RBJ-AU TS3RB TS3RBJ BULK |

*NOTE: Refer to page 95 for Jaws cable clamp specifications applicable to right angle connectors.



The Amphenol T series SwitchPlug uses a unique 360 degree precision sliding helical spring contact design to quietly and accurately switch the signal circuit safely to ground during instrument changes under load, thereby avoiding annoying thumps, pops and squeals. The sliding ring contact self-cleans every time the plug is connected preventing excessive build up of oxidization and contamination. Activation is directly off the jacks full front face assuring a positive reference point every time, and as it works instantaneously on the main circuits there is no need for the use of magnets or other elaborate switching mechanisms.

WARNING!
For use with
instrument (guitar)
applications only.

Part Number Breakdown: Page 94
Specifications: Page 95

US Patent No.8,162,697

| PRODUCT - FIGURE | DRAWING | Dimensions in mm (inches) | DESCRIPTION | VARIATIONS | PART NUMBER |
|------------------|---------|---------------------------|---|--|---|
| | | | 1/4" (6.35mm \varnothing) Switch Phone plug, Jaws cable clamp, Thermoplastic backshell, Satin finish | Standard Gold Plated Contacts Large Cable Clamp Bulk Pack | TM1P TM1P-AU TM1PJ TM1P BULK |
| | | | 1/4" (6.35mm \varnothing) Switch Phone plug, Jaws cable clamp, Thermoplastic backshell, Black finish | Standard Gold Plated Contacts Large Cable Clamp Bulk Pack | TM1PB TM1PB-AU TM1PBJ TM1PB BULK |
| | | | 1/4" (6.35mm \varnothing) Switch Phone plug, Right angle, Jaws cable clamp*, Thermoplastic backshell, Satin Finish | Standard Gold Plated Contacts Bulk Pack | TM1RJ* TM1RJ-AU* TM1RJ BULK* |
| | | | 1/4" (6.35mm \varnothing) Switch Phone plug, Right angle, Jaws cable clamp*, Thermoplastic backshell, Black Finish | Standard Gold Plated Contacts Bulk Pack | TM1RBJ* TM1RBJ-AU* TM1RBJ BULK* |

*NOTE: Refer to page 98 for Jaws cable clamp specifications applicable to right angle connectors.

Amphenol

SwitchPlug - User Instruction

CAUTION!  Use with instrument (guitar) cables only. DO NOT connect to amplifier output. Equipment damage may result from incorrect use.

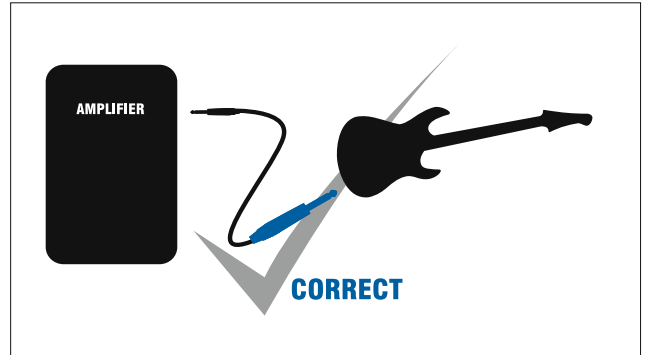
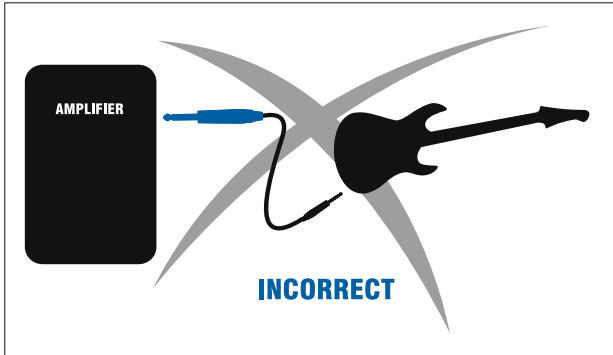

SwitchPlug - Technology*

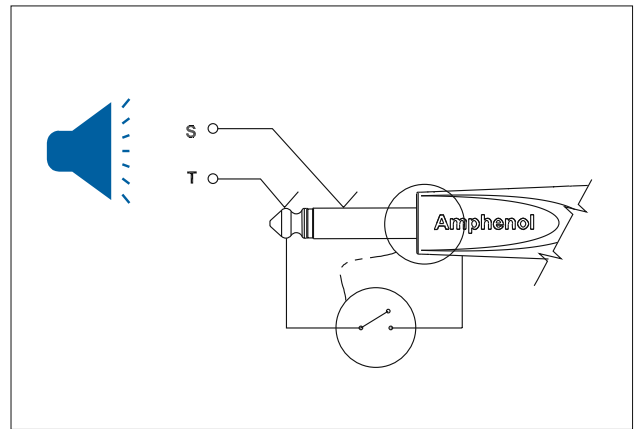
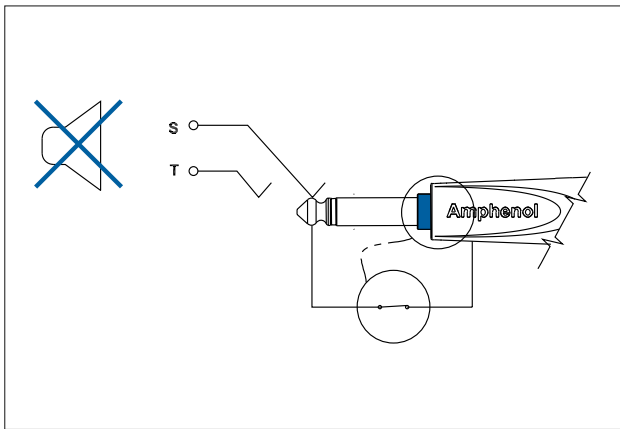

*US Patent No. 8,162,697



Features:

- JUMBO Cable clamping capacity
- Suits Cable OD 7.5mm (0.295") to 10.5mm (0.413")
- Mono or Stereo (TRS).
- Stylised shell design with Ergonomic grip.
- Robust diecast shell in Satin nickel or Black finish.
- Nickel or Gold contact plating.
- Keyed shell.
- Great solderability.
- Increased solder area on ground contact.
- Precision machined contacts.
- Quick and easy assembly.

Options: Gold Contacts, Bulk Pack.

Specifications: Page 95

| PRODUCT - FIGURE | DRAWING | DESCRIPTION | VARIATIONS | PART NUMBER |
|------------------|---------|---|---|---------------------------------|
| | | 1/4" (6.35mm \varnothing) JUMBO Mono Phone plug, Thermoplastic back- shell, Satin finish. | Standard Gold Plated Contacts Bulk Pack | JM2P JM2P-AU JM2P BULK |
| | | 1/4" (6.35mm \varnothing) JUMBO Mono Phone plug, Thermoplastic back- shell, Black finish. | Standard Gold Plated Contacts Bulk Pack | JM2PB JM2PB-AU JM2PB BULK |
| | | 1/4" (6.35mm \varnothing) JUMBO Stereo Phone plug, Thermoplastic back- shell, Satin finish. | Standard Gold Plated Contacts Bulk Pack | JS3P JS3P-AU JS3P BULK |
| | | 1/4" (6.35mm \varnothing) JUMBO Stereo Phone plug, Thermoplastic back- shell, Black finish. | Standard Gold Plated Contacts Bulk Pack | JS3PB JS3PB-AU JS3P BULK |

NOTE: Contact factory for availability of metal backshells.



Amphenol

PART NUMBER BREAKDOWN

T-SERIES (PRO RANGE)

E. G. **TS3PBMJ-AU BULK**
T (Series Prefix), **S3** (Stereo), **PB** (Plug Black), **M** (Metal Nut (Black)), **J** (Large Jaws),
- AU (Gold Plated Contacts), **BULK** Packaged.

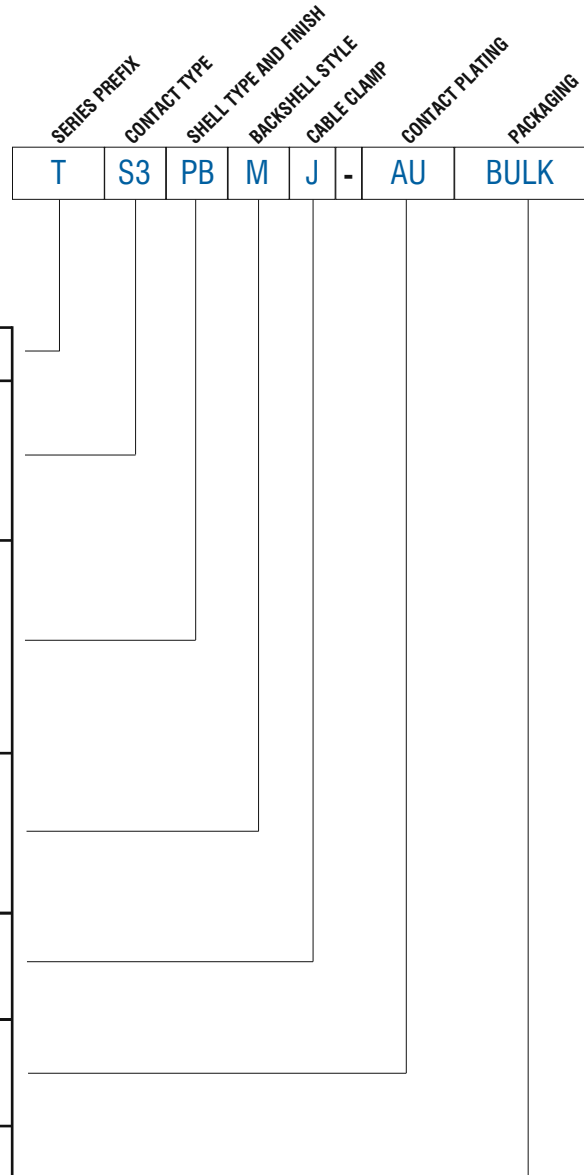

| | | | |
|------------------------------|-------|---|-----------------------------------|
| SERIES PREFIX | T | = | Series Prefix |
| CONTACT TYPE | M1 | = | Switch Plug |
| | M2 | = | 2 Pole (mono) |
| | S3 | = | 3 Pole, tip/ring/sleeve (stereo) |
| SHELL TYPE AND FINISH | P | = | Plug Satin Nickel |
| | PB | = | Plug Matt Black |
| | R | = | Right Angle Plug Satin Nickel |
| | RB | = | Right Angle Plug Matt Black |
| BACKSHELL TYPE | Blank | = | Plastic Nut |
| | M | = | Metal Nut - Black |
| | N | = | Metal Nut - Satin Nickel |
| CABLE CLAMP | Blank | = | Small Jaws |
| | J | = | Large Jaws |
| CONTACT PLATING | Blank | = | Nickel Plated Contacts (Standard) |
| | AU | = | Gold Plated Contacts |
| PACKAGING | Blank | = | Individual Bags |
| | BULK | = | Bulk Packed |

ISO VIEW OF TM2P

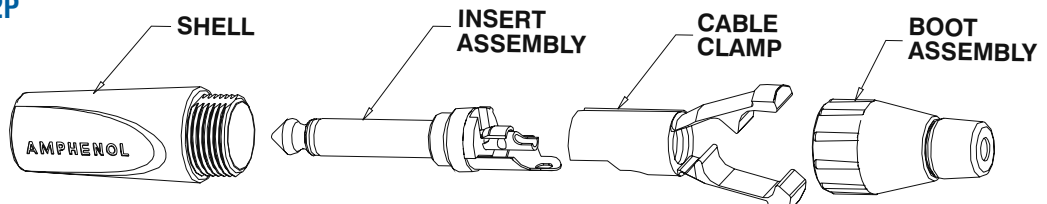

1/4" PHONE PLUG TECHNICAL DATA

| | | VALUE | | |
|-----------------------------------|--|--|--------------------------------------|---------------------------------------|
| | | Straight | Right Angle | Jumbo |
| GENERAL CHARACTERISTICS | Number of Contacts | 3 Pole Tip Ring Sleeve (Stereo) | | |
| | Termination | Solder | | |
| | Max. Wire Gauge - Stranded Wire | 2 Pole (Mono): AWG 16 - 1.5mm ² 3 Pole (Stereo): AWG 18 - 1mm ² | | |
| | Flammability rating of insulating plastics | UL94V-0 | | |
| | Solderability, complies with | IEC 68-2-20 | | |
| | Environmental | Complies with EU RoHS 2 Directive 2011/65/EU | | |
| ELECTRICAL CHARACTERISTICS | Current Carrying Capacity | 10A (Depends on Mating Connector and Cable) | | |
| | Typical Contact Resistance | Depends on Mating Connector | | |
| | Insulation resistance (initial) | >2GΩ | | |
| | After Damp Heat Test | ≥1GΩ | | |
| | Dielectric Withstand Voltage | 2 Pole : 1.5 kV dc 3 Pole : 1 kV dc | | |
| CLIMATIC CHARACTERISTICS | Protection Class | IP40 | | |
| | Operating Temperature | -25°C to +75°C (-13°F to + 167°F) | | |
| MECHANICAL CHARACTERISTICS | Insertion and Withdrawal Force | ≥10N - ≤30N | | |
| | Weight ¹⁾ - Thermoplastic Backshell | 28g (0.061lb) | | |
| | Weight ¹⁾ - Metal Backshell | 35g (0.077lb) | | |
| | Typical Cable Retention Force | 22kg to 44kg (50lb to 100lb) - Dependent on cable material and diameter. | | |
| | Cable O.D. - Standard Jaw | 3mm to 6mm (0.118" to 0.236") | 3mm to 5.5mm (0.118" to 0.216") | NA |
| | Cable O.D. - Large Jaw | 6mm to 7mm (0.236" to 0.275") | 5.5mm to 6.5mm (0.216" to 0.255") | NA |
| | Cable O.D. - Jumbo | NA | NA | 7.5mm to 10.5mm (0.295" to 0.413") |
| | Mechanical Operations | 1000 | | |
| MATERIALS | Connector Shell Material | Diecast Zinc Alloy EZDA No.3 | | |
| | Shell Finish | Satin Nickel or Black Polyester | | |
| | Insulators | UL94 V-0 PBT Resin or Modified PPE Resin - Black | | |
| | Boot / Backshell | UL94 V-0 PBT Resin or Modified PPE Resin - Black or Metal CuZn ³⁹ Pb ³ | | |
| | Cable Clamp | UL94 V-0 PBT Modified PPO Resin - Black | | |
| | Cable Bushing | Santoprene | | |
| | Contacts / Plating | Brass/Ni or Au over 2μm Ni | | |

Rev 5 - 03/2013

¹⁾ Approximate weight only, does not include packaging. Please contact us for exact weight for shipping purposes.





Features:

- Mono or Stereo (TRS).
- AX Series inspired shell design.
- Large cable O.D. Entry to 8mm (0.315")
- Robust diecast shell in Satin nickel or Black finish.
- Nickel or Gold contact plating.
- Flexible grommet cable protection.
- Improved solderability.
- Precision machined contacts.
- Standard or Bulk packaging.

Clamp Info:







Cable O.D 6.5mm to 8mm (0.256" to 0.315")

Options: Black Shell, Gold contacts. Coloured grommets (ordered separately)

Specifications: Page 112

| PRODUCT - FIGURE | DRAWING | DESCRIPTION | VARIATIONS | PART NUMBER |
|------------------|---------|--|----------------------|--------------|
| | | 1/4" (6.35mmø) Mono Phone plug, Diecast Shell, Satin finish, Flexible grommet. | Standard | ACPM-KN |
| | | | Gold Plated Contacts | ACPM-KN-AU |
| | | | Bulk Pack | ACPM-KN-BULK |
| | | 1/4" (6.35mmø) Mono Phone plug, Diecast Shell, Black finish, Flexible grommet. | Standard | ACPM-KB |
| | | | Gold Plated Contacts | ACPM-KB-AU |
| | | | Bulk Pack | ACPM-KB BULK |
| | | 1/4" (6.35mmø) Stereo Phone plug, Diecast Shell, Satin finish, Flexible grommet. | Standard | ACPS-KN |
| | | | Gold Plated Contacts | ACPS-KN-AU |
| | | | Bulk Pack | ACPS-KN BULK |
| | | 1/4" (6.35mmø) Stereo Phone plug, Diecast Shell, Black finish, Flexible grommet. | Standard | ACPS-KB |
| | | | Gold Plated Contacts | ACPS-KB-AU |
| | | | Bulk Pack | ACPS-KB BULK |



| PRODUCT - FIGURE | DRAWING | Dimensions in mm (inches) | DESCRIPTION | VARIATIONS | PART NUMBER |
|---|---------|---------------------------|--|---------------|--------------|
|  | | | <p>1/4" (6.35mmø) Mono Phone plug, Right angle, Diecast Shell, Satin finish, Flexible grommet.</p> | Standard | ACPM-TN |
| | | | | Gold Contacts | ACPM-TN-AU |
| | | | | Bulk Pack | ACPM-TN BULK |
|  | | | <p>1/4" (6.35mmø) Mono Phone plug, Right angle, Diecast Shell, Black finish, Flexible grommet.</p> | Standard | ACPM-TB |
| | | | | Gold Contacts | ACPM-TB-AU |
| | | | | Bulk Pack | ACPM-TB BULK |
|  | | | <p>1/4" (6.35mmø) Stereo Phone plug, Right angle, Diecast Shell, Satin finish, Flexible grommet.</p> | Standard | ACPS-TN |
| | | | | Gold Contacts | ACPS-TN-AU |
| | | | | Bulk Pack | ACPS-TN BULK |
|  | | | <p>1/4" (6.35mmø) Stereo Phone plug, Right angle, Diecast Shell, Black finish, Flexible grommet.</p> | Standard | ACPS-TB |
| | | | | Gold Contacts | ACPS-TB-AU |
| | | | | Bulk Pack | ACPS-TB BULK |





Features:

- Mono or Stereo (TRS).
- Stylish shell design.
- Robust diecast shell in Satin nickel or Black finish.
- Nickel or Gold contact plating.
- Flexible grommet cable protection.
- Improved solderability.
- Precision machined contacts.
- Standard or Bulk packaging.
- Cable OD Entry to 6.5mm (0.256")

Clamp Info:







Cable O.D 3mm to 6.5mm (0.118" to 0.256")

Options: Black Shell, Gold contacts.
Coloured grommets (ordered separately)

Specifications: Page 109

| PRODUCT - FIGURE | DRAWING | DESCRIPTION | VARIATIONS | PART NUMBER |
|------------------|----------------------------------|--|---|---|
| | <p>Dimensions in mm (inches)</p> | 1/4" (6.35mmø) Mono Phone plug, Diecast Shell, Satin finish, Flexible grommet. | Standard Gold Plated Contacts Bulk Pack | ACPM-GN ACPM-GN-AU ACPM-GN BULK |
| | | 1/4" (6.35mmø) Mono Phone plug, Diecast Shell, Black finish, Flexible grommet. | Standard Gold Plated Contacts Bulk Pack | ACPM-GB ACPM-GB-AU ACPM-GB BULK |
| | | 1/4" (6.35mmø) Stereo Phone plug, Diecast Shell, Satin finish, Flexible grommet. | Standard Gold Plated Contacts Bulk Pack | ACPS-GN ACPS-GN-AU ACPS-GN BULK |
| | | 1/4" (6.35mmø) Stereo Phone plug, Diecast Shell, Black finish, Flexible grommet. | Standard Gold Plated Contacts Bulk Pack | ACPS-GB ACPS-GB-AU ACPS-GB BULK |



| PRODUCT - FIGURE | DRAWING | DESCRIPTION | TYPE | PART NUMBER |
|--|---------|--|---------------|--------------|
|  | | <p>1/4" (6.35mmø) Mono Phone plug, Right angle, Diecast Shell, Satin finish, Flexible grommet.</p> | Standard | ACPM-RN |
| | | | Gold contacts | ACPM-RN-AU |
| | | | Bulk Pack | ACPM-RN BULK |
|  | | <p>1/4" (6.35mmø) Mono Phone plug, Right angle, Diecast Shell, Black finish, Flexible grommet.</p> | Standard | ACPM-RB |
| | | | Gold contacts | ACPM-RB-AU |
| | | | Bulk Pack | ACPM-RB BULK |
|  | | <p>1/4" (6.35mmø) Stereo Phone plug, Right angle, Diecast Shell, Satin finish, Flexible grommet.</p> | Standard | ACPS-RN |
| | | | Gold contacts | ACPS-RN-AU |
| | | | Bulk Pack | ACPS-RN BULK |
|  | | <p>1/4" (6.35mmø) Stereo Phone plug, Right angle, Diecast Shell, Black finish, Flexible grommet.</p> | Standard | ACPS-RB |
| | | | Gold contacts | ACPS-RB-AU |
| | | | Bulk Pack | ACPS-RB BULK |



PART NUMBER BREAKDOWN

M / M SERIES II (MUSICIAN RANGE)

E. G. **ACPM-GB-AU BULK**
ACP (Series Prefix), **M**ale, **G**(Shell Type), **B**lack,
 - **AU** (Gold Plated Contacts), **BULK** Packaged.

| | |
|------------------------|--|
| SERIES PREFIX | ACP = Series Prefix |
| CONTACT TYPE | M = 2 pole (Mono) S = 3 pole Tip/Ring/Sleeve (Stereo) |
| SHELL TYPE | G = M Series Straight K = M Series II Straight R = M Series Right Angle T = M Series II Right Angle |
| SHELL FINISH | N = Satin Nickel B = Matt Black |
| CONTACT PLATING | Blank = Nickel Plating AU = Gold Plated |
| PACKAGING | Blank = Individual Bags BULK = Bulk Packed |

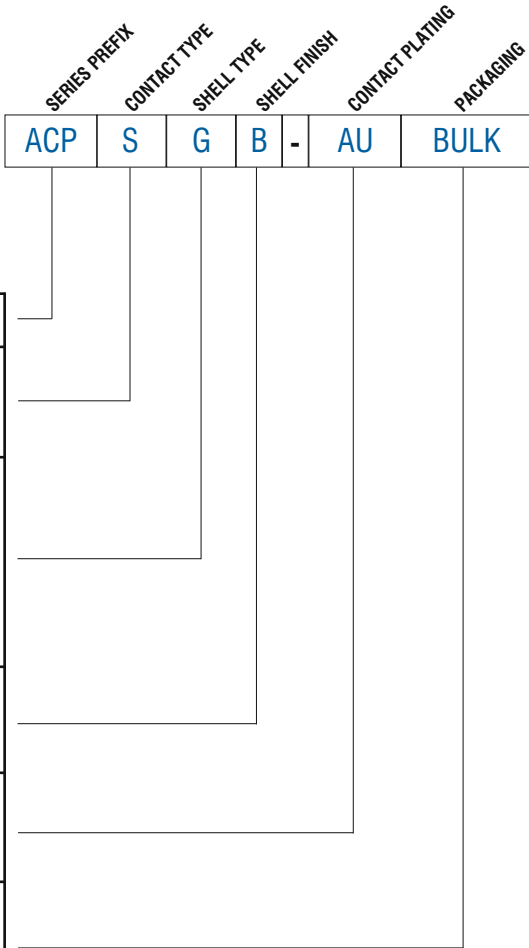



1/4" PHONE JACK CONNECTORS

Amphenol phone connectors are available in 1/4" (6.35mm) and 3.5mm jack sockets or dual jack socket versions featuring combinations of both sizes. The standard heavy duty contacts provide excellent signal performance and the rugged designs excel in professional audio applications. Our wide range of options ensures we have the connector to suit your specific requirements. Custom jacks can also be developed to suit unique applications on request.

Applications

- Audio Cables and Snakes
- Amplifiers
- Speakers
- Mixing desks
- Rack mount equipment
- Patch panel

Features / Options – OEM RANGE Phone Jack

- Mono or Stereo (TRS)
- Stackable (Piggy back) mounting
- Vertical or horizontal PCB mount
- Mono and Stereo switched contacts
- Solder contacts
- Combo Contacts
- Metal nut
- Plastic Nut
- 1/4" (6.35mm)
- 3.5mm
- Dual 1/4" (6.35mm) and 3.5mm
- EMI Shielding plates
- Metal Mounting threads
- Plastic Mounting threads
- Chassis Ground connections
- Half, Full or No threads
- Grounded or Isolated Jacks

1/4" Phone Jack Grounding/ Shielding Options

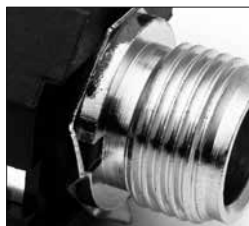

1/4" Gripper - Grounding points



1/4" Shielding Plate

Ordering Codes

We have listed the more common ordering codes in each section. Please contact us if you need any further assistance.

Simple steps to guide you in using this catalogue

- 1) Identify the product group listed in Contents on page 1 and go directly to that page number.
- 2) Each product group cover page then details information and options available.
- 3) Refer to the product detail pages and identify the product you require pictorially.
- 4) Read the product description column for the products standard features.
- 5) Use variations column to determine your choice.
- 6) Identify part number.
- 7) In the event the particular option you require is not listed please refer to the part number breakdown page at the end of each section.
- 8) Please contact us directly if you have any further problems.



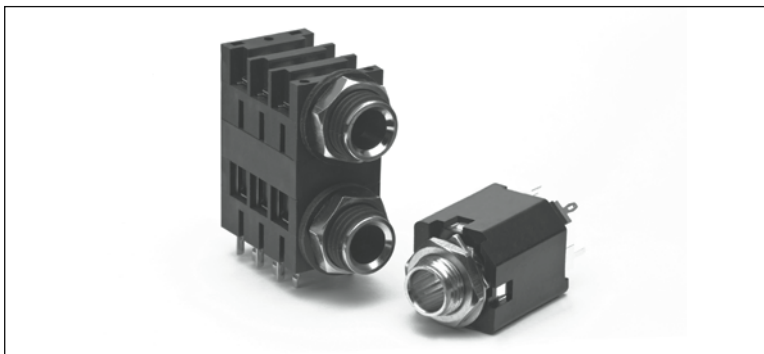

Features:

- 3.5mm and 6.35mm (1/4") options
- Mono or Stereo (TRS)
- Single or Dual mounting
- Vertical or Horizontal PCB mount
- Mono and Stereo with switching contacts
- Solder or Combo contacts
- Various mounting option

Schematic Chart: Page 107

Panel Cutouts: Page 106

PCB Footprints: Page 108

Specifications: Page 109

| PRODUCT - FIGURE | DRAWING | DESCRIPTION | VARIATIONS | PART NUMBER |
|------------------------------------|---------|--|--------------------------------------|---|
| 3.5MM PHONE JACKS | | | | |
| | | 3.5mm Jack, Horizontal PCB, Plastic housing, Metal entry bore | Mono | ACJM-NH35 |
| | | | Stereo | ACJS-NH35 |
| | | 3.5mm Jack, Vertical PCB mount, Needle eye contacts, Plastic housing, Metal entry bore | Refer to Schematic Chart on page 107 | ACJM-NV35-2 ACJM-NV35-2S ACJS-NV35-3 ACJS-NV35-3S ACJS-NV35-5 |
| | | 3.5mm Jack, Vertical PCB mount, Needle eye contacts, Plastic housing, Metal thread and entry bore | Refer to Schematic Chart on page 107 | ACJM-MV35-2 ACJM-MV35-2S ACJS-MV35-3 ACJS-MV35-3S ACJS-MV35-5 |
| | | 3.5mm / 1/4" (6.35mm) Dual Phone Jack, (Piggy-back), Horizontal PCB, Plastic housing, Metal nut and entry bore | Mono | ACJM-MHD985 |
| | | | Stereo | ACJS-MHD985 |
| | | 3.5mm / 1/4" (6.35mm) Dual Phone Jack, Vertical PCB mount, Needle eye contacts, Plastic housing, Metal nut and entry bore | Refer to Schematic Chart on page 107 | ACJM-MVD985-2 ACJM-MVD985-2S ACJS-MVD985-3 ACJS-MVD985-3S ACJS-MVD985-5 |
| 1/4" PHONE JACKS HORIZONTAL | | | | |
| | | 1/4" (6.35mm) Phone Jack, Horizontal Snap-fit PCB, Plastic housing, Half thread, Metal entry bore. Supplied without mounting hardware. | Mono | ACJM-HHDR |
| | | | Stereo | ACJS-HHDR |

| PRODUCT - FIGURE | DRAWING | Dimensions in mm (inches) | DESCRIPTION | VARIATIONS | PART NUMBER |
|------------------|---------|---------------------------|--|--------------------------------------|-------------|
| | | | 1/4" (6.35mmø) Phone Jack, Horizontal Snap-fit PCB, Plastic housing, Metal nut and entry bore | Mono | ACJM-MHDR |
| | | | | Stereo | ACJS-MHDR |
| | | | 1/4" (6.35mmø) Phone Jack, Horizontal Snap-fit PCB, Plastic housing, Metal thread, nut, washer and entry bore | Mono | ACJM-MHDRM |
| | | | | Stereo | ACJS-MHDRM |
| | | | 1/4" (6.35mmø) Offset Jack, Horizontal PCB mount, Plastic housing and entry bore with Half thread. Supplied without mounting hardware. | Refer to Schematic Chart on page 107 | ACJM-HHOP |
| | | | | | ACJS-HHOP |
| | | | 1/4" (6.35mmø) Offset Jack, Horizontal PCB mount, Plastic housing and entry bore with Half thread. Supplied without mounting hardware. | Refer to Schematic Chart on page 107 | ACJM-HHOP-1 |
| | | | | | ACJS-HHOP-1 |
| | | | 1/4" (6.35mmø) Offset Jack, Horizontal PCB mount, Plastic housing, thread and entry bore | Mono - Plastic Nut | ACJM-PHOP |
| | | | | Mono - Metal Nut | ACJM-MHOP |
| | | | | Stereo - Plastic Nut | ACJS-PHOP |
| | | | | Stereo - Metal Nut | ACJS-MHOP |
| | | | 1/4" (6.35mmø) Offset Jack, Horizontal PCB mount, Plastic housing, thread and entry bore. Non-switching sleeve contact with separate grounding to panel. | Refer to Schematic Chart on Page 110 | ACJM-PHOP-1 |
| | | | | PHOP - Denotes Plastic Nut | ACJM-MHOP-1 |
| | | | | MHOP - Denotes Metal Nut | ACJS-PHOP-1 |
| | | | | | ACJS-MHOP-1 |
| | | | 1/4" (6.35mmø) Offset Jack, Horizontal PCB mount, Plastic housing, Metal thread and entry bore with Chassis ground connection | Mono - Metal Nut | ACJM-MHOM |
| | | | | Stereo - Metal Nut | ACJS-MHOM |
| | | | 1/4" (6.35mmø) Jack, Horizontal PCB mount, Plastic housing with metal insert | Mono - Plastic Nut | ACJM - PH |
| | | | | Mono - Metal Nut | ACJM - MH |



| PRODUCT - FIGURE | DRAWING | Dimensions in mm (inches) | DESCRIPTION | VARIATIONS | PART NUMBER |
|---|------------|---------------------------|--|----------------------|-------------|
| | | | 1/4" (6.35mmø) Jack, Horizontal PCB mount, Plastic housing with metal insert | Stereo - Plastic Nut | ACJS - PH |
| | | | | Stereo - Metal Nut | ACJS - MH |
| | | | 1/4" (6.35mmø) Jack, Horizontal Snap-fit PCB mount, Plastic housing with metal insert | Mono - Plastic Nut | ACJM-PHR |
| | | | | Mono - Metal Nut | ACJM-MHR |
| | | | | Stereo - Plastic Nut | ACJS-PHR |
| | | | | Stereo - Metal Nut | ACJS-MHR |
| | | | 1/4" (6.35mmø) Jack, Combination Horizontal PCB mount and Solder lug, Plastic housing with metal insert | Mono - Plastic Nut | ACJM-PC |
| | | | | Mono - Metal Nut | ACJM-MC |
| | | | | Stereo - Plastic Nut | ACJS-PC |
| | | | | Stereo - Metal Nut | ACJS-MC |
| | | | 1/4" (6.35mmø) Jack, Solder Lug, Plastic housing with metal insert | Mono - Plastic Nut | ACJM-PHS |
| | | | | Mono - Metal Nut | ACJM-MHS |
| | | | | Stereo - Plastic Nut | ACJS-PHS |
| | | | | Stereo - Metal Nut | ACJS-MHS |
| | | | 1/4" (6.35mmø) Jack, Solder Lug, Plastic housing and Bezel with threaded Metal nut. | Mono | ACJM-IHS |
| | | | | Stereo | ACJS-IHS |
| | | | 1/4" (6.35mmø) Jack, Horizontal PCB mount, Plastic housing and Bezel with threaded Metal nut. | Mono | ACJM-IH |
| | | | | Stereo | ACJS-IH |
| 1/4" PHONE JACKS HORIZONTAL DUAL | | | 1/4" (6.35mmø) Dual Phone Jack (Compact Piggyback), Horizontal Snap-fit PCB, Plastic housing, Metal nut and entry bore | Mono | ACJM-MHDC* |
| | | | | Stereo | ACJS-MHDC* |
| | | | | | |
| Stereo | ACJS-MHDCM | | | | |

| PRODUCT - FIGURE | DRAWING | DESCRIPTION | VARIATIONS | PART NUMBER |
|----------------------------------|-------------|--|--------------------------------------|-------------|
| | | 1/4" (6.35mmØ) Dual Phone Jack (Piggyback) Horizontal Snap-fit PCB, Plastic housing, Metal nut and entry bore | Mono | ACJM-MHD* |
| | | | Stereo | ACJS-MHD* |
| | | 1/4" (6.35mmØ) Dual Phone Jack (Piggyback) Shielding plate, Horizontal Snap-fit PCB, Plastic housing, Metal nut and entry bore | Mono | ACJM-MHDE* |
| | | | Stereo | ACJS-MHDE* |
| | | 1/4" (6.35mmØ) Dual Phone Jack (Piggyback), Horizontal Snap-fit PCB, Plastic housing, Metal thread, washer and entry bore | Mono | ACJM-MHDM* |
| | | | Stereo | ACJS-MHDM* |
| | | 1/4" (6.35mmØ) Dual Phone Jack (Piggyback), Shielding plate Horizontal Snap-fit PCB, Plastic housing, Metal thread, nut and entry bore | Mono | ACJM-MHDEM* |
| | | | Stereo | ACJS-MHDEM* |
| 1/4" PHONE JACKS VERTICAL | | 1/4" (6.35mmØ) Jack, Vertical PCB mount, Plastic housing, nut and entry bore | Refer to Schematic Chart on page 107 | ACJM-PVB-2 |
| | ACJM-PVB-2S | | | |
| | ACJS-PVB-3 | | | |
| | ACJS-PVB-3S | | | |
| | ACJS-PVB-5 | | | |
| | | 1/4" (6.35mmØ) Jack, Vertical PCB mount, Needle eye contacts, Plastic thread, Metal nut and insert | Refer to Schematic Chart on page 107 | ACJM-MIV-2 |
| | | | | ACJM-MIV-2S |
| | | | | ACJS-MIV-3 |
| | | | | ACJS-MIV-3S |
| | | | | ACJS-MIV-5 |
| | | 1/4" (6.35mmØ) Jack, Vertical PCB mount, Needle eye contacts, Star washer, Metal nut and insert | Refer to Schematic Chart on page 107 | ACJM-MN-2 |
| | | | | ACJS-MN-3 |
| | | | | ACJM-MN-2S |
| | | | | ACJS-MN-3S |
| | | | | ACJS-MN-5 |
| | | 1/4" (6.35mmØ) Jack, Vertical PCB mount, Metal nut and insert | Refer to Schematic Chart on page 107 | ACJM-MV-2 |
| | | | | ACJM-MV-2S |
| | | | | ACJS-MV-3 |
| | | | | ACJS-MV-3S |
| | | | | ACJS-MV-5 |

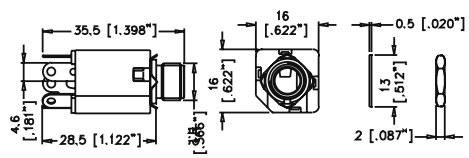

| PRODUCT - FIGURE | DRAWING | DESCRIPTION | VARIATIONS | PART NUMBER |
|---|---|--|--------------------------------------|--|
|  |  | 1/4" (6.35mm) Jack, Solder Lug, Metal nut and insert | Refer to Schematic Chart on Page 110 | ACJM-MVS-2 ACJM-MVS-2S ACJS-MVS-3 ACJS-MVS-3S ACJS-MVS-5 |

PANEL CUTOUTS -FRONT VIEW

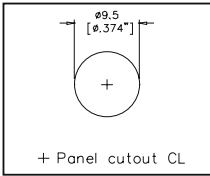

ACJM-MV
ACJS-MV
ACJM-MN-2
ACJS-MN-3
ACJM-MN-2S
ACJS-MN-3S
ACJS-MN-5
ACJM-MIV
ACJS-MIV
ACJM-MVS
ACJS-MVS

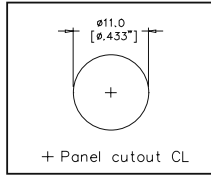

ACJM/S-PH
ACJM/S-MH
ACJM/S-PC
ACJM/S-MC
ACJM/S-PHR
ACJM/S-MHR
ACJM/S-PHS
ACJM/S-MHS

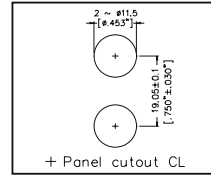

ACJM-MHD
ACJS-MHD
ACJM-MHDE
ACJS-MHDE

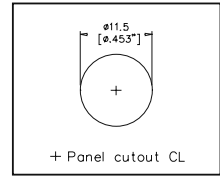

ACJM-MHDR
ACJS-MHDR
ACJS-HHDR

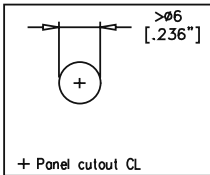

ACJM-NH35
ACJS-NH35

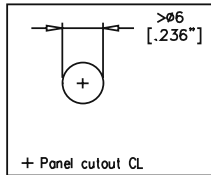

ACJM-NV35-2
ACJM-NV35-2S
ACJS-NV-35-3
ACJS-NV-35-3S
ACJS-NV-35-5
ACJM-MV35-2
ACJM-MV35-2S
ACJS-MV-35-3
ACJS-MV-35-3S
ACJS-MV-35-5

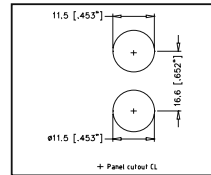

ACJS-MHDC
ACJM-MHDC

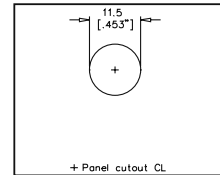

ACJS-IH
ACJM-IH
ACJS-IHS
ACJM-IHS

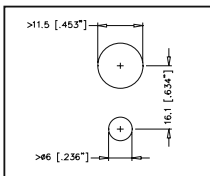

ACJM-MHD985
ACJM-MHD985

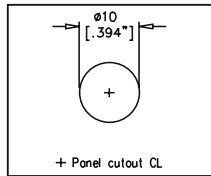

ACJM-MHOM
ACJM-MHOM

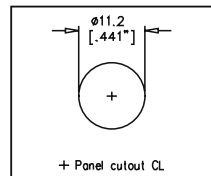

ACJM-MHOP
ACJS-MHOP
ACJM-MHOP
ACJS-MHOP-1
ACJS-MHOP-1
ACJM-MHOP-1
ACJS-MHOP-1
ACJM-MHOP-1
ACJS-MHOP-1
ACJM-MHOP-1
ACJS-MHOP-1
ACJM-MHOP-1
ACJS-MHOP-1

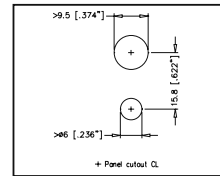

ACJM-MVD985
ACJM-MVD985

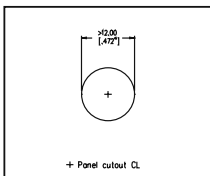

ACJM-PVB-2
ACJM-PVB-2S
ACJS-PVB-3
ACJS-PVB-3S
ACJS-PVB-5

SCHEMATIC CHART

| PART NO. | ACJM-MV35-2 ACJM-MN-2 ACJM-NV35-2 ACJM-PVB-2 ACJM-MV-2 ACJM-MVS-2 ACJM-MIV-2 | ACJM-MV35-2S ACJM-MN-2S ACJM-NV35-2S ACJM-PVB-2S ACJM-MV-2S ACJM-MVS-2S ACJM-MIV-2S | ACJS-MV35-3 ACJS-MN-3 ACJS-NV35-3 ACJS-PVB-3 ACJS-MV-3 ACJS-MVS-3 ACJS-MIV-3 | ACJS-MV35-3S ACJS-MN-3S ACJS-NV35-3S ACJS-PVB-3S ACJS-MV-3S ACJS-MVS-3S ACJS-MIV-3S | ACJS-MV35-5 ACJS-MN-5 ACJS-NV35-5 ACJS-PVB-5 ACJS-MV-5 ACJS-MVS-5 ACJS-MIV-5 |
|-------------------|--|---|--|---|--|
| GENERAL SCHEMATIC | | | | | |

| PART NO. | ACJM-MVD985-2 | ACJM-MVD985-2S | ACJS-MVD985-3 | ACJS-MVD985-3S | ACJS-MVD985-5 |
|-----------|---------------|----------------|---------------|----------------|---------------|
| SCHEMATIC | | | | | |

| PART NO. | ACJM-HHOP-1 ACJM-PHOP-1 ACJM-MHOP-1 | ACJS-HHOP-1 ACJS-PHOP-1 ACJS-MHOP-1 | ACJM-HHOP ACJM-PHOP ACJM-MHOP | ACJS-HHOP ACJS-PHOP ACJS-MHOP |
|-------------------|---|---|-------------------------------------|-------------------------------------|
| GENERAL SCHEMATIC | | | | |



PCB FOOTPRINT - CONNECTOR SIDE OF PCB

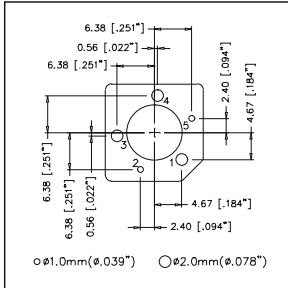

ACJM-MV
ACJS-MV
ACJM-MN-2
ACJS-MN-3
ACJM-MN-2S
ACJS-MN-3S
ACJM-MN-5
ACJS-MN-5
ACJM-NV35-XX
ACJS-NV35-XX
ACJM-MIV-2
ACJS-MIV-3
ACJM-MIV-2S
ACJS-MIV-3S
ACJM-MIV-3
ACJS-MIV-5

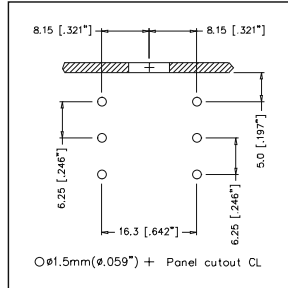

ACJM-PH
ACJM-MH
ACJS-PH
ACJM-MH
ACJM-PC
ACJM-MC
ACJS-PC
ACJS-MC

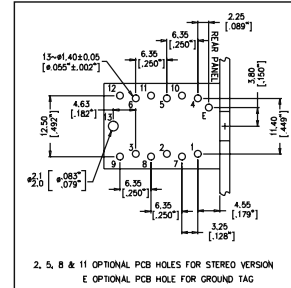

ACJM-MHD
ACJS-MHD
ACJM-MHDE
ACJS-MHDE
ACJM-MHDEM
ACJS-MHDEM
ACJM-MHDC
ACJS-MHDC
ACJM-MHDCM
ACJS-MHDCM
ACJM-MHDM
ACJS-MHDM

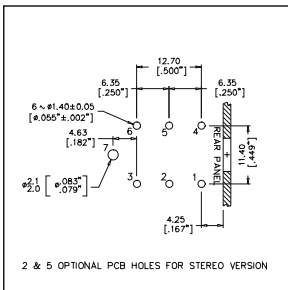

ACJM-MHDR
ACJS-MHDR
ACJM-PHR
ACJM-MHR
ACJS-PHR
ACJS-MHR
ACJM-HHDR
ACJS-HHDR
ACJM-MHDM
ACJS-MHDM

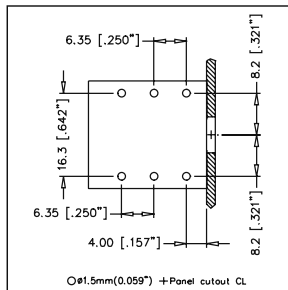

ACJS-IH
ACJM-IH

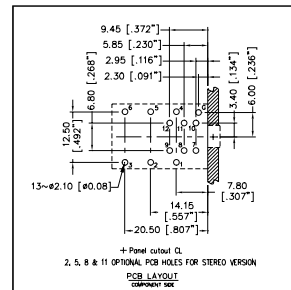

ACJS-MHD985
ACJM-MHD985

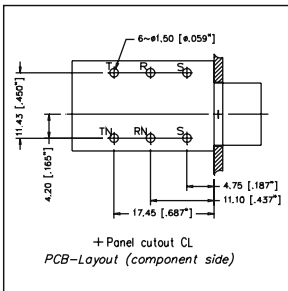

ACJS-MHOM
ACJM-MHOM

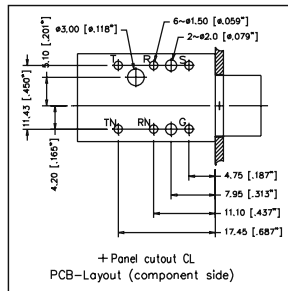

ACJS-MHOP-1
ACJS-PHOP-1
ACJS-HHOP-1
ACJM-MHOP-1
ACJM-PHOP-1
ACJM-HHOP-1

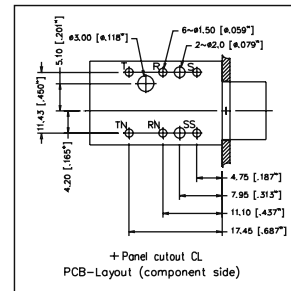

ACJS-MHOP
ACJS-PHOP
ACJM-MHOP
ACJM-PHOP
ACJM-HHOP
ACJS-HHOP

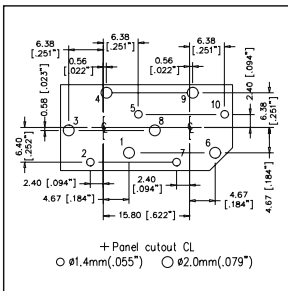

ACJS-MVD985
ACJM-MVD985

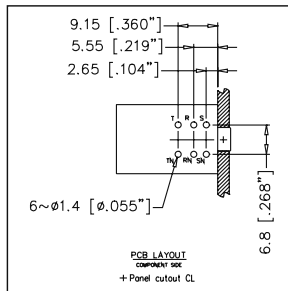

ACJS-NH35
ACJM-NH35

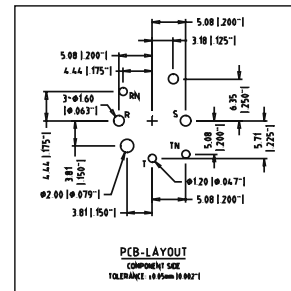

ACJM-PVB-2
ACJS-PVB-2S
ACJS-PVB-3
ACJS-PVB-3S
ACJM-PVB-5

1/4" PLUGS TECHNICAL DATA

| | | VALUE |
|-----------------------------------|---|--|
| GENERAL CHARACTERISTICS | Number of Contacts | 2 Pole (Mono) 3 Pole Tip Ring Sleeve (Stereo) |
| | Termination | Solder |
| | Max. Wire Gauge - Stranded Wire | 2 Pole (Mono): AWG 16 ~ 1.5mm ² 3 Pole (Stereo): AWG 18 ~ 1mm ² |
| | Flammability rating of insulating plastics | UL94V-0 |
| | Solderability, complies with | IEC 68-2-20 |
| | Environmental | Complies with EU RoHS 2 Directive 2011/65/EU |
| ELECTRICAL CHARACTERISTICS | Current Carrying Capacity | 10A (Depends on Mating Connector and Cable) |
| | Typical Contact Resistance | Depends on Mating Connector |
| | Insulation resistance (initial) After Damp Heat Test | > 2GΩ ≥ 1GΩ |
| | Dielectric Withstand Voltage | 2 Pole : 1.5 kV dc 3 Pole : 1 kV dc |
| CLIMATIC CHARACTERISTICS | Protection Class | IP40 |
| | Operating Temperature | -25°C to +70°C (-13°F to 158°F) |
| MECHANICAL CHARACTERISTICS | Insertion and Withdrawal Force | ≥ 10N - ≤ 30N |
| | Mating Cycles | Min. of 1000 cycles without any physical damage |
| | Cable O.D. - M Series - M Series II | 3mm to 6.5mm (0.118" to 0.256") 6.5mm to 8mm (0.256" to 0.315") |
| MATERIALS | Connector Shell Material | Diecast Zinc Alloy EZDA No.3 |
| | Connector Shell Finish | Satin Nickel or Black Polyester |
| | Insulators | UL94 V-0 PBT Resin or Modified PPE Resin and fibreglass laminate |
| | Cable Bushing | Santoprene |
| | Contact Plating | Brass / Ni over Cu (Copper) |

Rev 4 - 05/2014

¹⁾Approximate weight only, does not include packaging. Please contact us for exact weight for shipping purposes.



1/4" JACKS TECHNICAL DATA

| | | VALUE |
|-----------------------------------|---|--|
| GENERAL CHARACTERISTICS | Number of Contacts | 2 Pole (Mono) 3 Pole Tip Ring Sleeve (Stereo) |
| | Termination | Solder, PCB or Combo |
| | Flammability rating of insulating plastics | UL94V-0 |
| | Solderability, complies with | IEC 68-2-20 |
| | Environmental | Complies with EU RoHS 2 Directive 2011/65/EU |
| ELECTRICAL CHARACTERISTICS | Current Carrying Capacity | 10A (Depends on Mating Connector and Cable) |
| | Typical Contact Resistance | ≤10mΩ |
| | Insulation resistance (initial) After Damp Heat Test | >2GΩ ≥10 ³ Meg Ω |
| | Rated Voltage Test Voltage AC RMS: Dielectric Strength | 34V 500V |
| CLIMATIC CHARACTERISTICS | Protection Class | IP40 |
| | Operating Temperature | -25°C to +70°C (-13°F to 158°F) |
| MECHANICAL CHARACTERISTICS | Insertion and Withdrawal Force | ≥10N - ≤30N |
| | Mating Cycles | Min. of 1000 cycles without any physical damage |
| | Weight - Straight - Right Angle | 18g (0.039lb) 25g (0.055lb) |
| MATERIALS | Connector Shell Material | Nylon PA66 30% Glass Filled |
| | Insulators | UL94 V-0 PBT Resin or Modified PPE Resin and fiberglass laminate |
| | Metal Nut | Brass |
| | Plastic Nut | Nylon PA66 30% Glass Filled |
| | Washer | Fiber / Brass / Nylon PA66 30% Glass Filled |
| | Contact Plating | Tin - 4μm Min. over 2μm Min.Cu (Copper) Silver - 0.3μm Min. over 2μm Min.Cu (Copper) Nickel - 2μm Min. over 2μm Min.Cu (Copper) Gold Flash - 0.05μm Min. over 2μm Min.Cu (Copper) |
| | Contacts | Brass / Sn (Tin) over Cu (Copper) |

Rev 4 - 05/2014

¹Approximate weight only, does not include packaging. Please contact us for exact weight for shipping purposes.





PLUGS AND SOCKETS

Amphenol's plugs and sockets range continually expands to meet the needs of our customers. The success of the M-Series phone plugs led to the RCA series being developed. The Miniature XLR range was a natural progression from our standard XLR series as demand for smaller interconnects increased. The latest addition to the range is a professional grade 3.5mm phone plug designed for applications that require a robust interconnect.

Applications

- Audio Cables and Snakes
- Amplifiers
- Speakers
- Mixing desks
- Rack mount equipment
- Patch panel

Features / Options – RCA Plugs and Jacks

- Red, Black, White, Yellow, Blue or Green shell colours
- Stylish shell design
- Flexible grommet cable protection
- Gold Plated Contacts

Features / Options – Miniature XLR

- 3,4,5, or 6 contacts
- Solder cup
- Printed Circuit Board
- Vertical or Horizontal mounting
- Positive locking latch
- Flexible cable clamp
- Metal cable clamp
- Locking rings
- Chassis front mount
- Chassis middle or rear mount (on request)
- Optional black finish (on request)

Features / Options – 3.5mm Plugs Phone Jack

- Mono / Stereo TRS
- Solder contacts
- Suits cable O.D 2.5mm to 5mm
- Stylised shell design
- Flexible cable grommet
- Metal cable clamp
- Nickel or Gold contact plating
- Satin Nickel or Black finish

Cable Clamp Options



RCA Cable Clamp - M-Series, Cable O.D 3mm to 6.5mm (0.118" to 0.256")

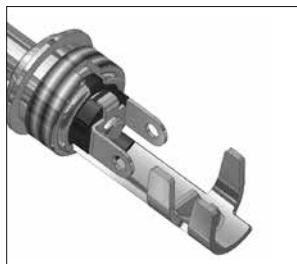

K-Series, Cable O.D 3mm to 5mm (0.118" to 0.196")

Ordering Codes

We have listed the more common ordering codes in each section. Please contact us if you need any further assistance.

Simple steps to guide you in using this catalogue

- 1) Identify the product group listed in Contents on page 1 and go directly to that page number.
- 2) Each product group cover page then details information and options available.
- 3) Refer to the product detail pages and identify the product you require pictorially.
- 4) Read the product description column for the products standard features.
- 5) Use variations column to determine your choice.
- 6) Identify part number.
- 7) In the event the particular option you require is not listed please refer to the part number breakdown page at the end of each section.
- 8) Please contact us directly if you have any further problems.



3.5mm K-SERIES



Features:

- Mono or TRS (Stereo).
- AX Series inspired shell design.
- Suits Cable O.D from 2.5mm to 5mm (0.098" to 0.196")
- Robust diecast shell in Satin nickel or Black finish.
- Nickel or Gold contact plating.
- Flexible grommet cable protection.
- Improved solderability.
- Precision machined contacts.
- Standard or Bulk packaging.

Options: Black Shell, Gold contacts.

| PRODUCT - FIGURE | DRAWING | Dimensions in mm (inches) | DESCRIPTION | VARIATIONS | PART NUMBER |
|------------------|---------|--|--|---|---------------------------------|
| | | 49 [1.911"] 35 [1.370"] ø10.3 [ø.406"] | 3.5mm, Mono Phone plug, Diecast Shell, Satin finish, Flexible grommet. | Standard Gold Plated Contacts Bulk Pack | KM2P KM2P-AU KM2P BULK |
| | | 49 [1.911"] 35 [1.370"] ø10.3 [ø.406"] | 3.5mm, Mono Phone plug, Diecast Shell, Black finish, Flexible grommet. | Standard Gold Plated Contacts Bulk Pack | KM2PB KM2PB-AU KM2PB BULK |
| | | 49 [1.911"] 35 [1.370"] ø10.3 [ø.406"] | 3.5mm, Stereo Phone plug, Diecast Shell, Satin finish, Flexible grommet. | Standard Gold Plated Contacts Bulk Pack | KS3P KS3P-AU KS3P BULK |
| | | 49 [1.911"] 35 [1.370"] ø10.3 [ø.406"] | 3.5mm, Stereo Phone plug, Diecast Shell, Black finish, Flexible grommet. | Standard Gold Plated Contacts Bulk Pack | KS3PB KS3PB-AU KS3PB BULK |
| | | 51 [2.008"] 37 [1.467"] 3.10 [.122"] ø10.3 [ø.406"] | 3.5mm, Stereo Phone plug with extended shaft for mobile phones fitted with covers. Diecast Shell, Black Chrome finish, Flexible grommet | Standard Gold Plated Contacts | KS3PC KS3PC-AU |



PART NUMBER BREAKDOWN

K-SERIES

E. G. **KS3P-AU BULK**
K (Series Prefix), **S3** (Stereo), Plug,
AU (Gold Plated Contacts), **Bulk** Packaged.

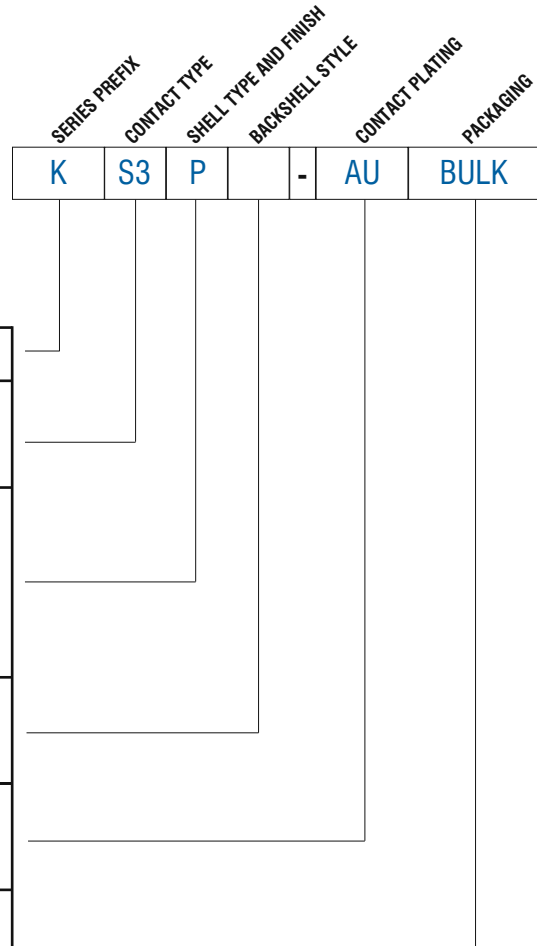

| | | | |
|---------------------------------------|-------|---|--|
| SERIES PREFIX | K | = | Series Prefix |
| CONTACT TYPE | M2 | = | 2 Pole (mono) |
| | S3 | = | 3 pole TRS (Stereo) |
| SHELL TYPE AND FINISH | P | = | Plug Satin Nickel |
| | PB | = | Plug Matt Black |
| | PC | = | Plug Black Chrome |
| BACKSHELL TYPE AND CABLE CLAMP | Blank | = | K Series to suit Cable O.D 2.5mm to 5mm (0.098" to 0.196") |
| CONTACT PLATING | Blank | = | Nickel Plated Contacts (Standard) |
| | AU | = | Gold Plated Contacts |
| PACKAGING | Blank | = | Individual Bags |
| | BULK | = | Bulk Packed |

ISO VIEW OF KS3P

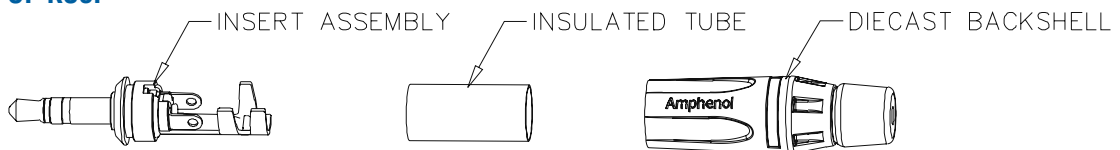

3.5mm PLUG TECHNICAL DATA

| | | VALUE |
|-----------------------------------|---|--|
| GENERAL CHARACTERISTICS | Number of Contacts | 2 Pole (Mono) 3 Pole Tip Ring Sleeve (Stereo) |
| | Termination | Solder |
| | Wire Gauge - Stranded Wire | 2 Pole (Mono): AWG 16 - 1.5mm ² 3 Pole (Stereo): AWG 18 - 1mm ² |
| | Flammability rating of insulating plastics | UL94V-0 |
| | Solderability, complies with | IEC 68-2-20 |
| | Environmental | Complies with EU RoHS 2 Directive 2011/65/EU |
| ELECTRICAL CHARACTERISTICS | Current Carrying Capacity | >0.5mA (Depends on Mating Connector and Cable) |
| | Typical Contact Resistance | ≤20mΩ (Depends on Mating Connector and Cable) |
| | Insulation resistance (initial) After Damp Heat Test | >200M Ω >100M Ω |
| | Test Voltage AC RMS: Dielectric Strength | 250VAC |
| CLIMATIC CHARACTERISTICS | Protection Class | IP40 |
| | Operating Temperature | -20°C to +65°C (-4°F to +149°F) |
| MECHANICAL CHARACTERISTICS | Insertion and Withdrawal Force | <20N / >3N (depends on mating connector) |
| | Cable O.D. | 3mm to 5mm (0.118" to 0.196") |
| | Mechanical Operations | 1000 mating cycles |
| | Weight | 8g (0.017lb) |
| MATERIALS | Connector Shell Material (Plugs) | Diecast Zinc Alloy EZDA No.3 |
| | Connector Shell Finish | Satin Nickel or Black Polyester |
| | Insulators | PA66 |
| | Cable Bushing | Santoprene |
| | Contacts | Brass |
| | Plating | Nickel or Gold Flash |

¹ Approximate weight only, does not include packaging. Please contact us for exact weight for shipping purposes.



RCA SERIES



Features:

- Stylish design
- Flexible grommet cable protection
- Robust diecast shell
- Gold plated contacts
- Colour coded
- Good solderability
- Quick and easy assembly
- Panel mount utilises standard 'D' type housing

Part Number Breakdown: Page 116

| PRODUCT - FIGURE | DRAWING | Dimensions in mm (inches) | DESCRIPTION | VARIATIONS | PART NUMBER |
|------------------|---------|---------------------------------|---|----------------|-------------|
| | | 62 [2.445"] ø13.8 [.543"] | RCA Plug, Diecast Shell, Gold plated contacts, Coloured finish, Flexible coloured grommet | Red | ACPR-RED |
| | | | | Black | ACPR-BLK |
| | | | | Yellow | ACPR-YEL |
| | | | | White | ACPR-WHT |
| | | | | Blue | ACPR-BLU |
| | | 62 [2.445"] ø13.8 [.543"] | RCA Plug, Diecast Shell, Gold plated contacts, Satin finish, Flexible coloured grommet | Satin / Red | ACPR-SRD |
| | | | | Satin / Black | ACPR-SBK |
| | | | | Satin / Yellow | ACPR-SYL |
| | | | | Satin / White | ACPR-SWH |
| | | | | Satin / Blue | ACPR-SBL |
| | | 54 [2.130"] ø13.8 [.543"] | RCA Jack, Diecast Shell, Gold plated contacts, Coloured finish, Flexible coloured grommet | Red | ACJR-RED |
| | | | | Black | ACJR-BLK |
| | | | | Yellow | ACJR-YEL |
| | | | | White | ACJR-WHT |
| | | | | Blue | ACJR-BLU |
| | | 54 [2.130"] ø13.8 [.543"] | RCA Jack, Diecast Shell, Gold plated contacts, Satin finish, Flexible coloured grommet | Satin / Red | ACJR-SRD |
| | | | | Satin / Black | ACJR-SBK |
| | | | | Satin / Yellow | ACJR-SYL |
| | | | | Satin / White | ACJR-SWH |
| | | | | Satin / Blue | ACJR-SBL |
| | | 50.5 [1.988"] ø13.8 [ø.543"] | RCA Plug, Shortened Diecast Shell, Gold plated contacts, Black Chrome finish, Flexible coloured grommet | Red | ACPL-CRD |
| | | | | Black | ACPL-CBK |
| | | | | Yellow | ACPL-CYL |
| | | | | White | ACPL-CWH |
| | | | | Blue | ACPL-CBL |
| | | | | Green | ACPL-CGR |

NOTE: RCA Series comply with EU RoHS 2 Directive 2011/65/EU

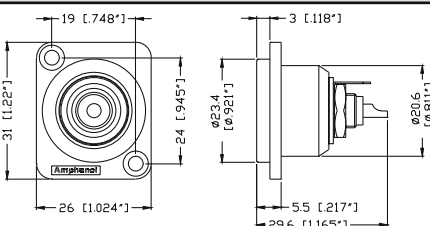

| PRODUCT - FIGURE | DRAWING | Dimensions in mm (inches) | DESCRIPTION | VARIATIONS | PART NUMBER |
|---|---|---------------------------|---|--|--|
|  |  | | RCA Jack, Diecast Shell, Gold plated contacts, Nickel finish shell, coloured insulator. | <ul style="list-style-type: none"> Red Black Yellow White Blue Green | <ul style="list-style-type: none"> ACJD-RED ACJD-BLK ACJD-YEL ACJD-WHT ACJD-BLU ACJD-GRN |

NOTE: RCA Series comply with EU RoHS 2 Directive 2011/65/EU

PART NUMBER BREAKDOWN

M SERIES RCA

E. G. **ACPR-RED BULK**
AC (Series Prefix), **P** (Plug), **R** (Shell type), **RED** (Shell and Grommet Colour), **Bulk** Packaged.

| SERIES PREFIX | CONTACT TYPE | SHELL TYPE | SHELL FINISH | PACKAGING | |
|---------------|--------------|------------|--------------|-----------|------|
| AC | P | R | - | RED | BULK |

| | | | |
|---------------------------------|---|---|------------------------------|
| SERIES PREFIX | AC | = | Series Prefix |
| CONTACT TYPE | J | = | RCA Female Jack |
| | P | = | RCA Male Plug |
| SHELL TYPE | R | = | Regular Shell Length |
| | L | = | Short Shell Length |
| | D | = | Chassis Jack 'D' Shell |
| SHELL AND GROMMET COLOUR | RED | = | Red, Red Grommet |
| | BLK | = | Black, Black Grommet |
| | YEL | = | Yellow, Yellow Grommet |
| | WHT | = | White, White Grommet |
| | BLU | = | Blue, Blue Grommet |
| | GRN | = | Green, Green Grommet |
| | SRD | = | Satin Nickel, Red Grommet |
| | CRD | = | Black Chrome, Red Grommet |
| | SBK | = | Satin Nickel, Black Grommet |
| | CBK | = | Black Chrome, Black Grommet |
| | SYL | = | Satin Nickel, Yellow Grommet |
| | CYL | = | Black Chrome, Yellow Grommet |
| | SWH | = | Satin Nickel, White Grommet |
| | CWH | = | Black Chrome, White Grommet |
| | SBL | = | Satin Nickel, Blue Grommet |
| | CBL | = | Black Chrome, Blue Grommet |
| | SGR | = | Satin Nickel, Green Grommet |
| | CGR | = | Black Chrome, Green Grommet |
| | NOTE: Denotes colour of insulator only on shell type D, Chassis Jack 'D' Shell. Shell finish is Nickel. | | |
| PACKAGING | Blank | = | Individual Bags |
| | BULK | = | Bulk Packed |

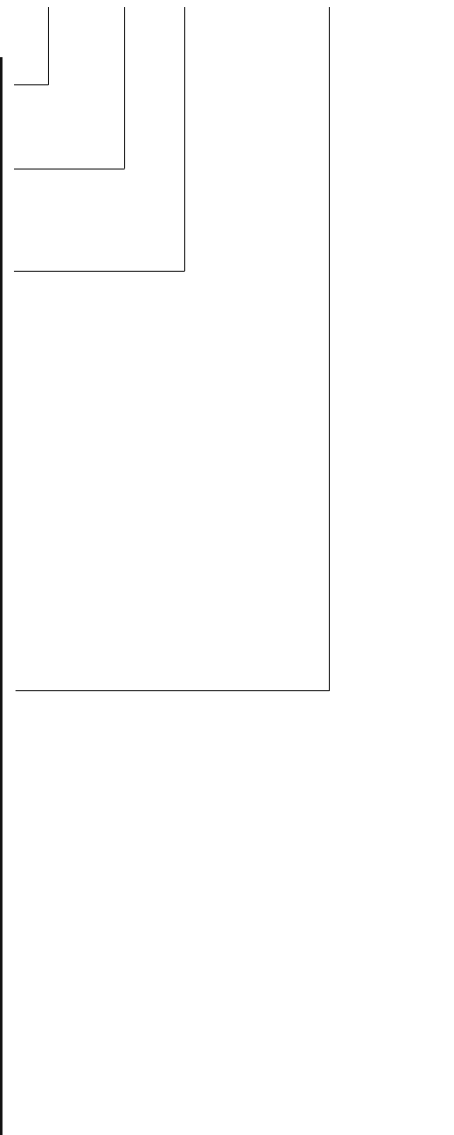

RCA TECHNICAL DATA

| | | VALUE |
|-----------------------------------|---|--|
| GENERAL CHARACTERISTICS | Number of Contacts | 2 |
| | Termination | Solder |
| | Max. Wire Gauge - Stranded Wire | AWG 14 - 2.5mm ² |
| | Flammability rating of insulating plastics | UL94V-0 |
| | Solderability, complies with | IEC 68-2-20 |
| | Environmental | Complies with EU RoHS 2 Directive 2011/65/EU |
| ELECTRICAL CHARACTERISTICS | Current Carrying Capacity | 10A (Depends on Mating Connector) |
| | Typical Contact Resistance | ≤10mΩ (Depends on Mating Connector) |
| | Insulation resistance (initial) After Damp Heat Test | > 2GΩ ≥ 10 ³ Meg Ω |
| | Dielectric Strength | 1500 V dc |
| CLIMATIC CHARACTERISTICS | Protection Class | IP40 |
| | Operating Temperature | -25°C to +75°C (-13°F to +167°F) |
| MECHANICAL CHARACTERISTICS | Insertion and Withdrawal Force | ≥10N - ≤30N (depends on mating connector) |
| | Cable O.D. | 3mm to 7mm (0.118" to 0.275") |
| | Mechanical Operations | 500 mating cycles |
| | Weight - Cable Mount - Panel Mount | 18g (0.039lb) 30g (0.066lb) |
| MATERIALS | Connector Shell Material (Plugs) | Diecast Zinc Alloy EZDA No.3 |
| | Connector Shell Finish | Satin Nickel or Coloured Polyester |
| | Insulators | PA66 |
| | Cable Bushing | Thermoplastic Polyurethane |
| | Contacts | Brass Alloy |
| | Plating | Gold Flash |

Rev 4 - 05/2014

¹⁾Approximate weight only, does not include packaging. Please contact us for exact weight for shipping purposes.







Features:

- Miniature version of the standard XLR series
- Diecast or Precision machined metal housings
- Metal cable clamp
- Precision machined pin contacts
- Stamped socket contacts
- Solder cup or Printed Circuit board contacts
- Available in 3, 4, 5 or 6 contacts
- Postive latchlock
- Flexible cable grommet

Part Number Breakdown: Page 119 Specifications: Page 120
PCB Footprints: Page 121 Panel Cutouts: Page 121

| PRODUCT - FIGURE | DRAWING | DESCRIPTION | VARIATIONS | PART NUMBER |
|------------------|---------|--|--------------------------------------|--|
| | | Male cable connector, Machined contacts, Nickel Finish | 3 pole 4 pole 5 pole 6 pole | AG3M AG4M AG5M AG6M |
| | | Female cable connector, Stamped contacts, Nickel Finish | 3 pole 4 pole 5 pole 6 pole | AG3F AG4F AG5F AG6F |
| | | Female cable connector with locking ring, Stamped contacts, Nickel Finish. | 3 pole 4 pole 5 pole 6 pole | AG3FL AG4FL AG5FL AG6FL |
| | | Male chassis connector, Machined contacts, Nickel Finish | 3 pole 4 pole 5 pole 6 pole | AG3MCC AG4MCC AG5MCC AG6MCC |
| | | Female chassis connector, Stamped contacts, Nickel Finish | 3 pole 4 pole 5 pole 6 pole | AG3FCE AG4FCE AG5FCE AG6FCE |
| | | Male chassis connector, Horizontal PCB, Machined contacts, Nickel Finish | 3 pole 4 pole 5 pole 6 pole | AG3MCCH AG4MCCH AG5MCCH AG6MCCH |
| | | Female chassis connector, Horizontal PCB, Stamped contacts, Nickel Finish | 3 pole 4 pole 5 pole 6 pole | AG3FCCH AG4FCCH AG5FCCH AG6FCCH |

Amphenol

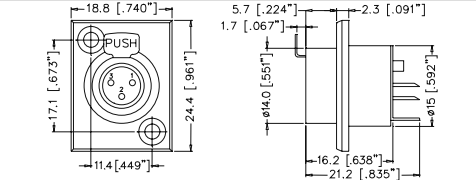
| | | | | |
|---|---|---|---------------|----------------|
|  |  | <p>Male chassis connector, Horizontal PCB, Machined contacts, Thermoplastic shell</p> | <p>4 pole</p> | <p>AG4MPCH</p> |
|  |  | <p>Female chassis connector, Stamped contacts, Nickel Finish</p> | <p>3 pole</p> | <p>AG3FCRV</p> |
| | | | <p>4 pole</p> | <p>AG4FCRV</p> |
| | | | <p>5 pole</p> | <p>AG5FCRV</p> |
| | | | <p>6 pole</p> | <p>AG6FCRV</p> |

PART NUMBER BREAKDOWN

G TYPE CONNECTORS

E. G. **AG3MCCHB**
AG (Series Prefix), **3** contacts, **Male**, **Chassis Connector**, **Horizontal PCB Contacts**, **Black finish**.

| | | | |
|------------------------|-------|---|---|
| SERIES PREFIX | AG | = | Series Prefix |
| CONTACT LAYOUTS | 3 | = | 3 Contacts |
| | 4 | = | 4 Contacts |
| | 5 | = | 5 Contacts |
| | 6 | = | 6 Contacts |
| GENDER | F | = | Female Socket Contacts |
| | M | = | Male Pin Contacts |
| | Blank | = | Cable Connector Standard (Male or Female) |
| SHELL STYLE | J | = | Cable Connector Large Cable clamp / boot O.D (Male or Female) |
| | L | = | Cable Connector with locking ring (Female) |
| | LL | = | Latchless (Chassis Connector) |
| | CC | = | Chassis Connector Circular Metal (Male) |
| | CE | = | Rear Mount (Chassis Connector) |
| | CM | = | Mid Mount (Chassis Connector) |
| | CR | = | Chassis Connector Rectangular Metal (Female) |
| | PC | = | Chassis Connector Plastic (Male) |
| Blank | = | Solder Buckets (All styles except PC, CR) | |
| CONTACT TYPE | H | = | Horizontal PCB (Style CC, PC only) |
| | V | = | Vertical PCB (Style CR only) |
| | Blank | = | Nickel Plated Finish |
| SHELL FINISH | B | = | Black Finish |

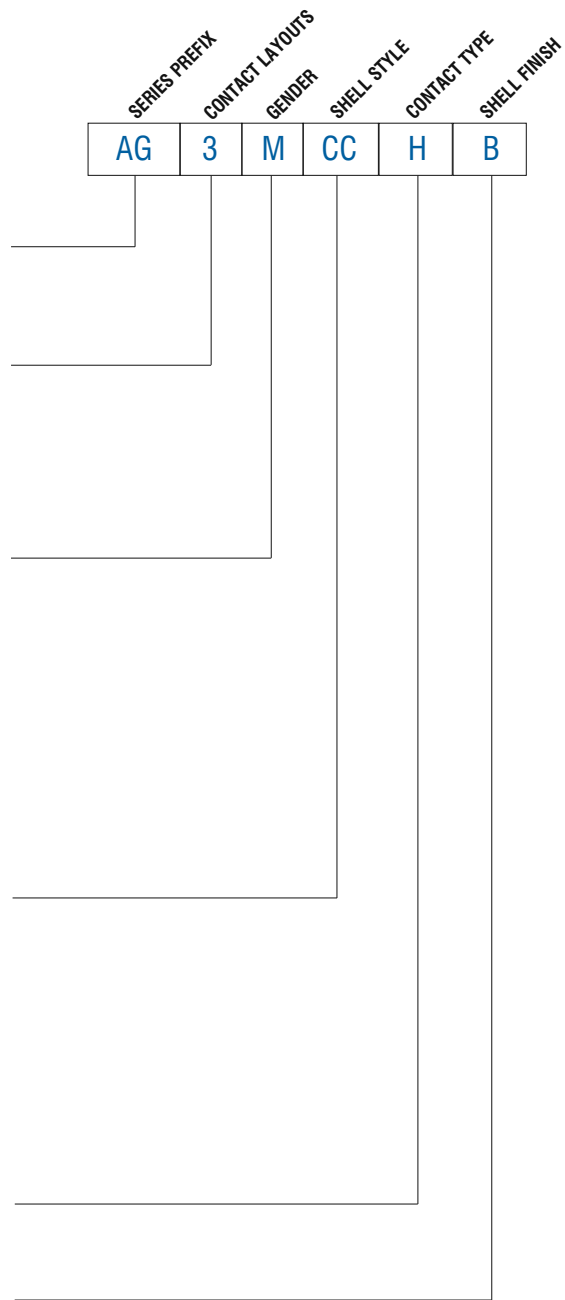

STANDARD DATA G TYPE

| | | VALUE | | | |
|-----------------------------------|---|--|----|-------------------------------|------------------------------|
| GENERAL CHARACTERISTICS | Number of Contacts | 3 | 4 | 5 | 6 |
| | Termination | Printed Circuit Board (PCB) or Solder Bucket | | | |
| | Max. Wire Gauge - Stranded Wire | AWG 24 - 0.5mm ² | | | AWG 28 - 0.38mm ² |
| | Flammability | UL94V-0 | | | |
| | Environmental | Complies with EU RoHS 2 Directive 2011/65/EU | | | |
| ELECTRICAL CHARACTERISTICS | Service Voltage RMS | 1000V | | | 250V |
| | Test Voltage AC RMS | 125V AC | | | |
| | Current Carrying Capacity | 5A | 5A | 4A | 1.2A |
| | Typical Contact Resistance | ≤10mΩ | | | |
| | Insulation resistance (initial) After Damp Heat Test | ≥510MΩ ≥10MΩ | | | |
| | Dielectric Strength | 1500 V dc | | | |
| CLIMATIC CHARACTERISTICS | Protection Class | IP00 | | | |
| | Operating Temperature | -30°C to +80°C (-20F - +176F) | | | |
| MECHANICAL CHARACTERISTICS | Insertion Spring Separating Force | ≥20N | | | |
| | Cable O.D. | 2mm to 3.5mm (0.078" to 0.137") | | 3mm to 5mm (0.118" to 0.196") | |
| | Mechanical Operations | 5000 mating cycles | | | 2000 mating cycles |
| | Weight | 13.5g (0.029lb) | | | |
| MATERIALS | Connector Shell | Bronze & Zinc | | | |
| | Connector Shell Finish | Nickel Plated | | | |
| | Insulators | PPS - Black | | | |
| | Male Contact | Material - Brass C3604 Plating - Gold over Silver Plated | | | |
| | Female Contact | Material - Brass C5210P Plating - Gold over Silver Plated | | | |
| | Latch Lock and Spring | SUS (AISI - 301) - Nickel Plated | | | |
| | Adaptor | PPS - Black | | | |
| | Cable Clamp | Bronze - Nickel Plated | | | |
| | Boot/Backshell | ABS - Black | | | |
| Grommet | PU - Black | | | | |

Rev 4 - 05/2014

¹⁾ Approximate weight only, does not include packaging. Please contact us for exact weight for shipping purposes.



PANEL CUTOUTS - CONNECTOR SIDE OF PCB

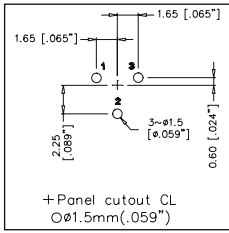

AG3MCC

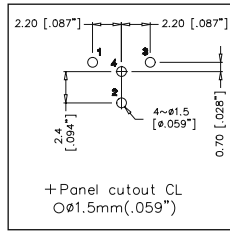

AG4MCC

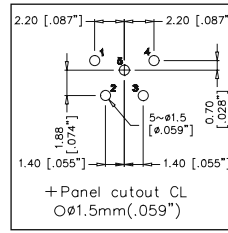

AG5MCC

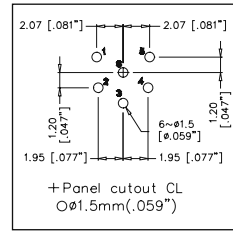

AG6MCC

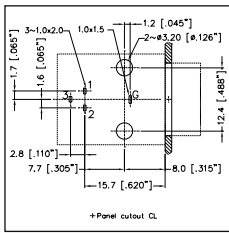

AG3FCCH

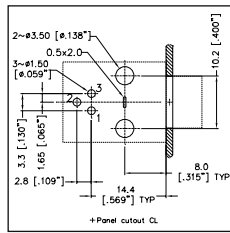

AG3MCCCH

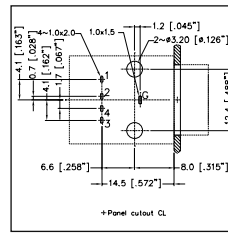

AG4FCCH

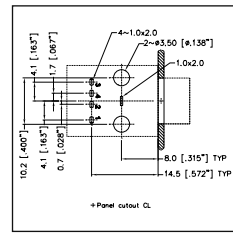

AG4MCCCH

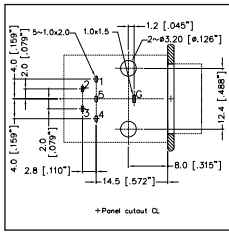

AG5FCCH

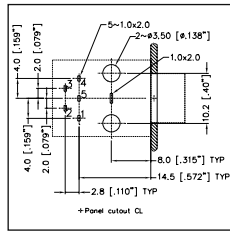

AG5MCCCH

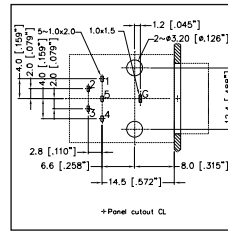

AG6FCCH

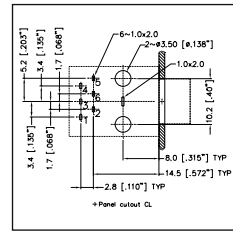

AG6MCCCH

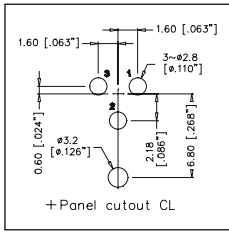

AG3FCRV

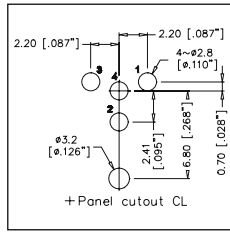

AG4FCRV

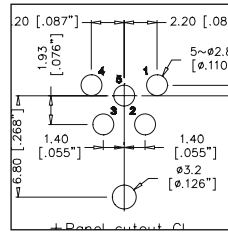

AG5FCRV

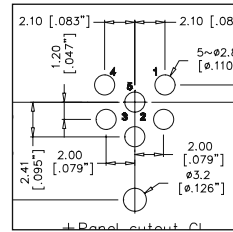

AG6FCRV

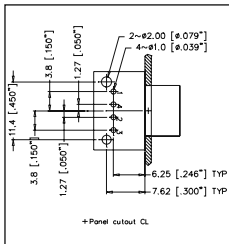

AG4MPCH

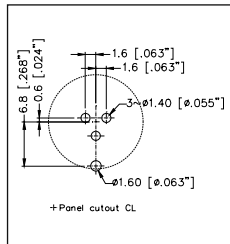

AG3FCE

PANEL CUTOUTS - FRONT VIEW

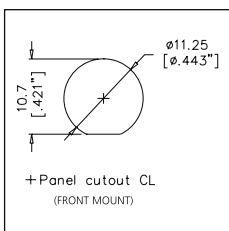

**AG3MCC
AG4MCC
AG5MCC
AG6MCC**

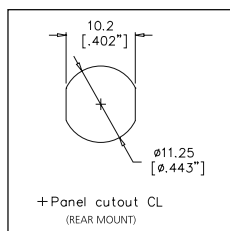

**AG3MCCCH
AG4MCCCH
AG5MCCCH
AG6MCCCH
AG4MPCH**

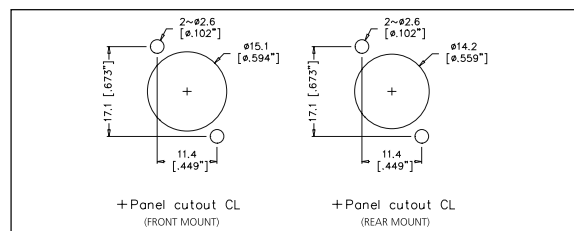

**AG3FCRV
AG4FCRV
AG5FCRV
AG6FCRV**



MULTIPIN CONNECTORS

Amphenol has an extensive range of circular and rectangular multi-pin connectors ideally suited to the entertainment industry. Featuring rugged housings and precision made contacts these connectors have proven themselves in the most demanding of applications. The extensive arrangement of different connector sizes and contact numbers ensure we can offer a solution to your multi-pin wiring applications.

Applications

- Audio Cables and Snakes
- Lighting control
- Concert Touring Systems
- Outside Broadcast Systems

Features / Options - MP-41 Series

- 13 to 85 pins with Crimp / Solder bucket contacts
- 150 pins with Crimp contacts only
- 4 to 48 channel
- Gold plated contacts
- Synthetic inserts
- Environmental resistant
- Positive Bayonet locking
- PG cable gland
- 2000 mating cycles
- Bayonet wear pins
- Extended coupling ring
- Metal Housings

Features / Options - MP-62 Series

- 39 or 61 Solder bucket contacts
- Gold plated contacts
- Neoprene inserts
- Environmental resistant
- Positive Bayonet locking
- PG cable gland or NPT thread
- Metal Housings

Ordering Codes

We have listed the more common ordering codes in each section. For further options please contact us.

Simple steps to guide you in using this catalogue

- 1) Identify the product group listed in Contents on page 1 and go directly to that page number.
- 2) Each product group cover page then details information and options available.
- 3) Refer to the product detail pages and identify the product you require pictorially.
- 4) Read the product description column for the products standard features.
- 5) Use pins column to determine number of contacts.
- 6) Identify part number.
- 7) In the event the particular option you require is not listed please refer to the part number breakdown page at the end of each section.
- 8) Please contact us directly if you have any further problems.

MP-41 SERIES



Amphenol's MP-41 series of multipin connectors utilise the same design principals of the rugged Mil-C-5015 military connectors. They can withstand high shock and vibration environments and are ideal for tough on-road applications. Featuring a quick mating bayonet coupling with an audible full mating feature ensures a positive connection every time. Available from 13 to 150 pins with contacts supplied with each connector as standard.



Features:

- 13 to 85 pins with Crimp/Solder bucket contacts
- 150 pins with Crimp contacts only
- 4 to 48 channels
- Gold plated contacts
- Synthetic insert
- Protective dust caps
- Industry standard compatible
- 2000 mating cycles
- Black finish
- Positive bayonet locking
- PG cable glands
- IP67 rated
- Metal housings

Options: NPT threaded backshells.

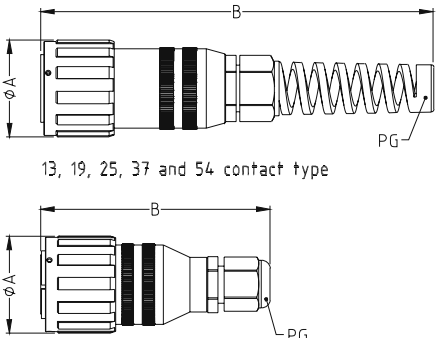
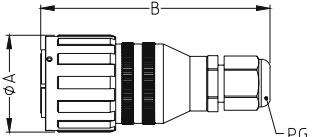

Specifications: Page 127 **Part Number Breakdown:** Page 126 **Wiring Information:** Page 136

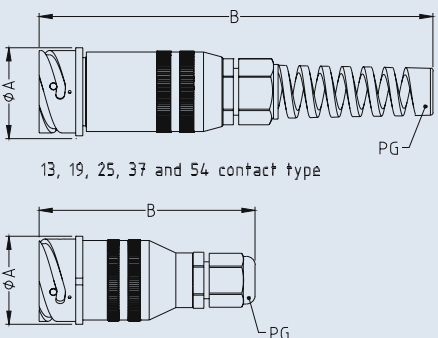
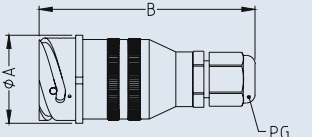

Crimp Tooling: Page 126

| PRODUCT - FIGURE | Dimensions in mm (inches) DRAWING | Dimensions in mm (inches) | | | PINS | PART NUMBER | PART NUMBER With Dustcap |
|--|---|---|---|----------------|---------------|--------------|-----------------------------|
| | | A | B | PG | | | |
|  | <p>Straight cable plug with socket contacts, Black finish, supplied complete with contacts.</p>  <p>13, 19, 25, 37 and 54 contact type</p>  <p>85 and 150 contact type</p> | 40.5 (1.60) | 160 (6.30) | 11 | 13 | MP-4106-13S | MP-4106-13S-C |
| | | 44 (1.73) | 171 (6.73) | 13.5 | 19 | MP-4106-19S | MP-4106-19S-C |
| | | 46.6 (1.83) | 193 (7.60) | 16 | 25 | MP-4106-25S | MP-4106-25S-C |
| | | 54.3 (2.14) | 210 (8.26) | 21 | 37 | MP-4106-37S | MP-4106-37S-C |
| | | 60.1 (2.36) | 210 (8.26) | 21 | 54 | MP-4106-54S | MP-4106-54S-C |
| | | 73.3 (2.88) | 137 (5.40) | 29 | 85 | MP-4106-85S | MP-4106-85S-C |
| | | 73.3 (2.88) | 145 (5.70) | 36 | 150 | MP-4106-150S | MP-4106-150S-C |
| | |  | <p>Cable connecting receptacle with pin contacts, black finish, supplied complete with contacts.</p>  <p>13, 19, 25, 37 and 54 contact type</p>  <p>85 and 150 contact type</p> | 37.8 (1.49) | 160 (6.30) | 11 | 13 |
| 41.1 (1.62) | 171 (6.73) | | | 13.5 | 19 | MP-4101-19P | MP-4101-19P-C |
| 41.5 (1.63) | 193 (7.60) | | | 16 | 25 | MP-4101-25P | MP-4101-25P-C |
| 51 (2.00) | 210 (8.26) | | | 21 | 37 | MP-4101-37P | MP-4101-37P-C |
| 57.1 (2.25) | 210 (8.26) | | | 21 | 54 | MP-4101-54P | MP-4101-54P-C |
| 70 (2.75) | 137 (5.40) | | | 29 | 85 | MP-4101-85P | MP-4101-85P-C |
| 70 (2.75) | 145 (5.70) | | | 36 | 150 | MP-4101-150P | MP-4101-150P-C |

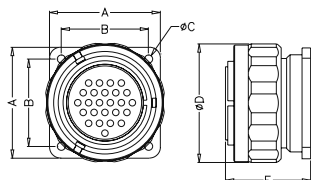
Note: NPT threaded backshells available on request. Please contact us.

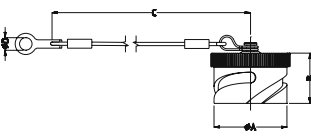

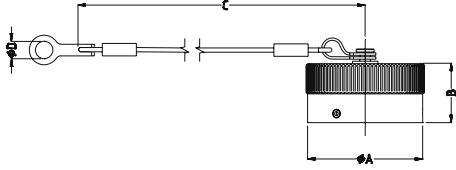
| PRODUCT - FIGURE | Dimensions in mm (inches) DRAWING | Dimensions in mm (inches) | | | | | | PINS | PART NUMBER | PART NUMBER With Dustcap |
|---|--|---------------------------|----------------|----------------|-----------------|----------------|----------------|----------------|---------------|-----------------------------|
| | | A | B | C | D | E | F | | | |
|  | <p>Panel plug with socket contacts, black finish, supplied complete with contacts.</p>  | 38 (1.49) | 29.4 (1.15) | 3.2 (0.13) | 40.5 (1.60) | 38.8 (1.53) | N/A | 13 | MP-4164-13S | MP-4164-13S-C |
| | | 41 (1.61) | 31.8 (1.25) | 3.2 (0.13) | 44 (1.73) | 38.8 (1.53) | N/A | 19 | MP-4164-19S | MP-4164-19S-C |
| | | 44.5 (1.75) | 34.9 (1.37) | 3.73 (0.14) | 48.51 (1.91) | 40.6 (1.60) | N/A | 25 | MP-4164-25S | MP-4164-25S-C |
| | | 50.8 (1.99) | 39.7 (1.56) | 3.73 (0.14) | 54.3 (2.14) | 42 (1.65) | N/A | 37 | MP-4164-37S | MP-4164-37S-C |
| | | 57 (2.24) | 44.5 (1.75) | 4.39 (0.17) | 60.8 (2.40) | 45 (1.77) | N/A | 54 | MP-4164-54S | MP-4164-54S-C |
| | | 69.8 (2.74) | 55.5 (2.18) | 4.39 (0.17) | 73.3 (2.88) | 45 (1.77) | N/A | 85 | MP-4164-85S | MP-4164-85S-C |
| | | 69.8 (2.74) | 55.5 (2.18) | 4.39 (0.17) | 73.3 (2.88) | 45 (1.77) | N/A | 150 | MP-4164-150S | MP-4164-150S-C |
| | | 38 (1.49) | 29.4 (1.15) | 3.23 (0.13) | 34.2 (1.34) | 34.5 (1.35) | 29 (1.14) | 13 | MP-4102-13P | MP-4102-13P-C |
| | | 41 (1.61) | 31.8 (1.25) | 3.23 (0.13) | 37.4 (1.47) | 34.5 (1.35) | 32.2 (1.26) | 19 | MP-4102-19P | MP-4102-19P-C |
| | | 44.5 (1.75) | 34.9 (1.37) | 3.73 (0.14) | 40.9 (1.61) | 35.7 (1.40) | 35.3 (1.38) | 25 | MP-4102-25P | MP-4102-25P-C |
| 50.8 (1.99) | 39.7 (1.56) | 3.73 (0.14) | 46.7 (1.83) | 36.5 (1.44) | 41.4 (1.62) | 37 | MP-4102-37P | MP-4102-37P-C | | |
| 57 (2.24) | 44.5 (1.75) | 4.30 (0.17) | 53.4 (2.10) | 38.5 (1.52) | 47.8 (1.88) | 54 | MP-4102-54P | MP-4102-54P-C | | |
| 69.8 (2.74) | 55.5 (2.18) | 4.30 (0.17) | 65.5 (2.57) | 38.5 (1.52) | 59 (2.32) | 85 | MP-4102-85P | MP-4102-85P-C | | |
| 69.8 (2.74) | 55.5 (2.18) | 4.30 (0.17) | 65.5 (2.57) | 38.5 (1.52) | 59 (2.32) | 150 | MP-4102-150P | MP-4102-150P-C | | |
|  | <p>Plug protective dustcap to suit MP-4164 type.</p>  | 34.16 (1.35) | 31.5 (1.24) | 110 (4.33) | 4.7 (0.18) | - | - | 13 | MP-25042-13S | - |
| | | 37.36 (1.47) | 31.5 (1.24) | 110 (4.33) | 4.7 (0.18) | - | - | 19 | MP-25042-19S | - |
| | | 40.87 (1.61) | 31.5 (1.24) | 110 (4.33) | 4.7 (0.18) | - | - | 25 | MP-25042-25S | - |
| | | 46.68 (1.84) | 31.5 (1.24) | 110 (4.33) | 4.7 (0.18) | - | - | 37 | MP-25042-37S | - |
| | | 53.36 (2.10) | 31.5 (1.24) | 110 (4.33) | 5.5 (0.22) | - | - | 54 | MP-25042-54S | - |
| | | 65.48 (2.58) | 31.5 (1.24) | 110 (4.33) | 5.5 (0.22) | - | - | 85 | MP-25042-85S | - |
| | | 65.48 (2.58) | 31.5 (1.24) | 110 (4.33) | 5.5 (0.22) | - | - | 150 | MP-25042-150S | - |
| | | 38.8 (1.53) | 20.7 (0.81) | 255 (8.07) | - | - | - | 13 | MP-25042-13L | - |
| 41.6 (1.64) | 20.7 (0.81) | 255 (8.07) | - | - | - | 19 | MP-25042-19L | - | | |
| 45.3 (1.78) | 20.7 (0.81) | 255 (8.07) | - | - | - | 25 | MP-25042-25L | - | | |
| 52.15 (2.05) | 20.7 (0.81) | 255 (8.07) | - | - | - | 37 | MP-25042-37L | - | | |
| 58.6 (2.30) | 20.7 (0.81) | 255 (8.07) | - | - | - | 54 | MP-25042-54L | - | | |
| 70.7 (2.78) | 20.7 (0.81) | 255 (8.07) | - | - | - | 85 | MP-25042-85L | - | | |
| 70.7 (2.78) | 20.7 (0.81) | 255 (8.07) | - | - | - | 150 | MP-25042-150L | - | | |

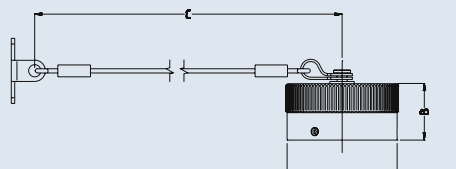
| PRODUCT - FIGURE | Dimensions in mm (inches) DRAWING | Dimensions in mm (inches) | | | | | | PINS | PART NUMBER |
|---|---|--|--|----------------|----------------|---------------|---|------|---------------|
| | | A | B | C | D | E | F | | |
|  | <p>Plug protective dustcap to suit MP-4102 types.</p>  | 34.16 (1.35) | 31.5 (1.24) | 110 (4.33) | 4.7 (0.18) | - | - | 13 | MP-25043-13S |
| | | 37.36 (1.47) | 31.5 (1.24) | 110 (4.33) | 4.7 (0.18) | - | - | 19 | MP-25043-19S |
| | | 40.87 (1.61) | 31.5 (1.24) | 110 (4.33) | 4.7 (0.18) | - | - | 25 | MP-25043-25S |
| | | 46.68 (1.84) | 31.5 (1.24) | 110 (4.33) | 4.7 (0.18) | - | - | 37 | MP-25043-37S |
| | | 53.36 (2.10) | 31.5 (1.24) | 110 (4.33) | 5.5 (0.22) | - | - | 54 | MP-25043-54S |
| | | 65.48 (2.58) | 31.5 (1.24) | 110 (4.33) | 5.5 (0.22) | - | - | 85 | MP-25043-85S |
| | | 65.48 (2.58) | 31.5 (1.24) | 110 (4.33) | 5.5 (0.22) | - | - | 150 | MP-25043-150S |
| | |  | <p>Receptacle protective dustcap to suit MP-4101 types.</p>  | 38.8 (1.53) | 20.7 (0.81) | 255 (8.07) | - | - | - |
| 41.6 (1.64) | 20.7 (0.81) | | | 255 (8.07) | - | - | - | 19 | MP-25043-19L |
| 45.3 (1.78) | 20.7 (0.81) | | | 255 (8.07) | - | - | - | 25 | MP-25043-25L |
| 52.15 (2.05) | 20.7 (0.81) | | | 255 (8.07) | - | - | - | 37 | MP-25043-37L |
| 58.6 (2.30) | 20.7 (0.81) | | | 255 (8.07) | - | - | - | 54 | MP-25043-54L |
| 70.7 (2.78) | 20.7 (0.81) | | | 255 (8.07) | - | - | - | 85 | MP-25043-85L |
| 70.7 (2.78) | 20.7 (0.81) | | | 255 (8.07) | - | - | - | 150 | MP-25043-150L |



| PRODUCT - FIGURE | DRAWING | DESCRIPTION | NO. OF PINS | PART NUMBER |
|---|---------|--|-----------------|--------------|
|  | N/A | Crimp Tool | All | M22520/1-01 |
|  | N/A | Positioner / Turret | All | TH29-1 |
|  | N/A | Insertion tool | 13-85 | MP-INS-16 |
| | | | 150 | MP-INS-18 |
|  | N/A | Extraction tool | All | MP-EXT-16/18 |
|  | N/A | Contact Pilot Pin | 13-85 | MP-GUIDE-16 |
| | | | 150 | MP-GUIDE-18 |
|  | N/A | Solder/Crimp Pin Contact | 13-85 (Size 16) | MP-108400 |
| | | Crimp Pin Contact (Soldering of this contact is not recommended) | 150 (Size 18) | MP-108300 |
|  | N/A | Solder/Crimp Socket Contact | 13-85 (Size 16) | MP-108600 |
| | | Crimp Socket Contact (Soldering of this contact is not recommended) | 150 (Size 18) | MP-108500 |

NOTE: Complete instructions for providing reliable crimped wire to contact terminations and inserting proprietary contacts in MP-41 Series connectors are available in publication PI523 located on our website www.amphenolaudio.com.

PART NUMBER BREAKDOWN MP-41 SERIES

MULTIPIN CIRCULAR CONNECTORS

E. G. **MP-4106-85S**
 Multipin, **4106** Cable Plug, **85** Contacts, **S** Female Socket Contacts,

| | | | |
|---|--------|------------------------------|------------------------------------|
| SERIES PREFIX | MP | = | Series Prefix |
| HOUSING TYPE | 4101 | = | Inline cable connecting receptacle |
| | 4102 | = | Panel receptacle |
| | 4106 | = | Cable plug |
| | 4164 | = | Panel plug |
| | 25042S | = | Dustcap for panel plug |
| | 25042L | = | Dustcap for cable plug |
| | 25043S | = | Dustcap for panel receptacle |
| 25043L | = | Dustcap for cable receptacle | |
| NO. OF CONTACTS | | | 13, 19, 25, 37, 54, 85, 150 |
| GENDER *Not required for dustcap part numbers | P | = | Male pin contacts |
| | S | = | Female socket contacts |
| OPTIONS | C | = | Supplied with Dustcap |

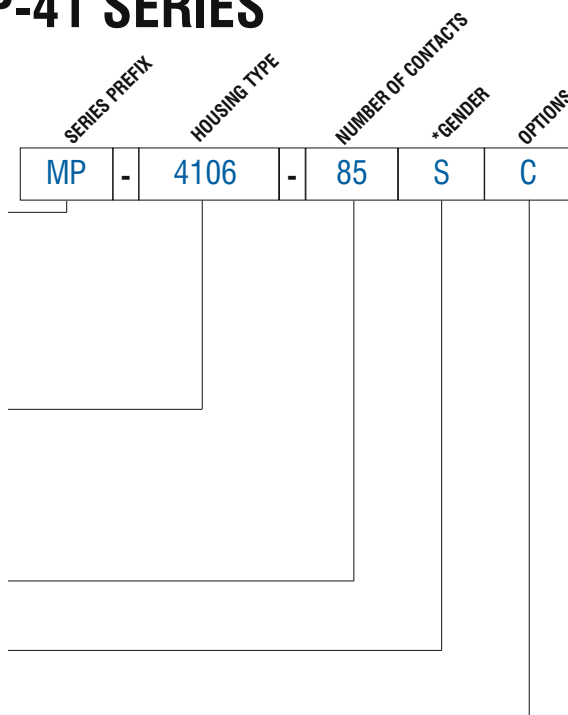

STANDARD DATA MP-41 SERIES

| | | VALUE | | | | | | |
|-----------------------------------|-------------------------------------|--|---------------|---------------|---------------|---------------|---------------|---------|
| GENERAL CHARACTERISTICS | Number of contacts | 13 | 19 | 25 | 37 | 54 | 85 | 150 |
| | Number of channels | 4 | 6 | 8 | 12 | 16 | 28 | 48 |
| | Termination | Solder / Crimp "Combo" | | | | | | Crimp |
| | Wire Gauge - Stranded Wire | 16AWG - 20AWG | | | | | | 18AWG |
| | Environmental | Complies with EU RoHS 2 Directive 2011/65/EU | | | | | | |
| ELECTRICAL CHARACTERISTICS | Operating Voltage at Sea level - DC | 250V* | | | | | | 250V* |
| | Operating Voltage at Sea level - AC | 200V* | | | | | | 200V* |
| | Test Voltage AC RMS | 1000V | | | | | | 1000V |
| | Current Carrying Capacity | 13A | | | | | | 7.5A |
| | Typical Contact Resistance | 3.46mΩ | | | | | | 11.25mΩ |
| | Insulation Resistance | 5000MΩ | | | | | | |
| CLIMATIC CHARACTERISTICS | Protection Class | IP67 (when mated) | | | | | | |
| | Operating Temperature | -55°C to +125°C (-67°F to +257°F) | | | | | | |
| MECHANICAL CHARACTERISTICS | Cable Retention | PG Gland | | | | | | |
| | Mechanical Operations | 2000 mating cycles | | | | | | |
| MATERIALS | Connector / Shell Finish | Aluminium Alloy / Black | | | | | | |
| | Insert | Synthetic Insert to MIL-R-3065 | | | | | | |
| | Male pin contact / Plating | Brass / Gold plated | | | | | | |
| | Female socket contact / Plating | Brass / Gold plated | | | | | | |
| CLAMPING CHARACTERISTICS | PG Gland | 11 | 13.5 | 16 | 21 | 29 | 36 | |
| | Cable Clamping range | mm | 4-10 | 5-12 | 9-14 | 13-18 | 14-25 | 19-32 |
| | (inches) | (0.15"-0.39") | (0.19"-0.47") | (0.35"-0.55") | (0.51"-0.70") | (0.55"-0.98") | (0.74"-1.25") | |

Rev 2 - 03/2013

*Not suitable for domestic applications above 50V











Amphenol's Multipin MP-62 series of circular connectors utilise the same design principles as the Mil-C-26482 military connectors. Featuring a three point quick mating bayonet coupling and five key polarisation ensuring a positive connection every time. Available in two contact pin layouts 39 and 61 with gold plated solder contacts fitted as standard.



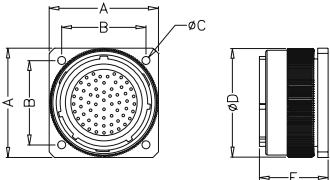

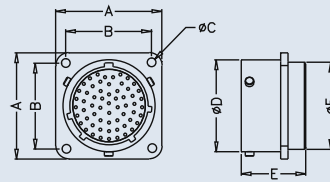

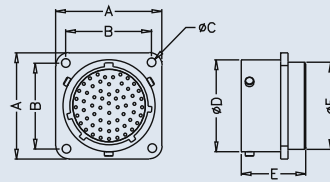

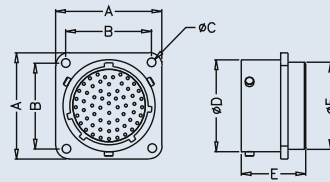

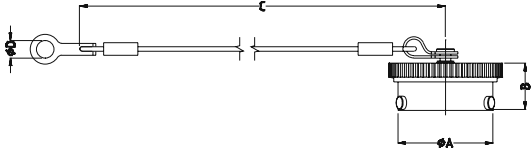

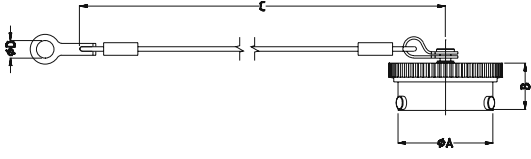

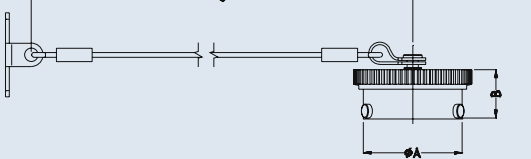
Features:

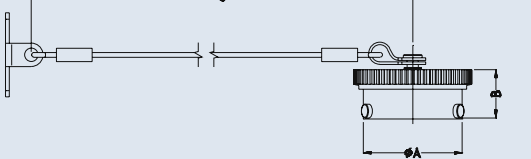
- 39 or 61 pins.
- Gold plated solder contacts.
- Neoprene insert.
- Protective dust caps
- Metal housings
- Environmental resistant.
- Black finish.
- Positive bayonet locking
- PG cable glands

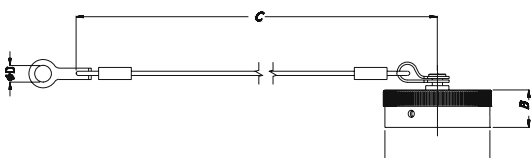
Specifications: Page 130 Wiring Info: Page 135

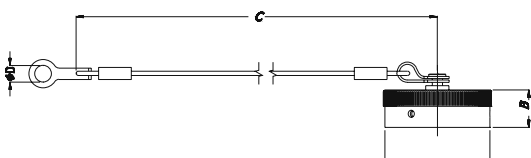
| PRODUCT - FIGURE | Dimensions in mm (inches) DRAWING | Dimensions in mm (inches) | | | PINS | PART NUMBER | PART NUMBER With Dustcap |
|------------------|--|---------------------------|--------|------|------|-------------|-----------------------------|
| | | A | B | PG | | | |
| | <p>Straight cable plug with pin contacts, Black finish, Gold plated solder contacts.</p> | 38.9 | 181.5 | 16 | 39 | MP-6216-39P | MP-6216-39P-C |
| | | (1.53) | (7.15) | | | | |
| | <p>Cable connecting receptacle with socket contacts, Black finish, Gold plated solder contacts.</p> | 45.5 | 193 | 21 | 61 | MP-6216-61P | MP-6216-61P-C |
| | | (1.80) | (7.60) | | | | |
| | <p>Cable connecting receptacle with socket contacts, Black finish, Gold plated solder contacts.</p> | 36.7 | 181.5 | 16 | 39 | MP-6211-39S | MP-6211-39S-C |
| | | (1.45) | (7.15) | | | | |
| | <p>Cable connecting receptacle with socket contacts, Black finish, Gold plated solder contacts.</p> | 43.0 | 193 | 21 | 61 | MP-6211-61S | MP-6211-61S-C |
| | | (1.70) | (7.60) | | | | |
| | <p>Straight cable plug with pin contacts, NPT 3/4" threaded backshell, Black finish, Gold plated solder contacts.</p> | 38.9 | 90 | NPT | 39 | MP-6516-39P | MP-6516-39P-C |
| | | (1.53) | (3.54) | 3/4" | | | |
| | <p>Straight cable plug with pin contacts, NPT 3/4" threaded backshell, Black finish, Gold plated solder contacts.</p> | 45.5 | 100 | NPT | 61 | MP-6516-61P | MP-6516-61P-C |
| | | (1.80) | (3.94) | 3/4" | | | |
| | <p>Cable connecting receptacle with socket contacts, NPT 3/4" threaded backshell, Black finish, Gold plated solder contacts.</p> | 36.7 | 90 | NPT | 39 | MP-6511-39S | MP-6511-39S-C |
| | | (1.45) | (3.54) | 3/4" | | | |
| | <p>Cable connecting receptacle with socket contacts, NPT 3/4" threaded backshell, Black finish, Gold plated solder contacts.</p> | 43.0 | 100 | NPT | 61 | MP-6511-61S | MP-6511-61S-C |
| | | (1.70) | (3.94) | 3/4" | | | |

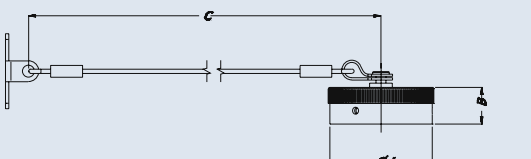
| PRODUCT - FIGURE | Dimensions in mm (inches) DRAWING | Dimensions in mm (inches) | | | | | | PINS | PART NUMBER | PART NUMBER With Dustcap |
|---|---|---------------------------|--------|--------|--------|--------|--------|------|-------------|-----------------------------|
| | | A | B | C | D | E | F | | | |
|  | Panel plug with pin contacts, Black finish, Gold plated solder contacts.  | 38.86 | 29.36 | 6-32 | 39.0 | 32 | - | 39 | MP-6256-39P | MP-6256-39P-C |
| | | (1.53) | (1.16) | UNC | (1.54) | (1.26) | - | | | |
|  | Panel receptacle plug with socket contacts, Black finish, Gold plated solder contacts.  | 43.94 | 34.93 | 6-32 | 45.5 | 35 | - | 61 | MP-6256-61P | MP-6256-61P-C |
| | | (1.73) | (1.38) | UNC | (1.80) | (1.38) | - | | | |
|  | Panel receptacle plug with socket contacts, Black finish, Gold plated solder contacts.  | 36.7 | 29.36 | 3.05 | 31.8 | 22.3 | 30.1 | 39 | MP-6212-39S | MP-6212-39S-C |
| | | (1.44) | (1.15) | (0.12) | (1.25) | (0.87) | (1.18) | | | |
|  | Panel receptacle plug with socket contacts, Black finish, Gold plated solder contacts.  | 43.0 | 34.93 | 3.74 | 38.1 | 22.3 | 36.4 | 61 | MP-6212-61S | MP-6212-61S-C |
| | | (1.69) | (1.38) | (0.15) | (1.50) | (0.87) | (1.43) | | | |

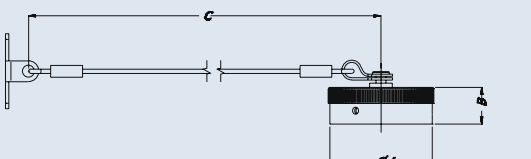
| PRODUCT - FIGURE | DRAWING Dimensions in mm (inches) | DESCRIPTION | Dimensions in mm (inches) | | | | PINS | PART NUMBER |
|---|---|---|---------------------------|--------|--------|--------|------|-------------|
| | | | A | B | C | D | | |
|  |  | Plug protective dustcap to suit MP-6256 | 31.7 | 15.9 | 127 | 4.40 | 39 | MP-742-39S |
| | | | (1.25) | (0.62) | (4.99) | (0.17) | | |
|  |  | Plug protective dustcap to suit MP-6256 | 38.05 | 16.70 | 127 | 4.40 | 61 | MP-742-61S |
| | | | (1.50) | (0.66) | (4.99) | (0.17) | | |
|  |  | Receptacle protective dustcap to suit MP-6216 | 36.9 | 13.13 | 127 | - | 39 | MP-742-39L |
| | | | (1.45) | (0.52) | (4.99) | - | | |
|  |  | Receptacle protective dustcap to suit MP-6216 | 43.14 | 14.15 | 127 | - | 61 | MP-742-61L |
| | | | (1.70) | (0.56) | (4.99) | - | | |
|  |  | Plug protective dustcap to suit MP-6212 | 31.7 | 15.9 | 127 | 4.40 | 39 | MP-738-39S |
| | | | (1.25) | (0.62) | (4.99) | (0.17) | | |
|  |  | Plug protective dustcap to suit MP-6212 | 38.05 | 16.70 | 127 | 4.40 | 61 | MP-738-61S |
| | | | (1.50) | (0.66) | (4.99) | (0.17) | | |
|  |  | Receptacle protective dustcap to suit MP-6211 | 36.9 | 13.13 | 127 | - | 39 | MP-738-39L |
| | | | (1.45) | (0.52) | (4.99) | - | | |
|  |  | Receptacle protective dustcap to suit MP-6211 | 43.14 | 14.15 | 127 | - | 61 | MP-738-61L |
| | | | (1.70) | (0.56) | (4.99) | - | | |



STANDARD DATA MP-62 SERIES / MP - 65 SERIES

| | | VALUE | |
|-----------------------------------|--|--|---------------------|
| GENERAL CHARACTERISTICS | Number of contacts | 39 | 61 |
| | Number of channels | 12 | 20 |
| | Termination | Solder | |
| | Wire Gauge - Stranded Wire | 37 x 24AWG-20AWG 2 x 20AWG-16AWG | 24AWG-20AWG |
| | Environmental | Complies with EU RoHS 2 Directive 2011/65/EU | |
| ELECTRICAL CHARACTERISTICS | Operating Voltage at Sea level - DC | 600V* | |
| | Operating Voltage at Sea level - AC | 600V* | |
| | Test Voltage AC RMS | 1500V | |
| | Current Carrying Capacity | 37 x 7.5A 2 x 13A | 7.5A |
| | Insulation Resistance | 5000MΩ | |
| CLIMATIC CHARACTERISTICS | Protection Class | IP67 (when mated) | |
| | Operating Temperature | -55°C to +125°C (-67°F to +257°F) | |
| MECHANICAL CHARACTERISTICS | Cable Retention | PG Gland / NPT Thread | |
| | Mechanical Operations | 500 mating cycles (minimum) | |
| MATERIALS | Connector / Shell Finish | Aluminium Alloy / Black | |
| | Insert | Neoprene | |
| | Male pin contact machined - Plating | Brass / Gold plated | |
| | Female socket contact machined - Plating | Brass / Gold plated | |
| CLAMPING CHARACTERISTICS | PG Gland | 16 | 21 |
| | Cable Clamping range mm (inches) | 9-14 (0.35"-0.55") | 13-18 (0.51"-0.70") |

*Not suitable for domestic applications above 50V

Rev 3 - 03/2013





146 SERIES RECTANGULAR CONNECTORS

Amphenol Tuchel C146 series rectangular connectors feature modular components ensuring a vast range of different features and benefits for the end user. The zinc diecast aluminum housings are finished in a durable powder coat and available in either top or side entry. Connector coupling is achieved via a positive locking lever ensuring a positive rapid connection. The C146 series is suitable for general-purpose audio and lighting applications and is completely intermateable with all competitor connectors.



FIBRE OPTIC

Amphenol has over 25 years experience in fibre optics dating back to their development of the first industry standard connector, the SMA. Today we can offer a complete range of products including Hybrid Fibre optic connectors for HDTV broadcast cameras SMPTE 304M compliant and ruggedised connectors and cable assemblies for indoor or outdoor applications.



Amphenol

AC SERIES

ACCESSORIES



ACCESSORIES

- Colour coded boots(backshells) and rings to assist in cable identification.
- In-line adaptors. Pre-wired for convenience.
- Termination tool for fast assembly of cable connectors.
- Mounting hardware.
- Metal boots(backshells) for rugged environments.











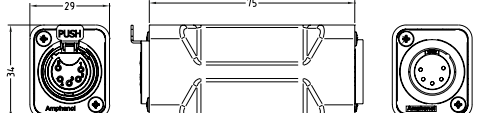

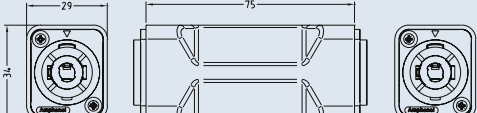

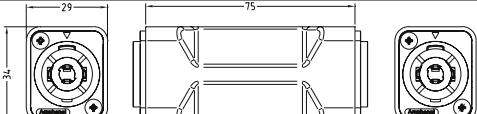

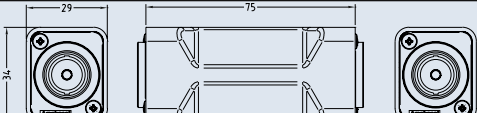

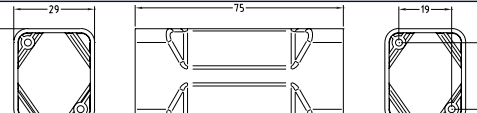

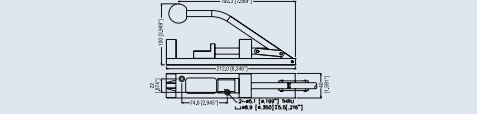
| PRODUCT - FIGURE | DRAWING | Dimensions in mm (inches) | DESCRIPTION | VARIATIONS | PART NUMBER |
|------------------|---------|--|---|-------------------------------|----------------------|
| | | 60.4 [2.378"] ø19.0 [ø.748"] | XLR 3 pole male to 3 pole male adapter, Pre wired, Metal Shell | Nickel Finish Black Finish | AC3M3MW AC3M3MBW |
| | | 60.4 [2.378"] 66.5 [2.616"] ø19.0 [ø.748"] | XLR 3 pole female to 3 pole female adapter, Pre wired, Metal Shell | Nickel Finish Black Finish | AC3F3FW AC3F3FBW |
| | | 60.4 [2.378"] 73.5 [2.892"] ø19.0 [ø.748"] | XLR 3 pole female to 3 pole male adapter, Pre wired, Metal Shell | Nickel Finish Black Finish | AC3F3FBW AC3F3MBW |
| | | 62.5 [2.461"] 75.7 [2.980"] ø18.9 [ø.744"] | XLR 3 pole female to 5 pole male adapter, Pre wired, Metal Shell | Nickel Finish | AC3F5MW |
| | | 62.5 [2.461"] 75.7 [2.980"] ø18.9 [ø.744"] | XLR 3 pole male to 5 pole female adapter, Pre wired, Metal Shell | Nickel Finish | AC3M5FW |
| | | 76 [2.991"] ø19 [ø.748"] | XLR 5 pole male to 5 pole male adapter, Pre wired, Metal Shell | Nickel Finish | AC5M5MW |
| | | 29 34 75 | XLR D shell adapter, 3 pole male to 3 pole male, Pre-wired | Not Applicable | AC3M3MDW |
| | | 29 34 75 | XLR D shell adapter, 3 pole female to 3 pole female, Pre-wired | Not Applicable | AC3F3FDW |
| | | 29 34 75 | XLR D shell adapter, 3 pole female to 3 pole male, Pre-wired | Not Applicable | AC3F3MDW |
| | | 29 34 75 | XLR D shell adapter, 5 pole male to 5 pole male, Pre-wired | Not Applicable | AC5M5MDW |
| | | 29 34 75 | XLR D shell adapter, 5 pole female to 5 pole female, Pre-wired | Not Applicable | AC5F5FDW |

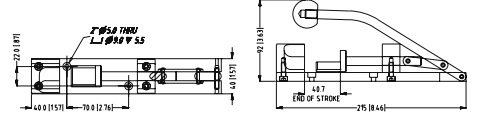
ACC.

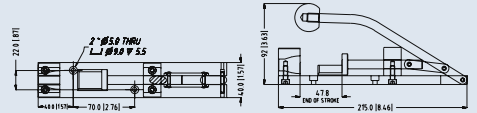

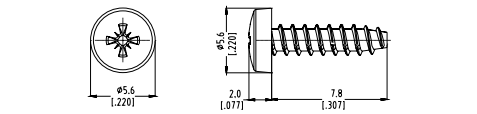

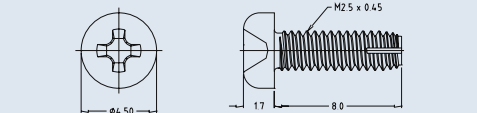

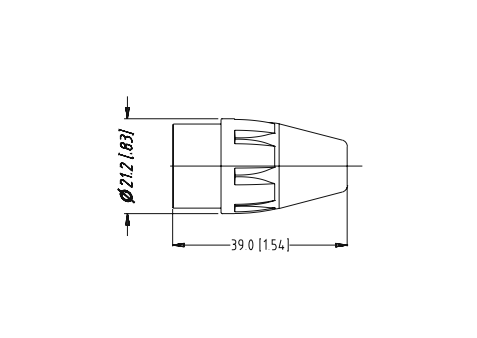

Amphenol

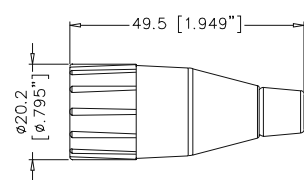
AC SERIES

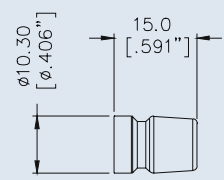
ACCESSORIES

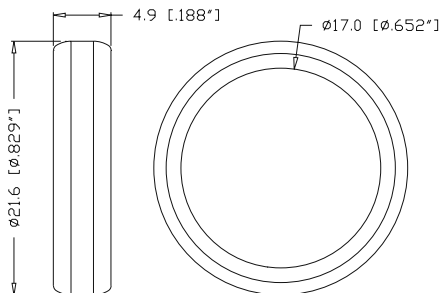
| PRODUCT - FIGURE | DRAWING | Dimensions in mm (inches) | DESCRIPTION | VARIATIONS | PART NUMBER |
|---|---|---------------------------|--|--|--------------|
|  |  | | XLR D shell adapter, 5 pole female to 5 pole male, Pre-wired | Not Applicable | AC5F5MDW |
|  |  | | SP D shell adapter, SP-2 to SP-2, Pre-wired | Not Applicable | SP2F2FDW |
|  |  | | SP D shell adapter, SP-4 to SP-4, Pre-wired | Not Applicable | SP4F4FDW |
|  |  | | BNC D shell adapter, Jack to Jack, Pre-wired | Not Applicable | ACBNCJJDW |
|  |  | | D shell adapter without connectors | Not Applicable | AC-D-ADAPTER |
|  |  | | Termination Tool | For IDC and Solder cable connectors | T2860 |
|  |  | | Termination Tool | For AC Series Right Angle cable connectors | T2880 |
|  |  | | Termination Tool | For AX Series cable connectors | T2890 |
|  |  | | A Type / C Type Connector Mounting, Self-Tapping Screw | 2.9 x 1.06 Tri-rondular | 52500014-734 |
|  |  | | B Type / XLRnet Connector Mounting, Self-Tapping Screw | M2.5 | 52500005-732 |
|  |  | | AX Series Coloured Boot | Brown | AX-BOOT-1 |
| | | | | Red | AX-BOOT-2 |
| | | | | Orange | AX-BOOT-3 |
| | | | | Yellow | AX-BOOT-4 |
| | | | | Green | AX-BOOT-5 |
| | | | | Blue | AX-BOOT-6 |
| | | | | Violet | AX-BOOT-7 |
| | | | | Grey | AX-BOOT-8 |
| | | | | White | AX-BOOT-9 |
| | | | | Black | AX-BOOT |
| Clear | AX-BOOT-CLR | | | | |

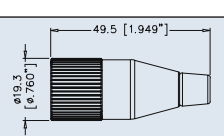
ACC.

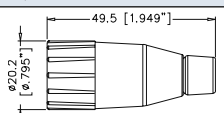
| PRODUCT - FIGURE | DRAWING Dimensions in mm (inches) | DESCRIPTION | VARIATIONS | PART NUMBER |
|---|---|--|----------------|-----------------|
|  |  <p>49.5 [1.949"] ø20.2 [ø.795"]</p> | AC Coloured Boot / Backshell Note: Number Identification optional. (Please contact us.) | Brown | AC-NUT-BRN |
| | | | Red | AC-NUT-RED |
| | | | Orange | AC-NUT-ORG |
| | | | Yellow | AC-NUT-YEL |
| | | | Green | AC-NUT-GRN |
| | | | Blue | AC-NUT-BLU |
| | | | Violet | AC-NUT-VIO |
| | | | Grey | AC-NUT-GRY |
| | | | White | AC-NUT-WHT |
|  |  <p>ø10.30 [ø.406"] 15.0 [.591"]</p> | Coloured Grommets to suit AC Series, T Series and Musician range | Brown | AC-GROMMET-BRN |
| | | | Red | AC-GROMMET-RED |
| | | | Orange | AC-GROMMET-ORG |
| | | | Yellow | AC-GROMMET-YEL |
| | | | Green | AC-GROMMET-GRN |
| | | | Blue | AC-GROMMET-GRN |
| | | | Violet | AC-GROMMET-VIO |
| | | | Grey | AC-GROMMET-GRY |
| | | | White | AC-GROMMET-WHT |
|  |  <p>4.9 [188"] ø21.6 [ø.829"] ø17.0 [ø.652"]</p> | AC Coloured Identification Rings – Plain and Numbered Note: Custom number Identification optional. (Please contact us.) | Brown | AC-RING-BRN |
| | | | Red | AC-RING-RED |
| | | | Orange | AC-RING-ORG |
| | | | Yellow | AC-RING-YEL |
| | | | Green | AC-RING-GRN |
| | | | Blue | AC-RING-BLU |
| | | | Violet | AC-RING-VIO |
| | | | Grey | AC-RING-GRY |
| | | | White | AC-RING-WHT |
| | | | Red #1-24 | AC-RING-RED-PK1 |
| | | | Yellow #1-24 | AC-RING-YEL-PK1 |
| | | | Blue #1-24 | AC-RING-BLU-PK1 |
| | | | Red #1-48 | AC-RING-RED-PK2 |
| Yellow #1-48 | AC-RING-YEL-PK2 | | | |
| Blue #1-48 | AC-RING-BLU-PK2 | | | |
|  |  <p>49.5 [1.949"] ø19.3 [ø.760"]</p> | AC Metal Boot / Backshell, Black Finish | Not Applicable | AC-NUT-METAL |
|  |  <p>49.5 [1.949"] ø20.2 [ø.795"]</p> | AC Thermoplastic Boot / Backshell. Suitable for use with 8.5mm (0.33") O.D. cable. | Not Applicable | AC-NUT-J-BLK |

ACC.

NOTE: All accessories comply with EU RoHS 2 Directive 2011/65/EU
 NOTE: Please do not refer to this printed catalogue as a colour reference. For exact colours contact your sales representative.

CONNECTOR WIRING INFORMATION

XLR (Microphone / Patch Cables)

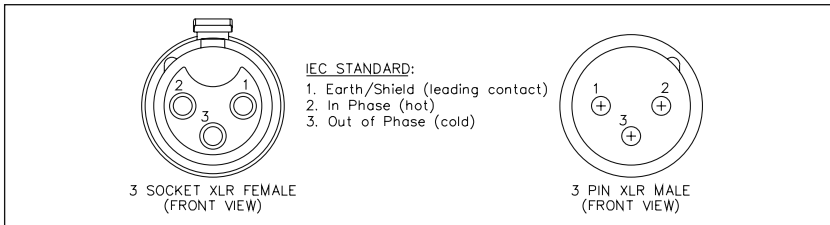

The standard XLR 3 contact pin outs are as shown above for a balanced lead. In such a configuration audio "Hot" (pin 2) is the in-phase connection whilst audio "Cold" (pin 3) is the out-of-phase connection. For an unbalanced lead however, you may connect pin 1 to either pin 2 or pin 3, but not both. In such a configuration the remaining pin is used for the audio signal.

When terminating the cable shielding to pin 1 it is suggested that the shield be only grounded at one end of the cable to avoid inducing "hum". Pin 1 is a leading contact that engages at interconnection, before pin 2 or pin 3.

1/4" Phono (6.35mm) (Standard Applications)

MICROPHONE CABLE - BALANCED

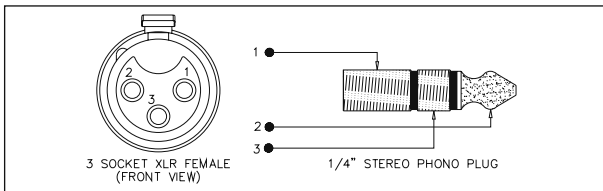

MICROPHONE CABLE - UNBALANCED

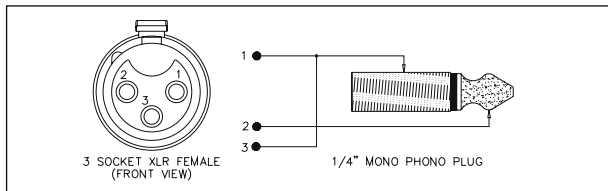

INSTRUMENT / LINE CABLE (MONO)

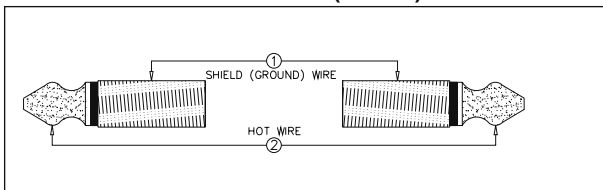

INSTRUMENT / LINE CABLE (STEREO)

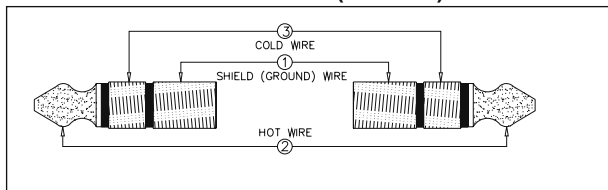

CONNECTOR WIRING INFORMATION

MP Series

MP-41 Series
4 Ch - 13 pin

| Ch | + | - | G |
|---------|---|---|---|
| 1 | B | C | E |
| 2 | F | K | H |
| 3 | J | D | A |
| 4 | N | M | G |
| General | | | |
| Ground | L | | |

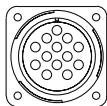

MP-41 Series
6 Ch - 19 pin

| Ch | + | - | G |
|---------|---|---|---|
| 1 | L | M | U |
| 2 | A | N | B |
| 3 | K | J | T |
| 4 | V | P | C |
| 5 | H | S | G |
| 6 | R | D | E |
| General | | | |
| Ground | F | | |

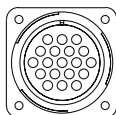

MP-41 Series
8 Ch - 25 pin

| Ch | + | - | G |
|---------|---|---|---|
| 1 | A | E | F |
| 2 | G | C | B |
| 3 | D | H | J |
| 4 | M | L | K |
| 5 | Q | P | N |
| 6 | W | S | R |
| 7 | T | X | Y |
| 8 | Z | V | U |
| General | | | |
| Ground | a | | |

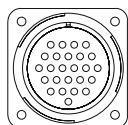

MP-41 Series
12 Ch - 37 pin

| Ch | + | - | G |
|---------|---|---|---|
| 1 | E | F | A |
| 2 | B | C | G |
| 3 | H | J | D |
| 4 | S | T | K |
| 5 | L | M | U |
| 6 | V | W | N |
| 7 | P | R | X |
| 8 | a | b | g |
| 9 | c | d | j |
| 10 | e | f | m |
| 11 | n | p | h |
| 12 | r | s | k |
| General | | | |
| Ground | z | | |

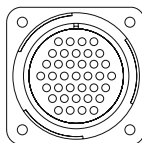

MP-41 Series
16 Ch - 54 pin

| Ch | + | - | G |
|---------|----|---|----|
| 1 | W | f | r |
| 2 | J | R | a |
| 3 | k | v | AC |
| 4 | E | M | V |
| 5 | e | q | y |
| 6 | B | H | P |
| 7 | Z | j | u |
| 8 | D | L | U |
| 9 | d | p | x |
| 10 | A | G | O |
| 11 | Y | h | t |
| 12 | C | K | T |
| 13 | c | n | w |
| 14 | F | N | X |
| 15 | g | s | AB |
| 16 | S | b | m |
| General | | | |
| Ground | AG | | |

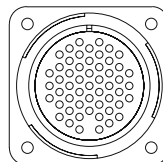

MP-41 Series
28 Ch - 85 pin

| Ch | + | - | G |
|---------|----|----|----|
| 1 | A | B | C |
| 2 | E | F | H |
| 3 | J | K | L |
| 4 | N | P | R |
| 5 | S | T | U |
| 6 | X | Y | Z |
| 7 | a | b | c |
| 8 | d | f | g |
| 9 | h | i | j |
| 10 | k | m | n |
| 11 | p | q | r |
| 12 | t | u | v |
| 13 | w | x | y |
| 14 | z | AA | AB |
| 15 | AC | AD | AE |
| 16 | AF | AH | AJ |
| 17 | AK | AL | AM |
| 18 | AP | AR | AS |
| 19 | AT | AU | AV |
| 20 | AW | AX | AY |
| 21 | AZ | BA | BB |
| 22 | BC | BD | BE |
| 23 | BJ | BK | BL |
| 24 | BM | BN | BP |
| 25 | BS | BT | BU |
| 26 | BV | BR | BF |
| 27 | BH | AN | s |
| 28 | W | M | D |
| General | | | |
| Ground | V | | |

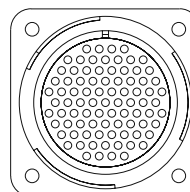

MP-41 Series
48 Ch - 150 pin

| Ch | + | - | G |
|---------|-----|-----|-----|
| 1 | 1 | 2 | 3 |
| 2 | 5 | 6 | 7 |
| 3 | 8 | 9 | 10 |
| 4 | 11 | 12 | 13 |
| 5 | 14 | 15 | 16 |
| 6 | 17 | 18 | 19 |
| 7 | 21 | 22 | 23 |
| 8 | 24 | 25 | 26 |
| 9 | 27 | 28 | 29 |
| 10 | 20 | 30 | 31 |
| 11 | 32 | 33 | 34 |
| 12 | 35 | 36 | 37 |
| 13 | 38 | 39 | 40 |
| 14 | 41 | 42 | 43 |
| 15 | 44 | 45 | 46 |
| 16 | 47 | 48 | 49 |
| 17 | 50 | 51 | 52 |
| 18 | 53 | 54 | 55 |
| 19 | 57 | 58 | 59 |
| 20 | 60 | 61 | 62 |
| 21 | 63 | 64 | 65 |
| 22 | 66 | 67 | 68 |
| 23 | 69 | 70 | 71 |
| 24 | 72 | 73 | 74 |
| 25 | 75 | 76 | 77 |
| 26 | 78 | 79 | 80 |
| 27 | 82 | 83 | 84 |
| 28 | 85 | 86 | 87 |
| 29 | 88 | 89 | 90 |
| 30 | 91 | 92 | 93 |
| 31 | 94 | 95 | 96 |
| 32 | 97 | 98 | 99 |
| 33 | 100 | 101 | 102 |
| 34 | 103 | 104 | 105 |
| 35 | 56 | 81 | 106 |
| 36 | 107 | 108 | 109 |
| 37 | 110 | 111 | 112 |
| 38 | 113 | 114 | 115 |
| 39 | 116 | 117 | 118 |
| 40 | 119 | 120 | 121 |
| 41 | 122 | 123 | 124 |
| 42 | 125 | 126 | 127 |
| 43 | 139 | 128 | 129 |
| 44 | 130 | 131 | 132 |
| 45 | 133 | 134 | 135 |
| 46 | 136 | 137 | 138 |
| 47 | 140 | 141 | 142 |
| 48 | 143 | 144 | 145 |
| General | | | |
| Ground | 150 | | |

MP-62 Series
12 Ch - 39 pin

| Ch | + | - | G |
|---------|-----|---|---|
| 1 | p | n | q |
| 2 | W | A | X |
| 3 | N | f | P |
| 4 | L | e | M |
| 5 | J | d | K |
| 6 | G | c | H |
| 7 | E | b | F |
| 8 | D | a | Z |
| 9 | C | B | Y |
| 10 | U | j | V |
| 11 | i | h | T |
| 12 | R | g | S |
| General | | | |
| Ground | N/A | | |

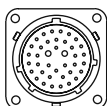

MP-62 Series
20 Ch - 61 pin

| Ch | + | - | G |
|---------|-----|----|----|
| 1 | JJ | HH | NN |
| 2 | MM | KK | PP |
| 3 | BB | AA | CC |
| 4 | s | FF | W |
| 5 | r | EE | V |
| 6 | e | D | x |
| 7 | f | E | y |
| 8 | q | DD | U |
| 9 | S | p | T |
| 10 | P | N | R |
| 11 | m | k | n |
| 12 | L | K | M |
| 13 | J | i | j |
| 14 | H | G | h |
| 15 | g | F | z |
| 16 | d | C | w |
| 17 | B | A | c |
| 18 | b | a | Z |
| 19 | v | u | Y |
| 20 | t | GG | X |
| General | | | |
| Ground | N/A | | |

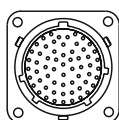

| | | | | | | | | |
|-----------------|----------------|-----|--------------|-----|---------------|----|-----------------|-----|
| Symbols | AC3FDZB-AU | 19 | AC4FB BULK | 12 | AC5MPB | 23 | AC-BNC20BP75 | 84 |
| 47-10070 | AC3FDZB BULK | 19 | AC4FBJ | 12 | AC5MPNZ | 23 | AC-BNC20M | 84 |
| 47-10090 | AC3FDZ BULK | 19 | AC4F BULK | 12 | AC5MPNZB | 23 | AC-BNC20MJ75 | 84 |
| 47-10110 | AC3FJ | 11 | AC4FDZ | 20 | AC6AF | 13 | AC-BNC20MP75 | 84 |
| 47-10120 | AC3FPZ | 22 | AC4FDZ-AU | 20 | AC6AF-AU | 13 | AC-BNC40A | 84 |
| 47-10150 | AC3FPZB | 22 | AC4FDZB | 20 | AC6AFB | 13 | AC-BNC40AJ75 | 84 |
| 112119 | AC3M | 11 | AC4FDZB-AU | 20 | AC6AFB-AU | 13 | AC-BNC40AP75 | 84 |
| 112133 | AC3M3MBW | 132 | AC4FDZB BULK | 20 | AC6AFB BULK | 13 | AC-BNC40B | 84 |
| 112133 | AC3M3MDW | 132 | AC4FDZ BULK | 20 | AC6AFBJ | 13 | AC-BNC40BJ75 | 84 |
| 112507 | AC3M3MW | 132 | AC4FDZV | 20 | AC6AF BULK | 13 | AC-BNC40BP75 | 84 |
| 112508 | AC3M5FW | 132 | AC4FDZVB | 20 | AC6AFDZ | 21 | AC-BNC40M | 84 |
| 112509 | AC3MA-AU-PRE | 30 | AC4FJ | 12 | AC6AFDZ-AU | 21 | AC-BNC40MJ75 | 84 |
| 112519 | AC3MAH1-AU-PRE | 29 | AC4FPZ | 23 | AC6AFDZB | 21 | AC-BNC40MP75 | 84 |
| 112521 | AC3MAH2-AU-PRE | 29 | AC4FPZB | 23 | AC6AFDZB-AU | 21 | AC-BNC-JJ-75 | 83 |
| 112565 | AC3MAH4-SW-B | 29 | AC4M | 12 | AC6AFDZB BULK | 21 | AC-BNC-JJ-75B | 83 |
| 112606 | AC3MAH-AU-PRE | 29 | AC4M-AU | 12 | AC6AFDZ BULK | 21 | AC-BNC-JJA-75T | 83 |
| 112950 | AC3M-AU | 11 | AC4MB | 12 | AC6AFDZV | 21 | ACBNCJJDW | 133 |
| 112951 | AC3MAV2-AU-PRE | 30 | AC4MB-AU | 12 | AC6AFDZVB | 21 | AC-BNC-JS-75 | 83 |
| 112952 | AC3MAV-AU-PRE | 29 | AC4MB BULK | 12 | AC6AFJ | 13 | AC-BNC-JS-75B | 83 |
| 112953 | AC3MB | 11 | AC4MBJ | 12 | AC6AFPZ | 23 | AC-BNC-LABEL | 84 |
| 112955 | AC3MB-AU | 11 | AC4M BULK | 12 | AC6AFPZB | 23 | AC-BNC-PJ-75 | 83 |
| 112956 | AC3MB BULK | 11 | AC4MDZ | 20 | AC6AM | 13 | AC-BNC-PJ-75B | 83 |
| 112957 | AC3MBH1-AU-B | 32 | AC4MDZ-AU | 20 | AC6AM-AU | 13 | AC-BNC-PJA-75T | 83 |
| 52500002-734 | AC3MBH2-AU-B | 32 | AC4MDZB | 20 | AC6AMB | 13 | AC-D-ADAPTER | 133 |
| 52500005-732 | AC3MBH3-AU-B | 32 | AC4MDZB-AU | 20 | AC6AMB-AU | 13 | AC-GROMMET-BRN | 134 |
| | AC3MBH-AU-B | 32 | AC4MDZB BULK | 20 | AC6AMB BULK | 13 | AC-GROMMET-GRN | 134 |
| A | AC3MBHL-AU-B | 32 | AC4MDZV | 20 | AC6AMB BULK | 13 | AC-GROMMET-GRY | 134 |
| | AC3MBJ | 11 | AC4MDZVB | 20 | AC6AMBJ | 13 | AC-GROMMET-ORG | 134 |
| AC3F | AC3M BULK | 11 | AC4MJ | 12 | AC6AMDZ | 21 | AC-GROMMET-RED | 134 |
| AC3F3FBW | AC3MBV1-AU-B | 33 | AC4MP | 23 | AC6AMDZ-AU | 21 | AC-GROMMET-VIO | 134 |
| AC3F3FDW | AC3MBV2-AU-B | 33 | AC4MPB | 23 | AC6AMDZB | 21 | AC-GROMMET-WHT | 134 |
| AC3F3FW | AC3MBV3-AU-B | 33 | AC4MPNZ | 22 | AC6AMDZB-AU | 21 | AC-GROMMET-YEL | 134 |
| AC3F3MBW | AC3MBV-AU-B | 32 | AC4MPNZB | 22 | AC6AMDZB BULK | 21 | ACJC5H BULK | 46 |
| AC3F3MDW | AC3MCP | 15 | AC5F | 12 | AC6AMDZ BULK | 21 | ACJC5HL BULK | 46 |
| AC3F5MW | AC3MCP-AU | 15 | AC5F5FDW | 132 | AC6AMDZV | 21 | ACJC5S BULK | 46 |
| AC3FAH1-AU-PRE | AC3MCP BULK | 15 | AC5F5MDW | 133 | AC6AMDZVB | 21 | ACJC5SL BULK | 46 |
| AC3FAH2-AU-PRE | AC3MCPJ | 15 | AC5FAH-AU-B | 36 | AC6AMJ | 13 | ACJC5V BULK | 46 |
| AC3FAH-AU-PRE | AC3MDZ | 19 | AC5F-AU | 12 | AC6AMP | 23 | ACJC5VL BULK | 46 |
| AC3FAHL1-AU-PRE | AC3MDZ-AU | 19 | AC5FAV-AU-B | 36 | AC6AMPB | 23 | ACJC6AH BULK | 44 |
| AC3FAHL2-AU-PRE | AC3MDZB | 19 | AC5FB | 12 | AC6AMPNZ | 23 | ACJC6AHL BULK | 44 |
| AC3FAHL-AU-PRE | AC3MDZB-AU | 19 | AC5FB-AU | 12 | AC6AMPNZB | 23 | ACJC6AV2 BULK | 44 |
| AC3F-AU | AC3MDZB BULK | 19 | AC5FB BULK | 12 | AC7F | 13 | ACJC6AV2L BULK | 44 |
| AC3FAV1-AU-PRE | AC3MDZ BULK | 19 | AC5FBJ | 12 | AC7FB | 13 | ACJC6AV BULK | 44 |
| AC3FAV2-AU-PRE | AC3MJ | 11 | AC5F BULK | 12 | AC7FB BULK | 13 | ACJC6AVL BULK | 44 |
| AC3FAV-AU-PRE | AC3MM | 11 | AC5FDZ | 20 | AC7FBJ | 13 | ACJC6H BULK | 47 |
| AC3FAVL1-AU-PRE | AC3MM-AU | 11 | AC5FDZ-AU | 20 | AC7F BULK | 13 | ACJC6HL BULK | 47 |
| AC3FAVL2-AU-PRE | AC3MMB | 11 | AC5FDZB | 20 | AC7FDZ | 21 | ACJC6S BULK | 47 |
| AC3FAVL-AU-PRE | AC3MMB-AU | 11 | AC5FDZB-AU | 20 | AC7FDZB | 21 | ACJC6SL BULK | 47 |
| AC3F-AU | AC3MMB BULK | 11 | AC5FDZB BULK | 20 | AC7FDZB BULK | 21 | ACJC6V BULK | 47 |
| AC3FB-AU | AC3MMBJ | 11 | AC5FDZ BULK | 20 | AC7FDZ BULK | 21 | ACJC6VL BULK | 47 |
| AC3FB BULK | AC3MM BULK | 11 | AC5FDZV | 20 | AC7FDZV | 21 | ACJC9AH BULK | 44 |
| AC3FBH1-AU-B | AC3MMCP | 15 | AC5FDZVB | 20 | AC7FDZVB | 21 | ACJC9AHL BULK | 44 |
| AC3FBH2-AU-B | AC3MMCP-AU | 15 | AC5FJ | 12 | AC7FJ | 13 | ACJC9AV2 BULK | 45 |
| AC3FBH3-AU-B | AC3MMCP BULK | 15 | AC5FPZ | 23 | AC7FPZ | 24 | ACJC9AV2L BULK | 45 |
| AC3FBH-AU-B | AC3MMCPJ | 15 | AC5FPZB | 23 | AC7FPZB | 24 | ACJC9AVL BULK | 45 |
| AC3FBHL1-AU-B | AC3MMDZ | 19 | AC5M | 12 | AC7M | 13 | ACJC9H BULK | 47 |
| AC3FBHL2-AU-B | AC3MMDZ-AU | 19 | AC5M5MDW | 132 | AC7MB | 13 | ACJC9HL BULK | 47 |
| AC3FBHL3-AU-B | AC3MMDZB | 19 | AC5M5MW | 132 | AC7MB BULK | 13 | ACJC9S BULK | 48 |
| AC3FBHL-AU-B | AC3MMDZB-AU | 19 | AC5MAH-AU-B | 36 | AC7MBJ | 13 | ACJC9SL BULK | 48 |
| AC3FBJ | AC3MMDZB BULK | 19 | AC5M-AU | 12 | AC7M BULK | 13 | ACJC9V BULK | 48 |
| AC3F BULK | AC3MMDZ BULK | 19 | AC5MAV-AU-B | 36 | AC7MDZ | 21 | ACJC9VL BULK | 48 |
| AC3FBV1-AU-B | AC3MMDZV | 19 | AC5MB | 12 | AC7MDZB | 21 | ACJC10AH BULK | 45 |
| AC3FBV2-AU-B | AC3MMDZVB | 19 | AC5MB-AU | 12 | AC7MDZB BULK | 21 | ACJC10AHL BULK | 45 |
| AC3FBV3-AU-B | AC3MMJ | 11 | AC5MB BULK | 12 | AC7MDZ BULK | 21 | ACJC10AV2 BULK | 45 |
| AC3FBV-AU-B | AC3MMP | 22 | AC5MBJ | 12 | AC7MDZV | 21 | ACJC10AV2L BULK | 45 |
| AC3FBVL1-AU-B | AC3MMPB | 22 | AC5M BULK | 12 | AC7MDZVB | 21 | ACJC10AV BULK | 45 |
| AC3FBVL2-AU-B | AC3MMPNZ | 22 | AC5MDZ | 20 | AC7MPJ | 13 | ACJC10AVL BULK | 45 |
| AC3FBVL3-AU-B | AC3MMPNZB | 22 | AC5MDZ-AU | 20 | AC7MP | 24 | ACJC10H BULK | 48 |
| AC3FBVL-AU-B | AC3MP | 22 | AC5MDZB | 20 | AC7MPB | 24 | ACJC10HL BULK | 48 |
| AC3FCP | AC3MPB | 22 | AC5MDZB-AU | 20 | AC7MPNZ | 24 | ACJC10S BULK | 49 |
| AC3FCP-AU | AC3MPNZ | 22 | AC5MDZB BULK | 20 | AC7MPNZB | 24 | ACJC10SL BULK | 49 |
| AC3FCP BULK | AC3MPNZB | 22 | AC5MDZ BULK | 20 | AC-BNC20A | 84 | ACJC10V BULK | 48 |
| AC3FCPJ | AC4F | 12 | AC5MDZV | 20 | AC-BNC20AJ75 | 84 | ACJC10VL BULK | 48 |
| AC3FDZ | AC4F-AU | 12 | AC5MDZVB | 20 | AC-BNC20AP75 | 84 | ACJD-BLK | 116 |
| AC3FDZ-AU | AC4FB | 12 | AC5MJ | 12 | AC-BNC20B | 84 | ACJD-BLU | 116 |
| AC3FDZB | AC4FB-AU | 12 | AC5MP | 23 | AC-BNC20BJ75 | 84 | ACJD-GRN | 116 |

Amphenol

INDEX

| | | | | | | | | | |
|----------------|-----|----------------|-----|-----------------|-----|------------|-----|-----------------|-----|
| ACJD-RED | 116 | ACJS-MHOP | 103 | ACPR-BLK | 115 | AG6F | 118 | AX-BOOT-8 | 133 |
| ACJD-WHT | 116 | ACJS-MHOP-1 | 103 | ACPR-BLU | 115 | AG6FCCH | 118 | AX-BOOT-9 | 133 |
| ACJD-YEL | 116 | ACJS-MHR | 104 | ACPR-GRN | 115 | AG6FCE | 118 | AX-BOOT-CLR | 133 |
| ACJM-HHDR | 102 | ACJS-MHS | 104 | ACPR-RED | 115 | AG6FCRV | 119 | | |
| ACJM-HHOP | 103 | ACJS-MIV-3 | 105 | ACPR-SBK | 115 | AG6FL | 118 | | |
| ACJM-HHOP-1 | 103 | ACJS-MIV-3S | 105 | ACPR-SBL | 115 | AG6M | 118 | B | |
| ACJM-IH | 104 | ACJS-MIV-5 | 105 | ACPR-SGR | 115 | AG6MCC | 118 | BNC-U-LINK 75*1 | 83 |
| ACJM-IHS | 104 | ACJS-MN-3 | 105 | ACPR-SRD | 115 | AG6MCCH | 118 | E | |
| ACJM-MC | 104 | ACJS-MN-3S | 105 | ACPR-SWH | 115 | AP-4-11 | 66 | | |
| ACJM - MH | 103 | ACJS-MN-5 | 105 | ACPR-SYL | 115 | AP-4-12 | 66 | | |
| ACJM-MHD | 105 | ACJS-MV-3 | 105 | ACPR-WHT | 115 | AP-4-13 | 66 | EP-3-11P | 64 |
| ACJM-MHD985 | 102 | ACJS-MV-3S | 105 | ACPR-YEL | 115 | AP-4-14 | 66 | EP-3-11PB | 64 |
| ACJM-MHDC* | 104 | ACJS-MV-5 | 105 | ACPS-GB | 98 | AP-4-21 | 66 | EP-3-12 | 64 |
| ACJM-MHDCM | 104 | ACJS-MV35-3 | 102 | ACPS-GB-AU | 98 | AP-4-22 | 66 | EP-3-12B | 64 |
| ACJM-MHDE | 105 | ACJS-MV35-3S | 102 | ACPS-GB BULK | 98 | AP-5-11 | 66 | EP-3-13P | 65 |
| ACJM-MHDEM | 105 | ACJS-MV35-5 | 102 | ACPS-GN | 98 | AP-5-12 | 66 | EP-3-13PB | 65 |
| ACJM-MHDM | 105 | ACJS-MVD985-3 | 102 | ACPS-GN-AU | 98 | AP-5-13 | 66 | EP-3-14 | 65 |
| ACJM-MHDR | 103 | ACJS-MVD985-3S | 102 | ACPS-GN BULK | 98 | AP-5-14 | 66 | EP-3-14B | 65 |
| ACJM-MHDRM | 103 | ACJS-MVD985-5 | 102 | ACPS-KB | 96 | AP-5-21 | 66 | EP-4-11P | 64 |
| ACJM-MHOM | 103 | ACJS-MVS-3 | 106 | ACPS-KB-AU | 96 | AP-5-22 | 66 | EP-4-11PB | 64 |
| ACJM-MHOP | 103 | ACJS-MVS-3S | 106 | ACPS-KB BULK | 96 | AP-6-11 | 66 | EP-4-12 | 64 |
| ACJM-MHOP-1 | 103 | ACJS-MVS-5 | 106 | ACPS-KN | 96 | AP-6-12 | 66 | EP-4-12B | 64 |
| ACJM-MHR | 104 | ACJS-NH35 | 102 | ACPS-KN-AU | 96 | AP-6-13 | 66 | EP-4-13P | 65 |
| ACJM-MHS | 104 | ACJS-NV35-3 | 102 | ACPS-KN BULK | 96 | AP-6-14 | 66 | EP-4-13PB | 65 |
| ACJM-MIV-2 | 105 | ACJS-NV35-3S | 102 | ACPS-RB | 99 | AP-6-21 | 66 | EP-4-14 | 65 |
| ACJM-MIV-2S | 105 | ACJS-NV35-5 | 102 | ACPS-RB-AU | 99 | AP-6-22 | 66 | EP-4-14B | 65 |
| ACJM-MN-2 | 105 | ACJS-PC | 104 | ACPS-RB BULK | 99 | AP-8-11 | 66 | EP-5-11P | 64 |
| ACJM-MN-2S | 105 | ACJS - PH | 104 | ACPS-RN | 99 | AP-8-12 | 66 | EP-5-11PB | 64 |
| ACJM-MV-2 | 105 | ACJS-PHOP | 103 | ACPS-RN-AU | 99 | AP-8-13 | 66 | EP-5-12 | 64 |
| ACJM-MV-2S | 105 | ACJS-PHOP-1 | 103 | ACPS-RN BULK | 99 | AP-8-14 | 66 | EP-5-12B | 64 |
| ACJM-MV35-2 | 102 | ACJS-PHR | 104 | ACPS-TB | 97 | AP-8-21 | 66 | EP-5-13P | 65 |
| ACJM-MV35-2S | 102 | ACJS-PHS | 104 | ACPS-TB-AU | 97 | AP-8-22 | 66 | EP-5-13PB | 65 |
| ACJM-MVD985-2 | 102 | ACJS-PVB-3 | 105 | ACPS-TB BULK | 97 | AX3F | 4 | EP-5-14 | 65 |
| ACJM-MVD985-2S | 102 | ACJS-PVB-3S | 105 | ACPS-TN | 97 | AX3F-AU | 4 | EP-5-14B | 65 |
| ACJM-MVS-2 | 106 | ACJS-PVB-5 | 105 | ACPS-TN-AU | 97 | AX3FB | 4 | EP-6-11P | 64 |
| ACJM-MVS-2S | 106 | AC-NUT-BLU | 134 | ACPS-TN BULK | 97 | AX3FB-AU | 4 | EP-6-11PB | 64 |
| ACJM-NH35 | 102 | AC-NUT-BRN | 134 | AC-RING-BLU | 134 | AX3FB BULK | 4 | EP-6-12 | 64 |
| ACJM-NV35-2 | 102 | AC-NUT-GRN | 134 | AC-RING-BLU-PK1 | 134 | AX3F BULK | 4 | EP-6-12B | 64 |
| ACJM-NV35-2S | 102 | AC-NUT-GRY | 134 | AC-RING-BLU-PK2 | 134 | AX3M | 4 | EP-6-13P | 65 |
| ACJM-PC | 104 | AC-NUT-J-BLK | 134 | AC-RING-BRN | 134 | AX3M-AU | 4 | EP-6-13PB | 65 |
| ACJM - PH | 103 | AC-NUT-METAL | 134 | AC-RING-GRN | 134 | AX3MB | 4 | EP-6-14 | 65 |
| ACJM-PHOP | 103 | AC-NUT-ORG | 134 | AC-RING-GRY | 134 | AX3MB-AU | 4 | EP-6-14B | 65 |
| ACJM-PHOP-1 | 103 | AC-NUT-RED | 134 | AC-RING-ORG | 134 | AX3MB BULK | 4 | EP-8-11P | 64 |
| ACJM-PHR | 104 | AC-NUT-VIO | 134 | AC-RING-RED | 134 | AX3M BULK | 4 | EP-8-11PB | 64 |
| ACJM-PHS | 104 | AC-NUT-WHT | 134 | AC-RING-RED-PK1 | 134 | AX4F | 5 | EP-8-12 | 64 |
| ACJM-PVB-2 | 105 | AC-NUT-YEL | 134 | AC-RING-RED-PK2 | 134 | AX4F-AU | 5 | EP-8-12B | 64 |
| ACJM-PVB-2S | 105 | ACPL-CBK | 115 | AC-RING-VIO | 134 | AX4FB | 5 | EP-8-13P | 65 |
| ACJR-BLK | 115 | ACPL-CBL | 115 | AC-RING-WHT | 134 | AX4FB-AU | 5 | EP-8-13PB | 65 |
| ACJR-BLU | 115 | ACPL-CGR | 115 | AC-RING-YEL | 134 | AX4FB BULK | 5 | EP-8-14 | 65 |
| ACJR-GRN | 115 | ACPL-CRD | 115 | AC-RING-YEL-PK1 | 134 | AX4F BULK | 5 | EP-8-14B | 65 |
| ACJR-RED | 115 | ACPL-CWH | 115 | AC-RING-YEL-PK2 | 134 | AX4M | 4 | | |
| ACJR-SBK | 115 | ACPL-CYL | 115 | AG3F | 118 | AX4M-AU | 4 | H | |
| ACJR-SBL | 115 | ACPM-GB | 98 | AG3FCCH | 118 | AX4MB | 5 | HP-3-F | 62 |
| ACJR-SGR | 115 | ACPM-GB-AU | 98 | AG3FCE | 118 | AX4MB-AU | 5 | HP-3-FG | 62 |
| ACJR-SRD | 115 | ACPM-GB BULK | 98 | AG3FCRV | 119 | AX4MB BULK | 5 | HP-3-MD | 62 |
| ACJR-SWH | 115 | ACPM-GN | 98 | AG3FL | 118 | AX4M BULK | 4 | HP-3-MDG | 62 |
| ACJR-SYL | 115 | ACPM-GN-AU | 98 | AG3M | 118 | AX5F | 5 | HP-3-MDGW | 62 |
| ACJR-WHT | 115 | ACPM-GN BULK | 98 | AG3MCC | 118 | AX5F-AU | 5 | HP-3-MDW | 62 |
| ACJR-YEL | 115 | ACPM-KB | 96 | AG3MCCH | 118 | AX5FB | 5 | | |
| ACJS-HHDR | 102 | ACPM-KB-AU | 96 | AG4F | 118 | AX5FB-AU | 5 | J | |
| ACJS-HHOP | 103 | ACPM-KB BULK | 96 | AG4FCCH | 118 | AX5FB BULK | 5 | | |
| ACJS-HHOP-1 | 103 | ACPM-KN | 96 | AG4FCE | 118 | AX5F BULK | 5 | JM2P | 93 |
| ACJS-IH | 104 | ACPM-KN-AU | 96 | AG4FCRV | 119 | AX5M | 5 | JM2P-AU | 93 |
| ACJS-IHS | 104 | ACPM-KN-BULK | 96 | AG4FL | 118 | AX5M-AU | 5 | JM2PB | 93 |
| ACJS-MC | 104 | ACPM-RB | 99 | AG4M | 118 | AX5MB | 5 | JM2PB-AU | 93 |
| ACJS - MH | 104 | ACPM-RB-AU | 99 | AG4MCC | 118 | AX5MB-AU | 5 | JM2PB BULK | 93 |
| ACJS-MHD | 105 | ACPM-RB BULK | 99 | AG4MCCH | 118 | AX5MB BULK | 5 | JM2P BULK | 93 |
| ACJS-MHD985 | 102 | ACPM-RN | 99 | AG4MPCH | 119 | AX5M BULK | 5 | JS3P | 93 |
| ACJS-MHDC* | 104 | ACPM-RN-AU | 99 | AG5F | 118 | AX-BOOT | 133 | JS3P-AU | 93 |
| ACJS-MHDCM | 104 | ACPM-RN BULK | 99 | AG5FCCH | 118 | AX-BOOT-1 | 133 | JS3PB | 93 |
| ACJS-MHDE | 105 | ACPM-TB | 97 | AG5FCE | 118 | AX-BOOT-2 | 133 | JS3PB-AU | 93 |
| ACJS-MHDEM | 105 | ACPM-TB-AU | 97 | AG5FCRV | 119 | AX-BOOT-3 | 133 | JS3P BULK | 93 |
| ACJS-MHDM | 105 | ACPM-TB BULK | 97 | AG5FL | 118 | AX-BOOT-4 | 133 | | |
| ACJS-MHDR | 103 | ACPM-TN | 97 | AG5M | 118 | AX-BOOT-5 | 133 | K | |
| ACJS-MHDRM | 103 | ACPM-TN-AU | 97 | AG5MCC | 118 | AX-BOOT-6 | 133 | | |
| ACJS-MHOM | 103 | ACPM-TN BULK | 97 | AG5MCCH | 118 | AX-BOOT-7 | 133 | KM2P | 112 |

| | | | | | | | | | |
|----------------|-----|----------------|-----|---------------|-----|-------------|-----|-------------|----|
| KM2P-AU | 112 | MP-4164-54S-C | 124 | RJX8FB5HRGB | 73 | SP-2-FBSL | 53 | TM2PJ | 89 |
| KM2PB | 112 | MP-4164-85S | 124 | RJX8FB5HRGEB | 74 | SP-2-FG | 53 | TM2PN | 90 |
| KM2PB-AU | 112 | MP-4164-85S-C | 124 | RJX8FB5HRRB | 73 | SP-2-FL | 53 | TM2PN-AU | 90 |
| KM2PB BULK | 112 | MP-4164-150S | 124 | RJX8FB5HRREB | 74 | SP-2-FN | 53 | TM2PN BULK | 90 |
| KM2P BULK | 112 | MP-4164-150S-C | 124 | RJX8FB5HRYB | 73 | SP-2-FNG | 53 | TM2PNJ | 90 |
| KS3P | 112 | MP-6211-39S | 128 | RJX8FB5HRYEB | 74 | SP-2-FNL | 53 | TM2R | 90 |
| KS3P-AU | 112 | MP-6211-39S-C | 128 | RJX8FB5HUUB | 73 | SP-2-FNS | 53 | TM2RB | 90 |
| KS3PB | 112 | MP-6211-61S | 128 | RJX8FB5HUUEB | 74 | SP-2-FNSG | 53 | TM2RBJ | 90 |
| KS3PB-AU | 112 | MP-6211-61S-C | 128 | RJX8FB5VB | 74 | SP-2-FNSL | 53 | TM2RBJ-AU | 90 |
| KS3PB BULK | 112 | MP-6216-39P | 128 | RJX8FB5VEB | 74 | SP-2-FS | 53 | TM2RBJ BULK | 90 |
| KS3P BULK | 112 | MP-6216-39P-C | 128 | RJX8FB5VGRB | 74 | SP-2-FSG | 53 | TM2RJ | 90 |
| KS3PC | 112 | MP-6216-61P | 128 | RJX8FB5VGREB | 75 | SP-2-FSL | 53 | TM2RJ-AU | 90 |
| KS3PC-AU | 112 | MP-6216-61P-C | 128 | RJX8FB5VGYB | 74 | SP-2-MD | 55 | TM2RJ BULK | 90 |
| | | MP-6511-39S | 128 | RJX8FB5VGYEB | 75 | SP-2-MDH | 55 | TS3P | 89 |
| M | | MP-6511-39S-C | 128 | RJX8FB5VRGB | 74 | SP-2-MDV | 55 | TS3P-AU | 89 |
| | | MP-6511-61S | 128 | RJX8FB5VRGEB | 75 | SP-4-F | 54 | TS3PB | 89 |
| M22520/1-01 | 126 | MP-6511-61S-C | 128 | RJX8FB5VRRB | 74 | SP4F4FDW | 133 | TS3PB-AU | 89 |
| MP-738-39L | 129 | MP-6516-39P | 128 | RJX8FB5VRREB | 75 | SP-4-FB | 54 | TS3PB BULK | 89 |
| MP-738-39S | 129 | MP-6516-39P-C | 128 | RJX8FB5VRYB | 74 | SP-4-FBG | 54 | TS3PBJ | 89 |
| MP-738-61L | 129 | MP-6516-61P | 128 | RJX8FB5VRYEB | 75 | SP-4-FBL | 54 | TS3PBM | 90 |
| MP-738-61S | 129 | MP-6516-61P-C | 128 | RJX8FB5VUUB | 74 | SP-4-FBS | 54 | TS3PBM-AU | 90 |
| MP-742-39L | 129 | MP-25042-13L | 124 | RJX8FB5VUUEB | 75 | SP-4-FBSG | 54 | TS3PBM BULK | 90 |
| MP-742-39S | 129 | MP-25042-13S | 124 | RJX8FB6HB | 73 | SP-4-FBSL | 54 | TS3PBMJ | 90 |
| MP-742-61L | 129 | MP-25042-19L | 124 | RJX8FB6HEB | 73 | SP-4-FG | 54 | TS3P BULK | 89 |
| MP-742-61S | 129 | MP-25042-19S | 124 | RJX8FB6HGRB | 73 | SP-4-FL | 54 | TS3PJ | 89 |
| MP-4101-13P | 123 | MP-25042-25L | 124 | RJX8FB6HGREB | 74 | SP-4-FN | 54 | TS3PN | 90 |
| MP-4101-13P-C | 123 | MP-25042-25S | 124 | RJX8FB6HGYB | 73 | SP-4-FNG | 54 | TS3PN-AU | 90 |
| MP-4101-19P | 123 | MP-25042-37L | 124 | RJX8FB6HGYEB | 74 | SP-4-FNL | 54 | TS3PN BULK | 90 |
| MP-4101-19P-C | 123 | MP-25042-37S | 124 | RJX8FB6HRGB | 73 | SP-4-FNS | 54 | TS3PNJ | 90 |
| MP-4101-25P | 123 | MP-25042-54L | 124 | RJX8FB6HRGEB | 74 | SP-4-FNSG | 54 | TS3R | 90 |
| MP-4101-25P-C | 123 | MP-25042-54S | 124 | RJX8FB6HRRB | 73 | SP-4-FNSL | 54 | TS3RB | 90 |
| MP-4101-37P | 123 | MP-25042-85L | 124 | RJX8FB6HRRREB | 74 | SP-4-FS | 54 | TS3RBJ | 90 |
| MP-4101-37P-C | 123 | MP-25042-85S | 124 | RJX8FB6HRYB | 73 | SP-4-FSG | 54 | TS3RBJ-AU | 90 |
| MP-4101-54P | 123 | MP-25042-150L | 124 | RJX8FB6HRYEB | 74 | SP-4-FSL | 54 | TS3RBJ BULK | 90 |
| MP-4101-54P-C | 123 | MP-25042-150S | 124 | RJX8FB6HUUB | 73 | SP-4-MC | 56 | TS3RJ | 90 |
| MP-4101-85P | 123 | MP-25043-13L | 125 | RJX8FB6HUUEB | 74 | SP-4-MD | 55 | TS3RJ-AU | 90 |
| MP-4101-85P-C | 123 | MP-25043-13S | 125 | RJX8FB6VB | 74 | SP-4-MD-8 | 55 | TS3RJ BULK | 90 |
| MP-4101-150P | 123 | MP-25043-19L | 125 | RJX8FB6VEB | 74 | SP-4-MDH | 55 | | |
| MP-4101-150P-C | 123 | MP-25043-19S | 125 | RJX8FB6VGRB | 74 | SP-4-MDHT | 56 | | |
| MP-4102-13P | 124 | MP-25043-25L | 125 | RJX8FB6VGREB | 75 | SP-4-MDHT-8 | 55 | | |
| MP-4102-13P-C | 124 | MP-25043-25S | 125 | RJX8FB6VGYB | 75 | SP-4-MDT | 55 | | |
| MP-4102-19P | 124 | MP-25043-37L | 125 | RJX8FB6VGYEB | 75 | SP-4-MDV | 56 | | |
| MP-4102-19P-C | 124 | MP-25043-37S | 125 | RJX8FB6VRGB | 74 | SP-4-MDV-2 | 56 | | |
| MP-4102-25P | 124 | MP-25043-54L | 125 | RJX8FB6VRGEB | 75 | SP-4-MDVT-8 | 56 | | |
| MP-4102-25P-C | 124 | MP-25043-54S | 125 | RJX8FB6VRRB | 74 | | | | |
| MP-4102-37P | 124 | MP-25043-85L | 125 | RJX8FB6VRREB | 75 | T | | | |
| MP-4102-37P-C | 124 | MP-25043-85S | 125 | RJX8FB6VRYB | 74 | | | | |
| MP-4102-54P | 124 | MP-25043-150L | 125 | RJX8FB6VRYEB | 75 | T2860 | 133 | | |
| MP-4102-54P-C | 124 | MP-25043-150S | 125 | RJX8FB6VUUB | 74 | T2880 | 133 | | |
| MP-4102-85P | 124 | MP-108300 | 126 | RJX8FB6VUUEB | 75 | T2890 | 133 | | |
| MP-4102-85P-C | 124 | MP-108400 | 126 | RJX8FD3HB | 77 | TH29-1 | 126 | | |
| MP-4106-13S | 123 | MP-108500 | 126 | RJX8FD3VB | 77 | TM1P | 91 | | |
| MP-4106-13S-C | 123 | MP-108600 | 126 | RJX8FD5HB | 77 | TM1P-AU | 91 | | |
| MP-4106-19S | 123 | MP-EXT-16/18 | 126 | RJX8FD5I | 77 | TM1PB | 91 | | |
| MP-4106-19S-C | 123 | MP-GUIDE-16 | 126 | RJX8FD5T | 77 | TM1PB-AU | 91 | | |
| MP-4106-25S | 123 | MP-GUIDE-18 | 126 | RJX8FD5VB | 77 | TM1PB BULK | 91 | | |
| MP-4106-25S-C | 123 | MP-INS-16 | 126 | RJX8FD6HB | 77 | TM1PBJ | 91 | | |
| MP-4106-37S | 123 | MP-INS-18 | 126 | RJX8FD6I | 77 | TM1P BULK | 91 | | |
| MP-4106-37S-C | 123 | R | | RJX8FD6T | 77 | TM1PJ | 91 | | |
| MP-4106-54S | 123 | | | RJX8FD6VB | 77 | TM1RBJ | 91 | | |
| MP-4106-54S-C | 123 | RJX8FA3HB | 73 | RJX8FD6V110 | 77 | TM1RBJ-AU | 91 | | |
| MP-4106-85S | 123 | RJX8FA3VB | 74 | RJX8FD6110 | 77 | TM1RBJ BULK | 91 | | |
| MP-4106-85S-C | 123 | RJX8FA5VB | 74 | RJX8M | 70 | TM1RJ | 91 | | |
| MP-4106-150S | 123 | RJX8FA6HB | 73 | RJX8MB | 70 | TM1RJ-AU | 91 | | |
| MP-4106-150S-C | 123 | RJX8FA6VB | 74 | RJX8MB BULK | 70 | TM1RJ BULK | 91 | | |
| MP-4164-13S | 124 | RJX8FB3HB | 73 | RJX8M BULK | 70 | TM2P | 89 | | |
| MP-4164-13S-C | 124 | RJX8FB3HEB | 73 | S | | TM2P-AU | 89 | | |
| MP-4164-19S | 124 | RJX8FB3VB | 74 | SP-2-F | 53 | TM2PB | 89 | | |
| MP-4164-19S-C | 124 | RJX8FB3VEB | 74 | SP2F2FDW | 133 | TM2PB-AU | 89 | | |
| MP-4164-25S | 124 | RJX8FB5HB | 73 | SP-2-FB | 53 | TM2PB BULK | 89 | | |
| MP-4164-25S-C | 124 | RJX8FB5HGRB | 73 | SP-2-FBG | 53 | TM2PBJ | 89 | | |
| MP-4164-37S | 124 | RJX8FB5HGREB | 74 | SP-2-FBL | 53 | TM2PBM | 90 | | |
| MP-4164-37S-C | 124 | RJX8FB5HGYB | 73 | SP-2-FBS | 53 | TM2PBM-AU | 90 | | |
| MP-4164-54S | 124 | RJX8FB5HGYEB | 74 | SP-2-FBSL | 53 | TM2PBM BULK | 90 | | |
| | | | | | | TM2PBMJ | 90 | | |
| | | | | | | TM2P BULK | 89 | | |

PRODUCT SAFETY INFORMATION

This should be read in conjunction with Data Sheet information contained in individual product brochures. Failure to observe the advice in this information sheet and the operating conditions specified in the Data Sheets could result in hazardous situations.

1. Material Content and Physical Form

Electrical connectors do not usually contain hazardous materials. They contain conducting and non-conducting materials. Shells are manufactured in metal and plastic. Insulators can be formed in either natural rubber, synthetic rubber, plastic or glass insulating materials. Contact materials vary with the type of connector and its application. They are usually manufactured from either copper alloys, nickel, alumel, chromel or steel. In special applications, other alloys may be specified.

2. Fire Characteristics and Electric Shock Hazard

There is no fire hazard when the connector is correctly wired and used within the specified parameters. Incorrect wiring or assembly of the connector or careless use of metal tools or conductive fluids, or transit damage to any of the component parts may cause electric shock or burns. Live circuits must not be broken by separating mated connectors as this may cause arcing, ionisation and burning. Heat dissipation is greater at maximum resistance in a circuit. Hot spots may occur when resistance is raised locally by damage, e.g. cracked or deformed contacts, or broken strands of wire. Local overheating may also result from the use of the incorrect application tools or from poor quality soldering.

Overheating may occur if the ratings in the Data Sheets are exceeded and can cause breakdown of insulation and hence electric shock.

If heating is allowed to continue it intensifies by further increasing the local resistance through loss of temper or spring contact, formation of oxide film on contacts and wires, and leakage currents through carbonisation of insulation and tracking points. Fire can then result in the presence of combustible materials and this may release noxious fumes. Overheating may not be visually apparent. Burns may result from touching overheated components.

3. Handling

Care must be taken to avoid damage to any component parts of electrical connectors during installation and use. Although there are normally no sharp edges, care must be taken when handling certain components to avoid injury to fingers. Electrical connectors may be damaged in transit to customers, and damage may result in creation of hazards. Products should therefore be examined prior to installation/use and rejected if found to be damaged.

4. Disposal

Incineration of certain materials may release noxious or even toxic fumes.

5. Application

Connectors with exposed contacts should not be selected for use on the current supply side of an electrical circuit, because an electric shock could result from touching exposed contacts of an unmated connector. Voltages in excess of 30 V.A.C. or 42.5

V.D.C. are potentially hazardous and care should be taken to ensure that such voltages cannot be transmitted in any way to exposed metal parts of the connector body. The connector and wiring should be checked, before making live, to have no damage to metal parts or insulators, no solder blobs, loose strands, conducting lubricants, swarf, or any other undesired conducting particles. Circuit resistance and continuity check should be made to make certain that there are no low resistance joints or spurious conducting paths. Always use the correct application tools as specified in the Data Sheets. Do not permit untrained personnel to wire, assemble or tamper with connectors. For operation voltage please see appropriate national regulations.

Important General Information

A) Air and creepage paths / Operating voltage.

The admissible operating voltages depend on the individual applications and the valid national and other applicable safety regulations. For this reason the air and creepage path data are only reference values. Observe reduction of air and creepage paths due to PC board and/or harnessing.

B) Other important information

Amphenol Australia Pty Ltd continuously endeavours to improve its products. Therefore, products may deviate from the description, technical data and shape as shown in product brochures.

C) Assembly instructions

If applicable, special assembly instructions have been included in or on the connector packaging. See also separate instructions in product brochures.

DISTRIBUTED BY

Amphenol Australia Pty Ltd

22 Industry Blvd.
Carrum Downs VIC 3201
Australia

Phone: +61 3 8796 8888
Fax: +61 3 8796 8801
E-mail: info@amphenol.com.au
Web: www.amphenolaudio.com

Amphenol Audio USA

Sales Office

P.O. Box 11401
Denver CO 80211 USA

Phone: +1 720 508 3443
Email: sales@amphenolaudio.com

Warehouse

5069 Maureen Lane, Unit B
Moorpark CA 93021 USA

© 2015 Amphenol Australia Pty Ltd

Subject to all applicable laws and regulations Amphenol Australia Pty Ltd reserves the right to change specifications of any product, system or service contained in this brochure without liability.

Catalogue Part Number: CAT-AUDIO-01

Данный компонент на территории Российской Федерации

Вы можете приобрести в компании MosChip.

Для оперативного оформления запроса Вам необходимо перейти по данной ссылке:

<http://moschip.ru/get-element>

Вы можете разместить у нас заказ для любого Вашего проекта, будь то серийное производство или разработка единичного прибора.

В нашем ассортименте представлены ведущие мировые производители активных и пассивных электронных компонентов.

Нашей специализацией является поставка электронной компонентной базы двойного назначения, продукции таких производителей как XILINX, Intel (ex.ALTERA), Vicor, Microchip, Texas Instruments, Analog Devices, Mini-Circuits, Amphenol, Glenair.

Сотрудничество с глобальными дистрибьюторами электронных компонентов, предоставляет возможность заказывать и получать с международных складов практически любой перечень компонентов в оптимальные для Вас сроки.

На всех этапах разработки и производства наши партнеры могут получить квалифицированную поддержку опытных инженеров.

Система менеджмента качества компании отвечает требованиям в соответствии с ГОСТ Р ИСО 9001, ГОСТ РВ 0015-002 и ЭС РД 009

Офис по работе с юридическими лицами:

105318, г.Москва, ул.Щербаковская д.3, офис 1107, 1118, ДЦ «Щербаковский»

Телефон: +7 495 668-12-70 (многоканальный)

Факс: +7 495 668-12-70 (доб.304)

E-mail: info@moschip.ru

Skype отдела продаж:

moschip.ru

moschip.ru_4

moschip.ru_6

moschip.ru_9