



TruStability[®] Board Mount Pressure Sensors

TSC Series, Compensated/Unamplified

±60 mbar to ±10 bar | ±6 kPa to ±1 MPa | ±1 psi to ±150 psi
Millivolt Analog Output

NSC Series, Uncompensated/Unamplified

±2.5 mbar to ±10 bar | ±250 Pa to ±1 MPa | ±1 inH₂O to ±150 psi
Millivolt Analog Output



TruStability® Board Mount Pressure Sensors

Honeywell's TruStability® TSC Series and NSC Series are piezoresistive silicon pressure sensors offering a ratiometric analog output for reading pressure over the specified full scale pressure span and temperature range.

TSC Series:

- Temperature compensated and unamplified.
- Compensation makes it easier to integrate the sensor into a system by eliminating the need to calibrate the system over temperature and also offers reduced part-to-part variation.
- Compensated temperature range is 0 °C to 85 °C [-32 °F to 185 °F].
- Operating temperature range is -40 °C to 85 °C [-40 °F to 185 °F].
- Measures differential or gage pressures

NSC Series:

- Uncompensated and unamplified.
- Allows customers the flexibility of performing their own calibration while still benefiting from the industry-leading stability, accuracy, and repeatability that the Honeywell TruStability® Pressure Sensors provide.
- Operates as specified from -40 °C to 85 °C [-40 °F to 185 °F].
- Measures absolute, differential or gage pressures.

The absolute versions have an internal vacuum reference and an output value proportional to absolute pressure. Differential versions allow measurement of pressure between two pressure ports. Gage versions are referenced to atmospheric pressure and provide an output proportional to pressure variations from atmosphere.

The TSC Series and NSC Series sensors are intended for use with non-corrosive, non-ionic gases, such as air. Port 1 can also be used for non-corrosive, non-ionic liquids on sensors rated above 60 mbar | 6 kPa | 1 psi.

The TSC and NSC Series offer numerous package styles and mounting options, making it easier for device manufacturers to integrate the product into their applications. These sensors offer infinite resolution on the pressure signal. Frequency response is also typically limited only by the end user's system. All products are designed and manufactured according to ISO 9001.

Table of Contents

| | |
|---|------------|
| Features and Benefits | 3-4 |
| Potential Applications | 5 |
| TSC Series and NSC Series General Specifications | 6-7 |
| TSC Series Nomenclature and Order Guide | 8 |
| NSC Series Nomenclature and Order Guide | 9 |
| TSC Series Pressure Range Specifications | |
| ±60 mbar to ±10 bar | 10 |
| ±6 kPa to ±1 MPa | 11 |
| ±1 psi to ±150 psi | 12 |
| NSC Series Pressure Range Specifications | |
| ±2.5 mbar to ±10 bar | 13 |
| ±250 Pa to ±1 MPa | 14 |
| ±1 inH ₂ O to ±150 psi | 15 |
| Available Standard Configurations | 16-17 |
| Dimensional Drawings | |
| DIP Packages | 18-20 |
| SMT Packages | 21-23 |
| SIP Packages | 24-28 |
| Pinouts, PCB Layouts, Circuit Examples | 29 |
| TruStability® Board Mount Pressure Sensors Portfolio Overview | 30 |
| Additional Information | back cover |

What makes our sensors better?

- Stability and reliability you can count on
- Industry-leading accuracy down to ±0.15 %FSS BFSL
- Port and housing options simplify integration
- Wide pressure range from ±2.5 mbar to ±10 bar | ±250 Pa to ±1 MPa | ±1 inH₂O to ±150 psi
- Small package size
- Low power consumption

STABILITY • ACCURACY • FLEXIBILITY • SMALL SIZE

Features and Benefits

INDUSTRY-LEADING LONG-TERM STABILITY

Even after long-term use and thermal extremes, these sensors perform substantially better relative to stability than any other pressure sensor available in the industry today:

- Minimizes system calibration needs and maximizes system performance.
- Helps support system uptime by eliminating the need to service or replace the sensor during its application life.

INDUSTRY-LEADING ACCURACY

Extremely tight accuracy down to ± 0.15 %FSS BFSL:

- Reduces software needed to correct system inaccuracies, minimizing system design time.
- Supports system accuracy and warranty requirements.

Minimizes system calibration and design needs; supports system uptime.

INDUSTRY-LEADING FLEXIBILITY

- Modular, flexible design with numerous package styles, pressure ports, and options simplifies integration into the device manufacturer's application.
- Single side wet media allows the end customer to use one port of the sensor with condensing humidity or directly with non-corrosive liquid media.

Simplifies product integration.

INSENSITIVE TO MOUNTING ORIENTATION

Allows flexibility of use within the application.

SMALL SIZE

Miniature 10 mm x 10 mm [0.39 in x 0.39 in] package is very small when compared to most board mount pressure sensors:

- Occupies less area on the PCB.
- Typically allows for easy placement on crowded PCBs or in small devices.

REPEATABILITY

Provides **excellent repeatability, high accuracy and reliability** under many demanding conditions.

SUPPORTS LEAN MANUFACTURING

- J-STD-020-D MSL 1 unlimited shelf life after packaging is opened.
- System can be calibrated within one hour after reflow solder.
- Compatible with modern lead-free and no-clean solder processes.

Features and Benefits

EXTREMELY LOW POWER CONSUMPTION

- Operating supply voltage as low as 1.5 Vdc.
- Reduces power consumption, provides extended battery life, and promotes energy efficiency.

ABSOLUTE, DIFFERENTIAL AND GAGE TYPES

- Provides flexibility of use within the application.
- Absolute type on NSC Series only.

PRESSURE RANGES FROM ± 2.5 MBAR TO ± 10 BAR | ± 250 PA TO ± 1 MPA | ± 1 INH₂O TO ± 150 PSI

Optimizes the customer's system performance by maximizing pressure resolution with more available pressure ranges.

ROHS AND ISO9001 COMPLIANCE

Potential Applications



MEDICAL

- NEBULIZERS
- SPIROMETERS
- PATIENT MONITORING EQUIPMENT
- THERAPEUTIC HOSPITAL BEDS
- HOSPITAL GAS SUPPLY
- OXYGEN CONCENTRATORS
- BLOOD ANALYSIS
- GAS CHROMATOGRAPHY
- ANALYTICAL INSTRUMENTS



INDUSTRIAL

- VALVES
- PUMPS
- ACTUATORS
- HVAC TRANSMITTERS
- AUTOMATED PNEUMATIC ASSEMBLY EQUIPMENT
- PNEUMATIC OPERATOR CONTROL SYSTEMS
- INDUSTRIAL GAS SUPPLY
- BAROMETRY
- GAS CHROMATOGRAPHY
- ANALYTICAL INSTRUMENT SAMPLING SYSTEMS



TSC Series and NSC Series General Specifications

Table 1. Absolute Maximum Ratings¹

| Characteristic | Min. | Max. | Unit |
|---|------------|---|---------|
| Supply voltage (V_{supply}) ² : pressure ranges ≥ 60 mbar 6 kPa 1 psi pressure ranges ≤ 40 mbar 4 kPa 20 inH ₂ O | -12.0 0 | 12.0 7 | Vdc |
| Storage temperature | -40 [-40] | 85 [185] | °C [°F] |
| Soldering time and temperature: lead solder temperature (SIP, DIP) peak reflow temperature (SMT) | | 4 s max. at 250 °C [482 °F] 15 s max. at 250 °C [482 °F] | |

¹Absolute maximum ratings are the extreme limits the device will withstand without damage.

²Incorrect application of supply voltage or ground to the wrong pin may cause electrical failure.

Table 2. Operating Specifications

| Characteristic | Min. | Typ. | Max. | Unit |
|---|------------|------------|-------------|---------|
| Supply voltage (V_{supply}) ^{1,2} : pressure ranges ≥ 60 mbar 6 kPa 1 psi pressure ranges ≤ 40 mbar 4 kPa 20 H ₂ O | 1.5 2.7 | 5.0 5.0 | 12.0 6.5 | Vdc |
| Supply current (at 5.0 Vdc supply) TSC Series NSC Series | — — | 0.6 1.5 | 1 2.2 | mA |
| Operating temperature range ³ | -40 [-40] | — | 85 [185] | °C [°F] |
| TSC Series compensated temperature range ⁴ | 0 [32] | — | 85 [185] | °C [°F] |
| Startup time | — | — | 5 | ms |
| TSC Series output resistance | — | 2.5 | — | kOhm |

¹Ratiometricity of the sensor (the ability of the device output to scale to the supply voltage) is achieved within the specified operating voltage.

²Incorrect application of supply voltage or ground to the wrong pin may cause electrical failure.

³Operating temperature range: The temperature range over which the sensor will produce an output proportional to pressure.

⁴Compensated temperature range: The temperature range over which the sensor will produce an output proportional to pressure within the specified performance limits.

Table 3. Environmental Specifications

| Characteristic | Parameter |
|-------------------|---|
| Humidity | 0% to 95% RH, non-condensing |
| Vibration | MIL-STD-202G, Method 204D, Condition B (15 g, 10 Hz to 2 kHz) |
| Shock | MIL-STD-202G, Method 213B, Condition C (100 g, 6 ms duration) |
| Life ¹ | 1 million pressure cycles minimum |
| Solder reflow | J-STD-020-D MSL1 (unlimited shelf life when stored at less than 30 °C and 85 %RH) |

¹Life may vary depending on the specific application in which the sensor is utilized.

TSC Series and NSC Series General Specifications

Table 4. Wetted Materials¹

| Component | Port 1 (Pressure Port) | Port 2 (Reference Port) |
|-----------------------|----------------------------|----------------------------|
| Ports and covers | high temperature polyamide | high temperature polyamide |
| Substrate | alumina ceramic | alumina ceramic |
| Adhesives | epoxy, RTV | epoxy, RTV |
| Electronic components | silicon | silicon, glass, gold |

¹Contact Honeywell Customer Service for detailed material information.

CAUTION

PRODUCT DAMAGE

- Ensure liquid media is applied to Port 1 only; Port 2 is not compatible with liquids.
- Ensure liquid media contains no particulates. All TruStability® sensors are dead-ended devices. Particulates can accumulate inside the sensor, causing damage or affecting sensor output.
- Recommend that the sensor be positioned with Port 1 facing downwards; any particulates in the system are less likely to enter and settle within the pressure sensor if it is in this position.
- Ensure liquid media does not create a residue when dried; build-up inside the sensor may affect sensor output. Rinsing of a dead-ended sensor is difficult and has limited effectiveness for removing residue.
- Ensure liquid media are compatible with wetted materials. Non-compatible liquid media will degrade sensor performance and may lead to sensor failure.

Failure to comply with these instructions may result in product damage.

Table 5. Sensor Pressure Types

| Pressure Type | Description |
|---------------|--|
| Absolute | Output is proportional to the difference between applied pressure and a built-in reference to vacuum. |
| Differential | Output is proportional to the difference between the pressures applied to each port (Port 1 – Port 2). |
| Gage | Output is proportional to the difference between applied pressure and atmospheric (ambient) pressure. |

TSC Series Nomenclature and Order Guide

Figure 1. TSC Series Nomenclature and Order Guide¹

For example, **TSCDNNN150PGUCV** defines a TSC Series TruStability® Pressure Sensor, DIP package, NN pressure port, no special options, 150 psi gage pressure range, unamplified, compensated, constant supply voltage.

T S C D N N N 1 5 0 P G U C V

Series
TSC Compensated/Unamplified

Package
D DIP (Dual Inline Pin)
M SMT (Surface Mount Technology)
S SIP (Single Inline Pin)

Pressure Port

| DIP | SMT | SIP |
|--|--|---|
| NN No ports | NN No ports | NN No ports |
| — | — | AA Dual axial barbed ports, opposite sides |
| AN Single axial barbed port | AN Single axial barbed port | AN Single axial barbed port |
| LN Single axial barbless port | LN Single axial barbless port | LN Single axial barbless port |
| — | — | FF Fastener mount, dual axial barbed ports, opposite sides |
| — | — | FN Fastener mount, single axial barbed port |
| — | — | GN Ribbed fastener mount, single axial barbed port |
| — | — | NB Fastener mount, dual axial ports, same side |
| RN Single radial barbed port | RN Single radial barbed port | RN Single radial barbed port |
| RR Dual radial barbed ports, same side | RR Dual radial barbed ports, same side | RR Dual radial barbed ports, same side |
| DR Dual radial barbed ports, opposite sides | DR Dual radial barbed ports, opposite sides | DR Dual radial barbed ports, opposite sides |
| JN Single radial barbless port | JN Single radial barbless port | JN Single radial barbless port |
| JJ Dual radial barbless ports, same side | JJ Dual radial barbless ports, same side | JJ Dual radial barbless ports, same side |
| — | — | HH Fastener mount, dual radial barbed ports, same side |
| — | — | HN Fastener mount, single radial barbed port |
| — | — | MN Manifold mount, outer diameter seal |
| — | — | SN Manifold mount, inner diameter seal |

Options
N No special options

Supply Voltage
V Constant

Compensation
C Compensated

Output Type
U Unamplified

Pressure Range

| 60 mbar to 10 bar <i>Differential</i> | 6 kPa to 1 MPa <i>Differential</i> | 1 psi to 150 psi <i>Differential</i> |
|--|---------------------------------------|---|
| 060MD ±60 mbar | 006KD ±6 kPa | 001PD ±1 psi |
| 100MD ±100 mbar | 010KD ±10 kPa | 005PD ±5 psi |
| 160MD ±160 mbar | 016KD ±16 kPa | 015PD ±15 psi |
| 250MD ±250 mbar | 025KD ±25 kPa | 030PD ±30 psi |
| 400MD ±400 mbar | 040KD ±40 kPa | 060PD ±60 psi |
| 600MD ±600 mbar | 060KD ±60 kPa | 100PD ±100 psi |
| 001BD ±1 bar | 100KD ±100 kPa | 150PD ±150 psi |
| 1.6BD ±1.6 bar | 160KD ±160 kPa | |
| 2.5BD ±2.5 bar | 250KD ±250 kPa | |
| 004BD ±4 bar | 400KD ±400 kPa | |
| 006BD ±6 bar | 600KD ±600 kPa | |
| 010BD ±10 bar | 001GD ±1 MPa | |

| <i>Gage</i> | <i>Gage</i> | <i>Gage</i> |
|---------------------------------|-------------------------------|-------------------------------|
| 060MG 0 mbar to 60 mbar | 006KG 0 kPa to 6 kPa | 001PG 0 psi to 1 psi |
| 100MG 0 mbar to 100 mbar | 010KG 0 kPa to 10 kPa | 005PG 0 psi to 5 psi |
| 160MG 0 mbar to 160 mbar | 016KG 0 kPa to 16 kPa | 015PG 0 psi to 15 psi |
| 250MG 0 mbar to 250 mbar | 025KG 0 kPa to 25 kPa | 030PG 0 psi to 30 psi |
| 400MG 0 bar to 400 mbar | 040KG 0 kPa to 40 kPa | 060PG 0 psi to 60 psi |
| 600MG 0 bar to 600 mbar | 060KG 0 kPa to 60 kPa | 100PG 0 psi to 100 psi |
| 001BG 0 bar to 1 bar | 100KG 0 kPa to 100 kPa | 150PG 0 psi to 150 psi |
| 1.6BG 0 bar to 1.6 bar | 160KG 0 kPa to 160 kPa | |
| 2.5BG 0 bar to 2.5 bar | 250KG 0 kPa to 250 kPa | |
| 004BG 0 bar to 4 bar | 400KG 0 kPa to 400 kPa | |
| 006BG 0 bar to 6 bar | 600KG 0 kPa to 600 kPa | |
| 010BG 0 bar to 10 bar | 001GG 0 kPa to 1 MPa | |

¹See Table 5 for an explanation of sensor pressure types.

NSC Series Nomenclature and Order Guide

Figure 2. NSC Series Nomenclature and Order Guide¹

For example, **NSCDNNN150PGUNV** defines an NSC Series TruStability® Pressure Sensor, DIP package, NN pressure port, no special options, 150 psi gage pressure range, unamplified, uncompensated, constant supply voltage.

N S C D N N N 1 5 0 P G U N V

Series
NSC Uncompensated/Unamplified

Package
D DIP (Dual Inline Pin)
M SMT (Surface Mount Technology)
S SIP (Single Inline Pin)

Pressure Port

| DIP | SMT | SIP |
|--|--|---|
| NN No ports | NN No ports | NN No ports |
| — | — | AA Dual axial barbed ports, opposite sides |
| AN Single axial barbed port | AN Single axial barbed port | AN Single axial barbed port |
| LN Single axial barbless port | LN Single axial barbless port | LN Single axial barbless port |
| — | — | FF Fastener mount, dual axial barbed ports, opposite sides |
| — | — | FN Fastener mount, single axial barbed port |
| — | — | GN Ribbed fastener mount, single axial barbed port |
| — | — | NB Fastener mount, dual axial ports, same side |
| RN Single radial barbed port | RN Single radial barbed port | RN Single radial barbed port |
| RR Dual radial barbed ports, same side | RR Dual radial barbed ports, same side | RR Dual radial barbed ports, same side |
| DR Dual radial barbed ports, opposite sides | DR Dual radial barbed ports, opposite sides | DR Dual radial barbed ports, opposite sides |
| JN Single radial barbless port | JN Single radial barbless port | JN Single radial barbless port |
| JJ Dual radial barbless ports, same side | JJ Dual radial barbless ports, same side | JJ Dual radial barbless ports, same side |
| — | — | HH Fastener mount, dual radial barbed ports, same side |
| — | — | HN Fastener mount, single radial barbed port |
| — | — | MN Manifold mount, outer diameter seal |
| — | — | SN Manifold mount, inner diameter seal |

Options
N No special options

Supply Voltage
V Constant

Compensation
N Uncompensated

Output Type
U Unamplified

Pressure Range

| 2.5 mbar to 10 bar | 400 Pa to 1 MPa | 1 in H ₂ O to 150 psi |
|---------------------------------|-------------------------------|--|
| <i>Absolute</i> | | |
| 001BA 0 bar to 1 bar | 100KA 0 kPa to 100 kPa | 015PA 0 psi to 15 psi |
| 1.6BA 0 bar to 1.6 bar | 160KA 0 kPa to 160 kPa | 030PA 0 psi to 30 psi |
| 2.5BA 0 bar to 2.5 bar | 250KA 0 kPa to 250 kPa | 060PA 0 psi to 60 psi |
| 004BA 0 bar to 4 bar | 400KA 0 kPa to 400 kPa | 100PA 0 psi to 100 psi |
| 006BA 0 bar to 6 bar | 600KA 0 kPa to 600 kPa | 150PA 0 psi to 150 psi |
| 010BA 0 bar to 10 bar | 001GA 0 kPa to 1 MPa | |
| <i>Differential</i> | | |
| 2.5MD ±2.5 mbar | 250LD ±250 Pa | 001ND ±1 inH ₂ O |
| 004MD ±4 mbar | 400LD ±400 Pa | 002ND ±2 inH ₂ O |
| 006MD ±6 mbar | 600LD ±600 Pa | 004ND ±4 inH ₂ O |
| 010MD ±10 mbar | 001KD ±1 kPa | 005ND ±5 inH ₂ O |
| 016MD ±16 mbar | 1.6KD ±1.6 kPa | 010ND ±10 inH ₂ O |
| 025MD ±25 mbar | 2.5KD ±2.5 kPa | 020ND ±20 inH ₂ O |
| 040MD ±40 mbar | 004KD ±4 kPa | 030ND ±30 inH ₂ O |
| 060MD ±60 mbar | 006KD ±6 kPa | 001PD ±1 psi |
| 100MD ±100 mbar | 010KD ±10 kPa | 005PD ±5 psi |
| 160MD ±160 mbar | 016KD ±16 kPa | 015PD ±15 psi |
| 250MD ±250 mbar | 025KD ±25 kPa | 030PD ±30 psi |
| 400MD ±400 mbar | 040KD ±40 kPa | 060PD ±60 psi |
| 600MD ±600 mbar | 060KD ±60 kPa | 100PD ±100 psi |
| 001BD ±1 bar | 100KD ±100 kPa | 150PD ±150 psi |
| 1.6BD ±1.6 bar | 160KD ±160 kPa | |
| 2.5BD ±2.5 bar | 250KD ±250 kPa | |
| 004BD ±4 bar | 400KD ±400 kPa | |
| 006BD ±6 bar | 600KD ±600 kPa | |
| 010BD ±10 bar | 001GD ±1 MPa | |
| <i>Gage</i> | | |
| 004MG 0 mbar to 4 mbar | 400LG 0 Pa to 400 Pa | 002NG 0 inH ₂ O to 2 inH ₂ O |
| 006MG 0 mbar to 6 mbar | 600LG 0 Pa to 600 Pa | 004NG 0 inH ₂ O to 4 inH ₂ O |
| 010MG 0 mbar to 10 mbar | 001KG 0 kPa to 1 kPa | 005NG 0 inH ₂ O to 5 inH ₂ O |
| 016MG 0 mbar to 16 mbar | 1.6KG 0 kPa to 1.6 kPa | 010NG 0 inH ₂ O to 10 inH ₂ O |
| 025MG 0 mbar to 25 mbar | 004KG 0 kPa to 4 kPa | 020NG 0 inH ₂ O to 20 inH ₂ O |
| 040MG 0 mbar to 40 mbar | 006KG 0 kPa to 6 kPa | 030NG 0 inH ₂ O to 30 inH ₂ O |
| 060MG 0 mbar to 60 mbar | 010KG 0 kPa to 10 kPa | 001PG 0 psi to 1 psi |
| 100MG 0 mbar to 100 mbar | 016KG 0 kPa to 16 kPa | 005PG 0 psi to 5 psi |
| 160MG 0 mbar to 160 mbar | 025KG 0 kPa to 25 kPa | 015PG 0 psi to 15 psi |
| 250MG 0 mbar to 250 mbar | 040KG 0 kPa to 40 kPa | 030PG 0 psi to 30 psi |
| 400MG 0 bar to 400 mbar | 060KG 0 kPa to 60 kPa | 060PG 0 psi to 60 psi |
| 600MG 0 bar to 600 mbar | 100KG 0 kPa to 100 kPa | 100PG 0 psi to 100 psi |
| 001BG 0 bar to 1 bar | 160KG 0 kPa to 160 kPa | 150PG 0 psi to 150 psi |
| 1.6BG 0 bar to 1.6 bar | 250KG 0 kPa to 250 kPa | |
| 2.5BG 0 bar to 2.5 bar | 400KG 0 kPa to 400 kPa | |
| 004BG 0 bar to 4 bar | 600KG 0 kPa to 600 kPa | |
| 006BG 0 bar to 6 bar | 001GG 0 kPa to 1 MPa | |
| 010BG 0 bar to 10 bar | | |

¹See Table 5 for an explanation of sensor pressure types.

TSC Series Specifications

±60 mbar to ±10 bar

Table 6. TSC Series Pressure Range Specifications for ±60 mbar to ±10 bar

| Pressure Range Order Code (see Figure 1) | Pressure Range | | Unit | Over Pressure | Burst Pressure | Common Mode Pressure | Pressure Accuracy (%FSS) | Offset ¹ (mV/V) | Full Scale Span (mV/V) | | | Thermal Effect on Offset ² (%FSS) | | Thermal Effect on Span ³ (%FSS) | | Long-Term Stability 1000 hr, 25 °C (%FSS) | Thermal Hysteresis ⁴ (%FSS) |
|--|----------------|-------|------|---------------|----------------|----------------------|--------------------------|----------------------------|------------------------|-------|-------|--|---------------|--|---------------|---|--|
| | Pmin. | Pmax. | | | | | | | Min. | Nom. | Max. | 10 °C to 50 °C | 0 °C to 85 °C | 10 °C to 50 °C | 0 °C to 85 °C | | |
| Differential | | | | | | | | | | | | | | | | | |
| 060MD | -60 | 60 | mbar | 872 | 1370 | 10,000 | ±0.20 | ±0.075 | 2.46 | 2.60 | 2.80 | ±0.60 | ±1.15 | ±1.00 | ±2.00 | ±0.15 | ±0.15 |
| 100MD | -100 | 100 | mbar | 872 | 1370 | 10,000 | ±0.20 | ±0.075 | 4.12 | 4.40 | 4.66 | ±0.35 | ±0.70 | ±1.00 | ±2.00 | ±0.10 | ±0.10 |
| 160MD | -160 | 160 | mbar | 2000 | 4000 | 10,000 | ±0.15 | ±0.12 | 4.36 | 4.60 | 4.92 | ±0.80 | ±1.65 | ±0.75 | ±2.00 | ±0.10 | ±0.10 |
| 250MD | -250 | 250 | mbar | 2000 | 4000 | 10,000 | ±0.15 | ±0.12 | 6.82 | 7.30 | 7.70 | ±0.55 | ±1.05 | ±0.75 | ±2.00 | ±0.10 | ±0.10 |
| 400MD | -400 | 400 | mbar | 2000 | 4000 | 10,000 | ±0.15 | ±0.12 | 10.90 | 11.60 | 12.30 | ±0.35 | ±0.65 | ±0.75 | ±2.00 | ±0.10 | ±0.10 |
| 600MD | -600 | 600 | mbar | 4000 | 8000 | 10,000 | ±0.15 | ±0.075 | 5.88 | 16.10 | 6.36 | ±0.40 | ±0.85 | ±0.50 | ±1.25 | ±0.10 | ±0.10 |
| 001BD | -1 | 1 | bar | 4 | 8 | 10 | ±0.15 | ±0.075 | 9.80 | 10.20 | 10.60 | ±0.25 | ±0.50 | ±0.50 | ±1.25 | ±0.10 | ±0.10 |
| 1.6BD | -1.6 | 1.6 | bar | 4 | 8 | 10 | ±0.15 | ±0.075 | 15.68 | 16.30 | 16.96 | ±0.15 | ±0.30 | ±0.50 | ±1.25 | ±0.10 | ±0.10 |
| 2.5BD | -2.5 | 2.5 | bar | 8 | 17 | 10 | ±0.15 | ±0.075 | 12.20 | 12.70 | 13.18 | ±0.20 | ±0.40 | ±0.50 | ±1.50 | ±0.10 | ±0.10 |
| 004BD | -4 | 4 | bar | 10 | 17 | 15 | ±0.15 | ±0.075 | 11.14 | 11.60 | 12.08 | ±0.25 | ±0.50 | ±0.50 | ±1.25 | ±0.10 | ±0.10 |
| 006BD | -6 | 6 | bar | 17 | 17 | 15 | ±0.15 | ±0.075 | 10.16 | 10.60 | 11.08 | ±0.35 | ±0.50 | ±0.50 | ±1.00 | ±0.10 | ±0.10 |
| 010BD | -10 | 10 | bar | 17 | 17 | 15 | ±0.15 | ±0.075 | 16.94 | 17.70 | 18.44 | ±0.20 | ±0.3 | ±0.5 | ±1.00 | ±0.10 | ±0.10 |
| Gage | | | | | | | | | | | | | | | | | |
| 060MG | 0 | 60 | mbar | 872 | 1370 | 10,000 | ±0.20 | ±0.075 | 1.23 | 1.30 | 1.40 | ±1.15 | ±2.35 | ±1.00 | ±2.00 | ±0.30 | ±0.30 |
| 100MG | 0 | 100 | mbar | 872 | 1370 | 10,000 | ±0.20 | ±0.075 | 2.06 | 2.20 | 2.33 | ±0.70 | ±1.40 | ±1.00 | ±2.00 | ±0.20 | ±0.20 |
| 160MG | 0 | 160 | mbar | 2000 | 4000 | 10,000 | ±0.15 | ±0.12 | 2.18 | 2.30 | 2.46 | ±1.65 | ±3.30 | ±0.75 | ±2.00 | ±0.20 | ±0.20 |
| 250MG | 0 | 250 | mbar | 2000 | 4000 | 10,000 | ±0.15 | ±0.12 | 3.41 | 3.65 | 3.85 | ±1.05 | ±2.10 | ±0.75 | ±2.00 | ±0.15 | ±0.15 |
| 400MG | 0 | 400 | mbar | 2000 | 4000 | 10,000 | ±0.15 | ±0.12 | 5.45 | 5.80 | 6.15 | ±0.65 | ±1.30 | ±0.75 | ±2.00 | ±0.10 | ±0.10 |
| 600MG | 0 | 600 | mbar | 4000 | 8000 | 10,000 | ±0.15 | ±0.075 | 2.94 | 3.05 | 3.18 | ±0.85 | ±1.65 | ±0.50 | ±1.25 | ±0.15 | ±0.15 |
| 001BG | 0 | 1 | bar | 4 | 8 | 10 | ±0.15 | ±0.075 | 4.90 | 5.10 | 5.30 | ±0.50 | ±1.00 | ±0.50 | ±1.25 | ±0.10 | ±0.10 |
| 1.6BG | 0 | 1.6 | bar | 4 | 8 | 10 | ±0.15 | ±0.075 | 7.84 | 8.15 | 8.48 | ±0.30 | ±0.65 | ±0.50 | ±1.25 | ±0.10 | ±0.10 |
| 2.5BG | 0 | 2.5 | bar | 8 | 17 | 10 | ±0.15 | ±0.075 | 6.10 | 6.35 | 6.59 | ±0.40 | ±0.80 | ±0.50 | ±1.50 | ±0.10 | ±0.10 |
| 004BG | 0 | 4 | bar | 10 | 17 | 15 | ±0.15 | ±0.075 | 5.57 | 5.80 | 6.04 | ±0.50 | ±1.00 | ±0.50 | ±1.25 | ±0.10 | ±0.10 |
| 006BG | 0 | 6 | bar | 17 | 17 | 15 | ±0.15 | ±0.075 | 5.08 | 5.30 | 5.54 | ±0.65 | ±1.00 | ±0.50 | ±1.00 | ±0.15 | ±0.15 |
| 010BG | 0 | 10 | bar | 17 | 17 | 15 | ±0.15 | ±0.075 | 8.47 | 8.85 | 9.22 | ±0.40 | ±0.60 | ±0.50 | ±1.00 | ±0.10 | ±0.10 |

¹Offset: The output signal obtained when the reference pressure is applied to all available pressure ports. Also known as “null” or “zero”.

²Thermal effect on offset: The deviation in offset due to changes in temperature over the compensated temperature range, relative to offset measured at 25 °C.

³Thermal effect on span: The deviation in full scale span due to changes in temperature over the compensated temperature range, relative to full scale span measured at 25 °C.

⁴Thermal hysteresis: The maximum difference between output readings when the same temperature is reached consecutively, under the same operating conditions, with temperature approaching from opposite directions within the operating temperature range. Validated over the full operating temperature and pressure ranges using a -5 °C/minute ramp and 30 minute dwell. Application performance may be affected by the thermal mass of the end user system.

TSC Series Specifications

±6 kPa to ±1 MPa

Table 7. TSC Series Pressure Range Specifications for ±6 kPa to ±1 MPa

| Pressure Range Order Code (see Figure 1) | Pressure Range | | Unit | Over Pressure | Burst Pressure | Common Mode Pressure | Pressure Accuracy (%FSS) | Offset ¹ (mV/V) | Full Scale Span (mV/V) | | | Thermal Effect on Offset ² (%FSS) | | Thermal Effect on Span ³ (%FSS) | | Long-Term Stability 1000 hr, 25 °C (%FSS) | Thermal Hysteresis ⁴ (%FSS) |
|--|----------------|-------|------|---------------|----------------|----------------------|--------------------------|----------------------------|------------------------|-------|-------|--|---------------|--|---------------|---|--|
| | Pmin. | Pmax. | | | | | | | Min. | Nom. | Max. | 10 °C to 50 °C | 0 °C to 85 °C | 10 °C to 50 °C | 0 °C to 85 °C | | |
| Differential | | | | | | | | | | | | | | | | | |
| 006KD | -6 | 6 | kPa | 87 | 137 | 1000 | ±0.20 | ±0.075 | 2.46 | 2.60 | 2.80 | ±0.60 | ±1.15 | ±1.00 | ±2.00 | ±0.15 | ±0.15 |
| 010KD | -10 | 10 | kPa | 87 | 137 | 1000 | ±0.20 | ±0.075 | 4.12 | 4.40 | 4.66 | ±0.35 | ±0.70 | ±1.00 | ±2.00 | ±0.10 | ±0.10 |
| 016KD | -16 | 16 | kPa | 200 | 400 | 1000 | ±0.15 | ±0.12 | 4.36 | 4.60 | 4.92 | ±0.80 | ±1.65 | ±0.75 | ±2.00 | ±0.10 | ±0.10 |
| 025KD | -25 | 25 | kPa | 200 | 400 | 1000 | ±0.15 | ±0.12 | 6.82 | 7.30 | 7.70 | ±0.55 | ±1.05 | ±0.75 | ±2.00 | ±0.10 | ±0.10 |
| 040KD | -40 | 40 | kPa | 200 | 400 | 1000 | ±0.15 | ±0.12 | 10.90 | 11.60 | 12.30 | ±0.35 | ±0.65 | ±0.75 | ±2.00 | ±0.10 | ±0.10 |
| 060KD | -60 | 60 | kPa | 400 | 800 | 1000 | ±0.15 | ±0.075 | 5.88 | 16.10 | 6.36 | ±0.40 | ±0.85 | ±0.50 | ±1.25 | ±0.10 | ±0.10 |
| 100KD | -100 | 100 | kPa | 400 | 800 | 1000 | ±0.15 | ±0.075 | 9.80 | 10.20 | 10.60 | ±0.25 | ±0.50 | ±0.50 | ±1.25 | ±0.10 | ±0.10 |
| 160KD | -160 | 160 | kPa | 400 | 800 | 1000 | ±0.15 | ±0.075 | 15.68 | 16.30 | 16.96 | ±0.15 | ±0.30 | ±0.50 | ±1.25 | ±0.10 | ±0.10 |
| 250KD | -250 | 250 | kPa | 800 | 1700 | 1000 | ±0.15 | ±0.075 | 12.20 | 12.70 | 13.18 | ±0.20 | ±0.40 | ±0.50 | ±1.50 | ±0.10 | ±0.10 |
| 400KD | -400 | 400 | kPa | 1000 | 1700 | 1600 | ±0.15 | ±0.075 | 11.14 | 11.60 | 12.08 | ±0.25 | ±0.50 | ±0.50 | ±1.25 | ±0.10 | ±0.10 |
| 600KD | -600 | 600 | kPa | 1700 | 1700 | 1700 | ±0.15 | ±0.075 | 10.16 | 10.60 | 11.08 | ±0.35 | ±0.50 | ±0.50 | ±1.00 | ±0.10 | ±0.10 |
| 001GD | -1 | 1 | MPa | 1.70 | 1.70 | 1.7 | ±0.15 | ±0.075 | 16.94 | 17.70 | 18.44 | ±0.20 | ±0.30 | ±0.50 | ±1.00 | ±0.10 | ±0.10 |
| Gage | | | | | | | | | | | | | | | | | |
| 006KG | 0 | 6 | kPa | 87 | 137 | 1000 | ±0.20 | ±0.075 | 1.23 | 1.30 | 1.40 | ±1.15 | ±2.35 | ±1.00 | ±2.00 | ±0.30 | ±0.30 |
| 010KG | 0 | 10 | kPa | 87 | 137 | 1000 | ±0.20 | ±0.075 | 2.06 | 2.20 | 2.33 | ±0.70 | ±1.40 | ±1.00 | ±2.00 | ±0.20 | ±0.20 |
| 016KG | 0 | 16 | kPa | 200 | 400 | 1000 | ±0.15 | ±0.12 | 2.18 | 2.30 | 2.46 | ±1.65 | ±3.30 | ±0.75 | ±2.00 | ±0.20 | ±0.20 |
| 025KG | 0 | 25 | kPa | 200 | 400 | 1000 | ±0.15 | ±0.12 | 3.41 | 3.65 | 3.85 | ±1.05 | ±2.10 | ±0.75 | ±2.00 | ±0.15 | ±0.15 |
| 040KG | 0 | 40 | kPa | 200 | 400 | 1000 | ±0.15 | ±0.12 | 5.45 | 5.80 | 6.15 | ±0.65 | ±1.30 | ±0.75 | ±2.00 | ±0.10 | ±0.10 |
| 060KG | 0 | 60 | kPa | 400 | 800 | 1000 | ±0.15 | ±0.075 | 2.94 | 3.05 | 3.18 | ±0.85 | ±1.65 | ±0.50 | ±1.25 | ±0.15 | ±0.15 |
| 100KG | 0 | 100 | kPa | 400 | 800 | 1000 | ±0.15 | ±0.075 | 4.90 | 5.10 | 5.30 | ±0.50 | ±1.00 | ±0.50 | ±1.25 | ±0.10 | ±0.10 |
| 160KG | 0 | 160 | kPa | 400 | 800 | 1000 | ±0.15 | ±0.075 | 7.84 | 8.15 | 8.48 | ±0.30 | ±0.65 | ±0.50 | ±1.25 | ±0.10 | ±0.10 |
| 250KG | 0 | 250 | kPa | 800 | 1700 | 1000 | ±0.15 | ±0.075 | 6.10 | 6.35 | 6.59 | ±0.40 | ±0.80 | ±0.50 | ±1.50 | ±0.10 | ±0.10 |
| 400KG | 0 | 400 | kPa | 1000 | 1700 | 1600 | ±0.15 | ±0.075 | 5.57 | 5.80 | 6.04 | ±0.50 | ±1.00 | ±0.50 | ±1.25 | ±0.10 | ±0.10 |
| 600KG | 0 | 600 | kPa | 1700 | 1700 | 1700 | ±0.15 | ±0.075 | 5.08 | 5.30 | 5.54 | ±0.65 | ±1.00 | ±0.50 | ±1.00 | ±0.15 | ±0.15 |
| 001GG | 0 | 1 | MPa | 1.70 | 1.70 | 1.7 | ±0.15 | ±0.075 | 8.47 | 8.85 | 9.22 | ±0.40 | ±0.60 | ±0.50 | ±1.00 | ±0.10 | ±0.10 |

¹Offset: The output signal obtained when the reference pressure is applied to all available pressure ports. Also known as “null” or “zero”.

²Thermal effect on offset: The deviation in offset due to changes in temperature over the compensated temperature range, relative to offset measured at 25 °C.

³Thermal effect on span: The deviation in full scale span due to changes in temperature over the compensated temperature range, relative to full scale span measured at 25 °C.

⁴Thermal hysteresis: The maximum difference between output readings when the same temperature is reached consecutively, under the same operating conditions, with temperature approaching from opposite directions within the operating temperature range. Validated over the full operating temperature and pressure ranges using a ~5 °C/minute ramp and 30 minute dwell. Application performance may be affected by the thermal mass of the end user system.

TSC Series Specifications

±1 psi to ±150 psi

Table 8. TSC Series Pressure Range Specifications for ±1 psi to ±150 psi

| Pressure Range Order Code (see Figure 1) | Pressure Range | | Unit | Over Pressure | Burst Pressure | Common Mode Pressure | Pressure Accuracy (%FSS) | Offset ¹ (mV/V) | Full Scale Span (mV/V) | | | Thermal Effect on Offset ² (%FSS) | | Thermal Effect on Span ³ (%FSS) | | Long-Term Stability 1000 hr, 25 °C (%FSS) | Thermal Hysteresis ⁴ (%FSS) |
|--|----------------|-------|------|---------------|----------------|----------------------|--------------------------|----------------------------|------------------------|-------|-------|--|---------------|--|---------------|---|--|
| | Pmin. | Pmax. | | | | | | | Min. | Norm. | Max. | 10 °C to 50 °C | 0 °C to 85 °C | 10 °C to 50 °C | 0 °C to 85 °C | | |
| Differential | | | | | | | | | | | | | | | | | |
| 001PD | -1 | 1 | psi | 12.5 | 20 | 145 | ±0.20 | ±0.075 | 2.84 | 3.00 | 3.22 | ±0.50 | ±1.00 | ±1.00 | ±2.00 | ±0.15 | ±0.15 |
| 005PD | -5 | 5 | psi | 30 | 60 | 145 | ±0.15 | ±0.12 | 9.40 | 10.00 | 10.60 | ±0.40 | ±0.75 | ±0.75 | ±2.00 | ±0.10 | ±0.10 |
| 015PD | -15 | 15 | psi | 60 | 115 | 145 | ±0.15 | ±0.075 | 10.12 | 10.50 | 10.98 | ±0.25 | ±0.50 | ±0.50 | ±1.25 | ±0.10 | ±0.10 |
| 030PD | -30 | 30 | psi | 115 | 245 | 145 | ±0.15 | ±0.075 | 10.10 | 10.50 | 10.90 | ±0.25 | ±0.50 | ±0.50 | ±1.50 | ±0.10 | ±0.10 |
| 060PD | -60 | 60 | psi | 145 | 245 | 230 | ±0.15 | ±0.075 | 11.52 | 12.00 | 12.48 | ±0.25 | ±0.50 | ±0.50 | ±1.25 | ±0.10 | ±0.10 |
| 100PD | -100 | 100 | psi | 245 | 245 | 245 | ±0.15 | ±0.075 | 11.66 | 12.00 | 12.72 | ±0.30 | ±0.45 | ±0.50 | ±1.00 | ±0.10 | ±0.10 |
| 150PD | -150 | 150 | psi | 245 | 245 | 245 | ±0.15 | ±0.075 | 17.50 | 18.30 | 19.08 | ±0.20 | ±0.30 | ±0.50 | ±1.00 | ±0.10 | ±0.10 |
| Gage | | | | | | | | | | | | | | | | | |
| 001PG | 0 | 1 | psi | 12.7 | 20 | 145 | ±0.20 | ±0.075 | 1.42 | 1.50 | 1.61 | ±1.00 | ±2.05 | ±1.00 | ±2.00 | ±0.25 | ±0.25 |
| 005PG | 0 | 5 | psi | 30 | 60 | 145 | ±0.15 | ±0.12 | 4.70 | 5.00 | 5.30 | ±0.75 | ±1.50 | ±0.75 | ±2.00 | ±0.10 | ±0.10 |
| 015PG | 0 | 15 | psi | 60 | 115 | 145 | ±0.15 | ±0.075 | 5.06 | 5.25 | 5.49 | ±0.50 | ±0.95 | ±0.50 | ±1.25 | ±0.10 | ±0.10 |
| 030PG | 0 | 30 | psi | 115 | 245 | 145 | ±0.15 | ±0.075 | 5.05 | 5.25 | 5.45 | ±0.50 | ±0.95 | ±0.50 | ±1.50 | ±0.10 | ±0.10 |
| 060PG | 0 | 60 | psi | 145 | 245 | 230 | ±0.15 | ±0.075 | 5.76 | 6.00 | 6.24 | ±0.50 | ±0.95 | ±0.50 | ±1.25 | ±0.10 | ±0.10 |
| 100PG | 0 | 100 | psi | 245 | 245 | 245 | ±0.15 | ±0.075 | 5.83 | 6.10 | 6.36 | ±0.60 | ±0.85 | ±0.50 | ±1.00 | ±0.10 | ±0.10 |
| 150PG | 0 | 150 | psi | 245 | 245 | 245 | ±0.15 | ±0.075 | 8.75 | 9.15 | 9.54 | ±0.40 | ±0.60 | ±0.50 | ±1.00 | ±0.10 | ±0.10 |

¹Offset: The output signal obtained when the reference pressure is applied to all available pressure ports. Also known as “null” or “zero”.

²Thermal Effect on Offset: The deviation in offset due to changes in temperature over the compensated temperature range, relative to offset measured at 25 °C.

³Thermal Effect on Span: The deviation in full scale span due to changes in temperature over the compensated temperature range, relative to full scale span measured at 25 °C.

⁴Thermal Hysteresis: The maximum difference between output readings when the same temperature is reached consecutively, under the same operating conditions, with temperature approaching from opposite directions within the operating temperature range. Validated over the full operating temperature and pressure ranges using a ~5 °C/minute ramp and 30 minute dwell. Application performance may be affected by the thermal mass of the end user system.

Figure 3. TSC Series Typical Temperature Performance

The graph below indicates typical error multipliers for Thermal Effect on Offset (TEO) and Thermal Effect on Span (TES) outside the Compensated Temperature Range. See Tables 6-8 for details of the specified maximum errors within the Compensated Temperature Range.



NSC Series Specifications

±1 in H₂O to ±150 psi

Table 11. NSC Series Pressure Range Specifications for ±1 inH₂O to ±150 psi

| Pressure Range Order Code (see Figure 2) | Pressure Range | | Unit | Working Pressure | Over Pressure | Burst Pressure | Common Mode Pressure | Offset ¹ (mV/V) | | | Full Scale Span (mV/V) | | | TCO ² (%FSS/25 °C) | | | TCS ³ (%FSS/25 °C) | | | Input Resistance ³ (kOhm) | | | TCR ⁴ (-40°C to 25°C) (ppm/°C) | | | TCR ⁵ (25 °C to 85 °C) (ppm/°C) | | | Long-Term Stability 1000 hr, 25 °C (%FSS) | Accuracy (%FSS) |
|--|----------------|-------|--------------------|------------------|---------------|----------------|----------------------|----------------------------|-------|------|------------------------|------|------|-------------------------------|------|------|-------------------------------|------|------|--------------------------------------|------|------|---|------|------|--|------|------|---|-----------------|
| | Pmin. | Pmax. | | | | | | Min. | Nom. | Max. | Min. | Nom. | Max. | Min. | Nom. | Max. | Min. | Nom. | Max. | Min. | Nom. | Max. | Min. | Nom. | Max. | Min. | Nom. | Max. | | |
| Absolute | | | | | | | | | | | | | | | | | | | | | | | | | | | | | | |
| 015PA | 0 | 15 | psi | - | 30 | 60 | N/A | -6.0 | 0 | 6.0 | 10.3 | 15.0 | 19.7 | -3.6 | 0.0 | 3.6 | -7.5 | -5.0 | -3.0 | 2.6 | 3.5 | 4.4 | 500 | 1000 | 1500 | 1500 | 2000 | 2500 | ±0.25 | ±0.25 |
| 030PA | 0 | 30 | psi | - | 60 | 120 | N/A | -6.0 | 0 | 6.0 | 9.9 | 14.8 | 19.7 | -3.8 | 0.0 | 3.8 | -7.5 | -5.0 | -3.0 | 2.6 | 3.5 | 4.4 | 500 | 1000 | 1500 | 1500 | 2000 | 2500 | ±0.25 | ±0.25 |
| 060PA | 0 | 60 | psi | - | 120 | 250 | N/A | -6.0 | 0 | 6.0 | 10.7 | 15.2 | 19.7 | -3.5 | 0.0 | 3.5 | -7.5 | -5.0 | -3.0 | 2.6 | 3.5 | 4.4 | 500 | 1000 | 1500 | 1500 | 2000 | 2500 | ±0.25 | ±0.25 |
| 100PA | 0 | 100 | psi | - | 250 | 250 | N/A | -6.0 | 0 | 6.0 | 9.1 | 12.6 | 16.1 | -4.10 | 0.0 | 4.10 | -7.5 | -5.0 | -3.0 | 2.6 | 3.5 | 4.4 | 500 | 1000 | 1500 | 1500 | 2000 | 2500 | ±0.25 | ±0.25 |
| 150PA | 0 | 150 | psi | - | 250 | 250 | N/A | -6.0 | 0 | 6.0 | 13.6 | 18.9 | 24.2 | -2.8 | 0.0 | 2.8 | -7.5 | -5.0 | -3.0 | 2.6 | 3.5 | 4.4 | 500 | 1000 | 1500 | 1500 | 2000 | 2500 | ±0.20 | ±0.25 |
| Differential | | | | | | | | | | | | | | | | | | | | | | | | | | | | | | |
| 001ND | -1 | 1 | inH ₂ O | 135 | 270 | 415 | 1400 | -24 | -4 | 16 | 10.5 | 15.7 | 21.0 | -3.0 | 5.2 | 13.3 | -8.9 | -6 | -3.8 | 2.5 | 3.3 | 4 | 1800 | 2175 | 2550 | 1300 | 1525 | 1750 | 0.50 | ±0.25 |
| 002ND | -2 | 2 | inH ₂ O | 135 | 270 | 415 | 1400 | -24 | -4 | 16 | 21.0 | 31.5 | 42.0 | -1.5 | 2.6 | 6.7 | -8.9 | -6 | -3.8 | 2.5 | 3.3 | 4 | 1800 | 2175 | 2550 | 1300 | 1525 | 1750 | 0.25 | ±0.25 |
| 004ND | -4 | 4 | inH ₂ O | 150 | 300 | 500 | 2200 | -24 | -4 | 16 | 35.0 | 52.4 | 69.8 | -1.3 | 1.8 | 5.5 | -8.9 | -6 | -3.8 | 2.5 | 3.3 | 4 | 1800 | 2175 | 2550 | 1300 | 1525 | 1750 | 0.25 | ±0.25 |
| 005ND | -5 | 5 | inH ₂ O | 150 | 300 | 500 | 2200 | -24 | -4 | 16 | 43.8 | 65.5 | 87.2 | -1.5 | 1.4 | 4.4 | -8.9 | -6 | -3.8 | 2.5 | 3.3 | 4 | 1800 | 2175 | 2550 | 1300 | 1525 | 1750 | 0.20 | ±0.25 |
| 010ND | -10 | 10 | inH ₂ O | 175 | 340 | 550 | 4200 | -8.0 | -2.0 | 4.0 | 10.5 | 15.7 | 21.0 | -2.0 | 0.5 | 3.0 | -8.9 | -6 | -3.8 | 2.5 | 3.3 | 4 | 1800 | 2175 | 2550 | 1300 | 1525 | 1750 | 0.25 | ±0.25 |
| 020ND | -20 | 20 | inH ₂ O | 175 | 340 | 550 | 4200 | -8.5 | -2.5 | 3.5 | 6.5 | 9.4 | 12.3 | -1.5 | 0.7 | 1.5 | -6.3 | -5 | -3.8 | 4 | 5 | 6 | 1200 | 1700 | 2200 | 2200 | 2700 | 3200 | 0.25 | ±0.25 |
| 030ND | -30 | 30 | inH ₂ O | 175 | 340 | 550 | 4200 | -8.5 | -2.5 | 3.5 | 9.8 | 14.1 | 18.4 | -1.0 | 0.5 | 1.0 | -6.3 | -5 | -3.8 | 4 | 5 | 6 | 1200 | 1700 | 2200 | 2200 | 2700 | 3200 | 0.15 | ±0.25 |
| 001PD | -1 | 1 | psi | 5 | 10 | 20 | 150 | -8.5 | -2.5 | 3.5 | 9.0 | 13.0 | 17.0 | -1.1 | 0.5 | 1.1 | -6.3 | -5 | -3.8 | 4 | 5 | 6 | 1200 | 1700 | 2200 | 2200 | 2700 | 3200 | 0.20 | ±0.25 |
| 005PD | -5 | 5 | psi | - | 20 | 40 | 150 | -8.5 | -2.5 | 3.5 | 20.0 | 30.0 | 40.0 | -0.5 | 0.2 | 0.5 | -6.3 | -5 | -3.8 | 4 | 5 | 6 | 1200 | 1700 | 2200 | 2200 | 2700 | 3200 | 0.20 | ±0.25 |
| 015PD | -15 | 15 | psi | - | 30 | 60 | 150 | -7.0 | -0.85 | 5.3 | 20.7 | 31.0 | 41.4 | -0.5 | 0.3 | 0.5 | -6 | -5 | -3.8 | 2.4 | 3 | 5.5 | 1200 | 1700 | 2200 | 2200 | 2700 | 3200 | 0.15 | ±0.25 |
| 030PD | -30 | 30 | psi | - | 60 | 120 | 150 | -7.0 | -0.85 | 5.3 | 31.0 | 41.4 | 51.7 | -0.3 | 0.2 | 0.3 | -6 | -5 | -3.8 | 2.4 | 3 | 5.5 | 1200 | 1700 | 2200 | 2200 | 2700 | 3200 | 0.15 | ±0.25 |
| 060PD | -60 | 60 | psi | - | 120 | 250 | 250 | -7.0 | -0.85 | 5.3 | 34.8 | 41.4 | 48.0 | -0.3 | 0.2 | 0.3 | -6 | -5 | -3.8 | 2.4 | 3 | 5.5 | 1200 | 1700 | 2200 | 2200 | 2700 | 3200 | 0.15 | ±0.25 |
| 100PD | -100 | 100 | psi | - | 250 | 250 | 250 | -7.0 | -0.85 | 5.3 | 29.0 | 34.5 | 40.0 | -0.3 | 0.3 | 0.3 | -6 | -5 | -3.8 | 2.4 | 3 | 5.5 | 1200 | 1700 | 2200 | 2200 | 2700 | 3200 | 0.15 | ±0.25 |
| 150PD | -150 | 150 | psi | - | 250 | 250 | 250 | -7.0 | -0.85 | 5.3 | 43.4 | 51.7 | 60.0 | -0.2 | 0.2 | 0.2 | -6 | -5 | -3.8 | 2.4 | 3 | 5.5 | 1200 | 1700 | 2200 | 2200 | 2700 | 3200 | 0.10 | ±0.25 |
| Gage | | | | | | | | | | | | | | | | | | | | | | | | | | | | | | |
| 002NG | 0 | 2 | inH ₂ O | 135 | 270 | 415 | 1400 | -24 | -4 | 16 | 10.5 | 15.7 | 21.0 | -3.0 | 5.2 | 13.3 | -8.9 | -6 | -3.8 | 2.5 | 3.3 | 4 | 1800 | 2175 | 2550 | 1300 | 1525 | 1750 | 0.50 | ±0.25 |
| 004NG | 0 | 4 | inH ₂ O | 150 | 300 | 500 | 2200 | -24 | -4 | 16 | 17.5 | 26.2 | 34.9 | -3.8 | 3.6 | 11.0 | -8.9 | -6 | -3.8 | 2.5 | 3.3 | 4 | 1800 | 2175 | 2550 | 1300 | 1525 | 1750 | 0.50 | ±0.25 |
| 005NG | 0 | 5 | inH ₂ O | 150 | 300 | 500 | 2200 | -24 | -4 | 16 | 21.9 | 32.7 | 43.6 | -3.0 | 2.9 | 8.8 | -8.9 | -6 | -3.8 | 2.5 | 3.3 | 4 | 1800 | 2175 | 2550 | 1300 | 1525 | 1750 | 0.40 | ±0.25 |
| 010NG | 0 | 10 | inH ₂ O | 175 | 340 | 550 | 4200 | -8.0 | -2.0 | 4.0 | 5.2 | 7.9 | 10.5 | -4.0 | 1.0 | 6.0 | -8.9 | -6 | -3.8 | 2.5 | 3.3 | 4 | 1800 | 2175 | 2550 | 1300 | 1525 | 1750 | 0.50 | ±0.25 |
| 020NG | 0 | 20 | inH ₂ O | 175 | 340 | 550 | 4200 | -8.5 | -2.5 | 3.5 | 3.3 | 4.7 | 6.1 | -3.0 | 1.4 | 3.0 | -6.3 | -5 | -3.8 | 4 | 5 | 6 | 1200 | 1700 | 2200 | 2200 | 2700 | 3200 | 0.50 | ±0.25 |
| 030NG | 0 | 30 | inH ₂ O | 175 | 340 | 550 | 4200 | -8.5 | -2.5 | 3.5 | 4.9 | 7.0 | 9.2 | -2.0 | 0.9 | 2.0 | -6.3 | -5 | -3.8 | 4 | 5 | 6 | 1200 | 1700 | 2200 | 2200 | 2700 | 3200 | 0.30 | ±0.25 |
| 001PG | 0 | 1 | psi | 5 | 10 | 20 | 150 | -8.5 | -2.5 | 3.5 | 4.5 | 6.5 | 8.5 | -2.2 | 1.0 | 2.2 | -6.3 | -5 | -3.8 | 4 | 5 | 6 | 1200 | 1700 | 2200 | 2200 | 2700 | 3200 | 0.35 | ±0.25 |
| 005PG | 0 | 5 | psi | - | 20 | 40 | 150 | -8.5 | -2.5 | 3.5 | 10.0 | 15.0 | 20.0 | -1.0 | 0.4 | 1.0 | -6.3 | -5 | -3.8 | 4 | 5 | 6 | 1200 | 1700 | 2200 | 2200 | 2700 | 3200 | 0.35 | ±0.25 |
| 015PG | 0 | 15 | psi | - | 30 | 60 | 150 | -7.0 | -0.85 | 5.3 | 10.3 | 15.5 | 20.7 | -1.0 | 0.6 | 1.0 | -6.0 | -5 | -3.8 | 2.4 | 3 | 5.5 | 1200 | 1700 | 2200 | 2200 | 2700 | 3200 | 0.25 | ±0.25 |
| 030PG | 0 | 30 | psi | - | 60 | 120 | 150 | -7.0 | -0.85 | 5.3 | 15.5 | 20.7 | 25.9 | -0.6 | 0.4 | 0.6 | -6.0 | -5 | -3.8 | 2.4 | 3 | 5.5 | 1200 | 1700 | 2200 | 2200 | 2700 | 3200 | 0.25 | ±0.25 |
| 060PG | 0 | 60 | psi | - | 120 | 250 | 250 | -7.0 | -0.85 | 5.3 | 17.4 | 20.7 | 24.0 | -0.6 | 0.4 | 0.6 | -6.0 | -5 | -3.8 | 2.4 | 3 | 5.5 | 1200 | 1700 | 2200 | 2200 | 2700 | 3200 | 0.25 | ±0.25 |
| 100PG | 0 | 100 | psi | - | 250 | 250 | 250 | -7.0 | -0.85 | 5.3 | 14.5 | 17.2 | 20.0 | -0.7 | 0.5 | 0.7 | -6.0 | -5 | -3.8 | 2.4 | 3 | 5.5 | 1200 | 1700 | 2200 | 2200 | 2700 | 3200 | 0.25 | ±0.25 |
| 150PG | 0 | 150 | psi | - | 250 | 250 | 250 | -7.0 | -0.85 | 5.3 | 21.7 | 25.9 | 30.0 | -0.6 | 0.3 | 0.6 | -6.0 | -5 | -3.8 | 2.4 | 3 | 5.5 | 1200 | 1700 | 2200 | 2200 | 2700 | 3200 | 0.20 | ±0.25 |

¹Offset: The output signal obtained when the reference pressure is applied to all available pressure ports. Also known as “null” or “zero”.

²TCO (Thermal Coefficient of Offset): The deviation in offset due to changes in temperature over the compensated temperature range, relative to offset measured at 25 °C.

³TCS (Thermal Coefficient of Span): The deviation in full scale span due to changes in temperature over the compensated temperature range, relative to full scale span measured at 25 °C.

⁴Input Resistance at 25 °C, 5 Vdc supply.

⁵TCR (Thermal Coefficient of Resistance): The deviation in input resistance due to changes in temperature over the specified temperature range, relative to input resistance measured at 25 °C.

Available Standard Configurations

Figure 4. All Available Standard Configurations (Dimensional drawings on pages noted below.)

| Package Code | Pressure Port | | |
|--------------|---|---|---|
| | DIP | SMT | SIP |
| NN |  <i>page 18</i> |  <i>page 20</i> |  <i>page 23</i> |
| AA | — | — |  <i>page 23</i> |
| AN |  <i>page 18</i> |  <i>page 21</i> |  <i>page 24</i> |
| LN |  <i>page 18</i> |  <i>page 21</i> |  <i>page 24</i> |
| FF | — | — |  <i>page 24</i> |
| FN | — | — |  <i>page 25</i> |
| GN | — | — |  <i>page 25</i> |
| NB | — | — |  <i>page 25</i> |
| RN |  <i>page 19</i> |  <i>page 21</i> |  <i>page 26</i> |

Available Standard Configurations

Figure 4. All Available Standard Configurations (Continued; dimensional drawings on pages noted below.)

| Package Code | Pressure Port | | |
|--------------|--|--|---|
| | DIP | SMT | SIP |
| RR |  <i>page 19</i> |  <i>page 22</i> |  <i>page 26</i> |
| DR |  <i>page 19</i> |  <i>page 22</i> |  <i>page 26</i> |
| JN |  <i>page 20</i> |  <i>page 22</i> |  <i>page 27</i> |
| JJ |  <i>page 20</i> |  <i>page 23</i> |  <i>page 27</i> |
| HH | — | — |  <i>page 27</i> |
| HN | — | — |  <i>page 28</i> |
| MN | — | — |  <i>page 28</i> |
| SN | — | — |  <i>page 28</i> |

Dimensional Drawings

DIP Packages

Figure 5. DIP Package Dimensional Drawings (For reference only: mm [in])

Dimensions

DIP NN: No ports



DIP AN: Single axial barbed port

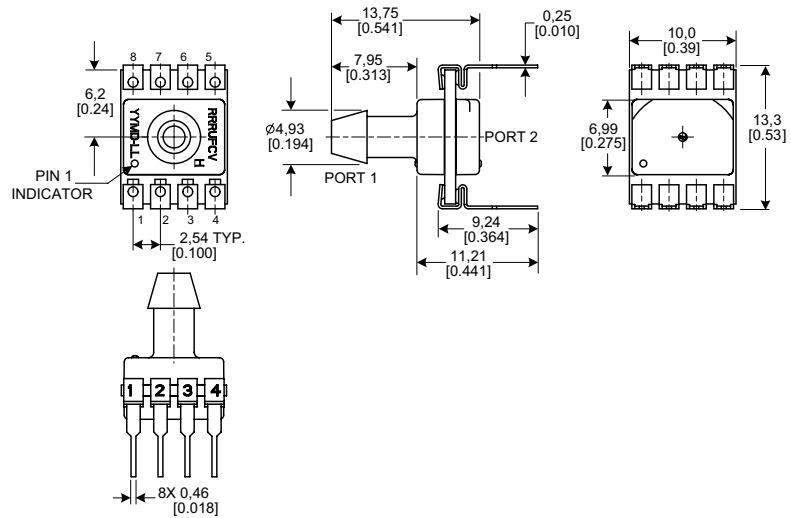

DIP LN: Single axial barbless port

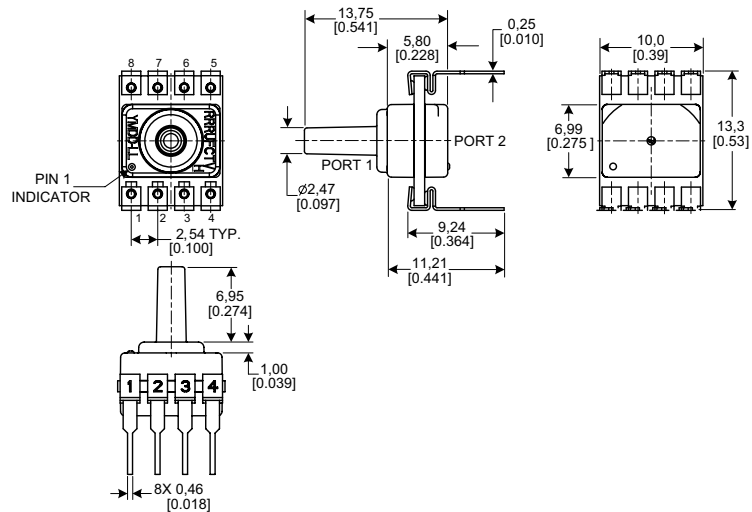

Dimensional Drawings

DIP Packages

Figure 5. DIP Package Dimensional Drawings (continued)

Dimensions

DIP RN: Single radial barbed port

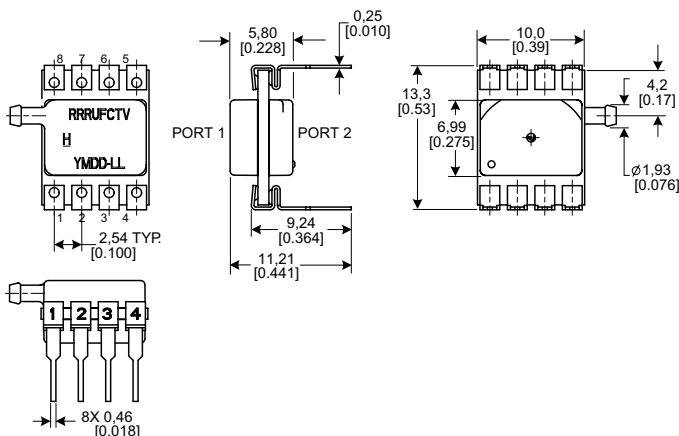
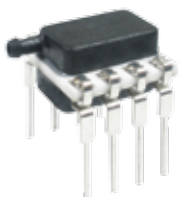

DIP RR: Dual radial barbed ports, same side

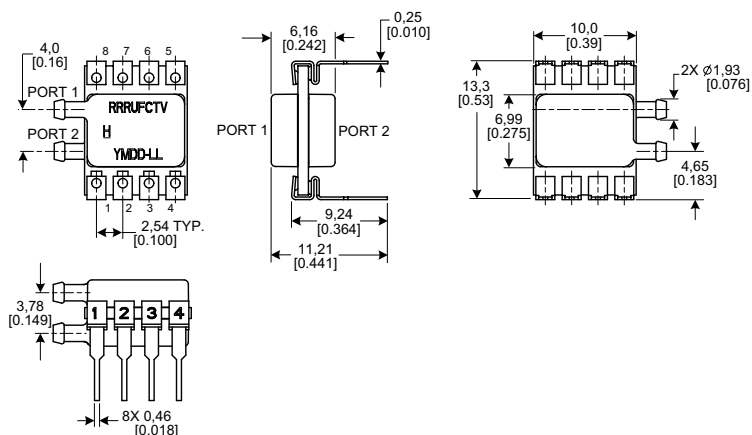
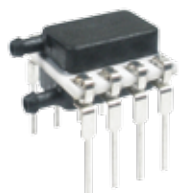

DIP DR: Dual radial barbed ports, opposite sides

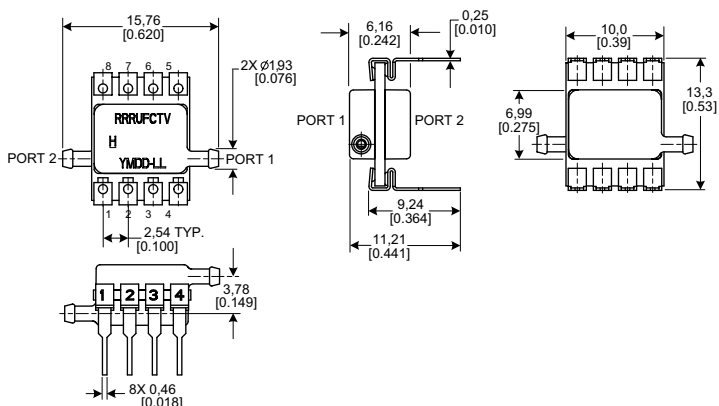

Dimensional Drawings DIP and SMT Packages

Figure 5. DIP Package Dimensional Drawings (continued)



Figure 6. SMT Package Dimensional Drawings (For reference only: mm [in])



Dimensional Drawings

SMT Packages

Figure 6. SMT Package Dimensional Drawings (continued)

Dimensions

SMT AN: Single axial barbless port



SMT LN: Single axial barbless port



SMT RN: Single radial barbed port



Dimensional Drawings

SMT Packages

Figure 6. SMT Package Dimensional Drawings (continued)

Dimensions

SMT RR: Dual radial barbed ports, same side



SMT DR: Dual radial barbed ports, opposite sides



SMT JN: Single radial barbless port



Dimensional Drawings

SMT and SIP Packages

Figure 6. SMT Package Dimensional Drawings (continued)



Figure 7. SIP Package Dimensional Drawings (For reference only: mm [in.]



Dimensional Drawings

SIP Packages

Figure 7. SIP Package Dimensional Drawings (continued)

Dimensions

SIP AN: Single axial barbed port



SIP LN: Single axial barbless port



SIP FF: Fastener mount, dual axial barbed ports, opposite sides



Dimensional Drawings

SIP Packages

Figure 7. SIP Package Dimensional Drawings (continued)

Dimensions

SIP FN: Fastener mount, single axial barbed port



SIP GN: Ribbed fastener mount, single axial barbed port



SIP NB: Fastener mount, dual axial ports, same side



Dimensional Drawings

SIP Packages

Figure 7. SIP Package Dimensional Drawings (continued)

Dimensions

SIP RN: Single radial barbed port



SIP RR: Dual radial barbed ports, same side



SIP DR: Dual radial barbed ports, opposite sides



Dimensional Drawings

SIP Packages

Figure 7. SIP Package Dimensional Drawings (continued)

Dimensions

SIP JN: Single radial barbless port



SIP JJ: Dual radial barbless ports, same side



SIP HH: Fastener mount dual radial barbed ports, same side



Dimensional Drawings

SIP Packages

Figure 7. SIP Package Dimensional Drawings (continued)



Pinout, PCB Pad Layout, Circuit Examples

Table 12. Pinout for DIP and SMT Packages

| Output Type | Pin 1 | Pin 2 | Pin 3 | Pin 4 | Pin 5 | Pin 6 | Pin 7 | Pin 8 |
|-------------|-------|-------------------|---------------------|-------------------|-------|-------|-------|-------|
| analog | GND | V _{out+} | V _{supply} | V _{out-} | NC | NC | NC | NC |

Table 13. Pinout for SIP Packages

| Output Type | Pin 1 | Pin 2 | Pin 3 | Pin 4 |
|-------------|-------|-------------------|---------------------|-------------------|
| analog | GND | V _{out+} | V _{supply} | V _{out-} |

Figure 8. Recommended PCB Pad Layouts



Figure 9. Circuit Examples



TruStability® Board Mount Pressure Sensors Portfolio Overview

Table 14. TruStability® Board Mount Pressure Sensors Portfolio Overview

| Characteristic | Series | | | |
|--|--------|-----|-----|-----|
| | HSC | SSC | TSC | NSC |
| Package: | | | | |
| DIP (Dual In-Line Pin) | ✓ | ✓ | ✓ | ✓ |
| SMT (Surface Mount Technology) | ✓ | ✓ | ✓ | ✓ |
| SIP (Single In-Line Pin) | ✓ | ✓ | ✓ | ✓ |
| Option: | | | | |
| dry gases only, no diagnostics (all pressure ranges) | ✓ | ✓ | ✓ | ✓ |
| dry gases only, diagnostics on (all pressure ranges) | ✓ | ✓ | — | — |
| liquid media on port 1, no diagnostics (±60 mbar to ±10 bar ±6 kPa to ±1 MPa ±1 psi to ±150 psi) | ✓ | ✓ | ✓ | ✓ |
| liquid media on port 1, diagnostics on (±60 mbar to ±10 bar ±6 kPa to ±1 MPa ±1 psi to ±150 psi) | ✓ | ✓ | — | — |
| Pressure range: | | | | |
| Absolute: | | | | |
| 1 bar to 10 bar 100 kPa to 1 MPa 15 psi to 150 psi | ✓ | ✓ | — | ✓ |
| Differential: | | | | |
| ±60 mbar to ±10 bar ±6 kPa to ±1 MPa ±1 psi to ±150 psi | ✓ | ✓ | ✓ | ✓ |
| ±1.6 mbar to ±40 mbar ±160 Pa to ±4 kPa ±0.5 inH ₂ O to ±30 inH ₂ O | ✓ | ✓ | — | ✓ |
| Gage: | | | | |
| 60 mbar to 10 bar 6 kPa to 1 MPa 1 psi to 150 psi | ✓ | ✓ | ✓ | ✓ |
| 2.5 mbar to 40 mbar 250 Pa to 4 kPa 1 inH ₂ O to 30 inH ₂ O | ✓ | ✓ | — | ✓ |
| Temperature compensated | ✓ | ✓ | ✓ | — |
| Amplified | ✓ | ✓ | — | — |
| Output type: | | | | |
| analog | ✓ | ✓ | ✓ | ✓ |
| digital (SPI and I ² C) | ✓ | ✓ | — | — |
| Transfer function: | | | | |
| 10% to 90% of V _{supply} | ✓ | ✓ | — | — |
| Supply voltage: | | | | |
| 3.3 Vdc | ✓ | ✓ | — | — |
| 5.0 Vdc | ✓ | ✓ | — | — |
| 1.5 Vdc to 12.0 Vdc (for pressure ranges ≥60 mbar 6 kPa 1 psi) | — | — | ✓ | ✓ |
| 2.7 Vdc to 6.5 Vdc (for pressure ranges ≤40 mbar 4 kPa 20 inH ₂ O) | — | — | — | ✓ |
| Accuracy ≤ 0.25 %FSS BFSL | ✓ | ✓ | ✓ | ✓ |
| Compensated temperature range: | | | | |
| -20 °C to 85 °C [-4 °F to 185 °F] | — | ✓ | — | — |
| 0 °C to 85 °C [32 °F to 185 °F] | — | — | ✓ | — |
| 0 °C to 50 °C [32 °F to 122 °F] | ✓ | — | — | — |
| Operating temperature range: | | | | |
| -20 °C to 85 °C [-4 °F to 185 °F] | ✓ | — | — | — |
| -40 °C to 85 °C [-40 °F to 185 °F] | — | ✓ | ✓ | ✓ |
| Total Error Band:¹ | | | | |
| down to ±1% Full Scale Span max. | ✓ | — | — | — |
| down to ±2% Full Scale Span max. | — | ✓ | — | — |

¹Applies only to pressure ranges ≥16 mbar | 1.6 kPa | 5 inH₂O. For complete Total Error Band information, please see the specification tables in the HSC Series and the SSC Series published datasheets.

ADDITIONAL INFORMATION

The following associated literature is available at sensing.honeywell.com:

- Board Mount Pressure Sensors Line Guide
- Airflow, Force, and Pressure Sensors Product Range Guide
- Product Installation Instructions
- Product Nomenclature Tree and Order Guide
- Selection Guides
- Application-specific Information

⚠ WARNING **PERSONAL INJURY**

DO NOT USE these products as safety or emergency stop devices or in any other application where failure of the product could result in personal injury.

Failure to comply with these instructions could result in death or serious injury.

⚠ WARNING **MISUSE OF DOCUMENTATION**

- The information presented in this product sheet is for reference only. Do not use this document as a product installation guide.
- Complete installation, operation, and maintenance information is provided in the instructions supplied with each product.

Failure to comply with these instructions could result in death or serious injury.

Find out more

Honeywell serves its customers through a worldwide network of sales offices, representatives and distributors. For application assistance, current specifications, pricing or name of the nearest Authorized Distributor, contact your local sales office.

To learn more about Honeywell's sensing and control products, call **+1-815-235-6847** or **1-800-537-6945**, visit **sensing.honeywell.com**, or e-mail inquiries to **info.sc@honeywell.com**

Sensing and Control
Honeywell
1985 Douglas Drive North
Golden Valley, MN 55422
honeywell.com

WARRANTY/REMEDY

Honeywell warrants goods of its manufacture as being free of defective materials and faulty workmanship. Honeywell's standard product warranty applies unless agreed to otherwise by Honeywell in writing; please refer to your order acknowledgement or consult your local sales office for specific warranty details. If warranted goods are returned to Honeywell during the period of coverage, Honeywell will repair or replace, at its option, without charge those items it finds defective. **The foregoing is buyer's sole remedy and is in lieu of all other warranties, expressed or implied, including those of merchantability and fitness for a particular purpose. In no event shall Honeywell be liable for consequential, special, or indirect damages.**

While we provide application assistance personally, through our literature and the Honeywell website, it is up to the customer to determine the suitability of the product in the application.

Specifications may change without notice. The information we supply is believed to be accurate and reliable as of this printing. However, we assume no responsibility for its use.

Honeywell

Данный компонент на территории Российской Федерации

Вы можете приобрести в компании MosChip.

Для оперативного оформления запроса Вам необходимо перейти по данной ссылке:

<http://moschip.ru/get-element>

Вы можете разместить у нас заказ для любого Вашего проекта, будь то серийное производство или разработка единичного прибора.

В нашем ассортименте представлены ведущие мировые производители активных и пассивных электронных компонентов.

Нашей специализацией является поставка электронной компонентной базы двойного назначения, продукции таких производителей как XILINX, Intel (ex.ALTERA), Vicor, Microchip, Texas Instruments, Analog Devices, Mini-Circuits, Amphenol, Glenair.

Сотрудничество с глобальными дистрибьюторами электронных компонентов, предоставляет возможность заказывать и получать с международных складов практически любой перечень компонентов в оптимальные для Вас сроки.

На всех этапах разработки и производства наши партнеры могут получить квалифицированную поддержку опытных инженеров.

Система менеджмента качества компании отвечает требованиям в соответствии с ГОСТ Р ИСО 9001, ГОСТ РВ 0015-002 и ЭС РД 009

Офис по работе с юридическими лицами:

105318, г.Москва, ул.Щербаковская д.3, офис 1107, 1118, ДЦ «Щербаковский»

Телефон: +7 495 668-12-70 (многоканальный)

Факс: +7 495 668-12-70 (доб.304)

E-mail: info@moschip.ru

Skype отдела продаж:

moschip.ru

moschip.ru_4

moschip.ru_6

moschip.ru_9