

MC14051B, MC14052B, MC14053B



ON Semiconductor®

<http://onsemi.com>

Analog Multiplexers/Demultiplexers

The MC14051B, MC14052B, and MC14053B analog multiplexers are digitally-controlled analog switches. The MC14051B effectively implements an SP8T solid state switch, the MC14052B a DP4T, and the MC14053B a Triple SPDT. All three devices feature low ON impedance and very low OFF leakage current. Control of analog signals up to the complete supply voltage range can be achieved.

Features

- Triple Diode Protection on Control Inputs
- Switch Function is Break Before Make
- Supply Voltage Range = 3.0 Vdc to 18 Vdc
- Analog Voltage Range ($V_{DD} - V_{EE}$) = 3.0 to 18 V
Note: V_{EE} must be $\leq V_{SS}$
- Linearized Transfer Characteristics
- Low-noise – $12 \text{ nV}/\sqrt{\text{Cycle}}$, $f \geq 1.0 \text{ kHz}$ Typical
- Pin-for-Pin Replacement for CD4051, CD4052, and CD4053
- For 4PDT Switch, See MC14551B
- For Lower R_{ON} , Use the HC4051, HC4052, or HC4053 High-Speed CMOS Devices
- NLV Prefix for Automotive and Other Applications Requiring Unique Site and Control Change Requirements; AEC-Q100 Qualified and PPAP Capable
- These Devices are Pb-Free and are RoHS Compliant

MAXIMUM RATINGS (Voltages Referenced to V_{SS})

Symbol	Parameter	Value	Unit
V_{DD}	DC Supply Voltage Range (Referenced to V_{EE} , $V_{SS} \geq V_{EE}$)	-0.5 to +18.0	V
V_{in} , V_{out}	Input or Output Voltage Range (DC or Transient) (Referenced to V_{SS} for Control Inputs and V_{EE} for Switch I/O)	-0.5 to $V_{DD} + 0.5$	V
I_{in}	Input Current (DC or Transient) per Control Pin	+10	mA
I_{SW}	Switch Through Current	± 25	mA
P_D	Power Dissipation per Package (Note 1)	500	mW
T_A	Ambient Temperature Range	-55 to +125	°C
T_{stg}	Storage Temperature Range	-65 to +150	°C
T_L	Lead Temperature (8-Second Soldering)	260	°C

Stresses exceeding those listed in the Maximum Ratings table may damage the device. If any of these limits are exceeded, device functionality should not be assumed, damage may occur and reliability may be affected.

1. Temperature Derating: "D/DW" Packages: -7.0 mW/°C From 65°C To 125°C

This device contains protection circuitry to guard against damage due to high static voltages or electric fields. However, precautions must be taken to avoid applications of any voltage higher than maximum rated voltages to this high-impedance circuit. For proper operation, V_{in} and V_{out} should be constrained to the range $V_{SS} \leq (V_{in} \text{ or } V_{out}) \leq V_{DD}$.

Unused inputs must always be tied to an appropriate logic voltage level (e.g., either V_{SS} , V_{EE} or V_{DD}). Unused outputs must be left open.



1
SOIC-16
D SUFFIX
CASE 751B



1
TSSOP-16
DT SUFFIX
CASE 948F

MARKING DIAGRAMS

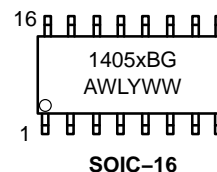

- x = 1, 2, or 3
- A = Assembly Location
- WL, L = Wafer Lot
- Y = Year
- WW, W = Work Week
- G or ■ = Pb-Free Package

(Note: Microdot may be in either location)

ORDERING INFORMATION

See detailed ordering and shipping information in the package dimensions section on page 9 of this data sheet.

MC14051B, MC14052B, MC14053B

MC14051B
8-Channel Analog
Multiplexer/Demultiplexer

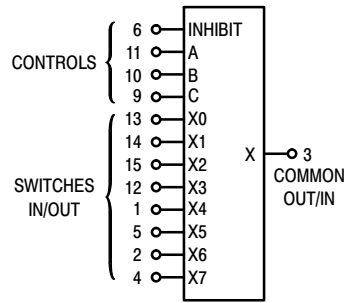

V_{DD} = PIN 16
 V_{SS} = PIN 8
 V_{EE} = PIN 7

MC14052B
Dual 4-Channel Analog
Multiplexer/Demultiplexer

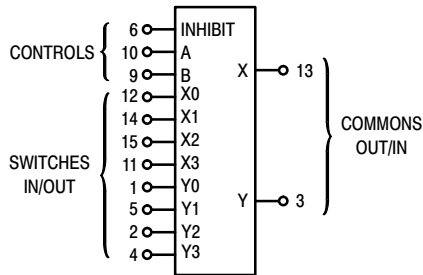

V_{DD} = PIN 16
 V_{SS} = PIN 8
 V_{EE} = PIN 7

MC14053B
Triple 2-Channel Analog
Multiplexer/Demultiplexer

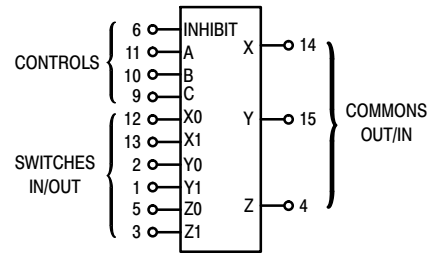

V_{DD} = PIN 16
 V_{SS} = PIN 8
 V_{EE} = PIN 7

Note: Control Inputs referenced to V_{SS} . Analog Inputs and Outputs reference to V_{EE} . V_{EE} must be $\leq V_{SS}$.

PIN ASSIGNMENT

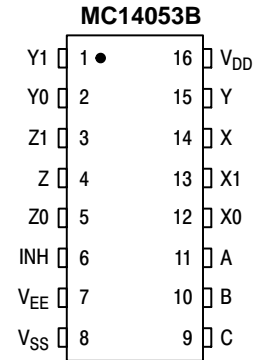
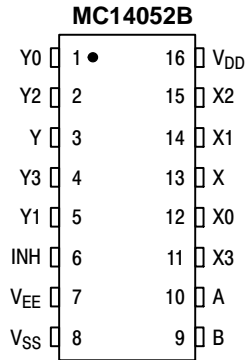
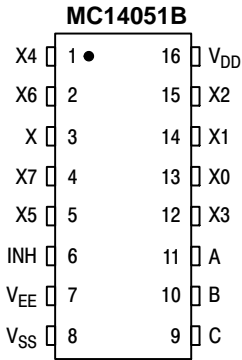

MC14051B, MC14052B, MC14053B

ELECTRICAL CHARACTERISTICS

Characteristic	Symbol	V _{DD}	Test Conditions	-55°C		25°C			125°C		Unit
				Min	Max	Min	Typ (Note 2)	Max	Min	Max	

SUPPLY REQUIREMENTS (Voltages Referenced to V_{EE})

Power Supply Voltage Range	V _{DD}	-	V _{DD} - 3.0 ≥ V _{SS} ≥ V _{EE}	3.0	18	3.0	-	18	3.0	18	V
Quiescent Current Per Package	I _{DD}	5.0 10 15	Control Inputs: V _{in} = V _{SS} or V _{DD} , Switch I/O: V _{EE} ≤ V _{I/O} ≤ V _{DD} , and ΔV _{switch} ≤ 500 mV (Note 3)	- - -	5.0 10 20	- - -	0.005 0.010 0.015	5.0 10 20	- - -	150 300 600	μA
Total Supply Current (Dynamic Plus Quiescent, Per Package)	I _{D(AV)}	5.0 10 15	T _A = 25°C only (The channel component, (V _{in} - V _{out})/R _{on} , is not included.)	Typical						(0.07 μA/kHz) f + I _{DD} (0.20 μA/kHz) f + I _{DD} (0.36 μA/kHz) f + I _{DD}	μA

CONTROL INPUTS — INHIBIT, A, B, C (Voltages Referenced to V_{SS})

Low-Level Input Voltage	V _{IL}	5.0 10 15	R _{on} = per spec, I _{off} = per spec	- - -	1.5 3.0 4.0	- - -	2.25 4.50 6.75	1.5 3.0 4.0	- - -	1.5 3.0 4.0	V
High-Level Input Voltage	V _{IH}	5.0 10 15	R _{on} = per spec, I _{off} = per spec	3.5 7.0 11	- - -	3.5 7.0 11	2.75 5.50 8.25	- - -	3.5 7.0 11	- - -	V
Input Leakage Current	I _{in}	15	V _{in} = 0 or V _{DD}	-	±0.1	-	±0.00001	±0.1	-	1.0	μA
Input Capacitance	C _{in}	-		-	-	-	5.0	7.5	-	-	pF

SWITCHES IN/OUT AND COMMONS OUT/IN — X, Y, Z (Voltages Referenced to V_{EE})

Recommended Peak-to-Peak Voltage Into or Out of the Switch	V _{I/O}	-	Channel On or Off	0	V _{DD}	0	-	V _{DD}	0	V _{DD}	V _{PP}
Recommended Static or Dynamic Voltage Across the Switch (Note 3) (Figure 5)	ΔV _{switch}	-	Channel On	0	600	0	-	600	0	300	mV
Output Offset Voltage	V _{OO}	-	V _{in} = 0 V, No Load	-	-	-	10	-	-	-	μV
ON Resistance	R _{on}	5.0 10 15	ΔV _{switch} ≤ 500 mV (Note 3) V _{in} = V _{IL} or V _{IH} (Control), and V _{in} = 0 to V _{DD} (Switch)	- - -	800 400 220	- - -	250 120 80	1050 500 280	- - -	1200 520 300	Ω
ΔON Resistance Between Any Two Channels in the Same Package	ΔR _{on}	5.0 10 15		- - -	70 50 45	- - -	25 10 10	70 50 45	- - -	135 95 65	Ω
Off-Channel Leakage Current (Figure 10)	I _{off}	15	V _{in} = V _{IL} or V _{IH} (Control) Channel to Channel or Any One Channel	-	±100	-	±0.05	±100	-	±1000	nA
Capacitance, Switch I/O	C _{I/O}	-	Inhibit = V _{DD}	-	-	-	10	-	-	-	pF
Capacitance, Common O/I	C _{O/I}	-	Inhibit = V _{DD} (MC14051B) (MC14052B) (MC14053B)	- - -	- - -	- - -	60 32 17	- - -	- - -	- - -	pF
Capacitance, Feedthrough (Channel Off)	C _{I/O}	- -	Pins Not Adjacent Pins Adjacent	- -	- -	- -	0.15 0.47	- -	- -	- -	pF

Product parametric performance is indicated in the Electrical Characteristics for the listed test conditions, unless otherwise noted. Product performance may not be indicated by the Electrical Characteristics if operated under different conditions.

2. Data labeled "Typ" is not to be used for design purposes, but is intended as an indication of the IC's potential performance.

3. For voltage drops across the switch (ΔV_{switch}) > 600 mV (> 300 mV at high temperature), excessive V_{DD} current may be drawn, i.e. the current out of the switch may contain both V_{DD} and switch input components. The reliability of the device will be unaffected unless the Maximum Ratings are exceeded. (See first page of this data sheet.)

MC14051B, MC14052B, MC14053B

ELECTRICAL CHARACTERISTICS (Note 4) ($C_L = 50 \text{ pF}$, $T_A = 25^\circ\text{C}$) ($V_{EE} \leq V_{SS}$ unless otherwise indicated)

Characteristic	Symbol	$V_{DD} - V_{EE}$ Vdc	Typ (Note 5) All Types	Max	Unit
Propagation Delay Times (Figure 6) Switch Input to Switch Output ($R_L = 1 \text{ k}\Omega$) MC14051 $t_{PLH}, t_{PHL} = (0.17 \text{ ns/pF}) C_L + 26.5 \text{ ns}$ $t_{PLH}, t_{PHL} = (0.08 \text{ ns/pF}) C_L + 11 \text{ ns}$ $t_{PLH}, t_{PHL} = (0.06 \text{ ns/pF}) C_L + 9.0 \text{ ns}$ MC14052 $t_{PLH}, t_{PHL} = (0.17 \text{ ns/pF}) C_L + 21.5 \text{ ns}$ $t_{PLH}, t_{PHL} = (0.08 \text{ ns/pF}) C_L + 8.0 \text{ ns}$ $t_{PLH}, t_{PHL} = (0.06 \text{ ns/pF}) C_L + 7.0 \text{ ns}$ MC14053 $t_{PLH}, t_{PHL} = (0.17 \text{ ns/pF}) C_L + 16.5 \text{ ns}$ $t_{PLH}, t_{PHL} = (0.08 \text{ ns/pF}) C_L + 4.0 \text{ ns}$ $t_{PLH}, t_{PHL} = (0.06 \text{ ns/pF}) C_L + 3.0 \text{ ns}$	t_{PLH}, t_{PHL}	5.0 10 15	35 15 12	90 40 30	ns
Inhibit to Output ($R_L = 10 \text{ k}\Omega$, $V_{EE} = V_{SS}$) Output "1" or "0" to High Impedance, or High Impedance to "1" or "0" Level MC14051B	$t_{PHZ}, t_{PLZ},$ t_{PZH}, t_{PZL}	5.0 10 15	350 170 140	700 340 280	ns
MC14052B		5.0 10 15	300 155 125	600 310 250	ns
MC14053B		5.0 10 15	275 140 110	550 280 220	ns
Control Input to Output ($R_L = 1 \text{ k}\Omega$, $V_{EE} = V_{SS}$) MC14051B	t_{PLH}, t_{PHL}	5.0 10 15	360 160 120	720 320 240	ns
MC14052B		5.0 10 15	325 130 90	650 260 180	ns
MC14053B		5.0 10 15	300 120 80	600 240 160	ns
Second Harmonic Distortion ($R_L = 10 \text{ k}\Omega$, $f = 1 \text{ kHz}$) $V_{in} = 5 \text{ V}_{PP}$	–	10	0.07	–	%
Bandwidth (Figure 7) ($R_L = 50 \Omega$, $V_{in} = 1/2 (V_{DD} - V_{EE})$ p-p, $C_L = 50 \text{ pF}$ $20 \text{ Log } (V_{out}/V_{in}) = -3 \text{ dB}$)	BW	10	17	–	MHz
Off Channel Feedthrough Attenuation (Figure 7) $R_L = 1 \text{ k}\Omega$, $V_{in} = 1/2 (V_{DD} - V_{EE})$ p-p $f_{in} = 4.5 \text{ MHz}$ — MC14051B $f_{in} = 30 \text{ MHz}$ — MC14052B $f_{in} = 55 \text{ MHz}$ — MC14053B	–	10	–50	–	dB
Channel Separation (Figure 8) ($R_L = 1 \text{ k}\Omega$, $V_{in} = 1/2 (V_{DD} - V_{EE})$ p-p, $f_{in} = 3.0 \text{ MHz}$)	–	10	–50	–	dB
Crosstalk, Control Input to Common O/I (Figure 9) ($R_1 = 1 \text{ k}\Omega$, $R_L = 10 \text{ k}\Omega$ Control $t_{TLH} = t_{THL} = 20 \text{ ns}$, Inhibit = V_{SS})	–	10	75	–	mV

Product parametric performance is indicated in the Electrical Characteristics for the listed test conditions, unless otherwise noted. Product performance may not be indicated by the Electrical Characteristics if operated under different conditions.

4. The formulas given are for the typical characteristics only at 25°C .

5. Data labelled "Typ" is not to be used for design purposes but is intended as an indication of the IC's potential performance.

MC14051B, MC14052B, MC14053B



Figure 1. Switch Circuit Schematic

TRUTH TABLE

Control Inputs			ON Switches		
Inhibit	Select		MC14051B	MC14052B	MC14053B
	C*	B A			
0	0	0 0	X0	Y0 X0	Z0 Y0 X0
0	0	0 1	X1	Y1 X1	Z0 Y0 X1
0	0	1 0	X2	Y2 X2	Z0 Y1 X0
0	0	1 1	X3	Y3 X3	Z0 Y1 X1
0	1	0 0	X4		Z1 Y0 X0
0	1	0 1	X5		Z1 Y0 X1
0	1	1 0	X6		Z1 Y1 X0
0	1	1 1	X7		Z1 Y1 X1
1	x	x x	None	None	None

*Not applicable for MC14052
x = Don't Care



Figure 2. MC14051B Functional Diagram



Figure 3. MC14052B Functional Diagram



Figure 4. MC14053B Functional Diagram

TEST CIRCUITS



Figure 5. ΔV Across Switch

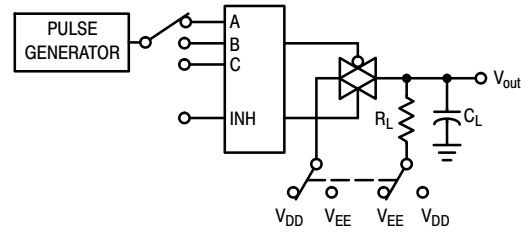

Figure 6. Propagation Delay Times, Control and Inhibit to Output

A, B, and C inputs used to turn ON or OFF the switch under test.



Figure 7. Bandwidth and Off-Channel Feedthrough Attenuation



Figure 8. Channel Separation (Adjacent Channels Used For Setup)



Figure 9. Crosstalk, Control Input to Common O/I



Figure 10. Off Channel Leakage

NOTE: See also Figures 7 and 8 in the MC14016B data sheet.

MC14051B, MC14052B, MC14053B



Figure 11. Channel Resistance (R_{ON}) Test Circuit

TYPICAL RESISTANCE CHARACTERISTICS



Figure 12. $V_{DD} = 7.5\text{ V}$, $V_{EE} = -7.5\text{ V}$

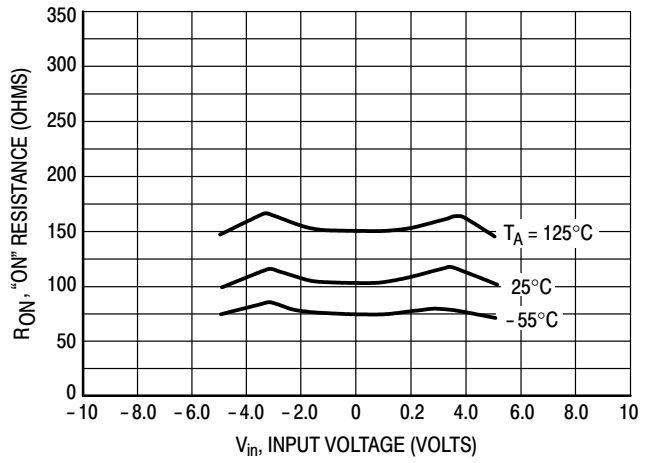

Figure 13. $V_{DD} = 5.0\text{ V}$, $V_{EE} = -5.0\text{ V}$



Figure 14. $V_{DD} = 2.5\text{ V}$, $V_{EE} = -2.5\text{ V}$

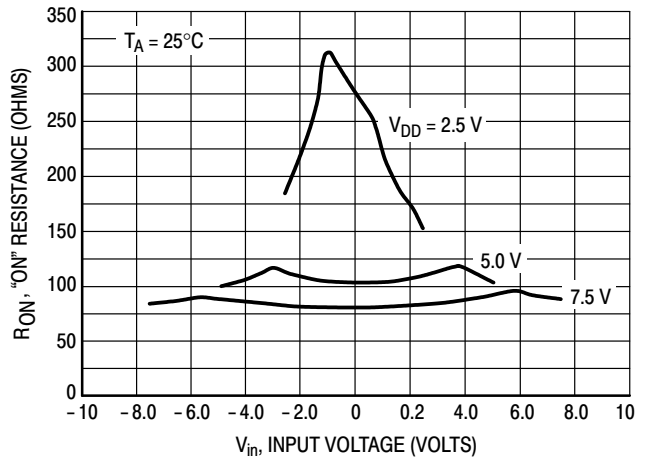

Figure 15. Comparison at 25°C , $V_{DD} = -V_{EE}$

APPLICATIONS INFORMATION

Figure A illustrates use of the on-chip level converter detailed in Figures 2, 3, and 4. The 0-to-5 V Digital Control signal is used to directly control a 9 V_{p-p} analog signal.

The digital control logic levels are determined by V_{DD} and V_{SS}. The V_{DD} voltage is the logic high voltage; the V_{SS} voltage is logic low. For the example, V_{DD} = +5 V = logic high at the control inputs; V_{SS} = GND = 0 V = logic low.

The maximum analog signal level is determined by V_{DD} and V_{EE}. The V_{DD} voltage determines the maximum recommended peak above V_{SS}. The V_{EE} voltage determines the maximum swing below V_{SS}. For the example, V_{DD} - V_{SS} = 5 V maximum swing above V_{SS}; V_{SS} - V_{EE} = 5 V maximum swing below V_{SS}. The example shows a ±4.5 V signal which allows a 1/2 volt margin at each

peak. If voltage transients above V_{DD} and/or below V_{EE} are anticipated on the analog channels, external diodes (D_X) are recommended as shown in Figure B. These diodes should be small signal types able to absorb the maximum anticipated current surges during clipping.

The *absolute* maximum potential difference between V_{DD} and V_{EE} is 18.0 V. Most parameters are specified up to 15 V which is the *recommended* maximum difference between V_{DD} and V_{EE}.

Balanced supplies are not required. However, V_{SS} must be greater than or equal to V_{EE}. For example, V_{DD} = +10 V, V_{SS} = +5 V, and V_{EE} = -3 V is acceptable. See the Table below.



Figure A. Application Example

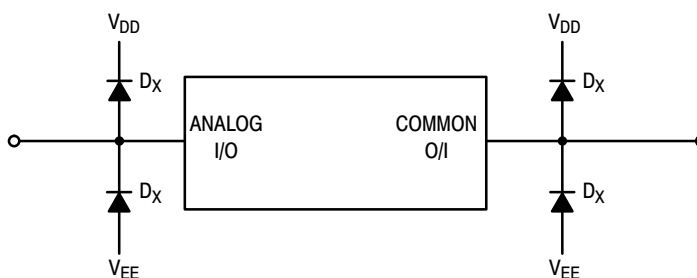

Figure B. External Germanium or Schottky Clipping Diodes

POSSIBLE SUPPLY CONNECTIONS

V _{DD} In Volts	V _{SS} In Volts	V _{EE} In Volts	Control Inputs Logic High/Logic Low In Volts	Maximum Analog Signal Range In Volts
+8	0	-8	+8/0	+8 to -8 = 16 V _{p-p}
+5	0	-12	+5/0	+5 to -12 = 17 V _{p-p}
+5	0	0	+5/0	+5 to 0 = 5 V _{p-p}
+5	0	-5	+5/0	+5 to -5 = 10 V _{p-p}
+10	+5	-5	+10/+5	+10 to -5 = 15 V _{p-p}

MC14051B, MC14052B, MC14053B

ORDERING INFORMATION

Device	Package	Shipping†
MC14051BDG	SOIC-16 (Pb-Free)	48 Units / Rail
NLV14051BDG*	SOIC-16 (Pb-Free)	48 Units / Rail
MC14051BDR2G	SOIC-16 (Pb-Free)	2500 / Tape & Reel
NLV14051BDR2G*	SOIC-16 (Pb-Free)	2500 / Tape & Reel
MC14051BDTR2G	TSSOP-16 (Pb-Free)	2500 / Tape & Reel
NLV14051BDTR2G*	TSSOP-16 (Pb-Free)	2500 / Tape & Reel

MC14052BDG	SOIC-16 (Pb-Free)	48 Units / Rail
NLV14052BDG*	SOIC-16 (Pb-Free)	48 Units / Rail
MC14052BDR2G	SOIC-16 (Pb-Free)	2500 / Tape & Reel
NLV14052BDR2G*	SOIC-16 (Pb-Free)	2500 / Tape & Reel
MC14052BDTR2G	TSSOP-16 (Pb-Free)	2500 / Tape & Reel
NLV14052BDTR2G*	TSSOP-16 (Pb-Free)	2500 / Tape & Reel

MC14053BDG	SOIC-16 (Pb-Free)	48 Units / Rail
NLV14053BDG*	SOIC-16 (Pb-Free)	48 Units / Rail
MC14053BDR2G	SOIC-16 (Pb-Free)	2500 / Tape & Reel
NLV14053BDR2G*	SOIC-16 (Pb-Free)	2500 / Tape & Reel
MC14053BDTR2G	TSSOP-16 (Pb-Free)	2500 / Tape & Reel
NLV14053BDTR2G*	TSSOP-16 (Pb-Free)	2500 / Tape & Reel

†For information on tape and reel specifications, including part orientation and tape sizes, please refer to our Tape and Reel Packaging Specifications Brochure, BRD8011/D.

*NLV Prefix for Automotive and Other Applications Requiring Unique Site and Control Change Requirements; AEC-Q100 Qualified and PPAP Capable.

MC14051B, MC14052B, MC14053B

PACKAGE DIMENSIONS

TSSOP-16
DT SUFFIX
CASE 948F
ISSUE B

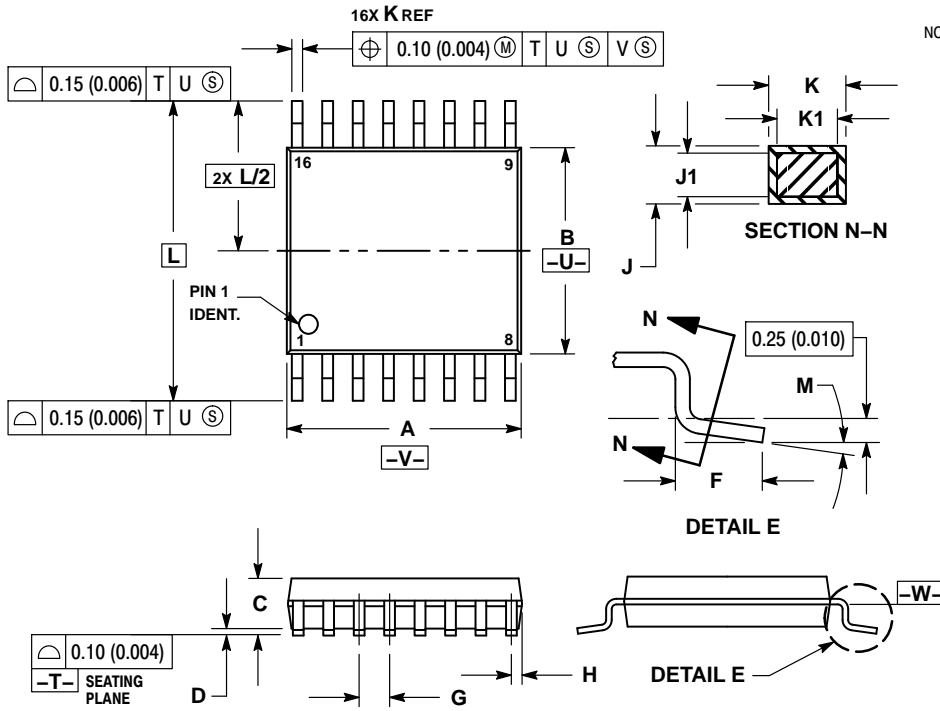

NOTES:

1. DIMENSIONING AND TOLERANCING PER ANSI Y14.5M, 1982.
2. CONTROLLING DIMENSION: MILLIMETER.
3. DIMENSION A DOES NOT INCLUDE MOLD FLASH, PROTRUSIONS OR GATE BURRS. MOLD FLASH OR GATE BURRS SHALL NOT EXCEED 0.15 (0.006) PER SIDE.
4. DIMENSION B DOES NOT INCLUDE INTERLEAD FLASH OR PROTRUSION. INTERLEAD FLASH OR PROTRUSION SHALL NOT EXCEED 0.25 (0.010) PER SIDE.
5. DIMENSION K DOES NOT INCLUDE DAMBAR PROTRUSION. ALLOWABLE DAMBAR PROTRUSION SHALL BE 0.08 (0.003) TOTAL IN EXCESS OF THE K DIMENSION AT MAXIMUM MATERIAL CONDITION.
6. TERMINAL NUMBERS ARE SHOWN FOR REFERENCE ONLY.
7. DIMENSION A AND B ARE TO BE DETERMINED AT DATUM PLANE -W-.

DIM	MILLIMETERS		INCHES	
	MIN	MAX	MIN	MAX
A	4.90	5.10	0.193	0.200
B	4.30	4.50	0.169	0.177
C	---	1.20	---	0.047
D	0.05	0.15	0.002	0.006
F	0.50	0.75	0.020	0.030
G	0.65 BSC		0.026 BSC	
H	0.18	0.28	0.007	0.011
J	0.09	0.20	0.004	0.008
J1	0.09	0.16	0.004	0.006
K	0.19	0.30	0.007	0.012
K1	0.19	0.25	0.007	0.010
L	6.40 BSC		0.252 BSC	
M	0°	8°	0°	8°

SOLDERING FOOTPRINT*

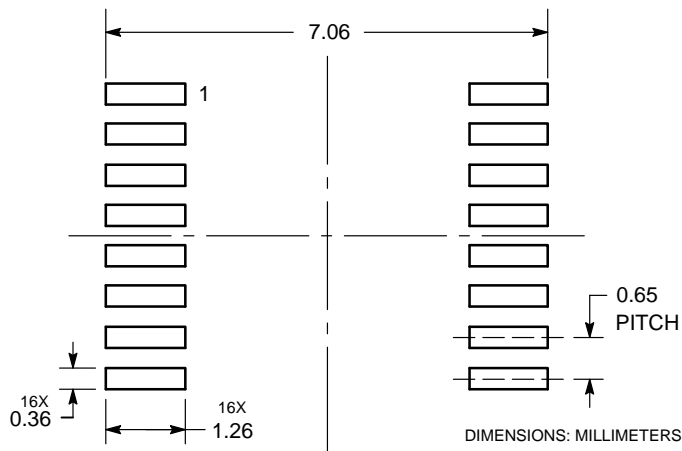

*For additional information on our Pb-Free strategy and soldering details, please download the ON Semiconductor Soldering and Mounting Techniques Reference Manual, SOLDERRM/D.

MC14051B, MC14052B, MC14053B

PACKAGE DIMENSIONS

SOIC-16
D SUFFIX
CASE 751B-05
ISSUE K



NOTES:

1. DIMENSIONING AND TOLERANCING PER ANSI Y14.5M, 1982.
2. CONTROLLING DIMENSION: MILLIMETER.
3. DIMENSIONS A AND B DO NOT INCLUDE MOLD PROTRUSION.
4. MAXIMUM MOLD PROTRUSION 0.15 (0.006) PER SIDE.
5. DIMENSION D DOES NOT INCLUDE DAMBAR PROTRUSION. ALLOWABLE DAMBAR PROTRUSION SHALL BE 0.127 (0.005) TOTAL IN EXCESS OF THE D DIMENSION AT MAXIMUM MATERIAL CONDITION.

DIM	MILLIMETERS		INCHES	
	MIN	MAX	MIN	MAX
A	9.80	10.00	0.386	0.393
B	3.80	4.00	0.150	0.157
C	1.35	1.75	0.054	0.068
D	0.35	0.49	0.014	0.019
F	0.40	1.25	0.016	0.049
G	1.27 BSC		0.050 BSC	
J	0.19	0.25	0.008	0.009
K	0.10	0.25	0.004	0.009
M	0°	7°	0°	7°
P	5.80	6.20	0.229	0.244
R	0.25	0.50	0.010	0.019

SOLDERING FOOTPRINT*

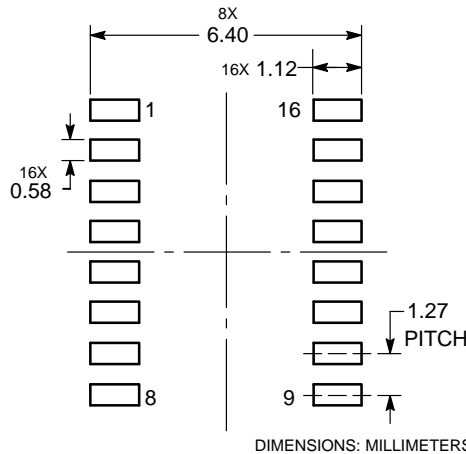

*For additional information on our Pb-Free strategy and soldering details, please download the ON Semiconductor Soldering and Mounting Techniques Reference Manual, SOLDERRM/D.

ON Semiconductor and the  are registered trademarks of Semiconductor Components Industries, LLC (SCILLC) or its subsidiaries in the United States and/or other countries. SCILLC owns the rights to a number of patents, trademarks, copyrights, trade secrets, and other intellectual property. A listing of SCILLC's product/patent coverage may be accessed at www.onsemi.com/site/pdf/Patent-Marking.pdf. SCILLC reserves the right to make changes without further notice to any products herein. SCILLC makes no warranty, representation or guarantee regarding the suitability of its products for any particular purpose, nor does SCILLC assume any liability arising out of the application or use of any product or circuit, and specifically disclaims any and all liability, including without limitation special, consequential or incidental damages. "Typical" parameters which may be provided in SCILLC data sheets and/or specifications can and do vary in different applications and actual performance may vary over time. All operating parameters, including "Typicals" must be validated for each customer application by customer's technical experts. SCILLC does not convey any license under its patent rights nor the rights of others. SCILLC products are not designed, intended, or authorized for use as components in systems intended for surgical implant into the body, or other applications intended to support or sustain life, or for any other application in which the failure of the SCILLC product could create a situation where personal injury or death may occur. Should Buyer purchase or use SCILLC products for any such unintended or unauthorized application, Buyer shall indemnify and hold SCILLC and its officers, employees, subsidiaries, affiliates, and distributors harmless against all claims, costs, damages, and expenses, and reasonable attorney fees arising out of, directly or indirectly, any claim of personal injury or death associated with such unintended or unauthorized use, even if such claim alleges that SCILLC was negligent regarding the design or manufacture of the part. SCILLC is an Equal Opportunity/Affirmative Action Employer. This literature is subject to all applicable copyright laws and is not for resale in any manner.

PUBLICATION ORDERING INFORMATION

LITERATURE FULFILLMENT:

Literature Distribution Center for ON Semiconductor
P.O. Box 5163, Denver, Colorado 80217 USA
Phone: 303-675-2175 or 800-344-3860 Toll Free USA/Canada
Fax: 303-675-2176 or 800-344-3867 Toll Free USA/Canada
Email: orderlit@onsemi.com

N. American Technical Support: 800-282-9855 Toll Free
USA/Canada
Europe, Middle East and Africa Technical Support:
Phone: 421 33 790 2910
Japan Customer Focus Center
Phone: 81-3-5817-1050

ON Semiconductor Website: www.onsemi.com

Order Literature: <http://www.onsemi.com/orderlit>

For additional information, please contact your local Sales Representative

Данный компонент на территории Российской Федерации

Вы можете приобрести в компании MosChip.

Для оперативного оформления запроса Вам необходимо перейти по данной ссылке:

<http://moschip.ru/get-element>

Вы можете разместить у нас заказ для любого Вашего проекта, будь то серийное производство или разработка единичного прибора.

В нашем ассортименте представлены ведущие мировые производители активных и пассивных электронных компонентов.

Нашей специализацией является поставка электронной компонентной базы двойного назначения, продукции таких производителей как XILINX, Intel (ex.ALTERA), Vicor, Microchip, Texas Instruments, Analog Devices, Mini-Circuits, Amphenol, Glenair.

Сотрудничество с глобальными дистрибьюторами электронных компонентов, предоставляет возможность заказывать и получать с международных складов практически любой перечень компонентов в оптимальные для Вас сроки.

На всех этапах разработки и производства наши партнеры могут получить квалифицированную поддержку опытных инженеров.

Система менеджмента качества компании отвечает требованиям в соответствии с ГОСТ Р ИСО 9001, ГОСТ РВ 0015-002 и ЭС РД 009

Офис по работе с юридическими лицами:

105318, г.Москва, ул.Щербаковская д.3, офис 1107, 1118, ДЦ «Щербаковский»

Телефон: +7 495 668-12-70 (многоканальный)

Факс: +7 495 668-12-70 (доб.304)

E-mail: info@moschip.ru

Skype отдела продаж:

moschip.ru

moschip.ru_4

moschip.ru_6

moschip.ru_9