

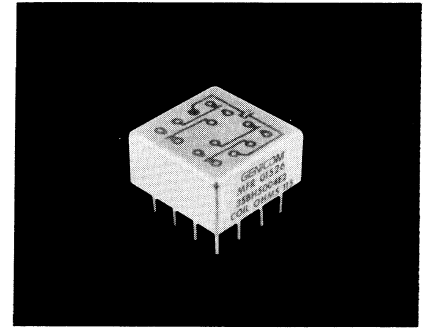

# 150 Grid-space Micro-miniature Relays



A

## Type 3SBH (4PDT)

### Features

- Low profile... only 0.32 inch high
- Long life version available
- MIL-R-39016/14

### Description

This 150 four pole double throw Grid-space relay is the companion to the two pole 3SBC type shown on page 10. It also features the same .150 inch pin spacing that allows you to insert the relay with no intermediate pin spreaders. There is adequate clearance for conductors to reach all pins. It is a very compact 4 pole double throw 2 ampere relay.

## Other Specifications

### Contact Ratings:

DC resistive—2 amps at 28 volts  
 DC inductive—0.5 amps at 28 volts, 200 mH  
 AC resistive—0.5 amps at 115 volts, 400 or 60 Hz (enclosure isolated from ground, or enclosure and movable contact at same potential)  
 AC 0.125 amps at 115 volts (enclosure at line potential with respect to movable contact)  
 Low level—low-level operation at 50 millivolts, 30 microamps, 33-ohm miss level

### Contact Resistance:

0.050 ohms max.; 0.150 ohms after life test

### Life:

100,000 operations at rated loads listed; 1,000,000, operations at low-level loads

### Operate Time:

4 ms max.

### Release Time:

4 ms max.

### Bounce:

1.5 millisecond

### Dielectric Strength:

500 volts rms at sea level; 350 volts rms at 70,000 feet

### Insulation Resistance:

1,000 megohms minimum over temperature range

### Vibration:

30G, to 3000 Hz

### Shock:

100G at 11 ms

### Temperature:

– 65C to +125C

See page 19 for Mounting Forms, Terminals and Circuit Diagrams.

F B

Coil Table (All Values DC)\* Type 3SBH, 4 Pole Relay — 250 mW Sensitivity: (Code 1)

| SENSITIVITY CODE: 1 |                             |                             |                              |                              |      |
|---------------------|-----------------------------|-----------------------------|------------------------------|------------------------------|------|
| Coil Code Letter    | Coil Resistance at 25C ohms | Voltage Calibrated, Code: 5 |                              |                              |      |
|                     |                             | Suggested Source Volts†     | Maximum Operate Volts at 25C | Release Voltage Range at 25C |      |
|                     |                             |                             |                              | Max.                         | Min. |
| B                   | 28 ± 10%                    | 4.0- 7.0                    | 2.7                          | 1.6                          | 0.3  |
| D                   | 73 ± 10%                    | 6.0-11.0                    | 4.2                          | 2.5                          | 0.4  |
| E                   | 115 ± 10%                   | 8.0-14.0                    | 5.4                          | 3.2                          | 0.6  |
| G                   | 280 ± 10%                   | 12 -22.0                    | 8.4                          | 5.0                          | 0.8  |
| H                   | 430 ± 10%                   | 15 -26.0                    | 10.3                         | 6.0                          | 1.0  |
| K                   | 720 ± 10%                   | 20 -35.0                    | 13.5                         | 8.1                          | 1.5  |
| N                   | 1040 ± 10%                  | 26 -46.0                    | 17.5                         | 10.5                         | 1.9  |

\* Values listed are Factory test and inspection values. User should allow for meter variations. † Applicable over the operating temperature range in circulating air.

E

## ORDERING INSTRUCTIONS

**Catalog-selected Relays:** The catalog number is derived by choosing the proper CODE for each of the six relay characteristics in the order in which the codes are listed. Use the location guide (letters in vertical red columns) to find each CODE easily.

**Example:** The relay selected in this example is a 4PDT 150-grid relay, voltage calibrated end bracket mounting, 0.13-inch solder hook header, 720 ohms coil resistance, and 250 mW sensitivity. By choosing the proper code for each of these relay characteristics, the catalog number is identified as 35BH5131K5. The letter R following sensitivity code indicates relay received 5000 operation miss-test. Ex. 35BH5131K5R

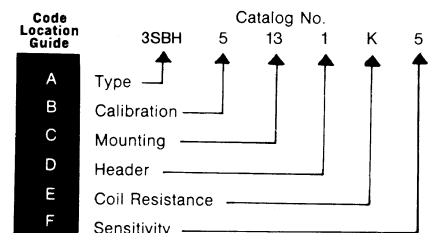

# 150 Grid-space Hybrid Micro-miniature Relays

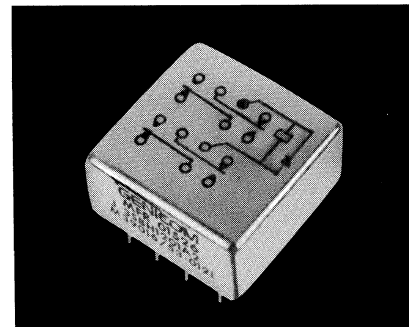

## Type 3SBH (4PDT)

### Features

- Low profile... only 0.32 inch high
- Long life version available
- MIL-R-39016/53 & 54

### Description

The 4PDT .150 Grid-space hybrid relays are advanced designs of the standard high reliability 4PDT .150 Grid-space relays. In the single diode version, the relay coil-back electromotive force is suppressed to prevent circuit/component damage. With the dual diode version, a steering diode is added to the coil circuit, along with the suppression diode. This steering diode prevents operation of the relay by reverse polarity voltages and protects the suppression diode. The single diode version is qualified to MIL-R-39016/53 and the dual diode is qualified to MIL-R-39016/54.

## Other Specifications

### Contact Ratings:

DC resistive—2 amps at 28 volts  
 DC inductive—0.5 amps at 28 volts, 200 mH  
 AC resistive—0.5 amps at 115 volts, 400 or 60 Hz (enclosure isolated from ground, or enclosure and movable contact at same potential)  
 AC 0.125 amps at 115 volts (enclosure at line potential with respect to movable contact)  
 Low-level—50  $\mu$ A at 50 mV  
 Peak AC or DC

### Contact Resistance:

0.050 ohms max.;  
 0.150 ohms after life test

### Life:

100,000 operations at rated loads listed;  
 1,000,000, operations at low-level loads

### Operate Time:

4 ms max.

### Release Time:

6 ms max.

### Bounce:

2.0 millisecond

### Dielectric Strength: Note (1)

500 volts rms at sea level;  
 350 volts rms at 70,000 feet

### Insulation Resistance: Note (1)

1,000 megohms minimum over temperature range

## Semiconductor Characteristics at 25C:

Max. Negative Transient: 1 volt  
 Breakdown voltage: 100VDC @ 10  $\mu$  A Minimum  
 Max. Leakage Current: 1 microamp @ 50VDC

**Note (1):** Tests for dielectric withstanding voltage and insulation resistance should be made with "coil terminals" shorted together to avoid unnecessary electrical stress to semiconductor elements.

See page 19 for Mounting Forms, Terminals and Circuit Diagrams.

Coil Table (All Values DC)\* Type 3SBH, 4 Pole Relay — 250 mW Sensitivity: (Code 5 single diode, Code 6 dual diodes)

| Single Diode     |                             | SENSITIVITY CODE: 5         |                              |                              |      |
|------------------|-----------------------------|-----------------------------|------------------------------|------------------------------|------|
| Coil Code Letter | Coil Resistance at 25C ohms | Voltage Calibrated, Code: 5 |                              |                              |      |
|                  |                             | Suggested Source Volts†     | Maximum Operate Volts at 25C | Release Voltage Range at 25C |      |
|                  |                             |                             |                              | Max.                         | Min. |
| B                | 28 $\pm$ 10%                | 4.0- 7.0                    | 2.7                          | 1.6                          | 0.3  |
| D                | 73 $\pm$ 10%                | 6.0-11.0                    | 4.2                          | 2.5                          | 0.4  |
| E                | 115 $\pm$ 10%               | 8.0-14.0                    | 5.4                          | 3.2                          | 0.6  |
| G                | 280 $\pm$ 10%               | 12 -22.0                    | 8.4                          | 5.0                          | 0.8  |
| H                | 430 $\pm$ 10%               | 15 -26.0                    | 10.3                         | 6.0                          | 1.0  |
| K                | 720 $\pm$ 10%               | 20 -35.0                    | 13.5                         | 8.1                          | 1.5  |
| N                | 1040 $\pm$ 10%              | 26 -46.0                    | 17.5                         | 10.5                         | 1.9  |
| Dual Diode       |                             | SENSITIVITY CODE: 6         |                              |                              |      |
| B                | 28 $\pm$ 10%                | 4.0- 7.0                    | 3.7                          | 2.3                          | 0.5  |
| D                | 73 $\pm$ 10%                | 6.0-11.0                    | 5.2                          | 3.2                          | 0.6  |
| E                | 115 $\pm$ 10%               | 8.0-14.0                    | 6.4                          | 3.9                          | 0.8  |
| G                | 280 $\pm$ 10%               | 12.0-22.0                   | 9.4                          | 5.7                          | 1.0  |
| H                | 430 $\pm$ 10%               | 15 -26.0                    | 11.3                         | 6.7                          | 1.2  |
| K                | 720 $\pm$ 10%               | 20 -35.0                    | 14.5                         | 8.8                          | 1.7  |
| N                | 1040 $\pm$ 10%              | 26 -46.0                    | 18.1                         | 11.1                         | 2.1  |

\*Values listed are factory test and inspection values. User should allow for meter variations.

†Applicable over the operating temperature range in circulating air.



# Long-life 150 Grid-space Micro-miniature Relays

## 100,000,000 Operations At Low Levels

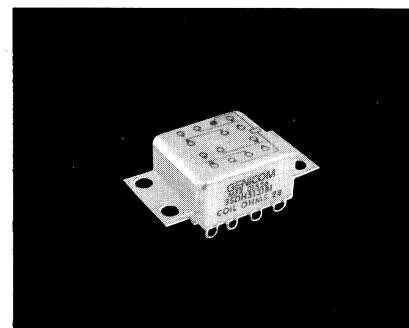

A

### Type 3SDH (4PDT)

#### Features

- Long life at low level or signal loads.
- Low profile... only 0.32 inch high

#### Description

The 3SDH relay is designed for 100,000,000 operations at low levels. It is a four pole double throw Grid-spaced relay. The 0.150 inch pin spacing allows the user to insert the relay with no intermediate pin spreaders. There is adequate clearance for conductor to reach all pins.

### Other Specifications

#### Contact Ratings:

DC resistive—2 amps at 28 volts,  
(DC 100,000 operations)  
DC inductive—0.3 amp at 28 volts,  
(L/R not greater than 0.008)  
AC resistive—0.5 amp at 115 volts, 400  
or 60 Hz (enclosure isolated from  
ground, or enclosure and movable con-  
tact at same potential)  
AC resistive 0.125 amps at 115 volts  
(enclosure at line potential with respect  
to movable contact)  
Low-level—50  $\mu$ A at 50 mV  
Peak AC or DC

#### Contact Resistance:

0.050 ohms max.; 0.150 ohms after life  
tests

#### Life:

100,000 operations at rated loads lifted;  
100,000,000 operations @ low-level loads

**Operate Time:** @ +25°C  
4 ms max.

**Release Time:** @ + 25°C  
4 ms max.

**Bounce:** @ +25°C  
1.5 millisecond

**Dielectric Strength:**  
500 volts rms at sea level;  
350 volts rms at 70,000 feet

**Insulation Resistance:**  
1,000 megohms minimum over  
temperature range

**Vibration:**  
30G, to 3000 Hz

**Shock:**  
100G at 11 ms

**Temperature:**  
– 40C to +125C

See page 19 for Mounting Forms,  
Terminals and Circuit Diagrams.

F

B

E

**Coil Table (All Values DC)\*Type 3SDH, 4 Pole Relay—210mW Sensitivity: (Code 1)**

| SENSITIVITY CODE: 1    |                                   |                               |                                    |                                 |      |
|------------------------|-----------------------------------|-------------------------------|------------------------------------|---------------------------------|------|
| Coil<br>Code<br>Letter | Coil<br>Resistance<br>at 25C ohms | Voltage Calibrated, Code: 5   |                                    |                                 |      |
|                        |                                   | Suggested<br>Source<br>Volts† | Maximum<br>Operate<br>Volts at 25C | Release Voltage<br>Range at 25C |      |
|                        |                                   |                               |                                    | Max.                            | Min. |
| B                      | 28 $\pm$ 10%                      | 4.0- 7.0                      | 3.0                                | 1.6                             | 0.3  |
| D                      | 73 $\pm$ 10%                      | 6.0-11.0                      | 4.8                                | 2.5                             | 0.4  |
| E                      | 115 $\pm$ 10%                     | 8.0-14.0                      | 5.9                                | 3.2                             | 0.6  |
| G                      | 280 $\pm$ 10%                     | 12 -22.0                      | 9.3                                | 5.0                             | 0.8  |
| H                      | 430 $\pm$ 10%                     | 15 -26.0                      | 11.5                               | 6.0                             | 1.0  |
| K                      | 720 $\pm$ 10%                     | 20 -35.0                      | 14.9                               | 8.1                             | 1.5  |
| N                      | 1040 $\pm$ 10%                    | 26 -46.0                      | 17.9                               | 10.5                            | 1.9  |

\* Values listed are Factory test and inspection values. User should allow for meter variations. † Applicable over the operating temperature range in circulating air.

# Mounting Forms (3SBH, 3SDH)

(Vibration note with each form is acceleration from 55 to 3000 Hz)

### No Mount

| Mounting Code | Vibration* |
|---------------|------------|
| 00            | 30g        |

\*Assumes relay held securely by potting or other means.

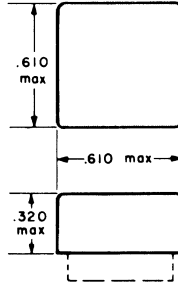

### End Bracket

| Mounting Code | Vibration |
|---------------|-----------|
| 13            | 30g       |

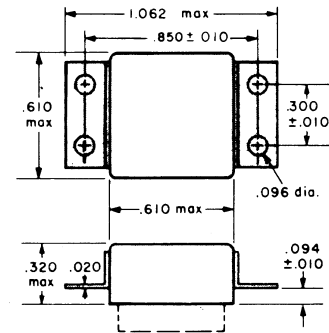

## Header Types

| Type                            | Z Dimension | Header Code |
|---------------------------------|-------------|-------------|
| Solder hook                     | 0.13        | 1           |
| Straight pin                    | 0.12        | 8           |
| Straight pin socket or PCB type | 0.19        | 4           |
| Straight pin                    | 0.25        | 5           |

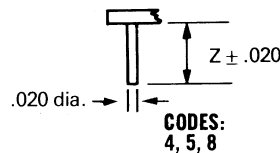
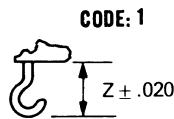

All dimensions in inches

| TOLERANCES (Unless otherwise specified) |        |
|---|--------|
| Hundredths                              | ±0.020 |
| Thousandths                             | ±0.005 |

## Header and Connection Diagrams

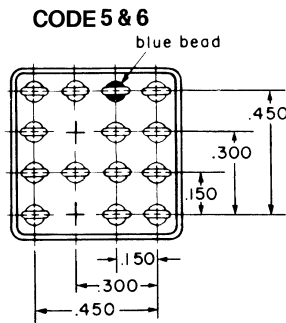
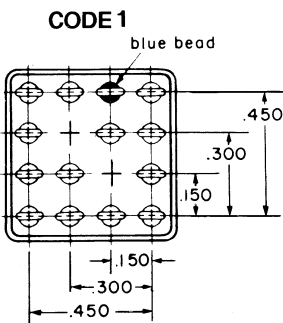
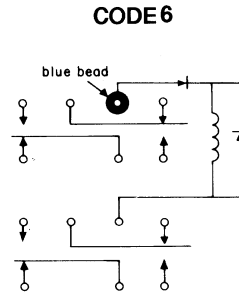
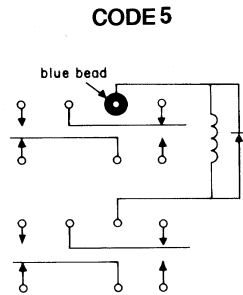
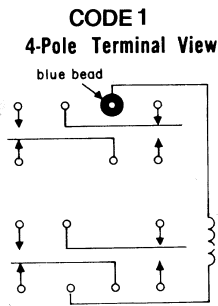

Terminals .020 dia

## ORDERING INSTRUCTIONS

**Catalog-selected Relays:** The catalog number is derived by choosing the proper CODE for each of the six relay characteristics in the order in which the codes are listed. Use the location guide (letters in vertical red columns) to find each CODE easily.

**Example:** The relay selected in this example is a 4PDT 150-grid relay, voltage calibrated end bracket mounting, 0.13-inch solder hook header, 720 ohms coil resistance, and 250 mW sensitivity. By choosing the proper code for each of these relay characteristics, the catalog number is identified as 35BH5131K5. The letter R following sensitivity code indicates relay received 5000 operation miss-test. Ex. 35BH5131K5R

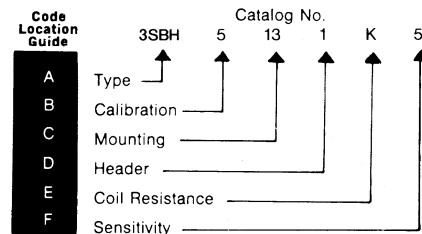

## Данный компонент на территории Российской Федерации

### Вы можете приобрести в компании MosChip.

Для оперативного оформления запроса Вам необходимо перейти по данной ссылке:

<http://moschip.ru/get-element>

Вы можете разместить у нас заказ для любого Вашего проекта, будь то серийное производство или разработка единичного прибора.

В нашем ассортименте представлены ведущие мировые производители активных и пассивных электронных компонентов.

Нашей специализацией является поставка электронной компонентной базы двойного назначения, продукции таких производителей как XILINX, Intel (ex.ALTERA), Vicor, Microchip, Texas Instruments, Analog Devices, Mini-Circuits, Amphenol, Glenair.

Сотрудничество с глобальными дистрибьюторами электронных компонентов, предоставляет возможность заказывать и получать с международных складов практически любой перечень компонентов в оптимальные для Вас сроки.

На всех этапах разработки и производства наши партнеры могут получить квалифицированную поддержку опытных инженеров.

Система менеджмента качества компании отвечает требованиям в соответствии с ГОСТ Р ИСО 9001, ГОСТ РВ 0015-002 и ЭС РД 009

### Офис по работе с юридическими лицами:

105318, г.Москва, ул.Щербаковская д.3, офис 1107, 1118, ДЦ «Щербаковский»

Телефон: +7 495 668-12-70 (многоканальный)

Факс: +7 495 668-12-70 (доб.304)

E-mail: [info@moschip.ru](mailto:info@moschip.ru)

Skype отдела продаж:

moschip.ru

moschip.ru\_4

moschip.ru\_6

moschip.ru\_9