

Features

- High current TRIAC
- Low thermal resistance with clip bonding
- High commutation capability
- BTA series UL1557 certified (File ref: 81734)
- Packages are RoHS (2002/95/EC) compliant

Applications

- On/off function in static relays, heating regulation, induction motor starting circuits
- Phase control operations in light dimmers, motor speed controllers, and similar

Description

Available in high power packages, the BTA/BTB40-41 series is suitable for general purpose AC switching.

The BTA series provides an insulated tab (rated at 2500 V rms).

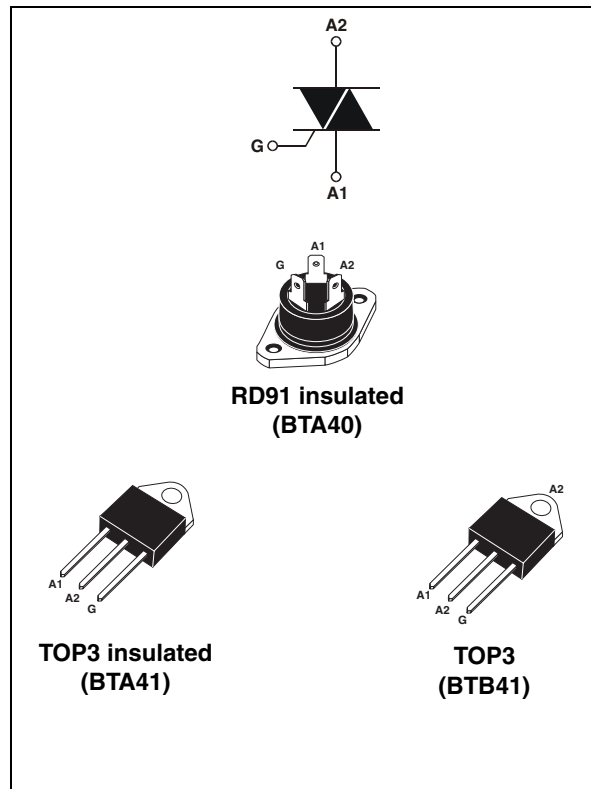

Table 1. Device summary

Symbol	Parameter	BTA40 ⁽¹⁾	BTA41 ⁽¹⁾	BTB41	Unit
$I_{T(RMS)}$	On-state rms current	40	41	41	A
V_{DRM}/V_{RRM}	Repetitive peak off-state voltage	600 and 800	600 and 800	600 and 800	V
I_{GT}	Triggering gate current	50	50	50	mA

1. Insulated package

1 Characteristics

Table 2. Absolute maximum ratings

Symbol	Parameter			Value	Unit
$I_{T(RMS)}$	On-state rms current (full sine wave)	TOP3	$T_c = 95\text{ °C}$	40	A
		RD91 / TOP ins.	$T_c = 80\text{ °C}$		
I_{TSM}	Non repetitive surge peak on-state current (full cycle, T_j initial = 25 °C)	F = 50 Hz	t = 20 ms	400	A
		F = 60 Hz	t = 16.7 ms	420	
I^2t	I^2t Value for fusing	$t_p = 10\text{ ms}$		1000	A ² s
di/dt	Critical rate of rise of on-state current $I_G = 2 \times I_{GT}$, $t_r \leq 100\text{ ns}$	F = 120 Hz	$T_j = 125\text{ °C}$	50	A/ μ s
V_{DSM}/V_{RSM}	Non repetitive surge peak off-state voltage	$t_p = 10\text{ ms}$	$T_j = 25\text{ °C}$	$V_{DSM}/V_{RSM} + 100$	V
I_{GM}	Peak gate current	$t_p = 20\text{ }\mu$ s	$T_j = 125\text{ °C}$	8	A
$P_{G(AV)}$	Average gate power dissipation		$T_j = 125\text{ °C}$	1	W
T_{stg} T_j	Storage junction temperature range Operating junction temperature range			- 40 to + 150 - 40 to + 125	°C

Table 3. Electrical characteristics ($T_j = 25\text{ °C}$, unless otherwise specified)

Symbol	Parameter			Value	Unit	
$I_{GT}^{(1)}$	$V_D = 12\text{ V}$ $R_L = 33\text{ }\Omega$	I - II - III	MAX.	50	mA	
		IV		100		
V_{GT}		ALL	MAX.	1.3	V	
V_{GD}	$V_D = V_{DRM}$ $R_L = 3.3\text{ k}\Omega$ $T_j = 125\text{ °C}$	ALL	MIN.	0.2	V	
$I_H^{(2)}$	$I_T = 500\text{ mA}$		MAX.	80	mA	
I_L	$I_G = 1.2 I_{GT}$	I - III - IV	MAX.	70	mA	
		II		160		
$dV/dt^{(2)}$	$V_D = 67\% V_{DRM}$ gate open	$T_j = 125\text{ °C}$	MIN.	500	V/ μ s	
$(dV/dt)_c^{(2)}$	$(di/dt)_c = 20\text{ A/ms}$		$T_j = 125\text{ °C}$	MIN.	10	V/ μ s

1. Minimum I_{GT} is guaranteed at 5% of I_{GT} max.
2. for both polarities of A2 referenced to A1

Table 4. Static characteristics

Symbol	Test conditions		Value	Unit	
$V_T^{(1)}$	$I_{TM} = 60\text{ A}$ $t_p = 380\ \mu\text{s}$	$T_j = 25\text{ }^\circ\text{C}$	MAX.	1.55	V
$V_{t0}^{(2)}$	Threshold voltage	$T_j = 125\text{ }^\circ\text{C}$	MAX.	0.85	V
$R_d^{(2)}$	Dynamic resistance	$T_j = 125\text{ }^\circ\text{C}$	MAX.	10	m Ω
I_{DRM} I_{RRM}	$V_{DRM} = V_{RRM}$	$T_j = 25\text{ }^\circ\text{C}$	MAX.	5	μA
		$T_j = 125\text{ }^\circ\text{C}$		5	mA

1. Minimum I_{GT} is guaranteed at 5% of I_{GT} max.
2. for both polarities of A2 referenced to A1

Table 5. Thermal resistance

Symbol	Test conditions		Value	Unit
$R_{th(j-c)}$	Junction to case (AC)	RD91 (insulated) / TOP3 insulated	0.9	$^\circ\text{C/W}$
		TOP3	0.6	
$R_{th(j-a)}$	Junction to ambient	TOP3 / TOP3 insulated	50	$^\circ\text{C/W}$

Figure 1. Maximum power dissipation versus on-state rms current (full cycle)

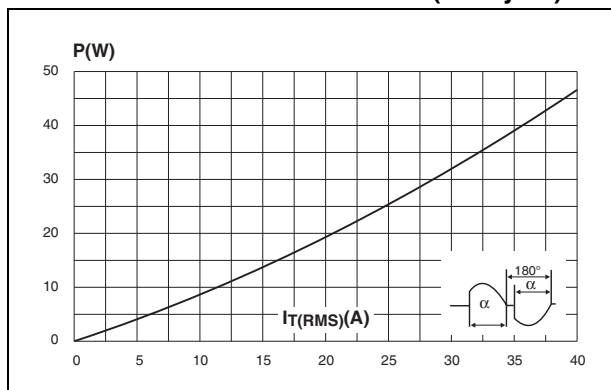

Figure 2. On-state rms current versus case temperature (full cycle)

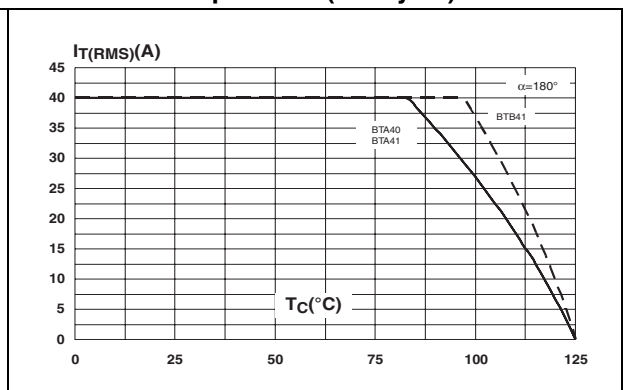

Figure 3. Relative variation of thermal impedance versus pulse duration

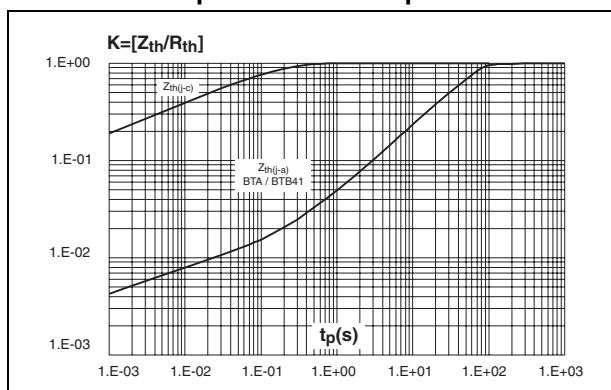

Figure 4. On-state characteristics (maximum values)

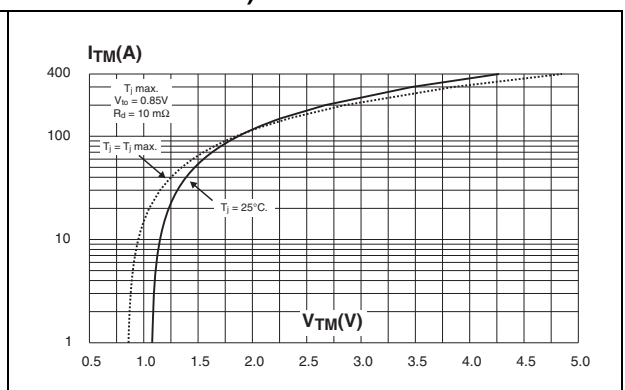

Figure 5. Surge peak on-state current versus number of cycles

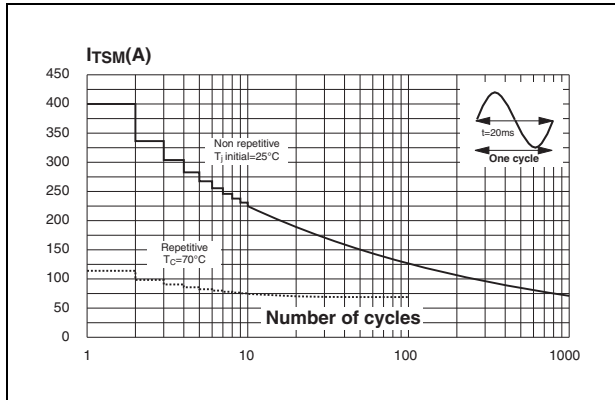

Figure 6. Non-repetitive surge peak on-state current for a sinusoidal pulse and corresponding value of I^2t

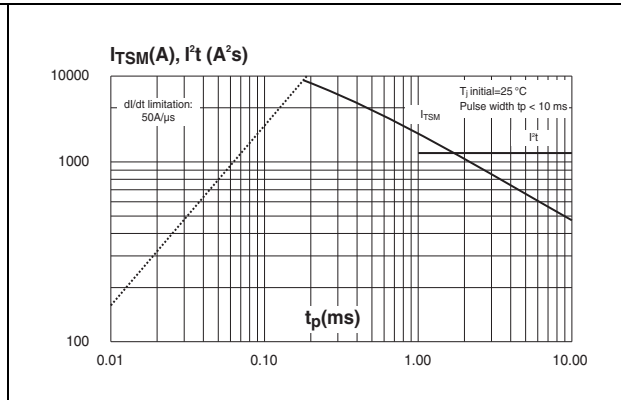

Figure 7. Relative variation of gate trigger, holding and latching current versus junction temperature

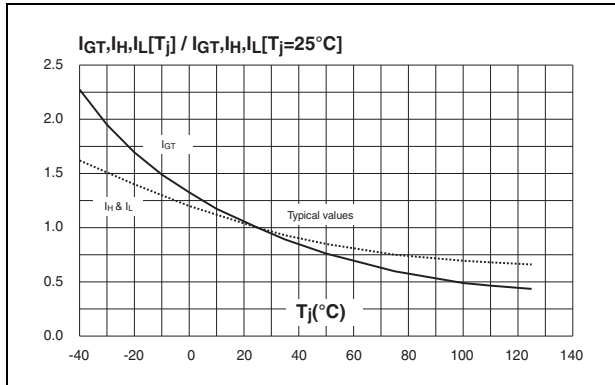

Figure 8. Relative variation of critical rate of decrease of main current versus $(dV/dt)c$ (typical values)

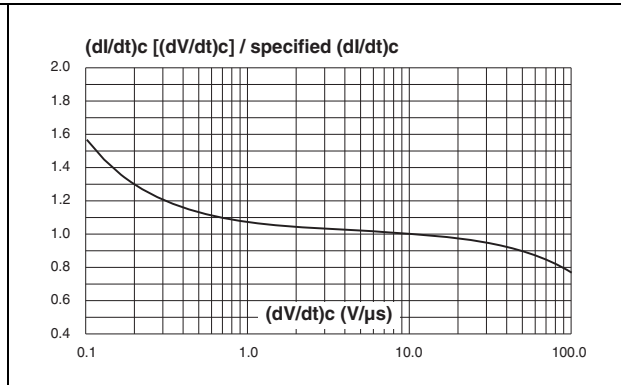
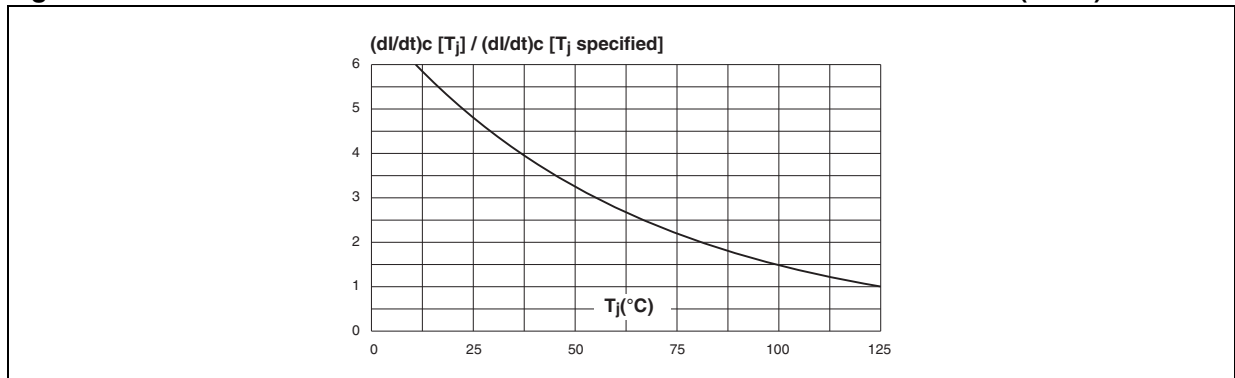
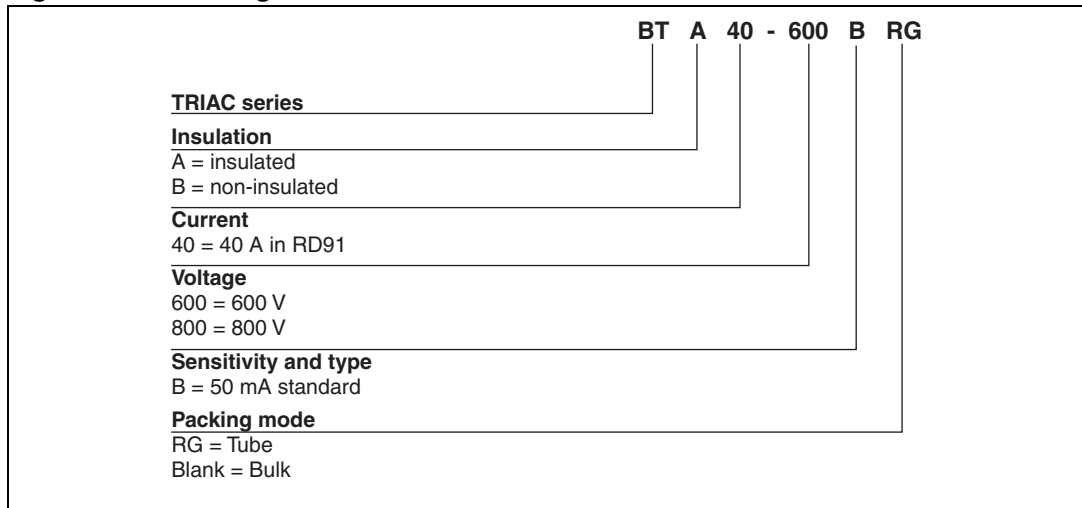

Figure 9. Relative variation of critical rate of decrease of main current versus $(dV/dt)c$



2 Ordering information scheme

Figure 10. Ordering information scheme



3 Package information

- Epoxy meets UL94, V0
- Lead-free packages

In order to meet environmental requirements, ST offers these devices in different grades of ECOPACK® packages, depending on their level of environmental compliance. ECOPACK® specifications, grade definitions and product status are available at: www.st.com. ECOPACK® is an ST trademark.

Table 6. TOP3 insulated and non-insulated dimensions

Ref.	Dimensions			
	Millimeters		Inches	
	Min.	Max.	Min.	Max.
A	4.4	4.6	0.173	0.181
B	1.45	1.55	0.057	0.061
C	14.35	15.60	0.565	0.614
D	0.5	0.7	0.020	0.028
E	2.7	2.9	0.106	0.114
F	15.8	16.5	0.622	0.650
G	20.4	21.1	0.815	0.831
H	15.1	15.5	0.594	0.610
J	5.4	5.65	0.213	0.222
K	3.4	3.65	0.134	0.144
ØL	4.08	4.17	0.161	0.164
P	1.20	1.40	0.047	0.055
R	4.60 typ.		0.181 typ.	

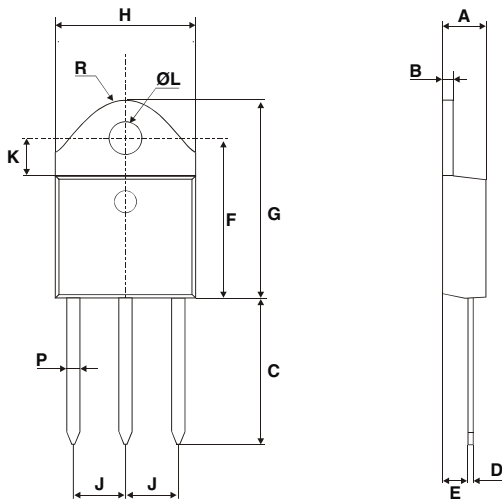

Table 7. RD91 dimensions

Ref.	Dimensions			
	Millimeters		Inches	
	Min.	Max.	Min.	Max.
A	-	40.00	-	1.575
A1	29.90	30.30	1.177	1.193
A2	-	22.00	-	0.867
B	-	27.00	-	1.063
B1	13.50	16.50	0.531	0.650
B2	-	24.00	-	0.945
C	-	14.00	-	0.551
C1	-	3.50	-	0.138
C2	1.95	3.00	0.077	0.118
E3	0.70	0.90	0.027	0.035
F	4.00	4.50	0.157	0.177
I	11.20	13.60	0.441	0.535
L1	3.10	3.50	0.122	0.138
L2	1.70	1.90	0.067	0.075
N1	33°	43°	33°	43°
N2	28°	38°	28°	38°

4 Ordering information

Table 8. Ordering information

Order code ⁽¹⁾	Marking	Package	Weight	Base qty	Delivery mode
BTA40-xxxB	BTA40xxxB	RD91	20 g	25	Bulk
BTA41-xxxBRG	BTA41xxxB	TOP3 Ins.	4.5 g	30	Tube
BTB41-xxxBRG	BTB41xxxB	TOP3	4.5 g	30	Tube

1. xxx = voltage

5 Revision history

Table 9. Document revision history

Date	Revision	Changes
Sep-2003	5	Last update.
25-Mar-2005	6	TOP3 delivery mode changed from bulk to tube.
14-Oct-2005	7	T _c values for I _T changed in Table 3. ECOPACK statement added.
10-Aug-2009	8	Updated Table 2 to correctly place packages. Updated Figure 2 . Table 5 changed to correctly place TOP3. Updated ECOPACK statement.

Please Read Carefully:

Information in this document is provided solely in connection with ST products. STMicroelectronics NV and its subsidiaries ("ST") reserve the right to make changes, corrections, modifications or improvements, to this document, and the products and services described herein at any time, without notice.

All ST products are sold pursuant to ST's terms and conditions of sale.

Purchasers are solely responsible for the choice, selection and use of the ST products and services described herein, and ST assumes no liability whatsoever relating to the choice, selection or use of the ST products and services described herein.

No license, express or implied, by estoppel or otherwise, to any intellectual property rights is granted under this document. If any part of this document refers to any third party products or services it shall not be deemed a license grant by ST for the use of such third party products or services, or any intellectual property contained therein or considered as a warranty covering the use in any manner whatsoever of such third party products or services or any intellectual property contained therein.

UNLESS OTHERWISE SET FORTH IN ST'S TERMS AND CONDITIONS OF SALE ST DISCLAIMS ANY EXPRESS OR IMPLIED WARRANTY WITH RESPECT TO THE USE AND/OR SALE OF ST PRODUCTS INCLUDING WITHOUT LIMITATION IMPLIED WARRANTIES OF MERCHANTABILITY, FITNESS FOR A PARTICULAR PURPOSE (AND THEIR EQUIVALENTS UNDER THE LAWS OF ANY JURISDICTION), OR INFRINGEMENT OF ANY PATENT, COPYRIGHT OR OTHER INTELLECTUAL PROPERTY RIGHT.

UNLESS EXPRESSLY APPROVED IN WRITING BY AN AUTHORIZED ST REPRESENTATIVE, ST PRODUCTS ARE NOT RECOMMENDED, AUTHORIZED OR WARRANTED FOR USE IN MILITARY, AIR CRAFT, SPACE, LIFE SAVING, OR LIFE SUSTAINING APPLICATIONS, NOR IN PRODUCTS OR SYSTEMS WHERE FAILURE OR MALFUNCTION MAY RESULT IN PERSONAL INJURY, DEATH, OR SEVERE PROPERTY OR ENVIRONMENTAL DAMAGE. ST PRODUCTS WHICH ARE NOT SPECIFIED AS "AUTOMOTIVE GRADE" MAY ONLY BE USED IN AUTOMOTIVE APPLICATIONS AT USER'S OWN RISK.

Resale of ST products with provisions different from the statements and/or technical features set forth in this document shall immediately void any warranty granted by ST for the ST product or service described herein and shall not create or extend in any manner whatsoever, any liability of ST.

ST and the ST logo are trademarks or registered trademarks of ST in various countries.

Information in this document supersedes and replaces all information previously supplied.

The ST logo is a registered trademark of STMicroelectronics. All other names are the property of their respective owners.

© 2009 STMicroelectronics - All rights reserved

STMicroelectronics group of companies

Australia - Belgium - Brazil - Canada - China - Czech Republic - Finland - France - Germany - Hong Kong - India - Israel - Italy - Japan - Malaysia - Malta - Morocco - Philippines - Singapore - Spain - Sweden - Switzerland - United Kingdom - United States of America

www.st.com

Данный компонент на территории Российской Федерации

Вы можете приобрести в компании MosChip.

Для оперативного оформления запроса Вам необходимо перейти по данной ссылке:

<http://moschip.ru/get-element>

Вы можете разместить у нас заказ для любого Вашего проекта, будь то серийное производство или разработка единичного прибора.

В нашем ассортименте представлены ведущие мировые производители активных и пассивных электронных компонентов.

Нашей специализацией является поставка электронной компонентной базы двойного назначения, продукции таких производителей как XILINX, Intel (ex.ALTERA), Vicor, Microchip, Texas Instruments, Analog Devices, Mini-Circuits, Amphenol, Glenair.

Сотрудничество с глобальными дистрибьюторами электронных компонентов, предоставляет возможность заказывать и получать с международных складов практически любой перечень компонентов в оптимальные для Вас сроки.

На всех этапах разработки и производства наши партнеры могут получить квалифицированную поддержку опытных инженеров.

Система менеджмента качества компании отвечает требованиям в соответствии с ГОСТ Р ИСО 9001, ГОСТ РВ 0015-002 и ЭС РД 009

Офис по работе с юридическими лицами:

105318, г.Москва, ул.Щербаковская д.3, офис 1107, 1118, ДЦ «Щербаковский»

Телефон: +7 495 668-12-70 (многоканальный)

Факс: +7 495 668-12-70 (доб.304)

E-mail: info@moschip.ru

Skype отдела продаж:

moschip.ru

moschip.ru_4

moschip.ru_6

moschip.ru_9