

## DUAL OPERATIONAL AMPLIFIER

### ■ GENERAL DESCRIPTION

The NJM8065 integrated circuit is a high-gain, wide bandwidth, dual operational amplifier.

The NJM8065 combines many of the features of the NJM4558 as well as providing the capability of wider bandwidth (10MHz typ.), and higher slew rate (4V/μs typ.) make the NJM8065 ideal for active filters, data and telecommunications, and many instrumentation applications.

### ■ PACKAGE OUTLINE



NJM8065G  
(SOP8)



NJM8065M  
(DMP8)



NJM8065RB1  
(MSOP8 (TVSP8))



NJM8065V  
(SSOP8)

### ■ FEATURES

- Operating Voltage  $\pm 4V$  to  $\pm 18V$
- Wide Gain Bandwidth Product 10MHz typ.
- Slew Rate 4V/μs typ.
- Package Outline SOP8, DMP8  
MSOP8 (TVSP8)\*  
\*MEET JEDEC MO-187-DA / THIN TYPE  
SSOP8
- Bipolar Technology
- Internal ESD protection  
Human body model (HBM)  $\pm 2000V$  typ.
- Wide temperature range  $-40^{\circ}C$  to  $+125^{\circ}C$

### ■ PIN CONFIGURATION

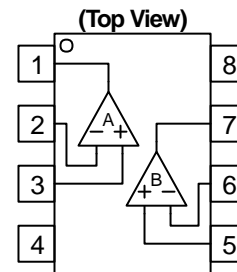

- PIN FUNCTION**
- 1.A OUTPUT
  - 2.A - INPUT
  - 3.A + INPUT
  - 4.V<sup>-</sup>
  - 5.B + INPUT
  - 6.B - INPUT
  - 7.B OUTPUT
  - 8.V<sup>+</sup>

NJM8065G  
NJM8065M  
NJM8065RB1  
NJM8065V

### ■ EQUIVALENT CIRCUIT ( 1/2 Shown )

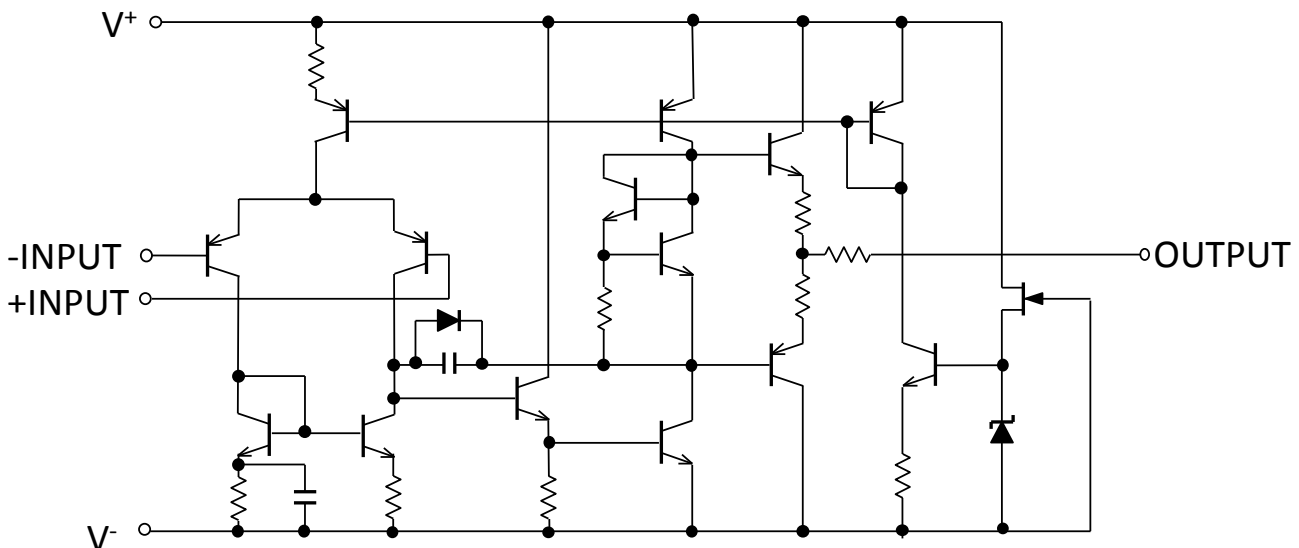

# NJM8065

## ■ ABSOLUTE MAXIMUM RATINGS (Ta=25°C, unless otherwise noted.)

PARAMETER	SYMBOL	RATINGS	UNIT
Supply Voltage	V <sup>+</sup> /V <sup>-</sup>	±18	V
Differential Input Voltage (Note1)	V <sub>ID</sub>	±36	V
Input Voltage (Note2)	V <sub>IN</sub>	V <sup>-</sup> -0.3 to V <sup>+</sup> +36	V
Output Terminal Input Voltage	V <sub>O</sub>	V <sup>-</sup> -0.3 to V <sup>+</sup> +0.3	V
Power Dissipation	P <sub>D</sub>	SOP : 690(Note3) 1000(Note4) DMP : 470(Note3) 600(Note4) MSOP : 510(Note3) 680(Note4) SSOP : 430 (Note3) 540(Note4)	mW
Operating Temperature Range	T <sub>opr</sub>	-40~+125	°C
Storage Temperature Range	T <sub>stg</sub>	-65~+150	°C

(Note1) Differential voltage is the voltage difference between +INPUT and -INPUT.

(Note2) Input voltage is the voltage should be allowed to apply to the input terminal independent of the magnitude of V<sup>+</sup>.

The normal operation will establish when any input is within the Common Mode Input Voltage Range of electrical characteristics.

( Note3) EIA/JEDEC STANDARD Test board (76.2 x 114.3 x 1.6mm, 2layers, FR-4) mounting

( Note4) EIA/JEDEC STANDARD Test board (76.2 x 114.3 x 1.6mm, 4layers, FR-4) mounting

## ■ RECOMMENDED OPERATING CONDITIONS (Ta=25°C)

PARAMETER	SYMBOL	CONDITION	MIN.	TYP.	MAX.	UNIT
Supply Voltage	V <sup>+</sup> /V <sup>-</sup>		±4	-	±18	V

## ■ ELECTRICAL CHARACTERISTICS (V<sup>+</sup>/V<sup>-</sup>=±15V, Ta=25°C, unless otherwise noted.)

PARAMETER	SYMBOL	TEST CONDITION	MIN.	TYP.	MAX.	UNIT
Input Offset Voltage	V <sub>IO</sub>	R <sub>S</sub> ≤10kΩ	-	0.5	3	mV
Input Offset Current	I <sub>IO</sub>		-	2	50	nA
Input Bias Current	I <sub>B</sub>		-	50	200	nA
Input Resistance	R <sub>IN</sub>		-	1	-	MΩ
Large Signal Voltage Gain	A <sub>V</sub>	R <sub>L</sub> ≥2kΩ, V <sub>O</sub> =±10V	86	100	-	dB
Maximum Output Voltage Swing 1	V <sub>OM1</sub>	R <sub>L</sub> ≥2kΩ	± 12	± 14	-	V
Maximum Output Voltage Swing 2	V <sub>OM2</sub>	I <sub>O</sub> =25mA	± 10	± 11.5	-	V
Input Common Mode Voltage Range	V <sub>ICM</sub>		± 12	± 14	-	V
Common Mode Rejection Ratio	CMR	R <sub>S</sub> ≤10kΩ	70	95	-	dB
Supply Voltage Rejection Ratio	SVR	R <sub>S</sub> ≤10kΩ	76.5	100	-	dB
Operating Current	I <sub>CC</sub>		-	4.5	7	mA
Slew Rate	SR		-	4	-	V/μs
Gain Bandwidth Product	GBP	f=10kHz	-	10	-	MHz
Equivalent Input Noise Voltage	e <sub>n</sub>	f=1kHz	-	8	-	nV/√Hz

## ■ TYPICAL CHARACTERISTICS

**Gain/Phase vs. Frequency**

$V^+V^-\approx\pm 15V$ ,  $R_L=2k\Omega$ ,  $G_V=40dB$

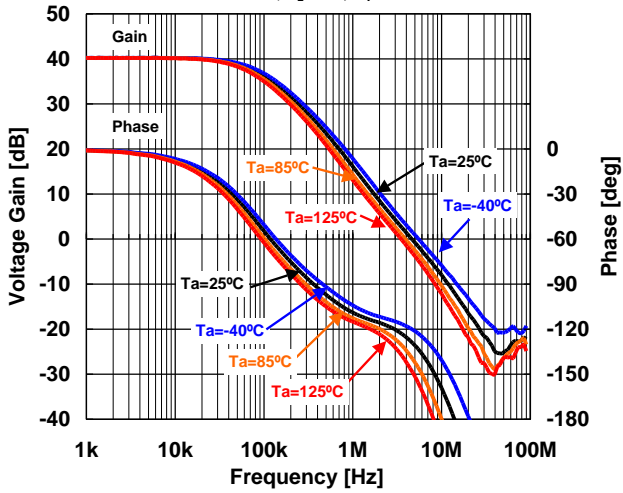

**Maximum Output Voltage Swing vs. Frequency**

$V^+V^-\approx\pm 15V$ ,  $R_L=2k\Omega$ ,  $T_a=25^\circ C$

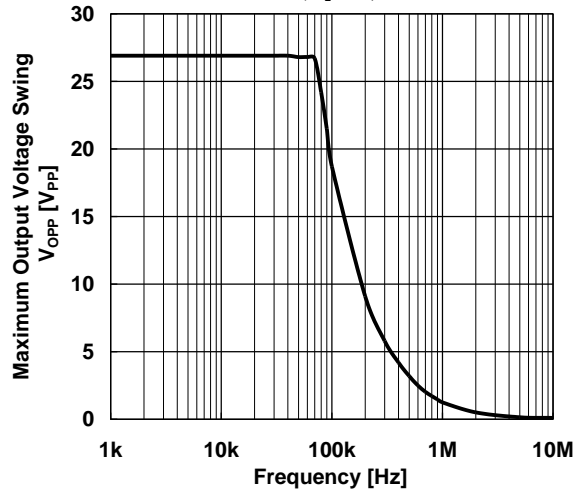

**Maximum Output Voltage Swing vs. Load Resistance**

$V^+V^-\approx\pm 15V$ ,  $T_a=25^\circ C$

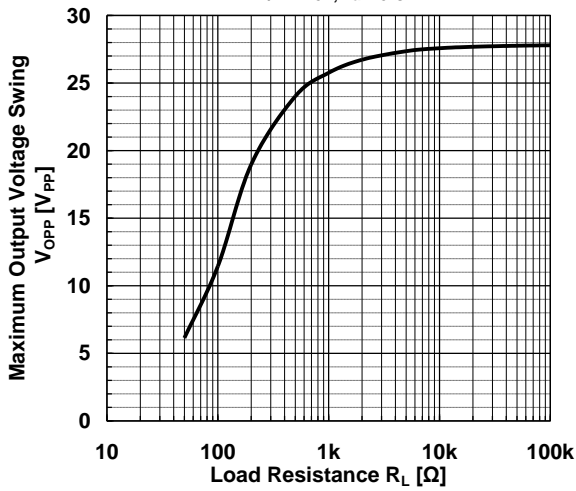

**Maximum Output Voltage vs. Load Resistance**

$V^+V^-\approx\pm 15V$

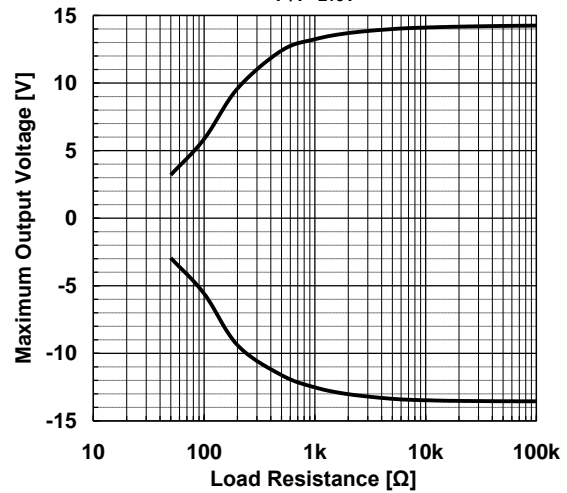

**Voltage Noise vs. Frequency**

$V^+V^-\approx\pm 15V$ ,  $G_V=40dB$ ,  $R_f=2k\Omega$ ,  $T_a=25^\circ C$

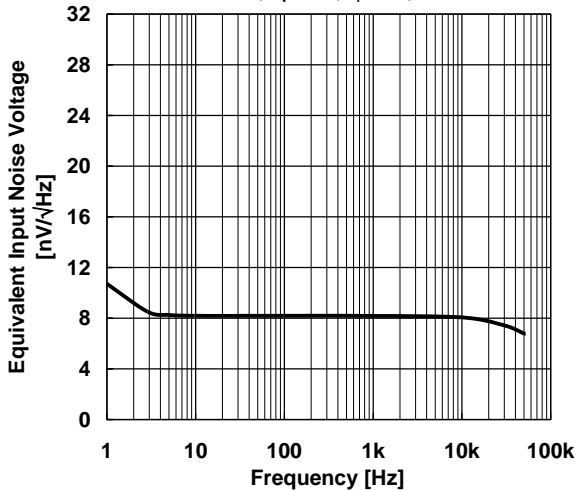

**THD+N vs. Output Voltage**

$V^+V^-\approx\pm 15V$ ,  $G_V=20dB$ ,  $R_G=10k\Omega$ ,  $R_S=200\Omega$ ,  $R_f=2k\Omega$ ,  $T_a=25^\circ C$

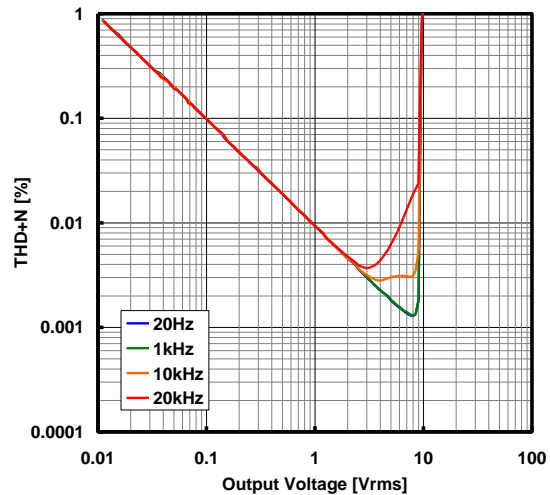

# NJM8065

## ■ TYPICAL CHARACTERISTICS

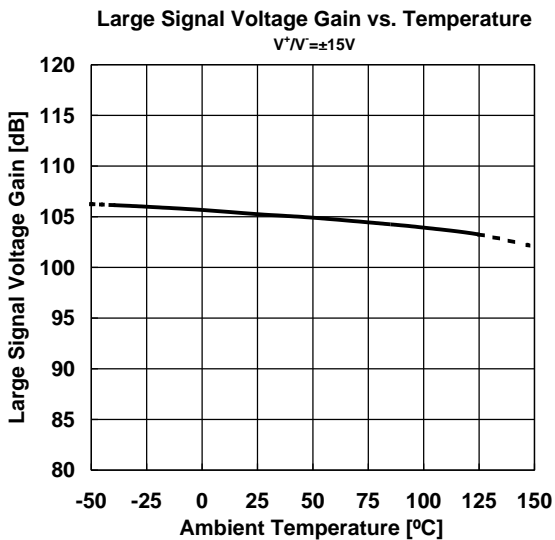
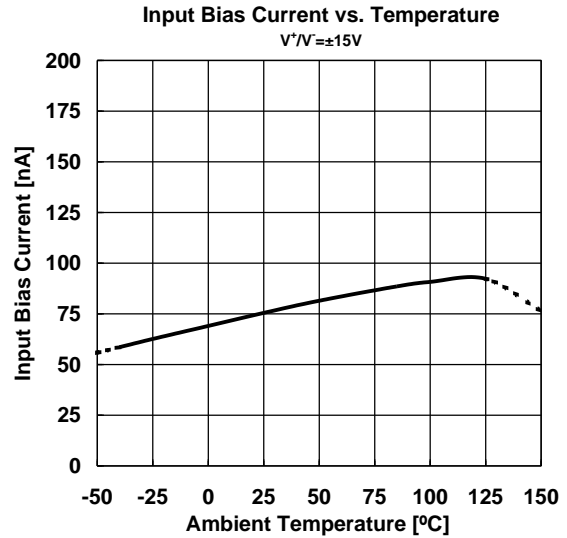
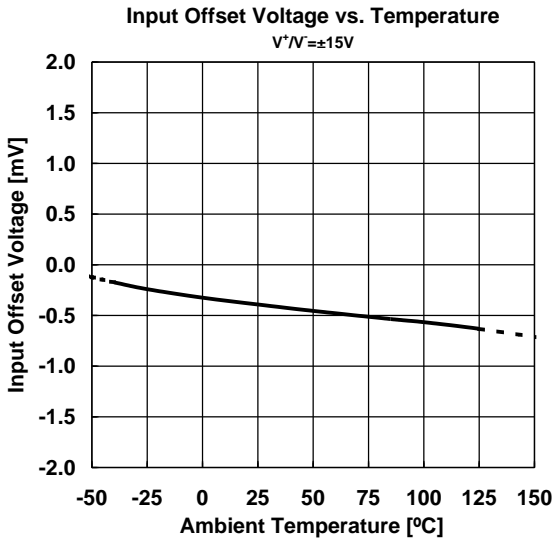
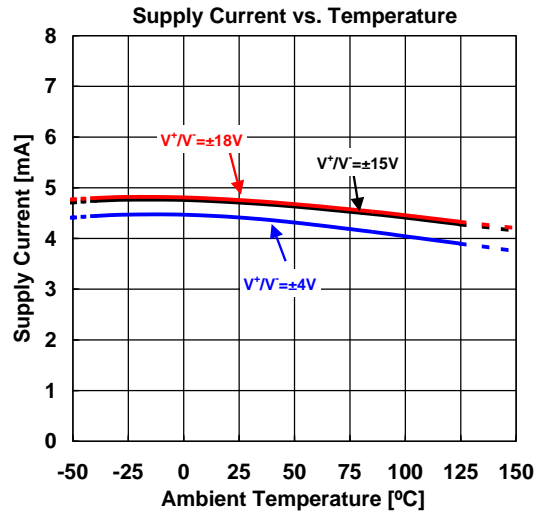
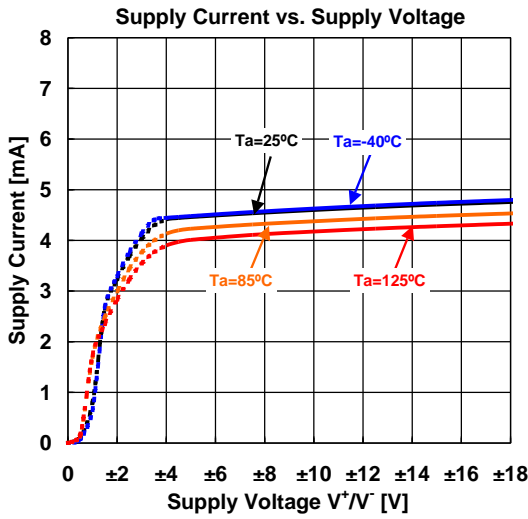

## ■ TYPICAL CHARACTERISTICS

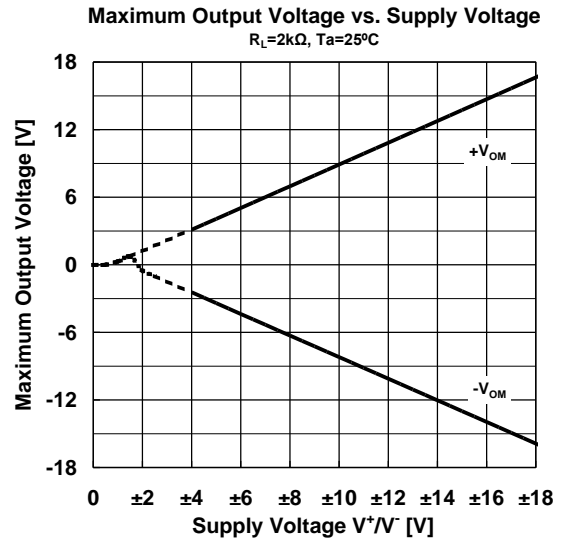
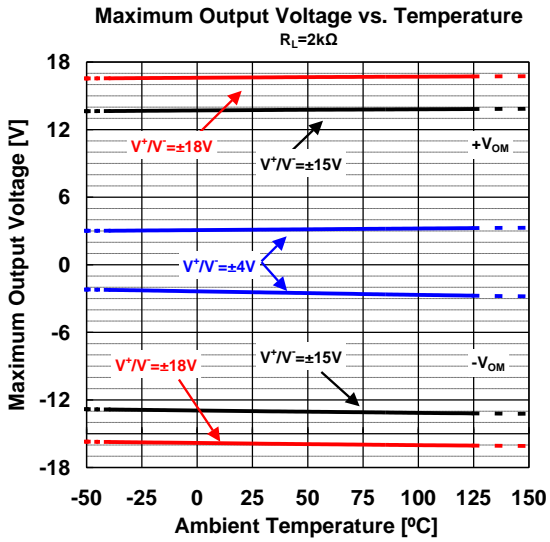
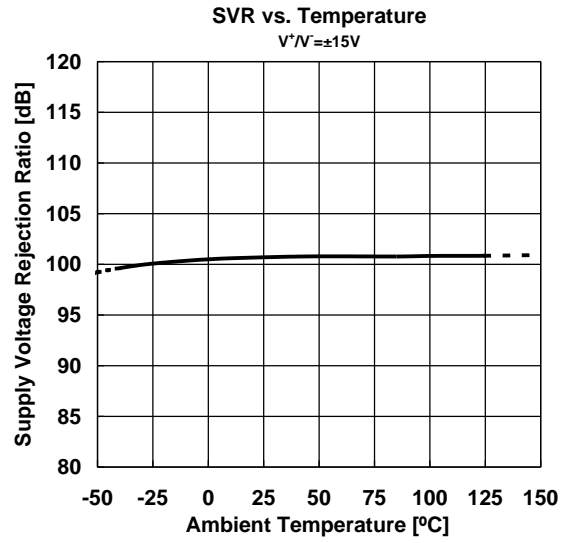
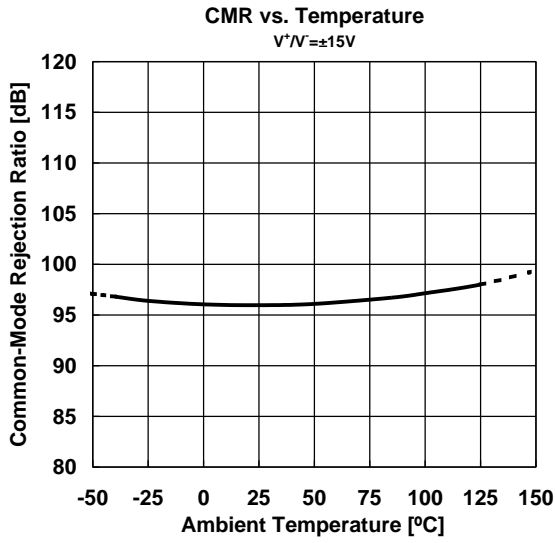

# NJM8065

■PACKAGE OUTLINE UNIT : mm

SOP8

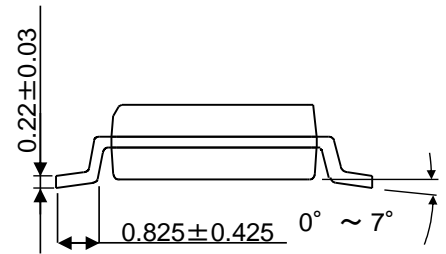
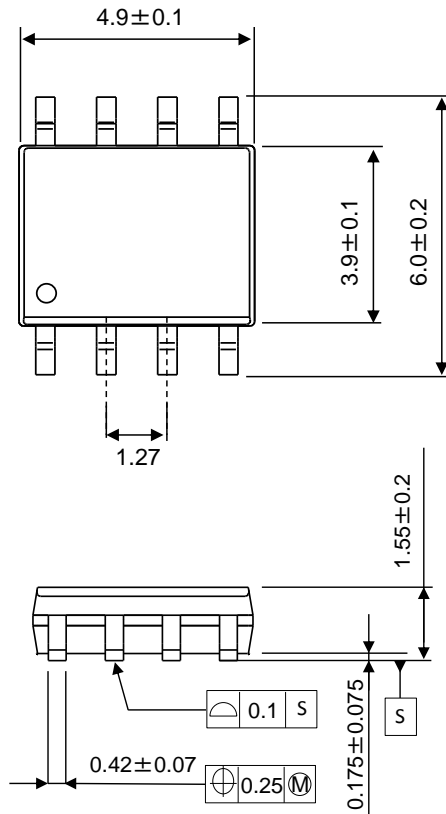

DMP8

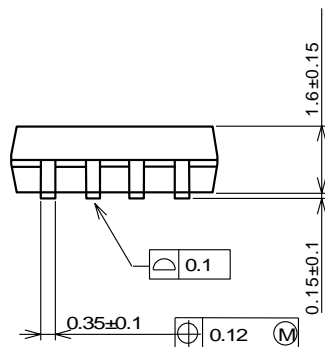
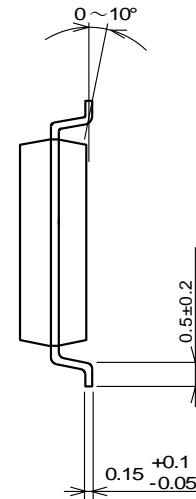
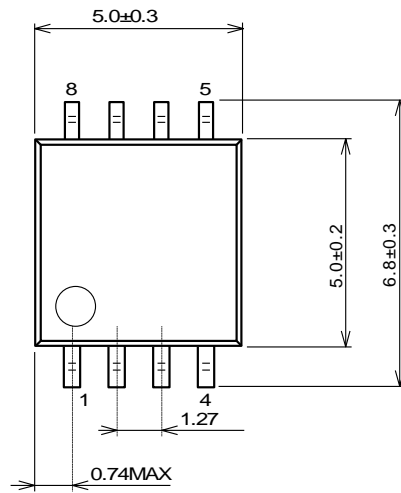

## ■PACKAGE OUTLINE UNIT : mm

### MSOP8 (TVSP8)\*

\*MEET JEDEC MO-187-DA/ THIN TYPE

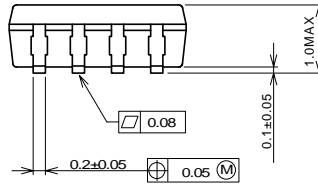
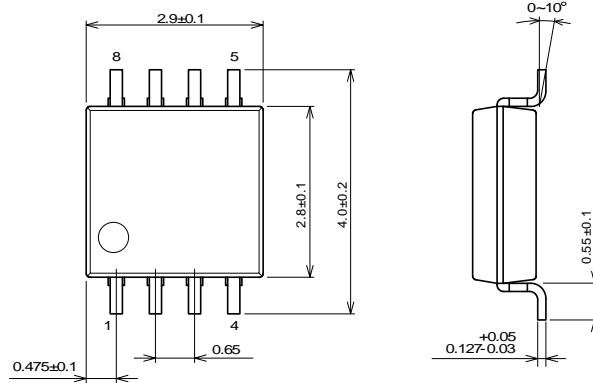

### SSOP8

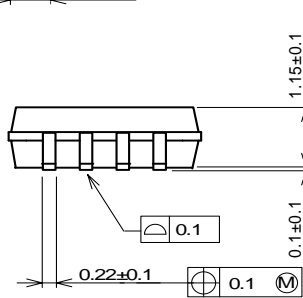
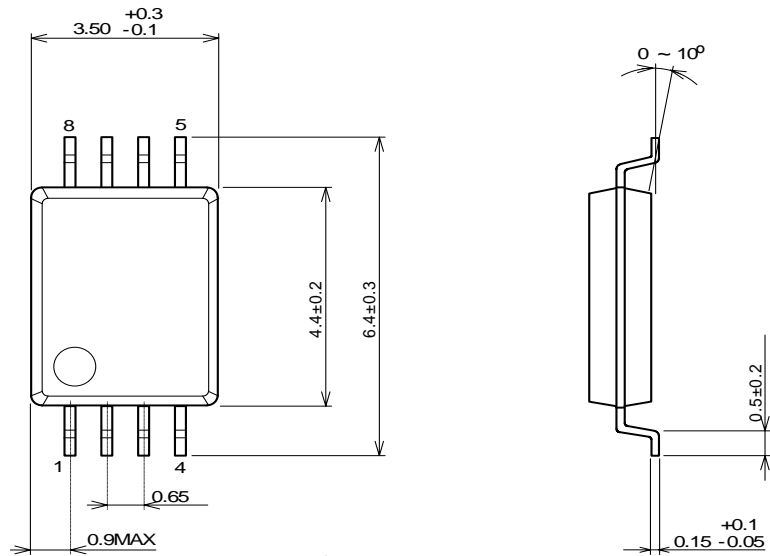

**[CAUTION]**

The specifications on this databook are only given for information, without any guarantee as regards either mistakes or omissions. The application circuits in this databook are described only to show representative usages of the product and not intended for the guarantee or permission of any right including the industrial rights.

# Mouser Electronics

Authorized Distributor

Click to View Pricing, Inventory, Delivery & Lifecycle Information:

[NJR:](#)

[NJM8065G-TE2](#)

## Данный компонент на территории Российской Федерации

### Вы можете приобрести в компании MosChip.

Для оперативного оформления запроса Вам необходимо перейти по данной ссылке:

<http://moschip.ru/get-element>

Вы можете разместить у нас заказ для любого Вашего проекта, будь то серийное производство или разработка единичного прибора.

В нашем ассортименте представлены ведущие мировые производители активных и пассивных электронных компонентов.

Нашей специализацией является поставка электронной компонентной базы двойного назначения, продукции таких производителей как XILINX, Intel (ex.ALTERA), Vicor, Microchip, Texas Instruments, Analog Devices, Mini-Circuits, Amphenol, Glenair.

Сотрудничество с глобальными дистрибьюторами электронных компонентов, предоставляет возможность заказывать и получать с международных складов практически любой перечень компонентов в оптимальные для Вас сроки.

На всех этапах разработки и производства наши партнеры могут получить квалифицированную поддержку опытных инженеров.

Система менеджмента качества компании отвечает требованиям в соответствии с ГОСТ Р ИСО 9001, ГОСТ РВ 0015-002 и ЭС РД 009

### Офис по работе с юридическими лицами:

105318, г.Москва, ул.Щербаковская д.3, офис 1107, 1118, ДЦ «Щербаковский»

Телефон: +7 495 668-12-70 (многоканальный)

Факс: +7 495 668-12-70 (доб.304)

E-mail: [info@moschip.ru](mailto:info@moschip.ru)

Skype отдела продаж:

moschip.ru

moschip.ru\_4

moschip.ru\_6

moschip.ru\_9