

TwinChip™ Series - DO-214



Agency Approvals

| Agency | Agency File Number |
|--------|--------------------|
| | E133083 |

Description

TwinChip™ Series DO-214 are very low capacitance SIDACtor® thyristors designed to protect broadband equipment such as VoIP, DSL modems and DSLAMs from damaging overvoltage transients. This series provides a surface mount solution that enables equipment to comply with global regulatory standards, while limiting the impact to broadband signals.

Features and Benefits

- Low voltage overshoot
- Low on-state voltage
- Does not degrade surge capability after multiple surge events within limit.
- Low distortion
- Fails short circuit when surged in excess of ratings
- 40% lower than comparable product
- RoHS Compliant and Halogen-Free
- Pb-free E3 means 2nd level interconnect is Pb-free and the terminal finish material is tin(Sn) (IPC/JEDEC J-STD-609A.01)
- Recognized to UL 497B as an Isolated Loop Circuit Protector

Schematic Symbol



Applicable Global Standards

- TIA/968-A/B
- ITU K.20/21/45
- IEC 61000-4-5 2nd edition
- GR 1089 Intra-building
- YD/T 1082
- YD/T 993
- YD/T 950
- ITU K.20/21/45 Enhanced*
- GR 1089 Inter-building*

* Additional series resistance may be required to comply

Additional Information



Datasheet



Resources



Samples

Electrical Characteristics

| Part Number | Marking | V_{DRM} @ $I_{DRM} = 5\mu A$ | V_S @ 100V/ μs | I_H | I_S | I_T | V_T @ $I_T = 2.2$ Amps | @ 1MHz, 2V bias | |
|-------------|---------|-----------------------------------|--------------------------|--------|--------|-------|-----------------------------|-----------------|--------|
| | | V min | V max | mA min | mA max | A max | V max | pF min | pF max |
| P0642SALRP | P062A | 58 | 77 | 120 | 800 | 2.2 | 8 | 25 | 45 |
| P0722SALRP | P072A | 65 | 88 | 120 | 800 | 2.2 | 8 | 20 | 45 |
| P0902SALRP | P092A | 75 | 98 | 120 | 800 | 2.2 | 8 | 20 | 40 |
| P1102SALRP | P112A | 90 | 130 | 120 | 800 | 2.2 | 8 | 15 | 35 |
| P1302SALRP | P132A | 120 | 160 | 120 | 800 | 2.2 | 8 | 15 | 35 |
| P1502SALRP | P152A | 140 | 180 | 120 | 800 | 2.2 | 8 | 15 | 30 |
| P1802SALRP | P182A | 170 | 220 | 120 | 800 | 2.2 | 8 | 10 | 30 |
| P2302SALRP | P232A | 190 | 260 | 120 | 800 | 2.2 | 8 | 10 | 25 |
| P2602SALRP | P262A | 220 | 300 | 120 | 800 | 2.2 | 8 | 10 | 25 |
| P3002SALRP | P302A | 280 | 360 | 120 | 800 | 2.2 | 8 | 10 | 25 |
| P3502SALRP | P352A | 320 | 400 | 120 | 800 | 2.2 | 8 | 10 | 20 |
| P4202SALRP | P422A | 380 | 500 | 120 | 800 | 2.2 | 8 | 10 | 20 |
| P4802SALRP | P482A | 440 | 600 | 120 | 800 | 2.2 | 8 | 5 | 20 |
| P6002SALRP | P602A | 550 | 700 | 120 | 800 | 2.2 | 8 | 5 | 20 |
| P0642SBLRP | P062B | 58 | 77 | 120 | 800 | 2.2 | 8 | 25 | 45 |
| P0722SBLRP | P072B | 65 | 88 | 120 | 800 | 2.2 | 8 | 20 | 45 |
| P0902SBLRP | P092B | 75 | 98 | 120 | 800 | 2.2 | 8 | 20 | 40 |
| P1102SBLRP | P112B | 90 | 130 | 120 | 800 | 2.2 | 8 | 15 | 35 |
| P1302SBLRP | P132B | 120 | 160 | 120 | 800 | 2.2 | 8 | 15 | 35 |
| P1502SBLRP | P152B | 140 | 180 | 120 | 800 | 2.2 | 8 | 15 | 30 |
| P1802SBLRP | P182B | 170 | 220 | 120 | 800 | 2.2 | 8 | 10 | 30 |
| P2302SBLRP | P232B | 190 | 260 | 120 | 800 | 2.2 | 8 | 10 | 25 |
| P2602SBLRP | P262B | 220 | 300 | 120 | 800 | 2.2 | 8 | 10 | 25 |
| P3002SBLRP | P302B | 280 | 360 | 120 | 800 | 2.2 | 8 | 10 | 25 |
| P3502SBLRP | P352B | 320 | 400 | 120 | 800 | 2.2 | 8 | 10 | 20 |
| P4202SBLRP | P422B | 380 | 500 | 120 | 800 | 2.2 | 8 | 10 | 20 |
| P4802SBLRP | P482B | 440 | 600 | 120 | 800 | 2.2 | 8 | 5 | 20 |
| P6002SBLRP | P602B | 550 | 700 | 120 | 800 | 2.2 | 8 | 5 | 20 |
| P3002SCLRP | P302C | 280 | 360 | 120 | 800 | 2.2 | 8 | 20 | 35 |
| P3502SCLRP | P352C | 320 | 400 | 120 | 800 | 2.2 | 8 | 20 | 30 |
| P4202SCLRP | P422C | 380 | 500 | 120 | 800 | 2.2 | 8 | 15 | 30 |
| P4802SCLRP | P482C | 440 | 600 | 120 | 800 | 2.2 | 8 | 15 | 30 |
| P6002SCLRP | P602C | 550 | 700 | 120 | 800 | 2.2 | 8 | 10 | 25 |
| P7002SCLRP | P702C | 640 | 850 | 120 | 800 | 2.2 | 8 | 10 | 30 |

Notes:

- Absolute maximum ratings measured at $T_A = 25^\circ C$ (unless otherwise noted).
- Components are bi-directional.

Surge Ratings

| Series | I_{PP} | | | | | | | | | I_{TSM} 50/60 Hz | di/dt |
|----------|--|--|--|--|--|--|--|--|---|-----------------------|-------|
| | 0.2/310 ¹ 0.5/700 ² | 2/10 ¹ 2/10 ² | 8/20 ¹ 1.2/50 ² | 10/160 ¹ 10/160 ² | 10/560 ¹ 10/560 ² | 5/320 ¹ 9/720 ² | 10/360 ¹ 10/360 ² | 10/1000 ¹ 10/1000 ² | 5/310 ¹ 10/700 ² | | |
| | A min | A min | A min | A min | A min | A min | A min | A min | A min | | |
| A | 20 | 150 | 150 | 90 | 50 | 75 | 75 | 45 | 75 | 20 | 500 |
| B | 25 | 250 | 250 | 150 | 100 | 100 | 125 | 80 | 100 | 25 | 500 |
| C | 50 | 500 | 400 | 200 | 150 | 200 | 175 | 100 | 200 | 30 | 500 |

Notes:

- Current waveform in μs
 - Voltage waveform in μs
- Peak pulse current rating (I_{PP}) is repetitive and guaranteed for the life of the product that remains in thermal equilibrium.
 - I_{PP} ratings applicable over temperature range of $-40^\circ C$ to $+85^\circ C$
 - The component must initially be in thermal equilibrium with $-40^\circ C \leq T_J \leq +150^\circ C$

Thermal Considerations

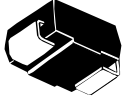
| Package | Symbol | Parameter | Value | Unit |
|---|-----------------|---|-------------|------|
|  DO-214AA | T_J | Operating Junction Temperature Range | -40 to +150 | °C |
| | T_S | Storage Temperature Range | -65 to +150 | °C |
| | $R_{\theta JA}$ | Thermal Resistance: Junction to Ambient | 90 | °C/W |

V-I Characteristics

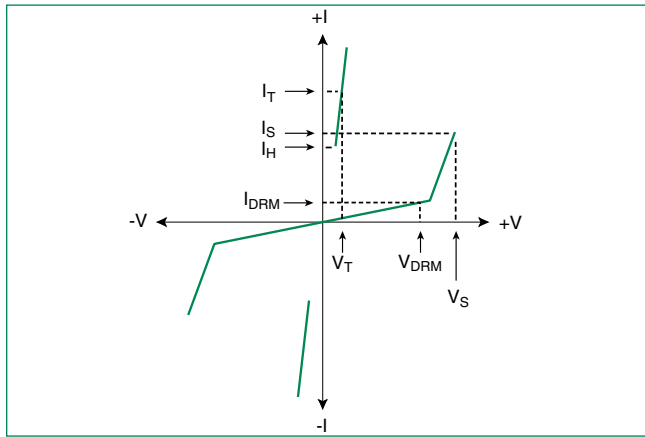

$t_r \times t_d$ Pulse Waveform

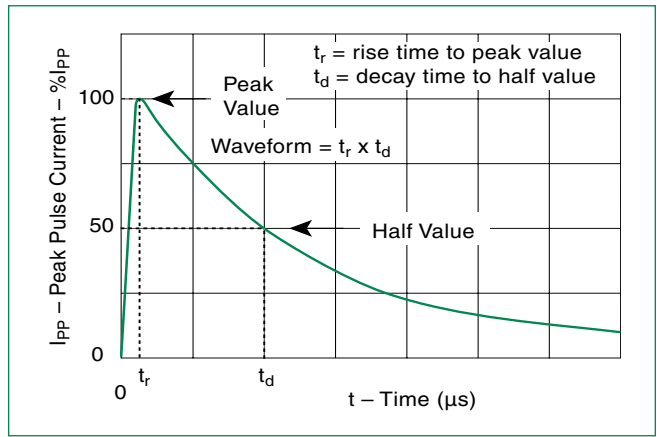

Normalized V_S Change vs. Junction Temperature

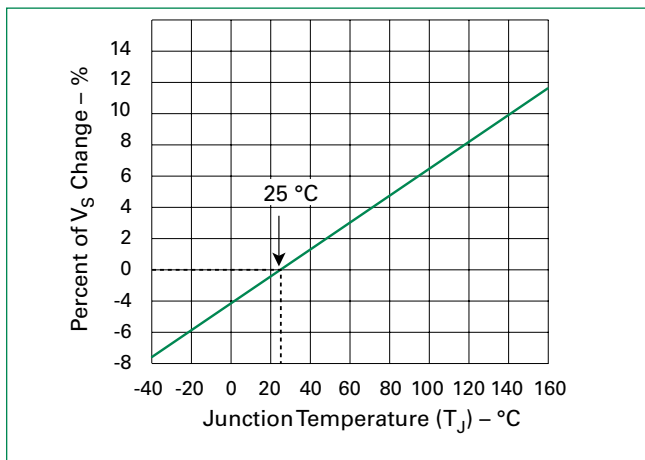

Normalized DC Holding Current vs. Case Temperature

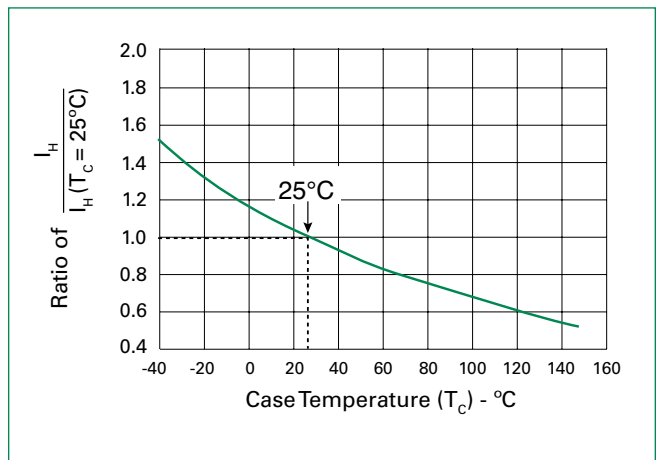

Soldering Parameters

| | | |
|--|------------------------------------|------------------|
| Reflow Condition | | Pb-Free assembly |
| Pre Heat | - Temperature Min ($T_{s(min)}$) | +150°C |
| | - Temperature Max ($T_{s(max)}$) | +200°C |
| | - Time (Min to Max) (t_s) | 60-180 secs. |
| Average ramp up rate (Liquidus Temp (T_L) to peak) | | 3°C/sec. Max. |
| $T_{s(max)}$ to T_L - Ramp-up Rate | | 3°C/sec. Max. |
| Reflow | - Temperature (T_L) (Liquidus) | +217°C |
| | - Temperature (t_L) | 60-150 secs. |
| Peak Temp (T_p) | | +260(+0/-5)°C |
| Time within 5°C of actual Peak Temp (t_p) | | 30 secs. Max. |
| Ramp-down Rate | | 6°C/sec. Max. |
| Time 25°C to Peak Temp (T_p) | | 8 min. Max. |
| Do not exceed | | +260°C |

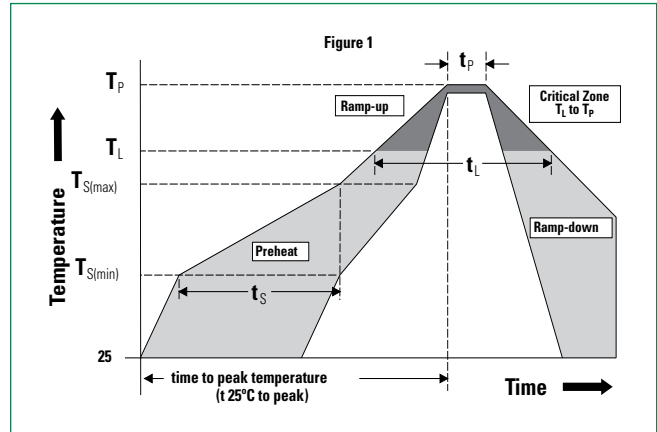

Physical Specifications

| | |
|------------------------|---|
| Lead Material | Copper Alloy |
| Terminal Finish | 100% Matte-Tin Plated |
| Body Material | UL Recognized epoxy meeting flammability classification V-0 |

Environmental Specifications

| | |
|---|---|
| High Temp Voltage Blocking | 80% Rated V_{DRM} (V_{AC} Peak) +125°C or +150°C, 504 or 1008 hrs. MIL-STD-750 (Method 1040) JEDEC, JESD22-A-101 |
| Temp Cycling | -65°C to +150°C, 15 min. dwell, 10 up to 100 cycles. MIL-STD-750 (Method 1051) EIA/JEDEC, JESD22-A104 |
| Biased Temp & Humidity | 52 V_{DC} (+85°C) 85%RH, 504 up to 1008 hrs. EIA/JEDEC, JESD22-A-101 |
| High Temp Storage | +150°C 1008 hrs. MIL-STD-750 (Method 1031) JEDEC, JESD22-A-101 |
| Low Temp Storage | -65°C, 1008 hrs. |
| Thermal Shock | 0°C to +100°C, 5 min. dwell, 10 sec. transfer, 10 cycles. MIL-STD-750 (Method 1056) JEDEC, JESD22-A-106 |
| Autoclave (Pressure Cooker Test) | +121°C, 100%RH, 2atm, 24 up to 168 hrs. EIA/JEDEC, JESD22-A-102 |
| Resistance to Solder Heat | +260°C, 30 secs. MIL-STD-750 (Method 2031) |
| Moisture Sensitivity Level | 85%RH, +85°C, 168 hrs., 3 reflow cycles (+260°C Peak). JEDEC-J-STD-020, Level 1 |

Part Marking

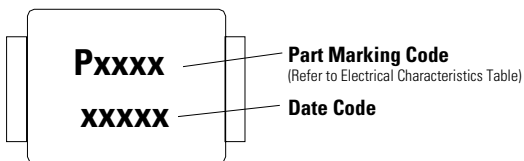

Dimensions – DO-214AA

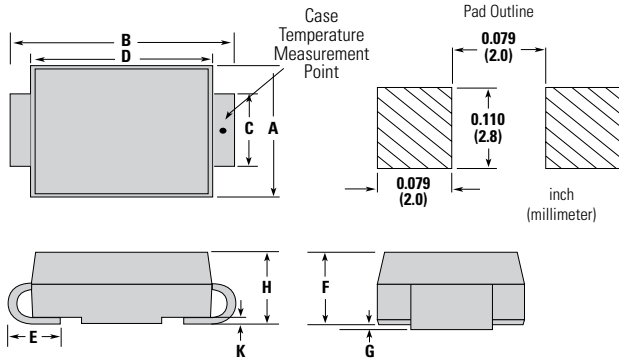

| Dimensions | Inches | | Millimeters | |
|------------|--------|-------|-------------|------|
| | Min | Max | Min | Max |
| A | 0.130 | 0.156 | 3.30 | 3.95 |
| B | 0.201 | 0.220 | 5.10 | 5.60 |
| C | 0.077 | 0.087 | 1.95 | 2.20 |
| D | 0.159 | 0.181 | 4.05 | 4.60 |
| E | 0.030 | 0.063 | 0.75 | 1.60 |
| F | 0.075 | 0.096 | 1.90 | 2.45 |
| G | 0.002 | 0.008 | 0.05 | 0.20 |
| H | 0.077 | 0.104 | 1.95 | 2.65 |
| K | 0.006 | 0.016 | 0.15 | 0.41 |

Part Numbering

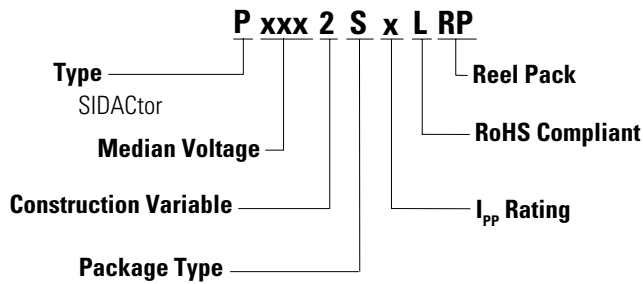

Packing Options

| Package Type | Description | Quantity | Added Suffix | Industry Standard |
|--------------|----------------------|----------|--------------|-------------------|
| S | DO-214AA Tape & Reel | 2500 | RP | EIA-481-D |

Tape and Reel Specification – DO-214AA

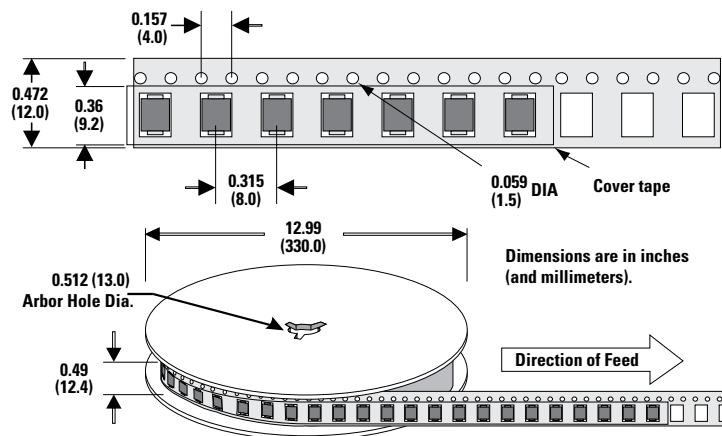

Данный компонент на территории Российской Федерации

Вы можете приобрести в компании MosChip.

Для оперативного оформления запроса Вам необходимо перейти по данной ссылке:

<http://moschip.ru/get-element>

Вы можете разместить у нас заказ для любого Вашего проекта, будь то серийное производство или разработка единичного прибора.

В нашем ассортименте представлены ведущие мировые производители активных и пассивных электронных компонентов.

Нашей специализацией является поставка электронной компонентной базы двойного назначения, продукции таких производителей как XILINX, Intel (ex.ALTERA), Vicor, Microchip, Texas Instruments, Analog Devices, Mini-Circuits, Amphenol, Glenair.

Сотрудничество с глобальными дистрибьюторами электронных компонентов, предоставляет возможность заказывать и получать с международных складов практически любой перечень компонентов в оптимальные для Вас сроки.

На всех этапах разработки и производства наши партнеры могут получить квалифицированную поддержку опытных инженеров.

Система менеджмента качества компании отвечает требованиям в соответствии с ГОСТ Р ИСО 9001, ГОСТ РВ 0015-002 и ЭС РД 009

Офис по работе с юридическими лицами:

105318, г.Москва, ул.Щербаковская д.3, офис 1107, 1118, ДЦ «Щербаковский»

Телефон: +7 495 668-12-70 (многоканальный)

Факс: +7 495 668-12-70 (доб.304)

E-mail: info@moschip.ru

Skype отдела продаж:

moschip.ru

moschip.ru_4

moschip.ru_6

moschip.ru_9