

PROD NO
SEE NOTE

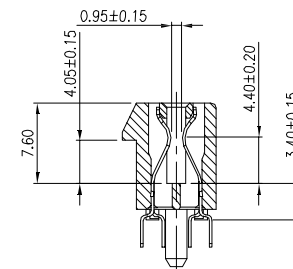

SECTION A-A

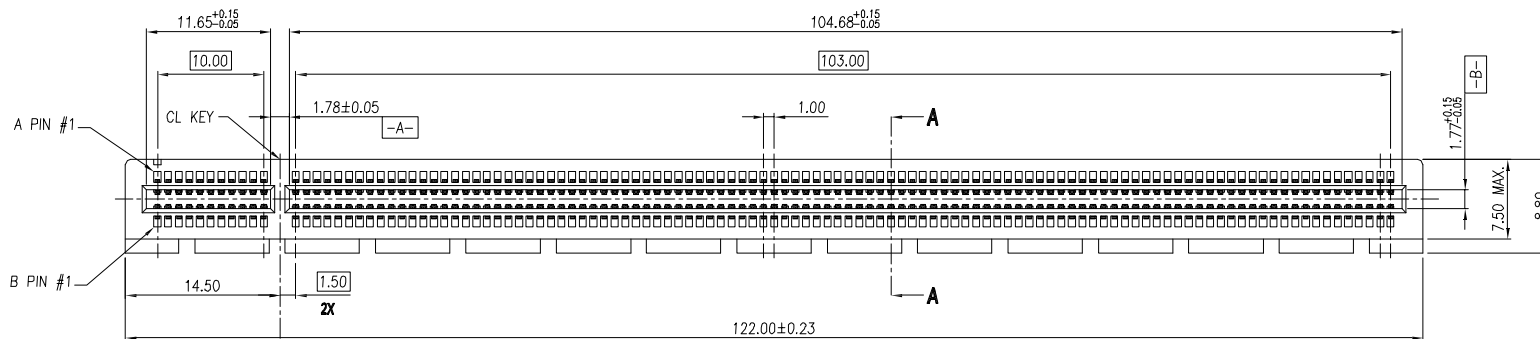
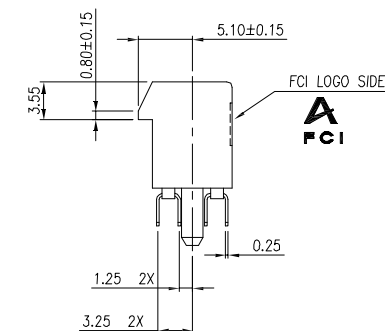

A

A

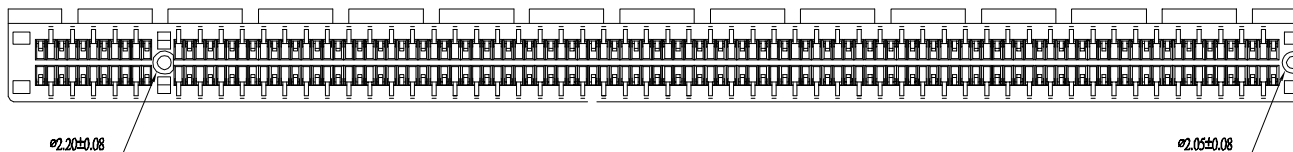
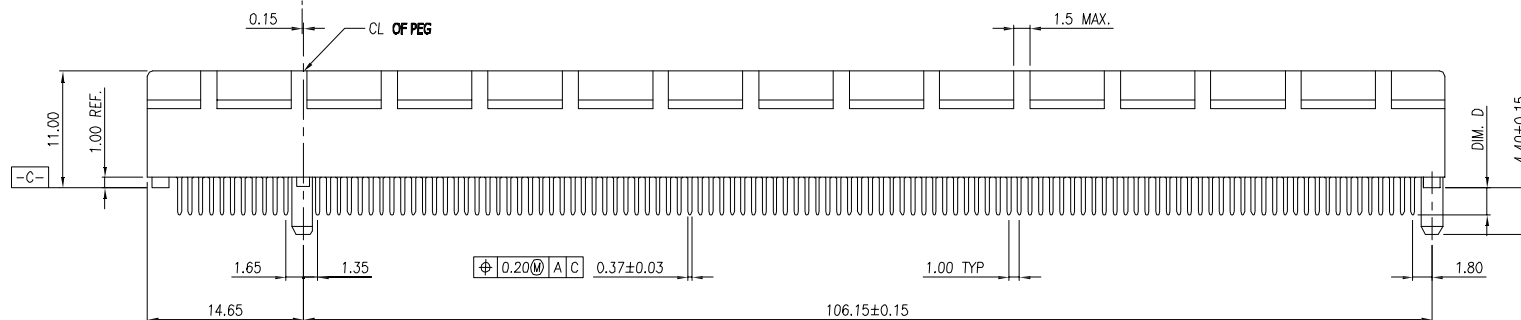

B

B

mat'l. code				tolerances unless otherwise specified				CUSTOMER COPY		 www.fciconnect.com		
ltr	ecn no	dr	date	linear	.X ±.38		projection	title		 MM	PCI-E 230P CARD EDGE GEN3 	
A	T06-0076	J.H	11/30/05		.XX ±.25			product family				code
B	ELX-DG-2161-1	S T	05/27/15		.XXX ±.10			PCI				
				angles	0° ±2'		scale		sheet			
				dr	STONE LI	05/27/15	A4		10063960	1 of 4		
				enrg	STONE LI	05/27/15	N/A					
				chr	/	/						
				appd	PM ZHENG	05/27/15						
sheet index	revision sheet	B	B	B	B							
		1	2	3	4							

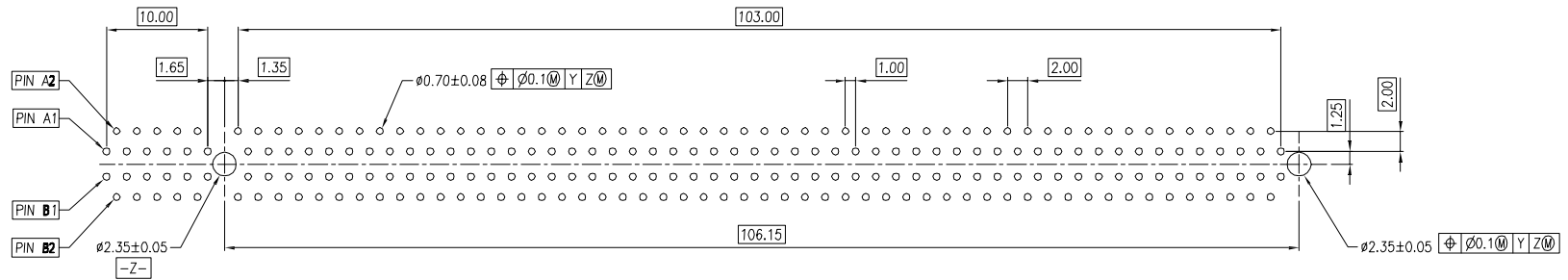

← I/O PANEL DIRECTION

RECOMMENDED FOOTPRINT

[-Y-]
PCB SURFACE

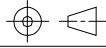
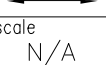
mat'l. code				tolerances unless otherwise specified				CUSTOMER COPY		 www.fciconnect.com	
ltr	ecn no	dr	date	linear	.X ±.38	projection	title				
					.XX ±.25		PCI-E 230P CARD EDGE GEN3				
				angles	.XXX ±.10						
				dr	STONE LI 05/27/15	MM	product family		PCI	code	
				enr	STONE LI 05/27/15		size		dwg no	—	
				chr	/ /		scale	A4		10063960	sheet
				appd	PM ZHENG 05/27/15	N/A				2 of 4	
sheet index	revision sheet										

cage code
22526

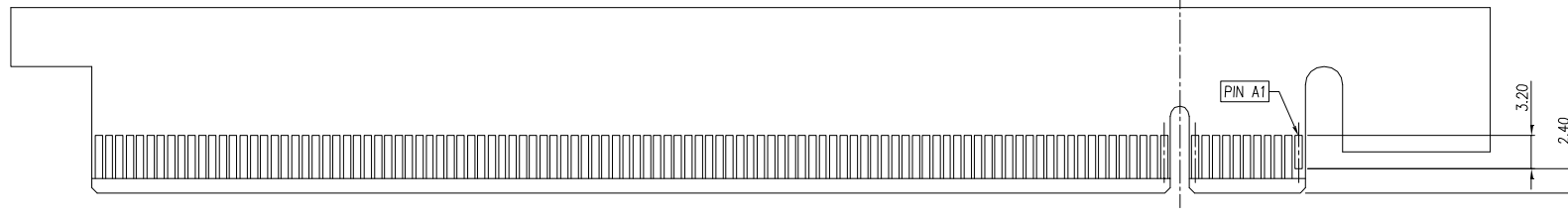

I/O PANEL DIRECTION SECONDARY (SOLDER) SIDE →

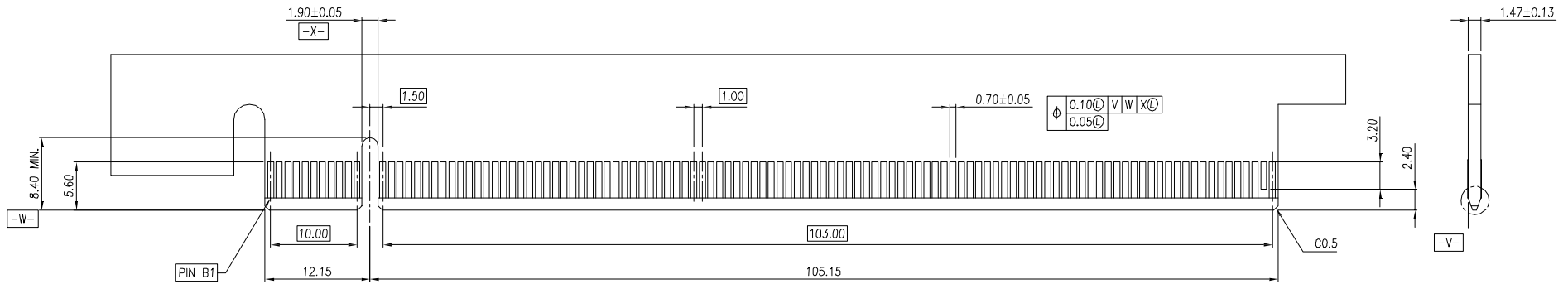

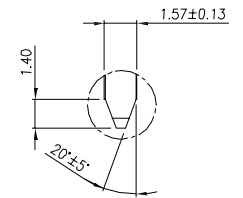

← I/O PANEL DIRECTION PRIMARY (COMPONENT) SIDE

ADD-IN CARD EDGE-FINGER DIMENSIONS



SCALE 2:1

mat'l. code				tolerances unless otherwise specified			CUSTOMER COPY		 www.fciconnect.com		
ltr	ecn no	dr	date	linear	.X ±.38		projection	title			
					.XX ±.25			 MM	PCI-E 230P CARD EDGE GEN3		
					.XXX ±.10				product family PCI code		
				angles	0° ±2°			size		sheet	
				dr	STONE LI	05/27/15		PCI		3 of 4	
				engr	STONE LI	05/27/15		size			
				chr	/	/		scale			
				appd	PM ZHENG	05/27/15		A4			
sheet index		revision sheet						10063960			
									cage code		
									22526		

NOTES:

1.MATERIAL:

HOUSING: THERMOPLASTIC WITH GLASS FIBER, UL94V-0, COLOR IN BLACK.

CONTACTS: COPPER ALLOY.

2.FINISH:

CONTACTS: GOLD PLATING ON CONTACT AREA, 100u"MIN. TIN/LEAD OR MATTE TIN (LEAD FREE OPTION) PLATING ON SOLDER TAILS, 50u"MIN. NICKEL UNDERPLATING OVER ALL.

3. DURABILITY: 50 CYCLES.

4. RoHS COMPATIBLE PRODUCT SPECIFICATIONS

a. PLATING: "LF" MEANS THE PRODUCT IS LEAD FREE, 2.5um min. MATTE PURE TIN OVER 1.27um MIN. NICKEL UNDERPLATE.

b. MANUFACTURING PROCESS COMPATIBILITY: THE HOUSING WILL WITHSTAND EXPOSURE TO 260C±5C SOLDER BATH TEMPERATURE FOR 5 SECONDS IN A WAVE SOLDER APPLICATION WITH A 1.60MM THICK CIRCUIT BOARD.

PRODUCT NUMBER CODE
10063960 - X X X X 0 T L F

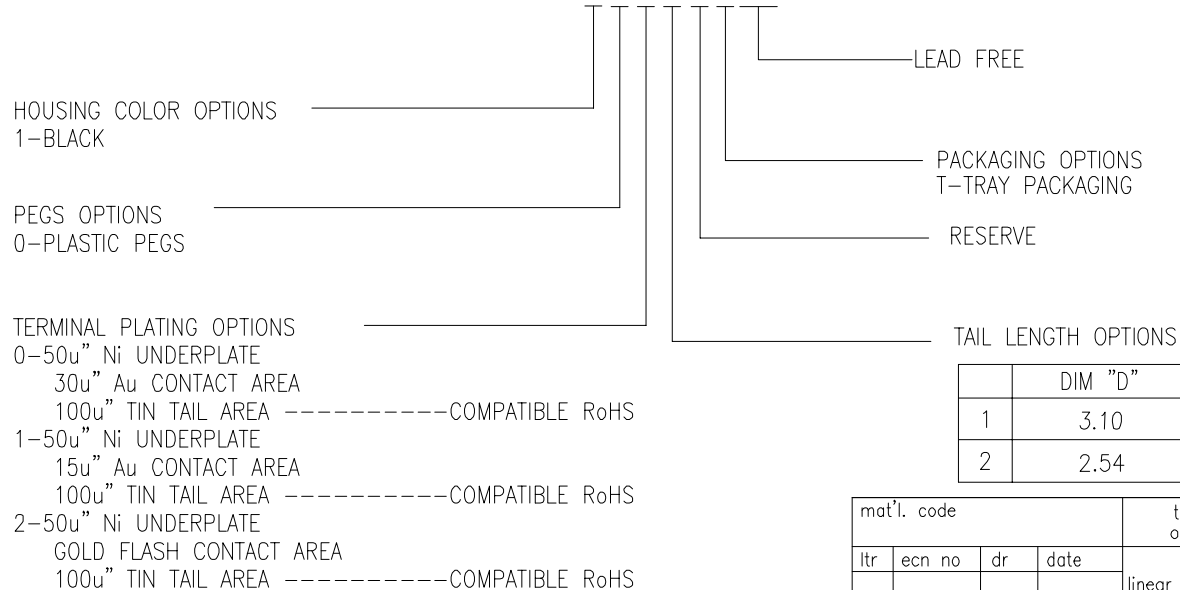

	DIM "D"	SUGGESTED PCB THICKNESS
1	3.10	2.36±0.10
2	2.54	1.56±0.10

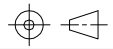
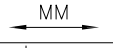
mat'l. code				tolerances unless otherwise specified		CUSTOMER COPY		 www.fciconnect.com	
ltr	ecn no	dr	date	linear	.X ±.38		projection	title	
					.XX ±.25			PCI-E 230P CARD EDGE GEN3	
					.XXX ±.10				
				angles	0° ±2°		 MM	product family	
				dr	STONE LI	05/27/15		PCI	
				engr	STONE LI	05/27/15		code	
				chr	/	/		-	
				appd	PM ZHENG	05/27/15	scale	sheet	
							N/A	4 of 4	
sheet index		revision sheet							

cage code
22526

Данный компонент на территории Российской Федерации

Вы можете приобрести в компании MosChip.

Для оперативного оформления запроса Вам необходимо перейти по данной ссылке:

<http://moschip.ru/get-element>

Вы можете разместить у нас заказ для любого Вашего проекта, будь то серийное производство или разработка единичного прибора.

В нашем ассортименте представлены ведущие мировые производители активных и пассивных электронных компонентов.

Нашей специализацией является поставка электронной компонентной базы двойного назначения, продукции таких производителей как XILINX, Intel (ex.ALTERA), Vicor, Microchip, Texas Instruments, Analog Devices, Mini-Circuits, Amphenol, Glenair.

Сотрудничество с глобальными дистрибьюторами электронных компонентов, предоставляет возможность заказывать и получать с международных складов практически любой перечень компонентов в оптимальные для Вас сроки.

На всех этапах разработки и производства наши партнеры могут получить квалифицированную поддержку опытных инженеров.

Система менеджмента качества компании отвечает требованиям в соответствии с ГОСТ Р ИСО 9001, ГОСТ РВ 0015-002 и ЭС РД 009

Офис по работе с юридическими лицами:

105318, г.Москва, ул.Щербаковская д.3, офис 1107, 1118, ДЦ «Щербаковский»

Телефон: +7 495 668-12-70 (многоканальный)

Факс: +7 495 668-12-70 (доб.304)

E-mail: info@moschip.ru

Skype отдела продаж:

moschip.ru

moschip.ru_4

moschip.ru_6

moschip.ru_9