

Slide Potentiometer

Model PSxxM / PSxxL



Features:

- Molded element
- 100,000 cycle life
- Metal or plastic shaft options
- With/without LED illumination
- With/without dust cover
- RoHS compliant

Model Styles Available

| | |
|-----------------------|-------|
| Dual Gang Without LED | PSxxM |
| Single Gang With LED | PSxxL |

Electrical

| | |
|---|---|
| Resistance Range, Ohms | 500 -1M |
| Standard Resistance Tolerance | ± 20% |
| Resistance Tapers | A,B,C |
| Residual Resistance | Terminals 1 to 2: Less than 10 ohms Terminals 2 to 3: Less than 30 ohms |
| Input Voltage, Maximum | Linear B taper: 200 Vac Other tapers: 150 Vac |
| Power rating, Watts (Single Unit / Dual Unit) | Linear B taper: 20mm: 0.1W / 0.05W, 30mm: 0.2W / 0.1W 45mm: 0.25W / 0.125W, 60mm: 0.2W / 0.2W Other tapers: 20mm: 0.05W / 0.025W, 30mm: 0.1W / 0.05W 45mm: 0.125W / 0.06W, 60mm: 0.1W / 0.1W |
| Dielectric Strength | 300Vac, 1 minute |
| Insulation Resistance, Minimum | 10M ohms at 250Vdc/ 1 minute |
| Sliding Noise | Less than 100mV |
| Gang Error | ±3dB (-40dB to 0dB) |

Mechanical

| | |
|-------------------------------|---------------|
| Static Stop Strength, Minimum | 5.0 Kg/cm |
| Operating Force | 10gf to 100gf |
| Detent Slip-out force | 30gf to 200gf |

Durability

| | |
|--------------|----------------|
| Sliding Life | 100,000 cycles |
|--------------|----------------|

General Note

TT Electronics reserves the right to make changes in product specification without notice or liability. All information is subject to TT Electronics' own data and is considered accurate at time of going to print.

TT Electronics | BI Technologies
4200 Bonita Place, Fullerton, CA USA 92835 | Ph: +1 714 447 2345
www.ttelectronics.com | sensors@ttelectronics.com

Slide Potentiometer

Model PSxxM / PSxxL



Ordering

Model PSxxM (Without LED)

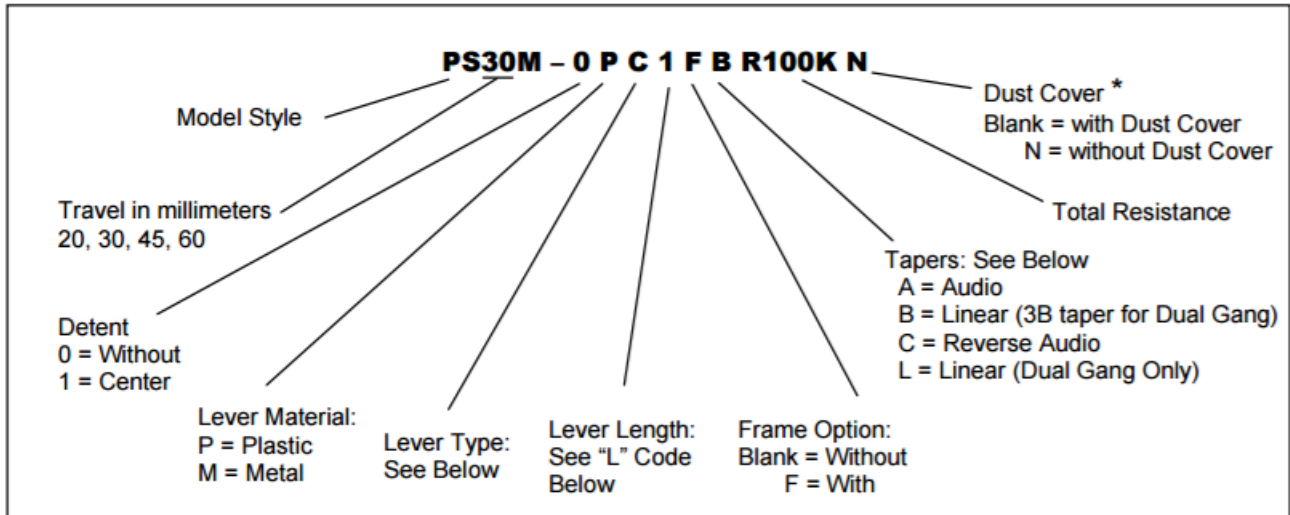

Model PSxxL (With LED)

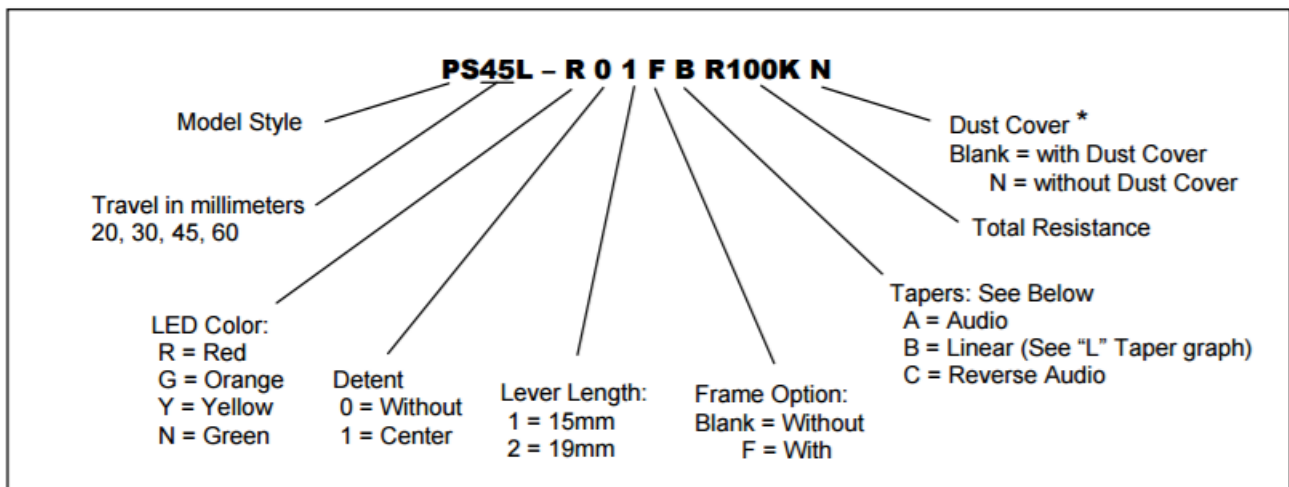

Standard Resistance Values, ohms

| | | | | | | | | | | |
|-----|----|----|----|-----|-----|-----|------|------|------|-------|
| 500 | 1K | 2K | 5K | 10K | 20K | 50K | 100K | 200K | 500K | 1 MEG |
|-----|----|----|----|-----|-----|-----|------|------|------|-------|

General Note

TT Electronics reserves the right to make changes in product specification without notice or liability. All information is subject to TT Electronics' own data and is considered accurate at time of going to print.

Slide Potentiometer

Model PSxxM / PSxxL



Tapers

For Dual Gang units ONLY, the Standard Taper is a 3B taper
If Linear Taper is desired, use "L" taper option



General Note

TT Electronics reserves the right to make changes in product specification without notice or liability. All information is subject to TT Electronics' own data and is considered accurate at time of going to print.

TT Electronics | BI Technologies
4200 Bonita Place, Fullerton, CA USA 92835 | Ph: +1 714 447 2345
www.ttelectronics.com | sensors@ttelectronics.com

Outline Drawings

Plastic Lever Types (For PSxxM Only)

| E-Type | | B-Type | | C-Type | | D-Type | | |
|--------|-----|--------|----|--------|-------|--------|----------|--|
| | | | | | | | | |
| L | 5.0 | L | 15 | L | 10 15 | L | 10 15 20 | |
| CODE | 1 | CODE | 1 | CODE | 1 2 | CODE | 1 2 3 | |

Dust Cover option not offered for levers less than 10 mm in length

Metal Lever Types (For PSxxM Only)

| D-Type | | | | C-Type | | | | E-Type | | |
|--------|----|----|----|--------|---|----|----|--------|------|---|
| | | | | | | | | | | |
| L | 15 | 20 | 25 | F | 5 | 10 | 10 | L | 7.6 | |
| CODE | 1 | 2 | 3 | CODE | 1 | 2 | 3 | 4 | CODE | 1 |

*** Dust Cover option not offered for levers less than 10 mm in length**

General Note

TT Electronics reserves the right to make changes in product specification without notice or liability. All information is subject to TT Electronics' own data and is considered accurate at time of going to print.

TT Electronics | BI Technologies
4200 Bonita Place, Fullerton, CA USA 92835 | Ph: +1 714 447 2345
www.ttelectronics.com | sensors@ttelectronics.com

Slide Potentiometer

Model PSxxM / PSxxL



Outline Drawings

Model PSxxM (Without LED)

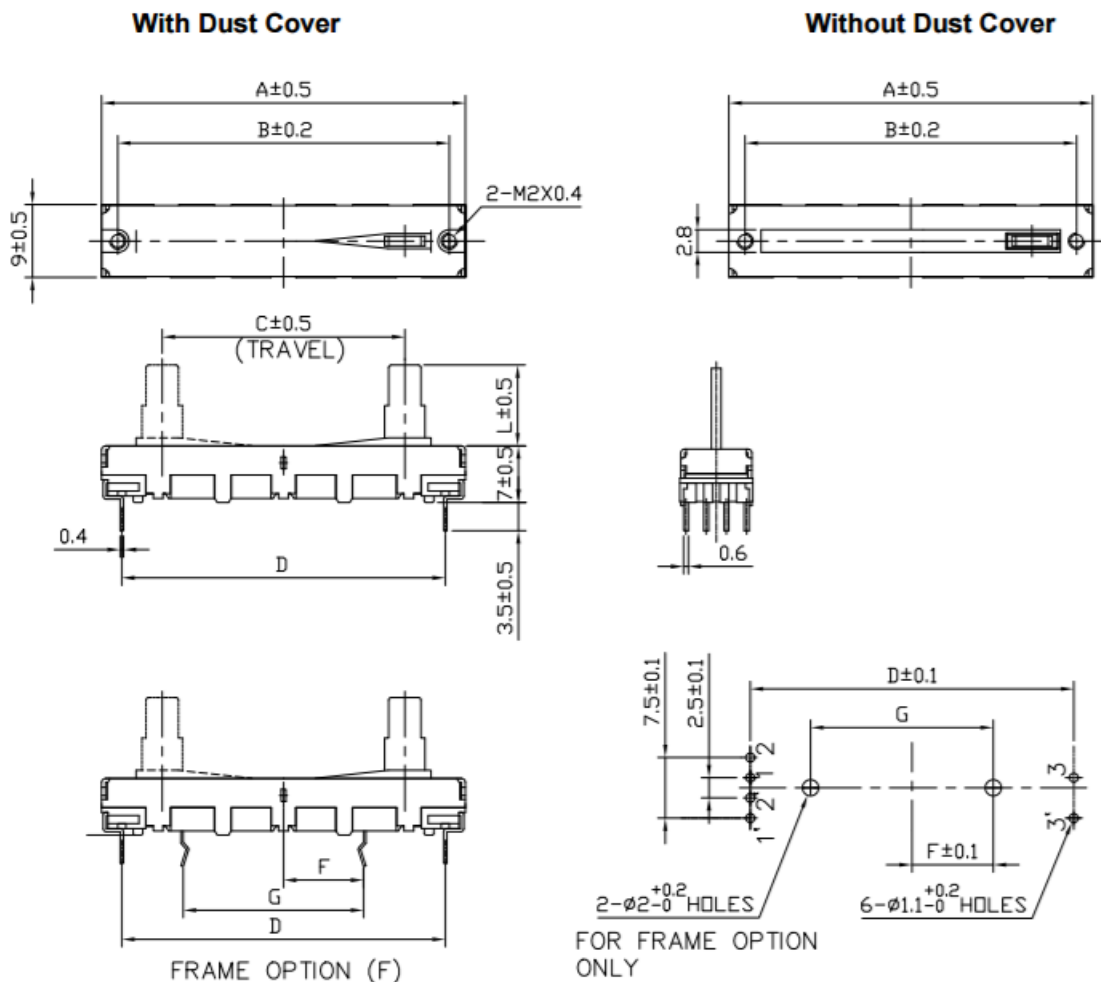

For PSxxM and PSxxL

| MODEL | A | B | C | D | F | G |
|-------------|----|----|----|----|------|------|
| PS20M PS20L | 35 | 31 | 20 | 30 | 5 | 12.5 |
| PS30M PS30L | 45 | 41 | 30 | 40 | 10 | 22.5 |
| PS45M PS45L | 60 | 56 | 45 | 55 | 15 | 32.5 |
| PS60M PS60L | 75 | 71 | 60 | 70 | 22.5 | 47.5 |

General Note

TT Electronics reserves the right to make changes in product specification without notice or liability. All information is subject to TT Electronics' own data and is considered accurate at time of going to print.

TT Electronics | BI Technologies
 4200 Bonita Place, Fullerton, CA USA 92835 | Ph: +1 714 447 2345
 www.ttelectronics.com | sensors@ttelectronics.com

Slide Potentiometer

Model PSxxM / PSxxL



Outline Drawings

Model PSxxL (With LED)

With Dust Cover

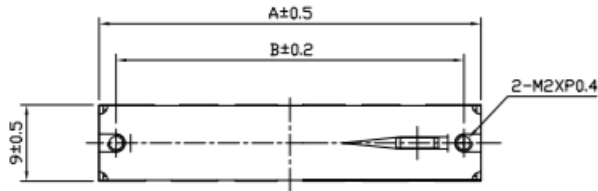

Without Dust Cover

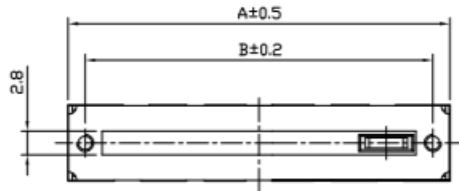

| | | |
|------|----|----|
| L | 15 | 19 |
| CODE | 1 | 2 |

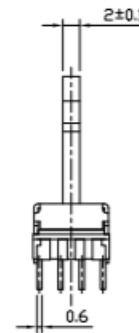

FRAME OPTION (F)

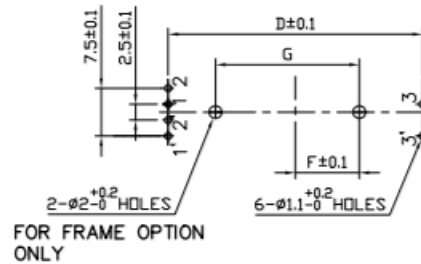

PSxxL (Single gang with LED)

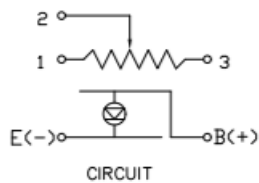

PSxxM (Dual gang)

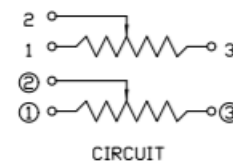

General Note

TT Electronics reserves the right to make changes in product specification without notice or liability. All information is subject to TT Electronics' own data and is considered accurate at time of going to print.

TT Electronics | BI Technologies
4200 Bonita Place, Fullerton, CA USA 92835 | Ph: +1 714 447 2345
www.ttelectronics.com | sensors@ttelectronics.com

Данный компонент на территории Российской Федерации

Вы можете приобрести в компании MosChip.

Для оперативного оформления запроса Вам необходимо перейти по данной ссылке:

<http://moschip.ru/get-element>

Вы можете разместить у нас заказ для любого Вашего проекта, будь то серийное производство или разработка единичного прибора.

В нашем ассортименте представлены ведущие мировые производители активных и пассивных электронных компонентов.

Нашей специализацией является поставка электронной компонентной базы двойного назначения, продукции таких производителей как XILINX, Intel (ex.ALTERA), Vicor, Microchip, Texas Instruments, Analog Devices, Mini-Circuits, Amphenol, Glenair.

Сотрудничество с глобальными дистрибьюторами электронных компонентов, предоставляет возможность заказывать и получать с международных складов практически любой перечень компонентов в оптимальные для Вас сроки.

На всех этапах разработки и производства наши партнеры могут получить квалифицированную поддержку опытных инженеров.

Система менеджмента качества компании отвечает требованиям в соответствии с ГОСТ Р ИСО 9001, ГОСТ РВ 0015-002 и ЭС РД 009

Офис по работе с юридическими лицами:

105318, г.Москва, ул.Щербаковская д.3, офис 1107, 1118, ДЦ «Щербаковский»

Телефон: +7 495 668-12-70 (многоканальный)

Факс: +7 495 668-12-70 (доб.304)

E-mail: info@moschip.ru

Skype отдела продаж:

moschip.ru

moschip.ru_4

moschip.ru_6

moschip.ru_9