

# Slide Potentiometer

Model PSxxM / PSxxL



## Features:

- Molded element
- 100,000 cycle life
- Metal or plastic shaft options
- With/without LED illumination
- With/without dust cover
- RoHS compliant

## Model Styles Available

Dual Gang Without LED	PSxxM
Single Gang With LED	PSxxL

## Electrical

Resistance Range, Ohms	500 -1M
Standard Resistance Tolerance	± 20%
Resistance Tapers	A,B,C
Residual Resistance	Terminals 1 to 2: Less than 10 ohms Terminals 2 to 3: Less than 30 ohms
Input Voltage, Maximum	Linear B taper: 200 Vac    Other tapers: 150 Vac
Power rating, Watts (Single Unit / Dual Unit)	<b>Linear B taper:</b> 20mm: 0.1W / 0.05W, 30mm: 0.2W / 0.1W 45mm: 0.25W / 0.125W, 60mm: 0.2W / 0.2W <b>Other tapers:</b> 20mm: 0.05W / 0.025W, 30mm: 0.1W / 0.05W 45mm: 0.125W / 0.06W, 60mm: 0.1W / 0.1W
Dielectric Strength	300Vac, 1 minute
Insulation Resistance, Minimum	10M ohms at 250Vdc/ 1 minute
Sliding Noise	Less than 100mV
Gang Error	±3dB (-40dB to 0dB)

## Mechanical

Static Stop Strength, Minimum	5.0 Kg/cm
Operating Force	10gf to 100gf
Detent Slip-out force	30gf to 200gf

## Durability

Sliding Life	100,000 cycles
--------------	----------------

### General Note

TT Electronics reserves the right to make changes in product specification without notice or liability. All information is subject to TT Electronics' own data and is considered accurate at time of going to print.

TT Electronics | BI Technologies  
4200 Bonita Place, Fullerton, CA USA 92835 | Ph: +1 714 447 2345  
www.ttelectronics.com | sensors@ttelectronics.com

# Slide Potentiometer

Model PSxxM / PSxxL



## Ordering

### Model PSxxM (Without LED)

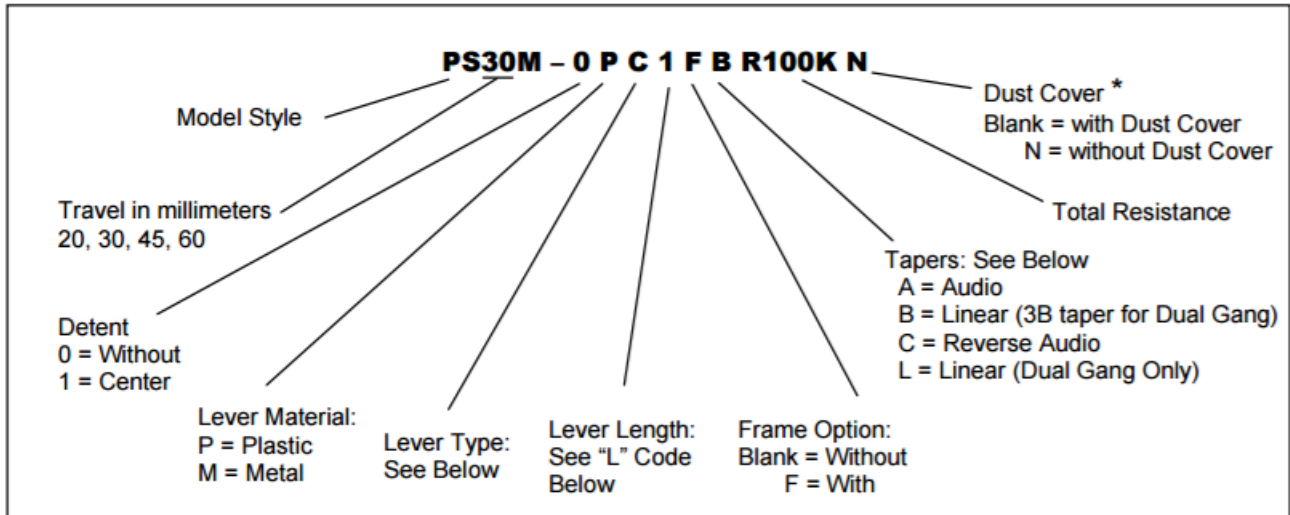

### Model PSxxL (With LED)

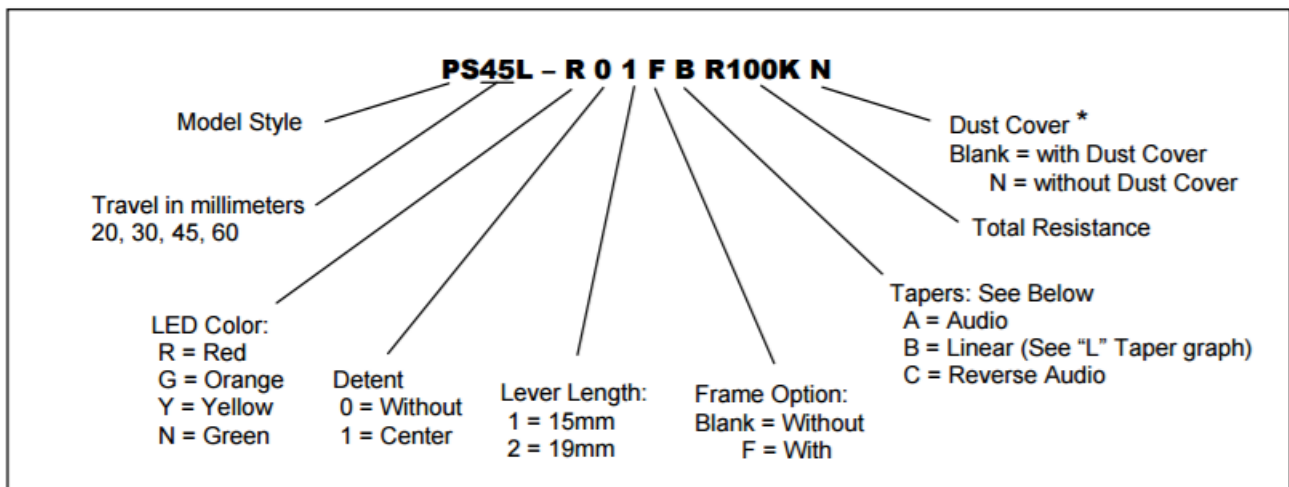

## Standard Resistance Values, ohms

500	1K	2K	5K	10K	20K	50K	100K	200K	500K	1 MEG
-----	----	----	----	-----	-----	-----	------	------	------	-------

#### General Note

TT Electronics reserves the right to make changes in product specification without notice or liability. All information is subject to TT Electronics' own data and is considered accurate at time of going to print.

# Slide Potentiometer

Model PSxxM / PSxxL



## Tapers

For Dual Gang units ONLY, the Standard Taper is a 3B taper  
If Linear Taper is desired, use "L" taper option



### General Note

TT Electronics reserves the right to make changes in product specification without notice or liability. All information is subject to TT Electronics' own data and is considered accurate at time of going to print.

TT Electronics | BI Technologies  
4200 Bonita Place, Fullerton, CA USA 92835 | Ph: +1 714 447 2345  
www.ttelectronics.com | sensors@ttelectronics.com

### Outline Drawings

#### Plastic Lever Types (For PSxxM Only)

E-Type		B-Type		C-Type		D-Type		
L	5.0	L	15	L	10 15	L	10 15 20	
CODE	1	CODE	1	CODE	1 2	CODE	1 2 3	

**Dust Cover option not offered for levers less than 10 mm in length**

#### Metal Lever Types (For PSxxM Only)

D-Type				C-Type				E-Type		
L	15	20	25	F	5	10	10	L	7.6	
CODE	1	2	3	CODE	1	2	3	4	CODE	1

**\* Dust Cover option not offered for levers less than 10 mm in length**

#### General Note

TT Electronics reserves the right to make changes in product specification without notice or liability. All information is subject to TT Electronics' own data and is considered accurate at time of going to print.

TT Electronics | BI Technologies  
4200 Bonita Place, Fullerton, CA USA 92835 | Ph: +1 714 447 2345  
www.ttelectronics.com | sensors@ttelectronics.com

# Slide Potentiometer

Model PSxxM / PSxxL



## Outline Drawings

### Model PSxxM (Without LED)

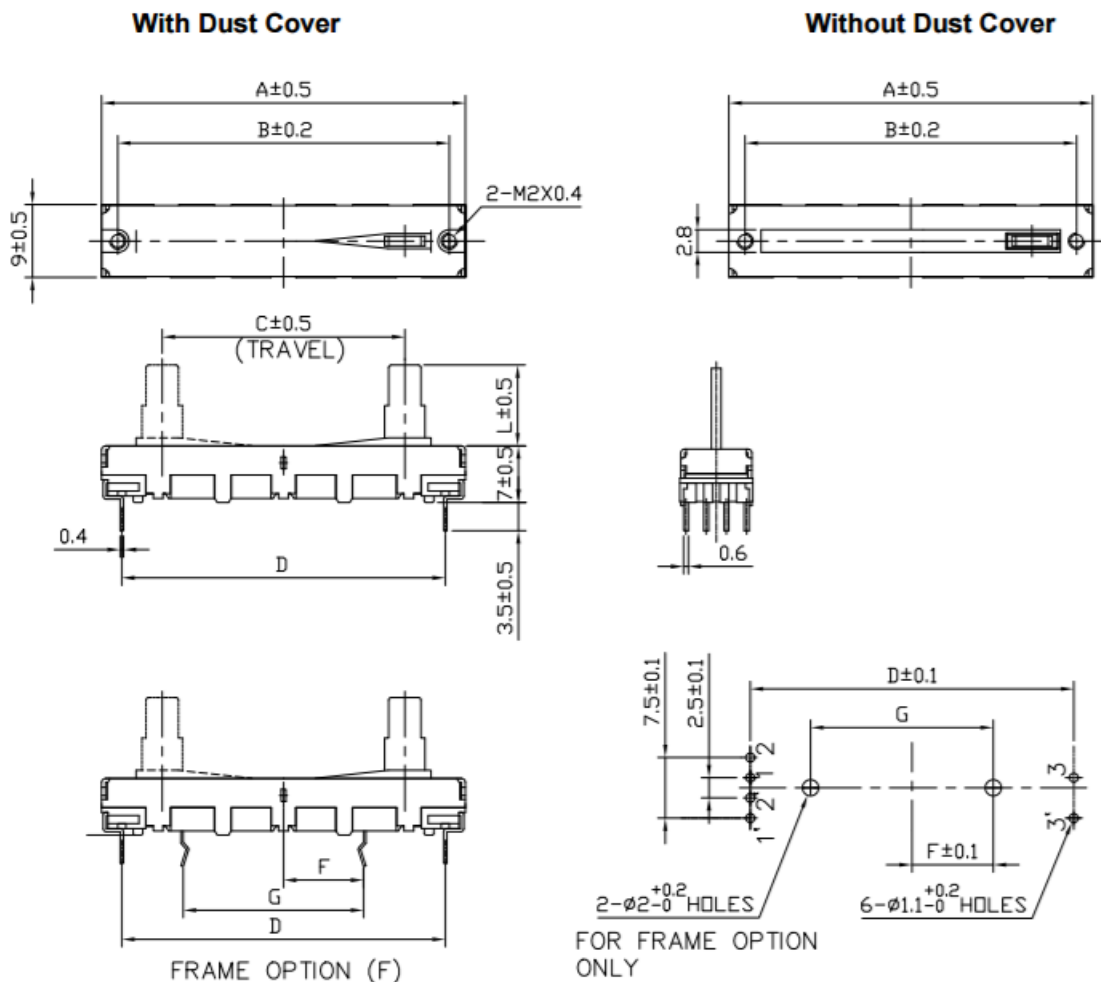

### For PSxxM and PSxxL

MODEL	A	B	C	D	F	G
PS20M PS20L	35	31	20	30	5	12.5
PS30M PS30L	45	41	30	40	10	22.5
PS45M PS45L	60	56	45	55	15	32.5
PS60M PS60L	75	71	60	70	22.5	47.5

#### General Note

TT Electronics reserves the right to make changes in product specification without notice or liability. All information is subject to TT Electronics' own data and is considered accurate at time of going to print.

TT Electronics | BI Technologies  
 4200 Bonita Place, Fullerton, CA USA 92835 | Ph: +1 714 447 2345  
 www.ttelectronics.com | sensors@ttelectronics.com

# Slide Potentiometer

Model PSxxM / PSxxL



## Outline Drawings

### Model PSxxL (With LED)

#### With Dust Cover

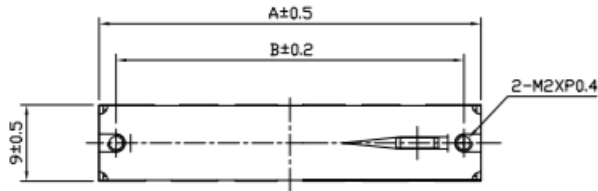

#### Without Dust Cover

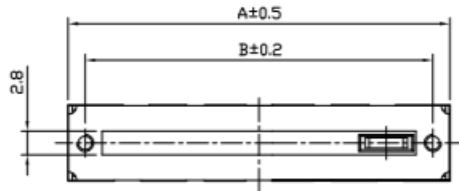

L	15	19
CODE	1	2

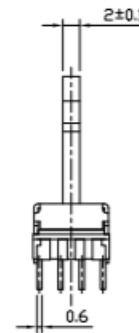

FRAME OPTION (F)

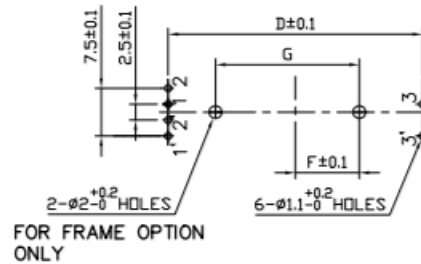

### PSxxL (Single gang with LED)

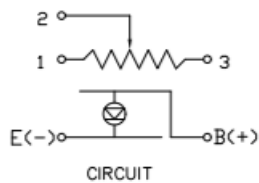

### PSxxM (Dual gang)

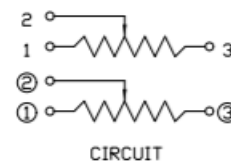

#### General Note

TT Electronics reserves the right to make changes in product specification without notice or liability. All information is subject to TT Electronics' own data and is considered accurate at time of going to print.

TT Electronics | BI Technologies  
4200 Bonita Place, Fullerton, CA USA 92835 | Ph: +1 714 447 2345  
www.ttelectronics.com | sensors@ttelectronics.com

## Данный компонент на территории Российской Федерации

### Вы можете приобрести в компании MosChip.

Для оперативного оформления запроса Вам необходимо перейти по данной ссылке:

<http://moschip.ru/get-element>

Вы можете разместить у нас заказ для любого Вашего проекта, будь то серийное производство или разработка единичного прибора.

В нашем ассортименте представлены ведущие мировые производители активных и пассивных электронных компонентов.

Нашей специализацией является поставка электронной компонентной базы двойного назначения, продукции таких производителей как XILINX, Intel (ex.ALTERA), Vicor, Microchip, Texas Instruments, Analog Devices, Mini-Circuits, Amphenol, Glenair.

Сотрудничество с глобальными дистрибьюторами электронных компонентов, предоставляет возможность заказывать и получать с международных складов практически любой перечень компонентов в оптимальные для Вас сроки.

На всех этапах разработки и производства наши партнеры могут получить квалифицированную поддержку опытных инженеров.

Система менеджмента качества компании отвечает требованиям в соответствии с ГОСТ Р ИСО 9001, ГОСТ РВ 0015-002 и ЭС РД 009

### Офис по работе с юридическими лицами:

105318, г.Москва, ул.Щербаковская д.3, офис 1107, 1118, ДЦ «Щербаковский»

Телефон: +7 495 668-12-70 (многоканальный)

Факс: +7 495 668-12-70 (доб.304)

E-mail: [info@moschip.ru](mailto:info@moschip.ru)

Skype отдела продаж:

moschip.ru

moschip.ru\_4

moschip.ru\_6

moschip.ru\_9