

3W or 5W Emitter on  
Standard MCPCB Option



















**LZ1-1xxx0x**



## Key Features

- Typical Thermal Resistance for MCPCB adds only 2°C/W
- Multiple mounting and attachment options
- MCPCB contains Zener Diode for ESD protection

## Available Products

Colors	3W Part Number	Emitter Link	5W Part Number	Emitter Link
Red	LZ1-10R103		LZ1-10R105	
Deep Red	n/a		LZ1-10R205	
Green	LZ1-10G103		LZ1-10G105	
Blue	LZ1-10B203		LZ1-10B205	
Amber	LZ1-10A103		LZ1-10A105	
Cool White	LZ1-10CW03		LZ1-10CW05	
Neutral White	LZ1-10NW03		LZ1-10NW05	
Warm White	LZ1-10WW03		LZ1-10WW05	
Dental Blue	n/a		LZ1-10DB05	
UV	n/a		LZ1-10UA05	

[Click on Emitter Link for emitter data sheet.](#)

## Description

The LZ1-1xxx0x Standard MCPCB option provides a convenient method to mount LedEngin's 3W or 5W emitters. The six recessed features allow the use of M3 or #4 screws to attach the MCPCB to a heat sink. The MCPCB has three sets of "+" (Anode) and "-" (Cathode) solder pads for electrical connections. The MCPCB also contains a Zener diode for enhanced ESD protection.

## R $\theta_{J-B}$ Lookup Table

Table 1:

Product	Emitter R $\theta_{J-C}$	+	MPCPB R $\theta_{C-B}$	=	Emitter + MPCPB R $\theta_{J-B}$
3W	11°C/W	+	2°C/W	=	13°C/W
5W	5.5°C/W	+	2°C/W	=	7.5°C/W

Note for Table 1:

- R $\theta_{J-B}$  is the combined thermal resistance from the LED die junction to the Aluminum core on MPCPB (R $\theta_{J-C}$  + R $\theta_{C-B}$  = R $\theta_{J-B}$ ).

## Emitter on Standard MPCPB Dimensions (mm)

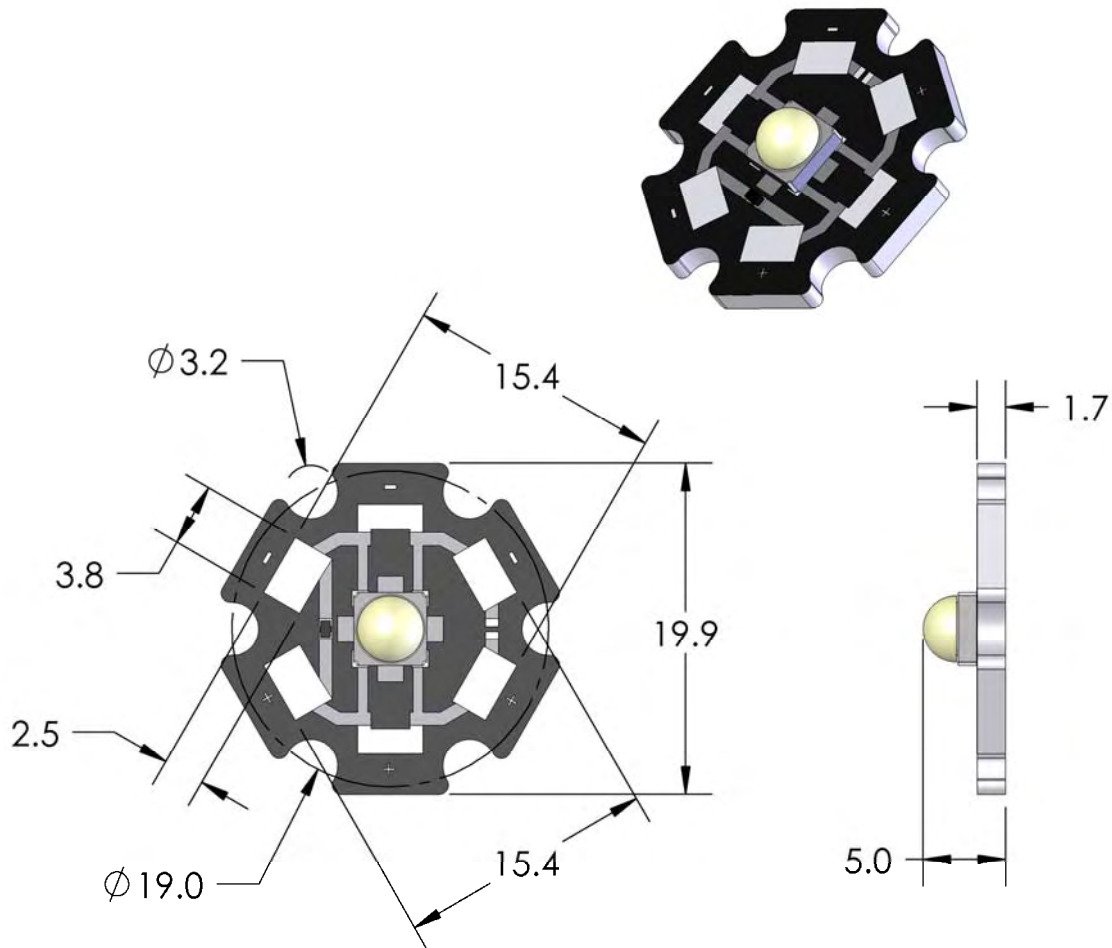

Figure 1: Standard MPCPB outline dimensions (mm).

Note for Figure 1:

- Unless otherwise noted, the tolerance =  $\pm 0.2$  mm.
- Slots in MPCPB are for M3 or #4 mounting screws.
- LedEngin recommends plastic washers to electrically insulate screws from solder pads and electrical traces.
- Electrical connection pads on MPCPB are labeled "+" for Anode and "-" for Cathode.
- LedEngin recommends using thermally conductive tape or adhesives when attaching MPCPB to a heat sink.

## Company Information

The LZ1-1xxx0x LED emitter on MCPCB is developed, manufactured, and marketed by LedEngin, Inc., located in Santa Clara, CA. LedEngin is a global leader in advanced high-power LED emitters and light-source modules. LedEngin provides total solutions from 3W to 15W in single packages with ultra-small footprints in all colors from Cool White, Neutral White, Warm White, Red, Green, Blue, Amber, RGB, RGBA, Deep Red, Dental Blue and UV. LedEngin supports customers to generate solid-state lighting designs that conserve natural resources. LedEngin is focused on differentiated Ultra High-Brightness LED solutions for diverse global markets using its patent-pending package designs and manufacturing processes. LedEngin offers catalog as well as full custom solutions to enable flexible system designs for its customers. LedEngin is dedicated to long-term win-win partnering with its customers and suppliers.

LedEngin reserves the right to make changes to improve performance without notice.

Please contact [Sales@ledengin.com](mailto:Sales@ledengin.com) or (408) 492-0620 for more information.

## Данный компонент на территории Российской Федерации

### Вы можете приобрести в компании MosChip.

Для оперативного оформления запроса Вам необходимо перейти по данной ссылке:

<http://moschip.ru/get-element>

Вы можете разместить у нас заказ для любого Вашего проекта, будь то серийное производство или разработка единичного прибора.

В нашем ассортименте представлены ведущие мировые производители активных и пассивных электронных компонентов.

Нашей специализацией является поставка электронной компонентной базы двойного назначения, продукции таких производителей как XILINX, Intel (ex.ALTERA), Vicor, Microchip, Texas Instruments, Analog Devices, Mini-Circuits, Amphenol, Glenair.

Сотрудничество с глобальными дистрибьюторами электронных компонентов, предоставляет возможность заказывать и получать с международных складов практически любой перечень компонентов в оптимальные для Вас сроки.

На всех этапах разработки и производства наши партнеры могут получить квалифицированную поддержку опытных инженеров.

Система менеджмента качества компании отвечает требованиям в соответствии с ГОСТ Р ИСО 9001, ГОСТ РВ 0015-002 и ЭС РД 009

### Офис по работе с юридическими лицами:

105318, г.Москва, ул.Щербаковская д.3, офис 1107, 1118, ДЦ «Щербаковский»

Телефон: +7 495 668-12-70 (многоканальный)

Факс: +7 495 668-12-70 (доб.304)

E-mail: [info@moschip.ru](mailto:info@moschip.ru)

Skype отдела продаж:

moschip.ru

moschip.ru\_4

moschip.ru\_6

moschip.ru\_9