



LTH3MM12V Series

3mm (T-1) Through Hole LED

Built in Resistor for 12VDC



LTH3MM12VFR4600 - Blue Water-Clear T-1 (3 mm) LED

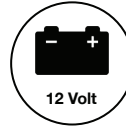

Applications

- Automotive
- Indoor and Outdoor Indication
- Industrial
- Appliances and Consumer Equipments
- Storage Servers
- Boats
- Railway
- Electronic Devices
- Residential and Landscape Lighting
- Infrastructure

Key Features

- Made with AlInGaP (Blue)
- Through-hole technology
- Integrated resistor for 12VDC operation
- With Flange
- Water-Clear Lens
- LED Bulb Size: 3mm (T-1), also available in 5mm (T-1 3/4)
- RoHS and REACH Compliant
- High-Brightness LED
- Available in 5 colors (red, green, white, blue and yellow)
- Viewing Angle: 30° (red, green, blue, yellow) and 35° (white)
- Moisture Sensitive Level (MSL): 2

Ordering Data

The LTH3MM12V Series is available in a range of standard features and options. To specify your LED, simply choose one option from each column.

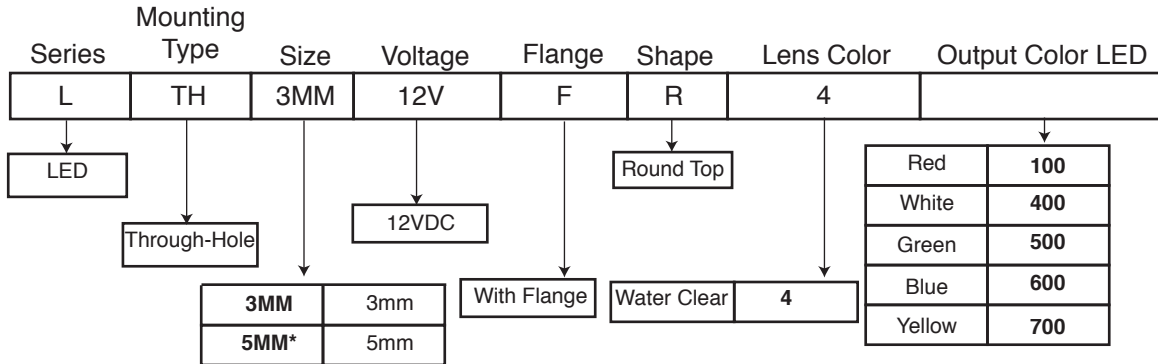

Part Numbers	Color
LTH3MM12VFR4100	Red
LTH3MM12VFR4400	White
LTH3MM12VFR4500	Green
LTH3MM12VFR4600	Blue
LTH3MM12VFR4700	Yellow

*For 5mm option, please consult LTH5MM12V Series' datasheet

Product Dimensions

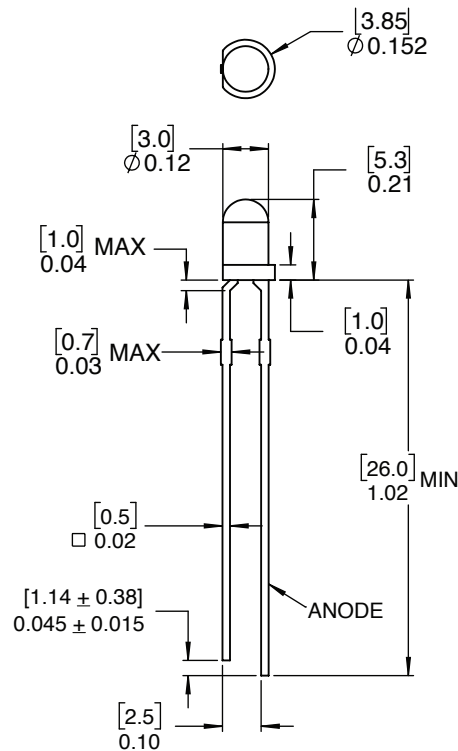

Notes:

1. All dimensions are in [millimeters] inches
2. Tolerance is $\pm[0.25]$ 0.01 unless otherwise noted.
3. The specifications, characteristics and technical data described in the datasheet are subject to change without prior notice

Product Dimensions

ABSOLUTE MAXIMUM RATINGS

(Ta=25°C)

Parameter	Symbol	Ratings	Unit
Peak Forward Current (duty 1/10 @ 1KHz)	I _{FP}	100	mA
Recommended Operating Current	I _{F(REC)}	20	mA
Power Dissipation	P _D	85	mW
Reverse Voltage	V _R	5	V
Electrostatic Discharge	ESD	200	V
Operating Temperature Range	T _{OPR}	-40~+85	°C
Storage Temperature Range	T _{STG}	-40~+100	°C
Lead Soldering Temperature Range 1.6mm (1/16 inch) from body	T _{SOL}	260°C for 5 seconds	

OPTICAL-ELECTRICAL CHARACTERISTICS

(Ta=25°C)

Parameter	Symbol	Test Condition	Min	Typ	Max	Unit
Luminous Intensity	I _v	I _F =12mA	800	1200	2000	mcd
Peak Emission Wavelength	λ _P		--	470	--	nm
Dominant Wavelength	λ _D		465	467	470	nm
Forward Voltage	V _F		11	12	13	V
Spectral Line Half-Width	Δλ		--	45	--	nm
Viewing Angle	2θ _{1/2}		--	30	--	deg
Reverse Current	I _R	V _R =5V	--	--	10	μA

Product Specifications

Typical Electrical-Optical Characteristic Curves

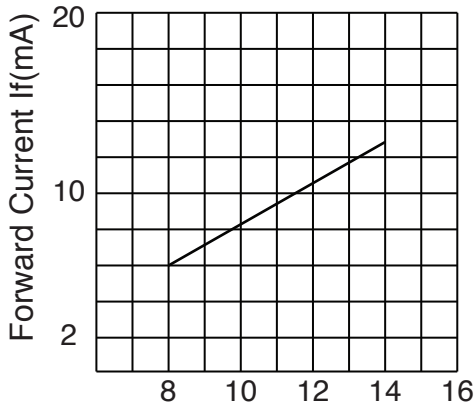

Forward Current vs. Forward Voltage

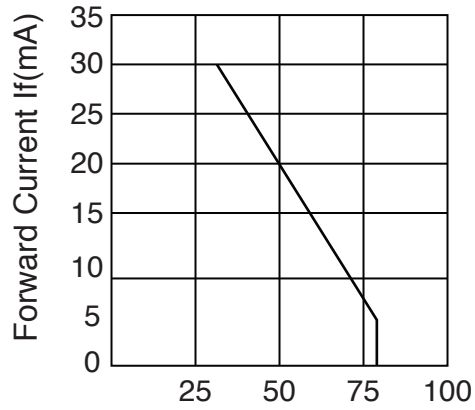

Forward Current Derating Curve

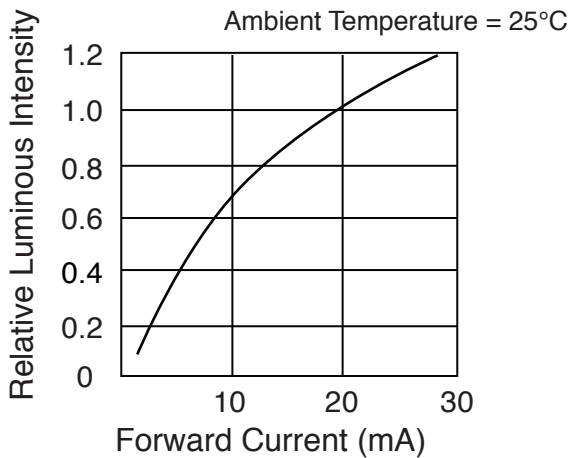

Luminous Intensity vs. Forward Current

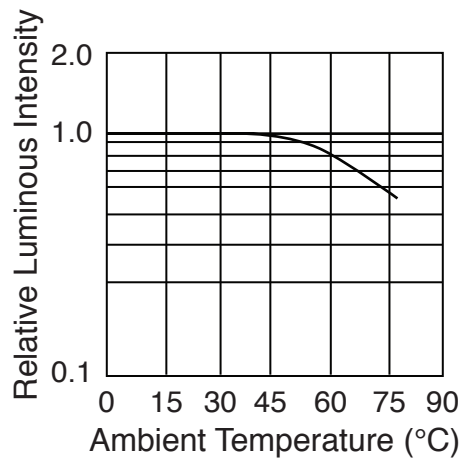

Luminous Intensity vs. Ambient Temperature

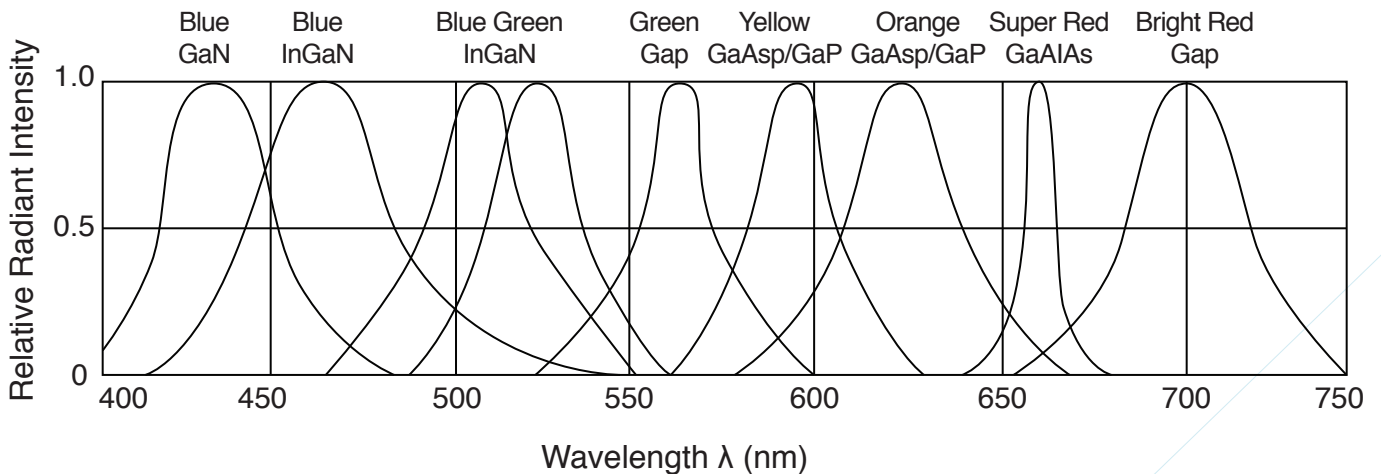

Relative Intensity vs. Wavelength

Application Notes

1. Storage

The Storage Temperature and RH are: 5°C ~ 30°C, RH 60% or less.

We suggest our customers use our products within a year.

If the moisture absorbent material (silica gel) has faded away or the LEDs exceeded the storage time, bake treat more than 24 hours at 60°C ±5°C.

2. Electrostatic Discharge (ESD)

Static electricity or surge voltage will damage the LEDs.

Recommendations: Use a conductive wrist band or anti-electrostatic glove when handling these LEDs. All devices, equipment and machinery must be properly grounded.

Work tables, storage racks, etc. should be properly grounded. In the event of a manual working in process, make sure the devices are well protected from ESD at any time.

3. Recommended Soldering Condition

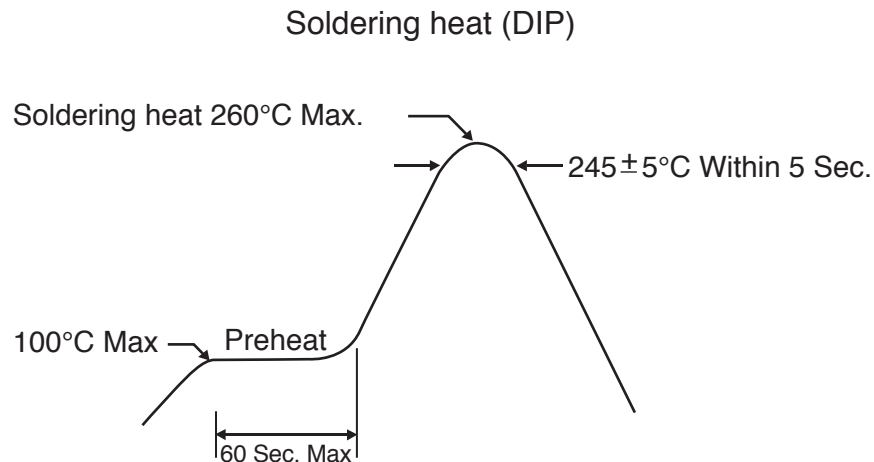

Temperature at tip of soldering iron: 350°C Max
Soldering time: 3 sec ±1 sec (once only)

Application Notes

4. Reflow Profile

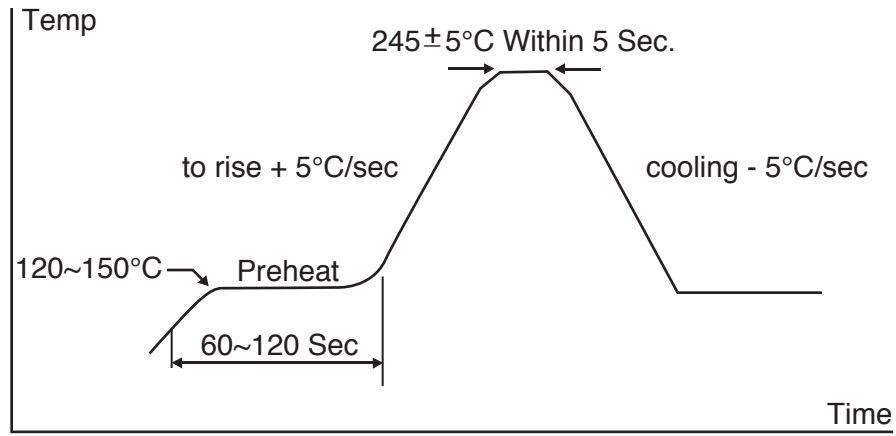

Compliances and Approvals



Данный компонент на территории Российской Федерации

Вы можете приобрести в компании MosChip.

Для оперативного оформления запроса Вам необходимо перейти по данной ссылке:

<http://moschip.ru/get-element>

Вы можете разместить у нас заказ для любого Вашего проекта, будь то серийное производство или разработка единичного прибора.

В нашем ассортименте представлены ведущие мировые производители активных и пассивных электронных компонентов.

Нашей специализацией является поставка электронной компонентной базы двойного назначения, продукции таких производителей как XILINX, Intel (ex.ALTERA), Vicor, Microchip, Texas Instruments, Analog Devices, Mini-Circuits, Amphenol, Glenair.

Сотрудничество с глобальными дистрибьюторами электронных компонентов, предоставляет возможность заказывать и получать с международных складов практически любой перечень компонентов в оптимальные для Вас сроки.

На всех этапах разработки и производства наши партнеры могут получить квалифицированную поддержку опытных инженеров.

Система менеджмента качества компании отвечает требованиям в соответствии с ГОСТ Р ИСО 9001, ГОСТ РВ 0015-002 и ЭС РД 009

Офис по работе с юридическими лицами:

105318, г.Москва, ул.Щербаковская д.3, офис 1107, 1118, ДЦ «Щербаковский»

Телефон: +7 495 668-12-70 (многоканальный)

Факс: +7 495 668-12-70 (доб.304)

E-mail: info@moschip.ru

Skype отдела продаж:

moschip.ru

moschip.ru_4

moschip.ru_6

moschip.ru_9