

POWER

LCC600

600 Watts Conduction Cooling

Data Sheet

Total Power: 600 W
of Outputs: Single
Outputs: 12, 28, 36, 48 Vdc

SPECIAL FEATURES

- 600 W full power at elevated temperatures
- Wide operating temperature range (-40 °C to 85 °C baseplate)
- Adjustable output
- Remote output On/Off
- AC_OK; DC_OK signals
- 5 V standby voltage
- Active current share
- Conduction-cooled/fanless
- 1°C / PMBus
- Medical and ITE Safety³
- Suited for BF-type applications
- Active power factor correction
- Optional IP65 variant
- Optional 277 Vac input variant

COMPLIANCE

- EMI Class B
- EN61000 Immunity

SAFETY

- UL + CSA:** 62368-1 2nd Ed.
ANSI ES60601-1³
UL 8750⁵
CSA-C22.2 No. 250.13⁵
- TÜV:** 62368-1 2nd Ed.
60601-1 3rd Ed.³
EN 61347-1; -2-13⁵
- CB Scheme:** IEC 60950-1
IEC 60601-1
IEC 61347-1; -2-13⁵
- China** CCC
- CE Mark**



Electrical Specifications

Input													
Input range	U Suffix: 90 - 264 Vac (Safety rating: 100 - 240 Vac) 127 - 374 Vdc ⁴ H Suffix: 180 - 305 Vac (Safety rating: 200 - 277 Vac) 254 - 420 Vdc ⁴												
Frequency	47 - 63 / 440 Hz (Safety rating: 50/60 Hz)												
Input fusing	Internal fuse on both L and N lines (12.5 A - U suffix; 7 A - H suffix)												
EMI/RFI	FCC Class B, CISPR22/EN55022 Class B												
MIL-STD-461F EMI ¹	Compliance to CE101, 102; CS101, 114, 115, 116 (with external filter ¹)												
Inrush current	≤ 25 A peak												
Power factor	0.99 typical												
Harmonics	Meets EN61000-3-2 Class A and Class C ²												
Input current	< 10 Arms @ 100 Vac												
Hold up time	20 ms min for Main Output (230 Vac) @ 100% Load												
Efficiency	93.3% typical @ 230 Vac; 100% Load; 28 Vdc												
Leakage current ³	U Suffix: 115 µA typical (< 200 µA max per ANSI/ES60601-1 264 Vac split-phase / 60 Hz) 387 µA typical (< 500 µA max per IEC60601-1; 264 Vac / 50Hz) H Suffix: 0.2 mA typical (< 3.5 mA max per ITE 62368-1 Standard)												
Isolation voltage	<table border="1"> <thead> <tr> <th></th> <th>U Suffix</th> <th>H Suffix</th> </tr> </thead> <tbody> <tr> <td>PRI-SEC:</td> <td>4,000 Vac (2X MOPP)</td> <td>3,000 Vac</td> </tr> <tr> <td>PRI-Chassis:</td> <td>1,500 Vac (1X MOPP)</td> <td>2,000 Vac</td> </tr> <tr> <td>SEC-Chassis:</td> <td>1,500 Vac (1X MOPP)</td> <td>1,500 Vac</td> </tr> </tbody> </table>		U Suffix	H Suffix	PRI-SEC:	4,000 Vac (2X MOPP)	3,000 Vac	PRI-Chassis:	1,500 Vac (1X MOPP)	2,000 Vac	SEC-Chassis:	1,500 Vac (1X MOPP)	1,500 Vac
	U Suffix	H Suffix											
PRI-SEC:	4,000 Vac (2X MOPP)	3,000 Vac											
PRI-Chassis:	1,500 Vac (1X MOPP)	2,000 Vac											
SEC-Chassis:	1,500 Vac (1X MOPP)	1,500 Vac											

¹Artesyn Filter PN: 700-014447-0000 (Zhongguang PN: ZGLPG-10-02M).

²Meets Class C ≥ 50% load.

³U suffix have both ITE and Medical Safeties. H suffix carries ITE approval only.

⁴DC input rating not part of product's Safety approval.

⁵LED Lighting approvals apply to all 48 V output variants.

** LCC600 tested according to the medical standard IEC 60601-1-2 4th Edition.

Electrical Specifications

Output		
Output rating	See Ordering Information table	
Standby output	5.0 Vdc @ 1.5 A Max	
Set point	± 0.5%	Factory set point
Total regulation	Main Output: ± 2.0% 5 Vsb: ± 5%	Combined Line / Load / Temperature
Rated load	600 W maximum	600 W from -40 °C to 85 °C Baseplate Temp. Derate output to 28 W @ 95 °C Baseplate Temp
Minimum load	0 A	For both Main and 5 Vsb Outputs
Output voltage adjust range	See Ordering Information table	Max power limited to 600 W
Output noise	Main Output: 1.0% max p-p 5 Vsb: 60 mV max p-p	Measured with 0.1 µF Ceramic and 10 µF Tantalum Cap, 20 MHz BW
Remote sense	Compensation up to 500 mV	Pin 10: +Vout_RS / Pin4: -Vout_RS
Overcurrent protection	105 - 130% of full load current	Default is Shutdown mode with Auto-retry every 2-4 sec. Output latches after 20 sec of continuous OCP fault presence. Restart after latch possible through AC recycle, Inhibit toggle or through PMBus.
Overvoltage protection	125 - 145% Vo, nom Main Output 125 - 130% 5 Vsb	Latching / AC Recycle or Inhibit toggle required for PSU restart
Overtemperature protection	> 95 °C Baseplate temperature	Output Shutdown / Auto-recovery
AC_OK	Open Collector; 0.8 Vdc max / 10 mA	Active low when AC is present
DC_OK	Open Collector; 0.8 Vdc max / 10 mA	Active low when Main Output is within regulation
Remote inhibit	Contact Closure	Pin 19: Open/Float = ON; Close/Ground = OFF
# Units in parallel operation	Qualified up to 5 units in parallel. Consult factory if more than 5 are required.	Pin 5: IShare pin for main output only.
Output dimming	0-10 Vdc external voltage; 0-100 kOhm external resistance	Consult with productsupport.ep@artesy.com

Environmental Specifications

Operating temperature range	-40 °C to +85 °C Baseplate temperature
Storage temperature	-40 °C to +85 °C
Humidity	10% to 95%
Altitude	16,402 ft (Operating) / 50,000 ft (Non-Operating)
Shock	MIL-STD-810F 516.5 Procedure I, VI
Vibration	MIL-STD-810F 514.5 Cat. 4, 10
Ingress protection	IP65 (for suffix "-4P")
MTBF (calculated)	>2M Hrs, 25 °C per SR-332 Issue 3
Electromagnetic immunity	Designed to meet EN61000-4-3, -4, -5, -8, -11 (Level 3); EN61000-4-2 (Level 4); EN60601-1-2 and EN55024
	For H suffix, Level 4 for EN61000-4-5

Ordering Information

Model Number*	AC Input	Output Setpoint	Setpoint Tolerance	Output Current [A]		Max O/P Power [W]	Typical Efficiency**	Standby Output	Combined Line/Load Regulation	Output Ripple
				Min	Max					
LCC600-48U-4PD ⁽¹⁾	90 - 264	54 V	±0.5%	0	11.1	600	93.0%	5 Vdc @ 1.5 A	2%	1%
LCC600-48U-9P	90 - 264	48 V	±0.5%	0	12.5	600	93.0%	5 Vdc @ 1.5 A	2%	1%
LCC600-48H-9P	180 - 305									
LCC600-36U-9P	90 - 264	36 V	±0.5%	0	16.7	600	92.0%	5 Vdc @ 1.5 A	2%	1%
LCC600-36H-9P	180 - 305									
LCC600-28U-9P24	90 - 264	24 V	±0.5%	0	25	600	93.0%	5 Vdc @ 1.5 A	2%	1%
LCC600-28U-9P	90 - 264	28 V	±0.5%	0	25***	600	93.5%	5 Vdc @ 1.5 A	2%	1%
LCC600-28H-9P	180 - 305									
LCC600-12U-9P	90 - 264	12 V	±0.5%	0	50	600	92.3%	5 Vdc @ 1.5 A	2%	1%
LCC600-12H-9P	180 - 305									

*Change suffix "-9P" to "-4P" for IP65 rated enclosure with fly lead wires

*Change suffix "-4P" to "-4PR" for IP65 rated enclosure with right angle fly lead wires (applies to 28, 36, 48 Vdc)

*Change suffix "-4P" to "-4PV" to omit the control cable (applies to 28, 36, 48 Vdc)

*Add suffix "24" after "P" to designate output voltage factory set to 24V (only on 28V models like LCC60028H-4P24CC)

*Add suffix "CC" for Constant Current setting (e.g. "-4PCC"; "-9PCC").

**Typical efficiency at high line, factory default voltage and full load

***When Vout is adjusted down to 24 V, the supply can deliver 25 A max (600 W max). At 28 V default output setting, max lout is 21.43 A (600 W max).

⁽¹⁾ "D" suffix for 0-10 Vdc analog external volatge dimming (11.1 A CC limit). Consult Technical Reference Notes for additional details.

Mechanical Drawings

-9P Suffix

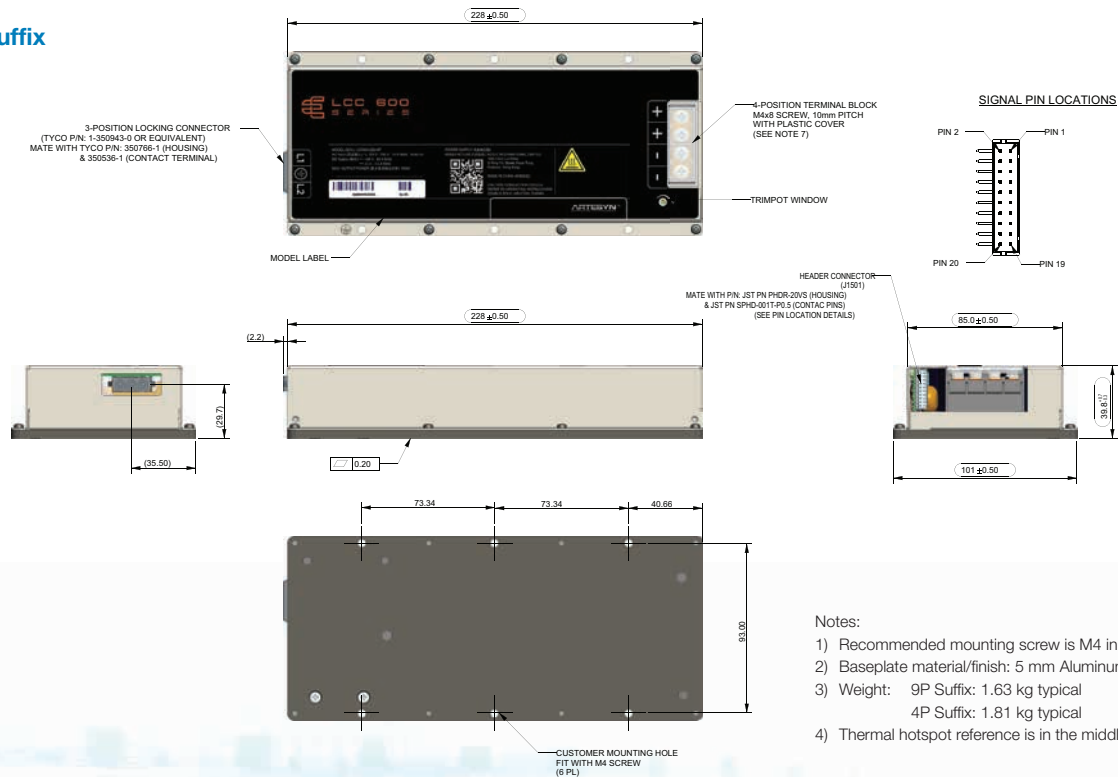

Notes:

- 1) Recommended mounting screw is M4 in 6 locations; 8-10 kgf-cm torque.
- 2) Baseplate material/finish: 5 mm Aluminum with Black Anodized.
- 3) Weight: 9P Suffix: 1.63 kg typical
4P Suffix: 1.81 kg typical
- 4) Thermal hotspot reference is in the middle of the baseplate.

Mechanical Drawings

-4P Suffix (28, 36, 48 Vdc)

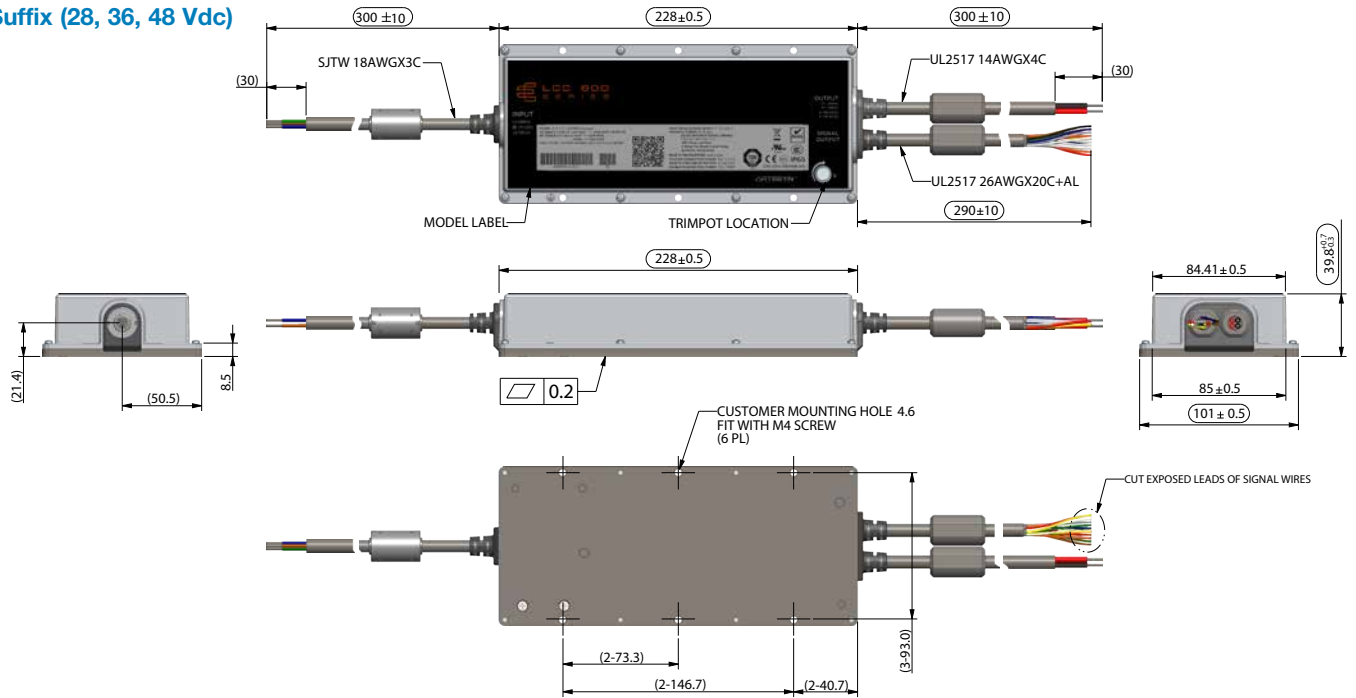

-4P Suffix (12 Vdc)

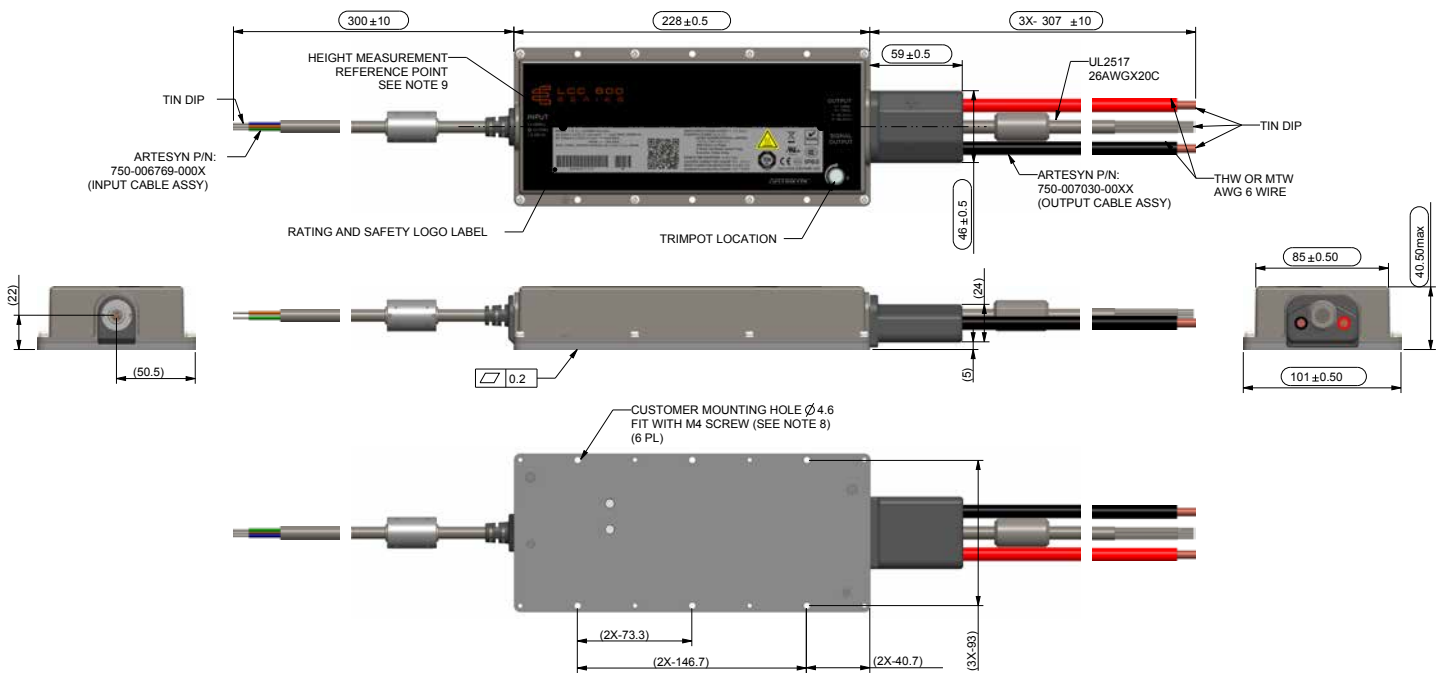

Mechanical Drawings

-4PR Suffix (28, 36, 48 Vdc)

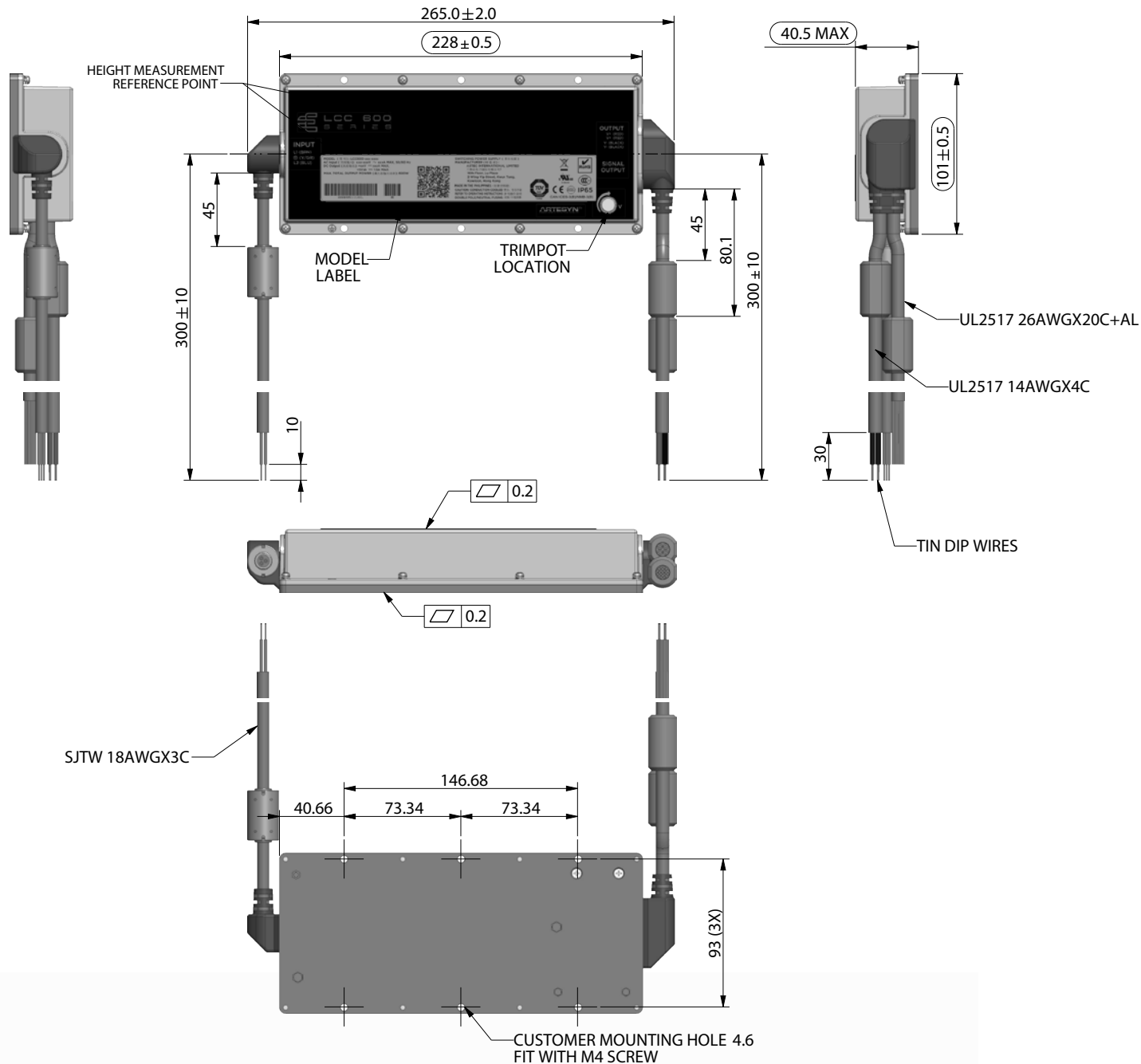

Pin Assignment (INPUT)

DESCRIPTION	-9Px Suffix		-4Px Suffix	
	DESIGNATION	NOTES	DESIGNATION	NOTES
Live	L1	Mating Connector: 350766-1 (Housing); 350536-1 (Contact Terminals)	Brown	SJTW 18AWGX3C; PVC jacket; 105 °C / 300 V
Neutral	L2		Blue	
Ground	G		Y/GR	

Pin Assignment (MAIN OUTPUT)

DESCRIPTION	-9Px Suffix		-4Px Suffix (28, 36, 48 Vdc)		-4Px Suffix (12 Vdc)	
	DESIGNATION	NOTES	DESIGNATION	NOTES	DESIGNATION	NOTES
Main Output	+Vout	4 Position Terminal Block: M4 Screw/10mm Pitch; 12kgf-cm Torque; Accepts 14-16AWG Ring Tongue - Spade Terminals MOLEX BB-124-08 (19141- 0058) or EQUIVALENT	Red	14AWGX4C; PVC jacket; 105 °C / 300 V	Red	6AWG Multi-Strand; PVC jacket; 105 °C / 600 V
Main Output Return GND	-Vout		Black		Black	
			Black			

Pin Assignment

J1501 - Signal & Control		-9Px Suffix		-4Px Suffix	
SIGNALS	DESCRIPTION	PIN #	NOTES	WIRE COLOR	NOTES
A2_OUT	EEPROM Address	1	J1501 Mating Connector: JST PN PHDR-20VS Contact Pins: JST PN SPHD- 001T-P0.5	BLACK	26AWGX20C+AL; PVC jacket; 105 °C / 300 V
GND	Ground	2		BROWN	
A1_OUT	EEPROM Address	3		RED	
-VOUT_RS	Remote Sense Return (Main O/P)	4		ORANGE	
ISHARE	Load Share Voltage	5		YELLOW	
A0_OUT	EEPROM Address	6		GREEN	
SDA	Serial Data Signal (I ² C)	7		BLUE	
SPARE_1	Spare/Unused Pin (Dimming input for "-4PD" suffix)	8		VIOLET	
SCL	Serial clock Signal (I ² C)	9		GRAY	
+VOUT_RS	Remote Sense (Main O/P)	10		WHITE	
5VSB	5V Standby (1.5A Max)	11		PINK	
SGND	5V Standby Return	12		LIGHT BLUE	
SPARE_2	Spare/Unused Pin	13		WHITE/VIOLET	
G_DCOK_C	Global DC_OK Collector	14		WHITE/YELLOW	
WP	EEPROM Write Protect	15		WHITE/ORANGE	
G_DCOK_E	Global DC_OK Emitter (GND)	16		WHITE/BLACK	
GND	Return GND for O/P Signal and I ² C communication	17		WHITE/RED	
G_ACOK_C	Global AC_OK Collector	18		WHITE/BROWN	
INH_EN	Output Inhibit_Enable Pin (turns output off)	19		WHITE/GREEN	
G_ACOK_E	Global AC_OK Emitter (GND)	20		WHITE/BLUE	

Thermal Sensing

Location	PMBus ADDR	Max Temp
Internal Secondary Output (near base plate)	8Dh	111 °C
Internal Primary Hotspot (at FET Heatsink)	8Eh	124 °C
Internal Primary Input Hotspot (near base plate)	8Fh	101 °C

Power Derating Curves

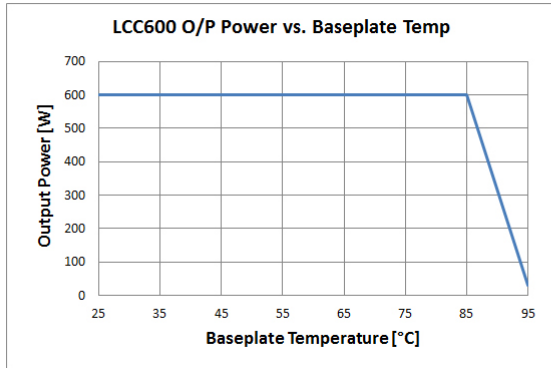

Figure 1. Output Power vs. Baseplate Temperature

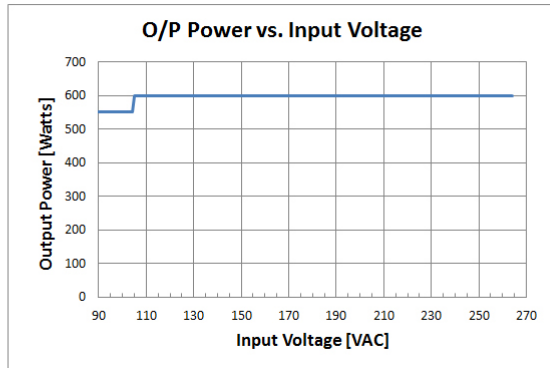

Figure 2. Output Power vs. Input Voltage

Efficiency Curves

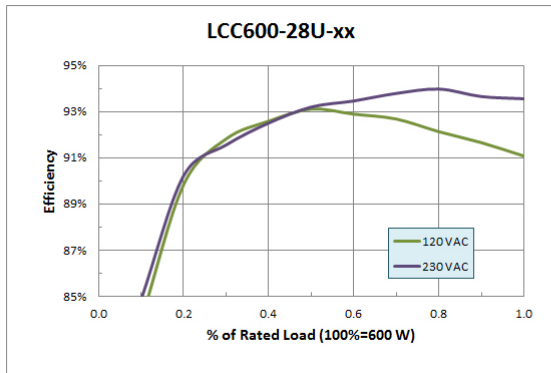

Figure 3. Typical Efficiency for 28 V output

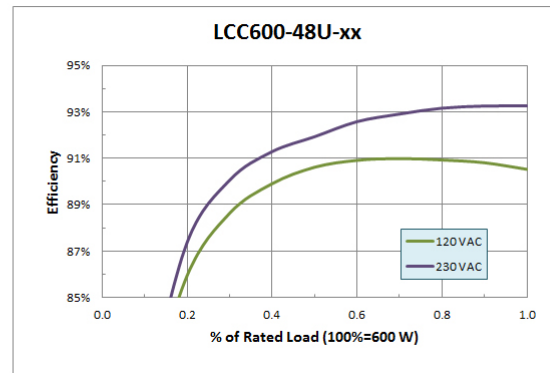

Figure 4. Typical Efficiency for 48 V output

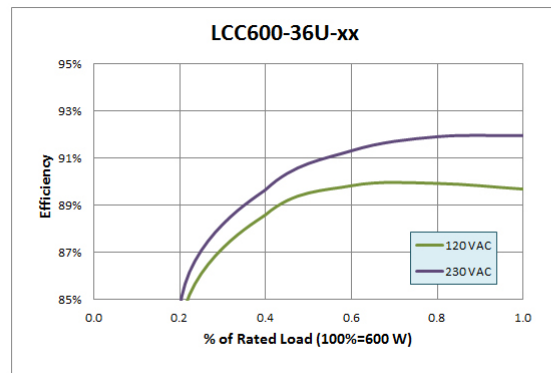

Figure 5. Typical Efficiency for 36 V output

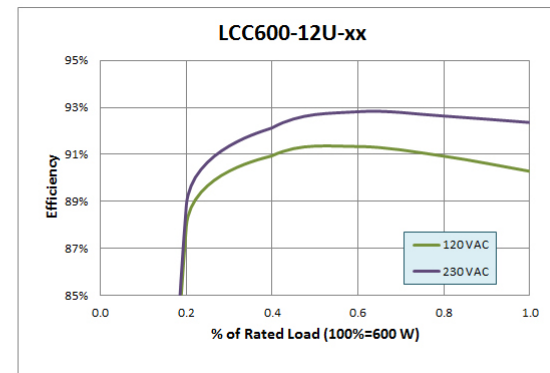
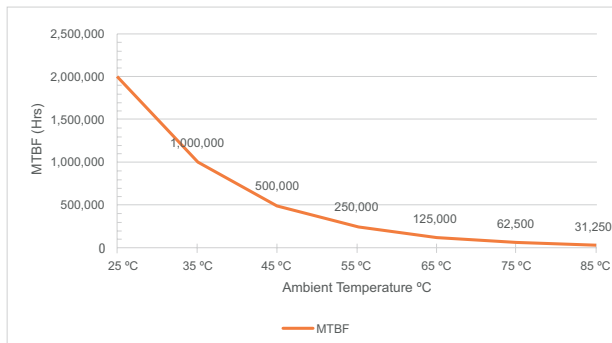

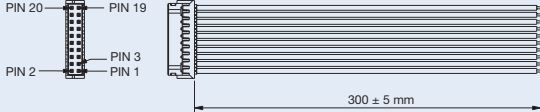
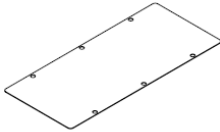

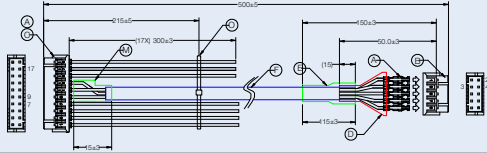
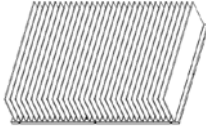

Figure 6. Typical Efficiency for 12 V output

MTBF vs. Ambient Temperature



Ambient Temperature	MTBF
25 °C	2,000,000
35 °C	1,000,000
45 °C	500,000
55 °C	250,000
65 °C	125,000
75 °C	62,500
85 °C	31,250

ACCESSORIES		
Orderable Part Number	Description	Diagram
70-841-030	For Suffix "-9P" AC Input Mating Connector Cable Assembly (w/ 0.3 m wire length)	
73-788-001	J1501 (20 Pin Control Signal) Mating Connector with 0.3 m wires attached for "-9P" suffix	
70-841-031	Pre-Cut thermal insulator (Laird TFLEX HR220FG)	
700-014447-0000	MIL-STD-461F AC input In-line EMI filter (Zhongguang ZGLPG-10-02M)	
73-769-002	USB to I²C High Speed Adaptor for PMBus Communication	
73-769-007	J1501 (20 Pin) Mating connector with 10 Pin header termination for use with 73-769-002	
466-003103-0000	Test Heatsink for unit characterization. Size: 331 x 220 x 69 mm; Aluminum with natural finish; Weight = 1.7 kgs	

WORLDWIDE OFFICES

Americas

2900 South Diablo Way
Suite B100
Tempe, AZ 85282, USA
+1 888 412 7832

Europe (UK)

Ground Floor Offices, Barbary House
4 Harbour Buildings, Waterfront West
Brierley Hill, West Midlands
DY5 1LN, UK
+44 (0) 1384 842 211

Asia (HK)

14/F, Lu Plaza
2 Wing Yip Street
Kwun Tong, Kowloon
Hong Kong
+852 2176 3333

ARTESYNTM
An Advanced Energy Company
www.artesyn.com

Artesyn Embedded Technologies, Artesyn Embedded Power, Artesyn, and all Artesyn related logos are trademarks and service marks of Artesyn Embedded Technologies, Inc. All other names and logos referred to are trade names, trademarks, or registered trademarks of their respective owners. Specifications are subject to change without notice. © 2020 Artesyn Embedded Technologies, Inc. All rights reserved. For full legal terms and conditions, please visit www.artesyn.com/legal.

For more information: www.artesyn.com
For support: productsupport.ep@artesyn.com

Данный компонент на территории Российской Федерации

Вы можете приобрести в компании MosChip.

Для оперативного оформления запроса Вам необходимо перейти по данной ссылке:

<http://moschip.ru/get-element>

Вы можете разместить у нас заказ для любого Вашего проекта, будь то серийное производство или разработка единичного прибора.

В нашем ассортименте представлены ведущие мировые производители активных и пассивных электронных компонентов.

Нашей специализацией является поставка электронной компонентной базы двойного назначения, продукции таких производителей как XILINX, Intel (ex.ALTERA), Vicor, Microchip, Texas Instruments, Analog Devices, Mini-Circuits, Amphenol, Glenair.

Сотрудничество с глобальными дистрибьюторами электронных компонентов, предоставляет возможность заказывать и получать с международных складов практически любой перечень компонентов в оптимальные для Вас сроки.

На всех этапах разработки и производства наши партнеры могут получить квалифицированную поддержку опытных инженеров.

Система менеджмента качества компании отвечает требованиям в соответствии с ГОСТ Р ИСО 9001, ГОСТ РВ 0015-002 и ЭС РД 009

Офис по работе с юридическими лицами:

105318, г.Москва, ул.Щербаковская д.3, офис 1107, 1118, ДЦ «Щербаковский»

Телефон: +7 495 668-12-70 (многоканальный)

Факс: +7 495 668-12-70 (доб.304)

E-mail: info@moschip.ru

Skype отдела продаж:

moschip.ru

moschip.ru_4

moschip.ru_6

moschip.ru_9