

# Compact and Simple Safety Control

G9SE Series Safety Relay Unit



- Slim design to save mounting space
- Simple wiring using screw-less terminals
- Easy maintenance with status indicators

# Compact and easy-to-install units with safety outputs Helps increase your productivity, from installation to maintenance

Omron's new G9SE series of safety relay units offers an easy approach for various simple safety applications. The G9SE saves mounting space, lowers installation cost with screw-less terminals, and reduces operational cost with intuitive diagnostic indicators.

## Slim design to save mounting space

The slim design of only 17.5 or 22.5 mm saves space in the control panel.

[Applicable safety standards]  
EN ISO 13849-1: PL<sub>e</sub>/Safety Category 4  
IEC 62061: SIL3  
EN81-1/-2



# G9SE Series

nance



## For various safety input devices

A wide variety of safety input devices such as emergency stop switches, door switches, and light curtains can be connected. OFF-delayed safety output models are also available.

**2 safety outputs**  
G9SE-201

**4 safety outputs**  
G9SE-401

**2 safety outputs with OFF-delay**  
G9SE-221-T05/T30



E-Stop



Door switch



Opto sensor



Safety-output contact



E-Stop



Door switch



Opto sensor



Safety-output contact



E-Stop



Door switch



Opto sensor



Safety-output contact



Safety OFF-delay contact

# Simple wiring using screw-less terminals

## Easy and reliable installation and maintenance

When the conventional model with terminals on the top and bottom of the unit is installed in a small control panel, it is difficult to secure sufficient space for wiring. The screw-less terminals on the front of the G9SE make installation easier and much quicker.

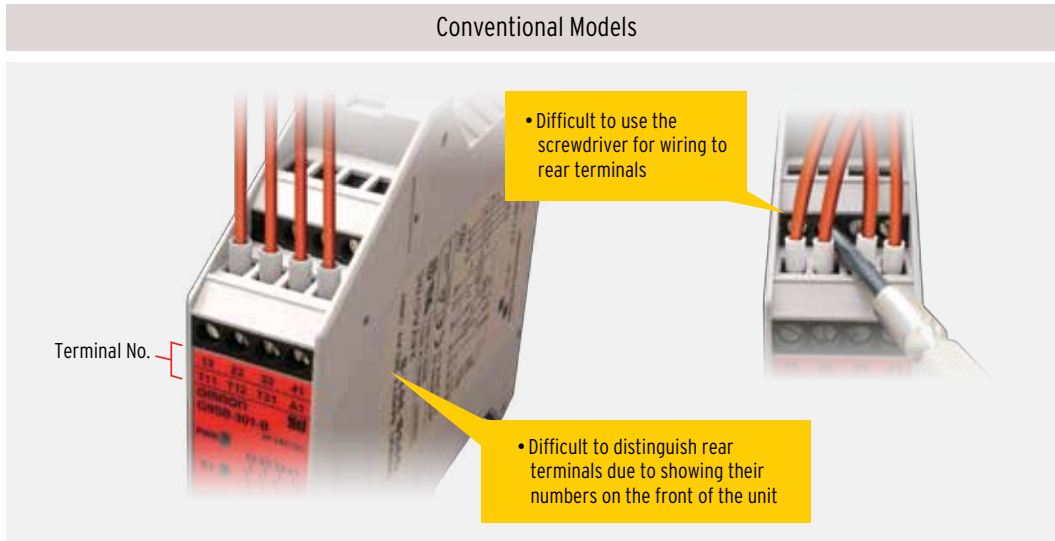



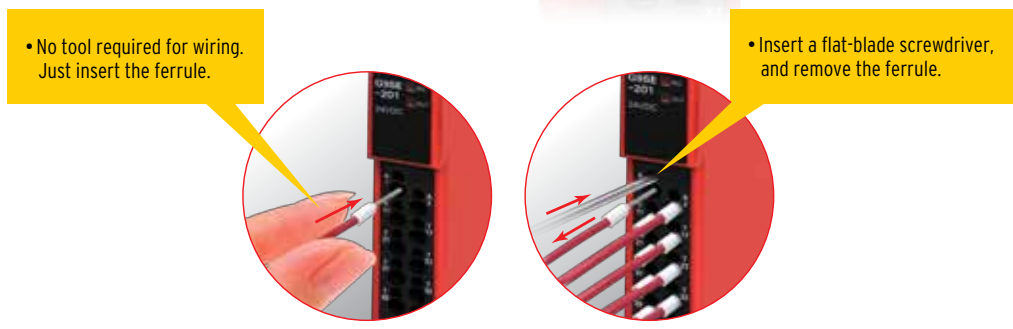
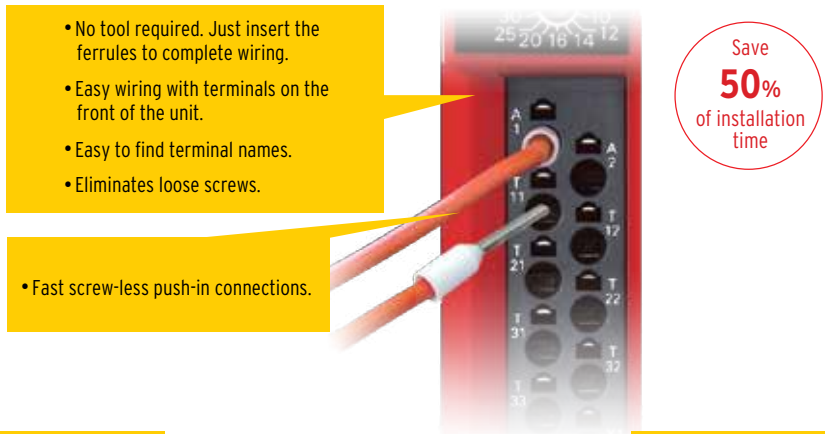



## G9SE



# Faster troubleshooting with status indicators

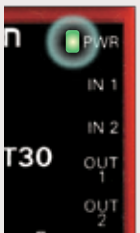

The indicators of conventional safety relay units only indicate the operating status of the internal relays (K1/K2), and it is difficult to check the operation or connection of safety input devices. The new intuitive LED indicators of the G9SE show the operating status of safety inputs and outputs, enabling faster and more accurate troubleshooting when the equipment stops.

	Safety door opened	Safety door closed	Restart switch ON
 <p><b>Conventional Models</b></p> <ul style="list-style-type: none"> <li><b>PWR</b> Power status</li> <li><b>K1</b> Internal relay 1 status</li> <li><b>K2</b> Internal relay 2 status</li> </ul>			
 <p><b>G9SE</b></p> <ul style="list-style-type: none"> <li><b>PWR</b> Power status</li> <li><b>IN1</b> Safety input 1 status</li> <li><b>IN2</b> Safety input 2 status</li> <li><b>OUT/OUT1</b> Instantaneous safety output status</li> <li><b>OUT2</b> OFF-delayed safety output status</li> </ul>			

When the G9SE detects an error, such as input wiring, an indicator will blink to show where the error has occurred. This minimizes downtime to identify the cause when the equipment stops.



Blink

Input Error	Output Error	Setting Error
 <p>Short circuit between safety inputs</p>	 <p>Fault of internal relay</p>	 <p>OFF-delay setting error</p>

# Applications

## Molding machine

---



### Safety circuit for machine

Safety relay unit  
**G9SE**



### Door position and open/close detection

Safety limit switch  
**D4B-□N**  
Small safety limit switch  
**D4N/D4F**



### Emergency stop for machine

Emergency stop switch  
**A22E**



## Machine tool

---



### Safety circuit for machine

Safety relay unit  
**G9SE**



### Door open/close detection

Guard lock safety-door switch  
**D4SL-N**



### Emergency stop for machine

Emergency stop switch  
**A22E**



## Shrink-wrap machine



### Safety circuit for machine

Safety relay unit  
**G9SE**



### Detecting entry

Safety light curtain  
**F3SJ series**



### Emergency stop for machine

Emergency stop switch  
**A22E**



## Elevator/escalator



### Safety circuit for machine

Safety relay unit  
**G9SE**



### Door position and open/close detection

Safety limit switch  
**D4B-□N**  
Small safety limit switch  
**D4N/D4F**



### Emergency stop for machine

Emergency stop switch  
**A22E**



# Safety Relay Unit

# G9SE

## Complete line-up of compact units, including OFF-delayed safety output models



- 17.5 or 22.5 mm width to save mounting space
- Simple wiring using screw-less terminals
- Easy maintenance with status indicators
- One unit for various safety devices, from contact input to PNP input



## Model Number Structure

### Model Number Legend

G9SE -     -

(1) (2) (3) (4)                      (5)

#### (1) Function

None: Emergency stop

#### (4) Auxiliary Output Configuration

1: PNP output

#### (2) Safety Output Configuration (Instantaneous Outputs)

2: DPST-NO  
4: 4PST-NO

#### (5) Max. OFF-delay Time

None:  
T05: 5 seconds  
T30: 30 seconds

#### (3) Safety Output Configuration (OFF-delayed Output)

0: None  
2: DPST-NO

## Ordering Information

Safety outputs		Auxiliary outputs *3	Max. OFF-delay time *1	Rated voltage	Model
Instantaneous	OFF-delayed *2				
DPST-NO	-	1 (Solid-state)	-	24 VDC	G9SE-201
4PST-NO					G9SE-401
DPST-NO	DPST-NO		5 s		G9SE-221-T05
DPST-NO	DPST-NO		30 s		G9SE-221-T30

\*1 The OFF-delay time can be set in 16 steps as follows:  
T05: 0/0.1/0.2/0.3/0.4/0.5/0.6/0.7/0.8/1/1.5/2/2.5/3/4/5 s  
T30: 0/1/2/4/5/6/7/8/9/10/12/14/16/20/25/30 s

\*2 The OFF-delayed output becomes an instantaneous output by setting the OFF-delay time to 0 s.

\*3 PNP transistor output



# Specifications

## Ratings

### Power Input

Item	Model	G9SE-201	G9SE-401	G9SE-221-T□
Rated supply voltage		24 VDC		
Operating voltage range		-15% to 10% of rated supply voltage		
Rated power consumption *1		3 W max.	4 W max.	

### Outputs

Item	Model	G9SE-201	G9SE-401	G9SE-221-T□
Safety output OFF-delayed Safety output		Contact output 250 VAC 5 A 30 VDC 5 A (resistive load)		
Auxiliary output		PNP transistor output Load current: 100 mA DC max.		

### Characteristics

Item	Model	G9SE-201	G9SE-401	G9SE-221-T□
Operating time (OFF to ON state) *2		100 ms Max. *3		
Response time (ON to OFF state) *4		15 ms Max.		
Accuracy of OFF-delay time		-		Within plus or minus 10% of the set value
Inputs	Input current	5 mA Min.		
	ON voltage	11 VDC Min.		
	OFF voltage	5 VDC Max.		
	OFF current	1 mA Max.		
	Maximum cable length	100 m Max.		
	Reset input time	250 ms Min.		
Contact outputs	Contact resistance *5	100 mΩ		
	Mechanical durability	5,000,000 operations Min.		
	Electrical durability	50,000 operations Min.		
	Switching specification Inductive load (IEC/EN60947-5-1)	AC15: 240 VAC 2 A DC13: 24 VDC 1.5 A		
	Minimum applicable load	24 VDC 4 mA		
Conditional short-circuit current (IEC/EN60947-5-1)		100A *6		
Pollution degree		2		
Over voltage category (IEC/EN60664-1)		Safety output: Class III, the others: Class II		
Insulation specification	Impulse withstand voltage (IEC/EN60947-5-1)	Between input and output	6 kV	
		Between different poles of output	6 kV (between 13-14/23-24 and 33-34/43-44 (37-38/47-48)) 4 kV (between 13-14 and 23-24, between 33-34 (37-38) and 43-44 (47-48))	
	Dielectric strength	Between input and output	2,200 VDC	
		Between different poles of output	1,500 VAC	
Insulation resistance		100 MΩ		
Vibration resistance *7		Frequency: 10 to 55 to 10 Hz Amplitude: 0.35 mm half amplitude (0.7 mm double amplitude)		
Mechanical shock resistance *7	Destruction	300 m/s <sup>2</sup>		
	Malfunction	100 m/s <sup>2</sup>		
Surrounding Air Temperature		-10 to 55°C (No freezing or condensation)		
Ambient humidity		25% to 85%RH		
Degree of protection		IP20		
Weight		approx. 150 g	approx. 180 g	

\*1 Power consumption of loads not included.

\*2 The operating time is the time it takes for the safety contact to close after the safety inputs and feedback-reset input are turned ON. Not includes bounce time.

\*3 This is in normal operation. When executing non-regular self-diagnosis for Safety output circuit, G9SE operating time become 500 ms max..

\*4 The response time is the time it takes for the safety main contact to open after the safety input is turned OFF. Includes bouncetime.

\*5 This is initial value using the voltage-drop method with 1A at 5VDC.

\*6 Use for each contact output an 8A fuse that conforms to IEC 60127 as a short-circuit protection device. This fuse is not included with the G9SE.

\*7 Condition: G9SE is mounted to mounting surface with screw and the screw mounting attachment. In the case of DIN rail mounting, mount DIN rail with G9SE to the place without big vibration. (Amplitude guideline: Less than 0.15 mm half amplitude (0.3 mm double amplitude))

# G9SE

## Connection

### Internal Connection

**G9SE-201**

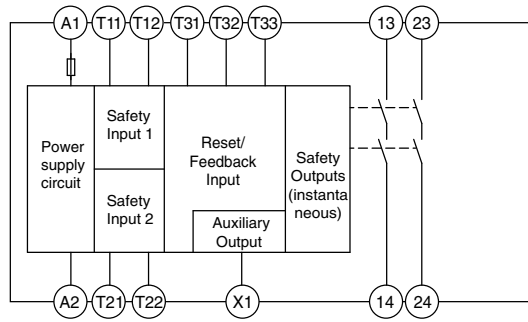

**G9SE-401**

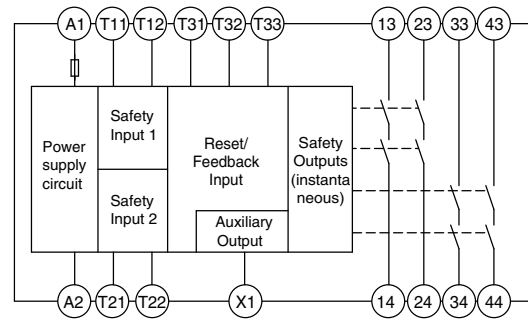

**G9SE-221-T□**

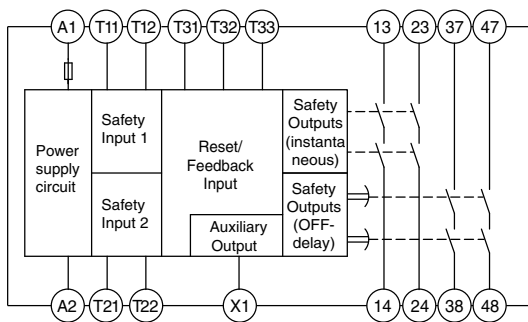

## Wiring of inputs and outputs

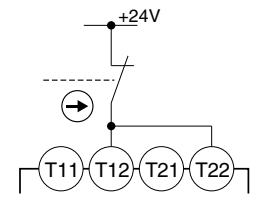
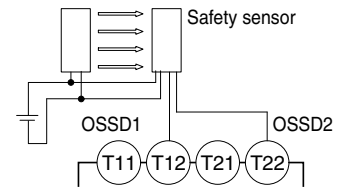
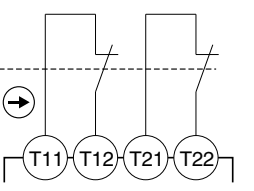
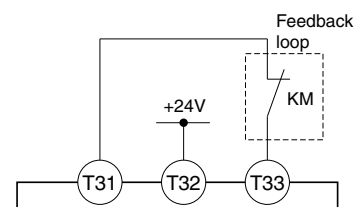
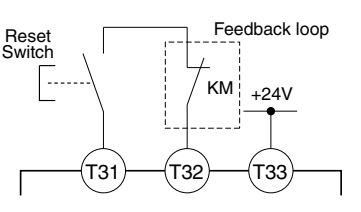
Signal Name	Terminal Name	Description of operation	Wiring
Power supply input	A1, A2	The input terminals for power supply. Connect the power source to the A1 and A2 terminals.	Connect the power supply plus to the A1 terminal. Connect the power supply minus to the A2 terminal.
Safety input 1	T11, T12	To set Safety outputs in ON state, HIGH state signals must be input to both of Safety input 1 and Safety input 2. Otherwise Safety outputs cannot be in ON state.	1-channel Safety input 
			2-channel Safety input 
Safety input 2	T21, T22		
Reset/ Feedback input	T31, T32, T33	To set Safety outputs in ON state, ON state signal must be input to T33. Otherwise Safety outputs cannot be in ON state. *1	Auto reset 
		To set Safety outputs in ON state, the signal input to T32 must change from OFF state to ON state, and then to OFF state. Otherwise Safety outputs cannot be in ON state.	Manual reset 
Safety output	13-14, 23-24, 33-34, 43-44	Turns ON/OFF according to the state of safety inputs, Feedback/Reset inputs. During off-delayed state, safety outputs are not able to turn ON.	Keep these outputs Open when NOT used.
Off-delayed Safety output	37-38, 47-48	Off-delayed safety outputs. *2 Off-delay time is set by off-delay preset switch. When the delay time is set to zero, these outputs can be used as non-delay outputs.	
Auxiliary output	X1	Outputs a signal of the same logic as Safety outputs	

\*1 Construct the safety system taking into account that in the Auto reset mode Safety outputs turn ON automatically when Safety inputs 1 and 2 turn ON.

\*2 When the inputs of G9SE-221-T□ are restored during off-delay time, G9SE-221-T□ will operate as below. Depending on the reset mode.

- Auto reset mode: Outputs turn off after off-delay time, then immediately turns on.
- Manual reset mode: Outputs turn off after off-delay time, then turn on when reset input is given.

# G9SE

## Appearance and Explanation of Each Parts

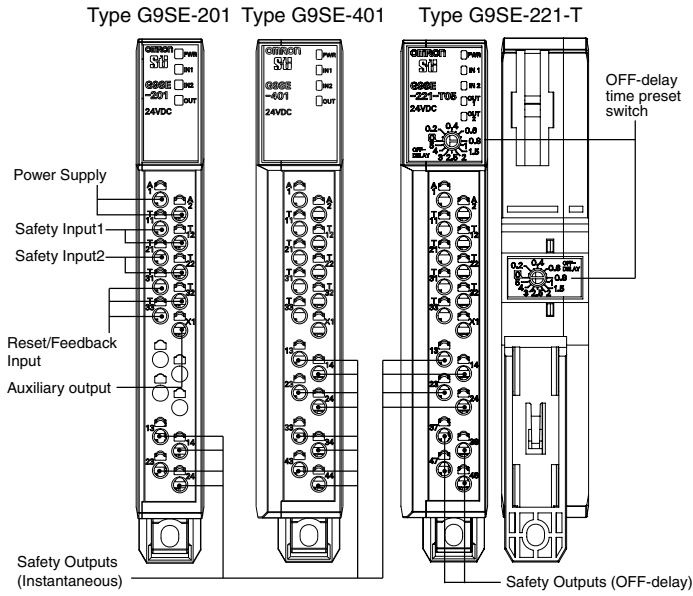

## Dimensions and Terminal arrangement

(Unit: mm)

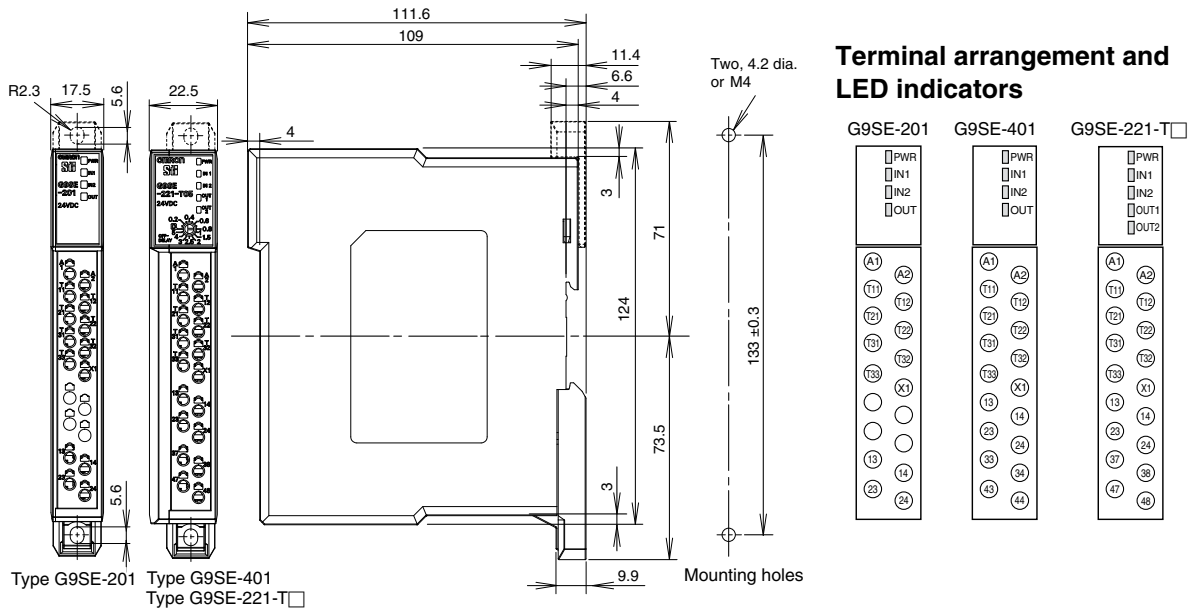

# Application Examples

## Application Overview

- Immediately removes power to Motor M when Emergency Stop Switch S1 is pressed.
- The power to Motor M is kept removed until Emergency Stop Switch S1 is released and Reset Switch S2 is pressed.

## Evaluation example

PL/safety category	Model	Stop category	Reset
PLe/4 equivalent	Emergency stop pushbutton :A22E-M-02 (2NC contact) Push Button Switch (from Annex C of ISO 13849-1) Safety Relay Unit :G9SE-201 Contactor of rated load (from Annex C of ISO 13849-1)	0	Manual

**Note:** The above PL is only the evaluation result of the example. The PL must be evaluated in an actual application by the customer after confirming the usage conditions.

## Wiring Example

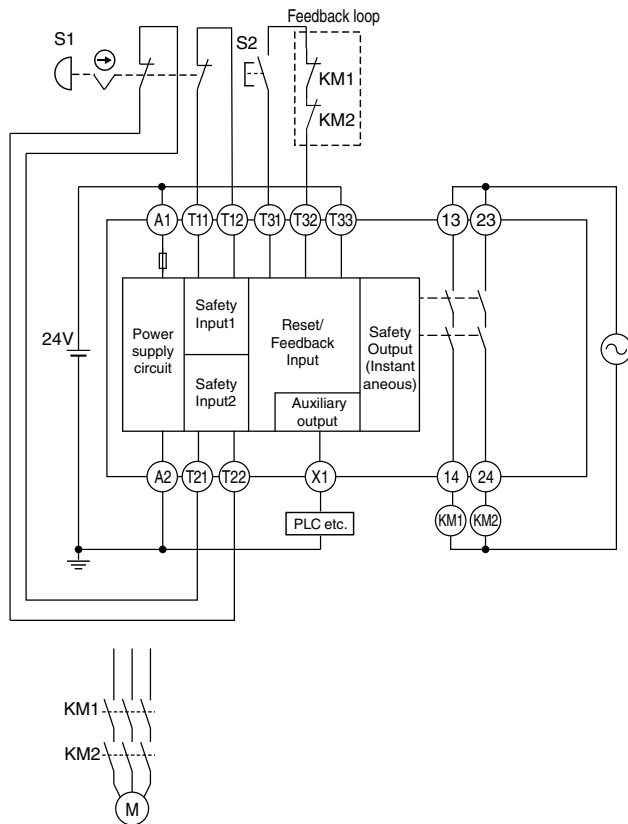

## Timing Chart

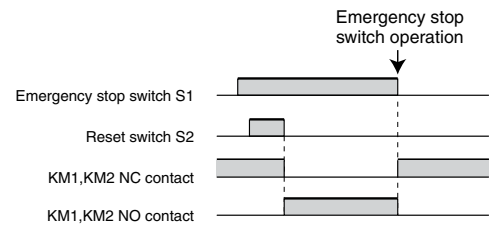

## Device

- S1: Emergency stop switch
- S2: Reset switch
- KM1, KM2: Contactor
- M: 3-phase motor

## Application Overview

- The machine has the opening of the hazardous source which is small enough to prevent a person from entering.
- The Safety Light Curtain is installed at the safe distance from the hazardous source.
- Immediately removes power to Motor M when the Safety Light Curtain detects a finger entering the area.

## Evaluation example

PL/safety category	Model	Stop category	Reset
PLe/4 equivalent	Safety Light Curtain :F3SJ-B□□□□P□□ Safety Relay Unit :G9SE-401 Contactor of rated load (from Annex C of ISO 13849-1)	0	Auto

**Note:** The above PL is only the evaluation result of the example. The PL must be evaluated in an actual application by the customer after confirming the usage conditions.

## Wiring Example

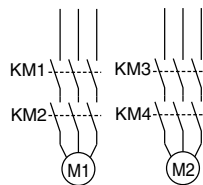
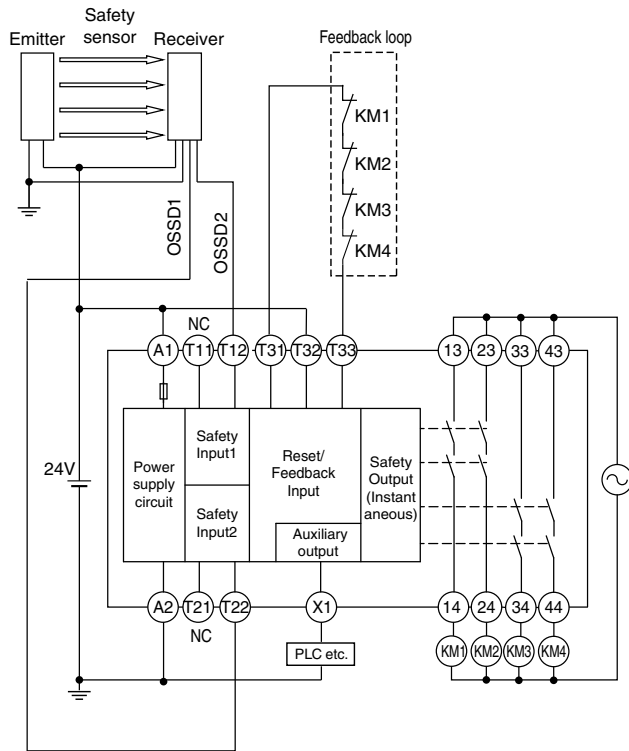

## Timing Chart

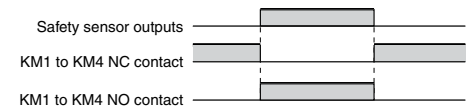

## Device

- Safety sensor
- KM1 to KM4: Contactor
- M1, M2: 3-phase motor

- Note:**
1. For further information of settings and wiring, refer to the catalog or instruction manual of the connected sensor.
  2. Use safety sensors with PNP outputs.

### Application Overview

- After OFF-delay time removes power to Motor M when Limit Switch S1 and Guard Lock Safety Door Switch S2 detect the opening of the Guard.
- When the NC contacts on both KM1 and KM2 are closed and the lock release signal is input, the Guard can be opened while Lock Release Switch S4 is pressed.
- The power to Motor M is kept removed until the Guard is closed and locked and Reset Switch S3 is pressed.

### Evaluation example

PL/safety category	Model	Stop category	Reset
PLe/4 equivalent	Safety Limit Switch :D4N-□□20 Guard Lock Safety Door Switch:D4SL-N□□□A-□(Mechanical lock) Push Button Switch(from Annex C of ISO 13849-1) Safety Relay Unit :G9SE-221-T05 Contactor of rated load (from Annex C of ISO 13849-1)	1	Manual

**Note:** The above PL is only the evaluation result of the example. The PL must be evaluated in an actual application by the customer after confirming the usage conditions.

### Wiring Example

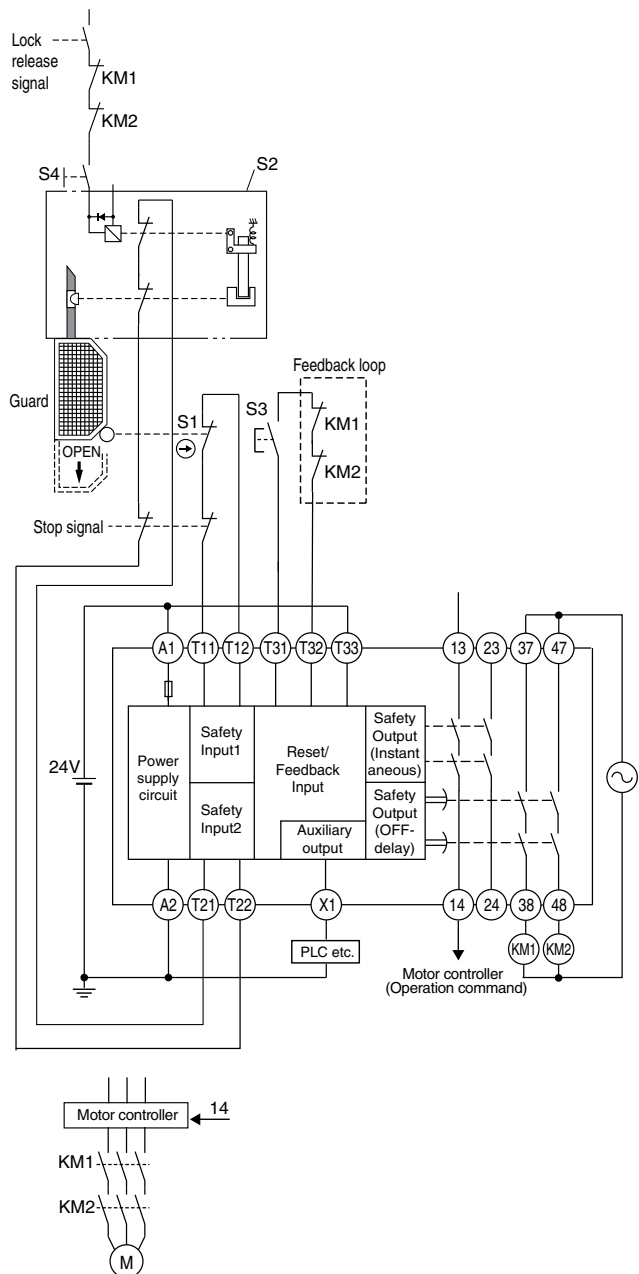

### Timing Chart

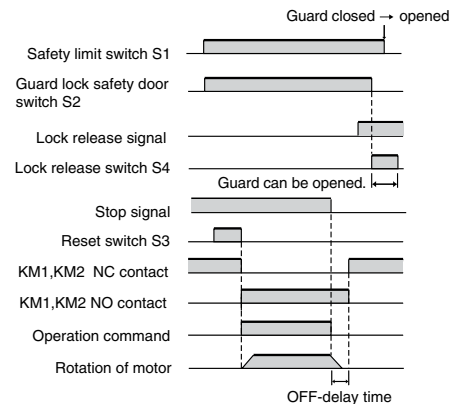



### Device

- S1: Safety limit switch
- S2: Guard lock safety door switch(Mechanical Lock)
- S3: Reset switch
- KM1, KM2: Contactor
- M: 3-phase motor





## Safety Precautions

Be sure to read the precautions for All Safety Relay in the website at:<http://www.ia.omron.com/>.

### Indication and Meaning for Safe Use

 <b>WARNING</b>	Indicates a potentially hazardous situation which, if not avoided, will result in minor or moderate injury, or may result in serious injury or death. Additionally there may be significant property damage.
	Indicates prohibited actions
	Indicates mandatory actions

### Alert Statements

 <b>WARNING</b>	
<p>Serious injury may possibly occur due to breakdown of safety outputs. Do not connect loads beyond the rated value to the safety outputs.</p>	
<p>Serious injury may possibly occur due to loss of required safety functions. Wire G9SE properly so that supply voltages or voltages for loads do NOT touch the safety inputs accidentally or unintentionally.</p>	
<p>Serious injury may possibly occur due to loss of safety functions. Use appropriate devices referring to the information shown below.</p>	

Controlling Devices	Requirements
Emergency stop switch	Use approved devices with Direct Opening Mechanism complying with IEC/EN 60947-5-1
Door interlocking switch Limit switch	Use approved devices with Direct Opening Mechanism complying with IEC/EN 60947-5-1 and capable of switching micro loads of 24VDC, 5mA.
Safety Sensor	Use approved devices complying with the relevant product standards, regulations and rules in the country where it is used.
Relay with forcibly guided contacts	Use approved devices with forcibly guided contacts complying with EN 50205. For feedback purpose use devices with contacts capable of switching micro loads of 24VDC, 5mA.
Contactors	Use contactors with forcibly guided mechanism to input the signal to Feedback/Reset input of G9SE through the NC contact of the contactor. For feedback purpose use devices with contacts capable of switching micro loads of 24VDC, 5mA. Failure to open contacts of a contactor cannot be detected by monitoring its auxiliary NC contact without forcibly guided mechanism.
Other devices	Evaluate whether devices used are appropriate to satisfy the requirements of safety category level.

### Precautions for Safe Use

- (1) Use G9SE within an enclosure with IP54 protection or higher of IEC/EN60529.
- (2) When ready for wiring, the power source shall be disconnected the terminals in order to prevent an electrical shock.
- (3) Do not apply any excessive voltage or current to the input or output circuit the G9SE. Doing so may result in damage to the G9SE or cause a fire.
- (4) Incorrect wiring may lead to loss of safety function. Wire conductors correctly and verify the operation of G9SE before commissioning the system in which G9SE is incorporated.
- (5) Do not apply DC voltages exceeding the rated voltages, or AC voltages to G9SE.
- (6) Use SELV/PELV DC supply satisfying requirements below to prevent electric shock.
  - DC power supply with double or reinforced insulation, for example, according to IEC/EN60950 or EN50178 or a transformer according to IEC/EN61558.
  - DC supply satisfies the requirement for class 2 circuits stated in UL 508.
- (7) The lifetime of G9SE depends on the conditions of switching of its outputs. Be sure to conduct its test operation under actual operating conditions in advance and use it within appropriate switching cycles. Apply protection circuitry against back electromotive force in case connecting inductive loads to safety outputs.
- (8) Do not operate the G9SE with flammable or explosive gas. An arc with operation and the heat of relay will cause a fire or an explosion.
- (9) Do not drop G9SE to the ground or dismantle, repair, modify G9SE, otherwise an electric shock may occur or the G9SE may malfunction. It may lead to loss of its safety functions.
- (10) Use protective device (Fuse etc.) for short-circuit protection and ground fault protection, otherwise a fire may occur or the G9SE may malfunction.
- (11) Auxiliary monitoring outputs are NOT safety outputs. Do not use auxiliary outputs as any safety output.  
Such incorrect use causes loss of safety function of G9SE and its relevant system.
- (12) After installation of G9SE, qualified personnel shall confirm operations and maintenance.  
The qualified personnel shall be qualified and authorized to secure the safety on each phases of design, installation, running, maintenance and disposal of system.
- (13) A person in charge, who is familiar to the machine in which G9SE is to be installed, shall conduct and verify the installation.
- (14) Perform daily and 6-month inspections for the G9SE. Otherwise, the system may fail to work properly, resulting in serious injury.  
Turn OFF the signal to Safety input and make sure G9SE operates without fault by checking the state of the LED indicator in inspection.
- (15) Conformity to requirements of performance level is determined as an entire system. It is recommended to consult a certification body regarding assessment of conformity to the required safety level.
- (16) OMRON shall not be responsible for conformity with any safety standards regarding to customer's entire system.
- (17) Dispose of the Units according to local ordinances as they apply.



### Precautions for Correct Use

- (1) Handle with care  
Do not drop G9SE to the ground or expose to excessive vibration or mechanical shocks. G9SE may be damaged and may not function properly.
- (2) Adhesion of solvent such as alcohol, thinner, trichloroethane or gasoline on the product should be avoided. Such solvents make the marking on G9SE illegible and cause deterioration of parts.
- (3) Conditions of storage  
Do not store in such conditions stated below.
  1. In direct sunlight
  2. At ambient temperatures out of the range of -10 to 55 °C
  3. At relative humidity out of the range of 25% to 85% or under such temperature change that causes condensation.
  4. At atmospheric pressure out of the range 86 to 106 kPa.
  5. In corrosive or combustible gases
  6. With vibration or mechanical shocks out of the rated values.
  7. Under splashing of water, oil, chemicals
  8. In the atmosphere containing dust, saline or metal powder and other conductive dusts.  
G9SE may be damaged and may not function properly.
- (4) At least 50 mm above top face of G9SE and below bottom face of G9SE should be available to apply rated current to outputs of G9SE and for enough ventilation.
- (5) Mounting multiple units  
When mounting multiple units close to each other, the rated current will be 3 A. Do not apply a current higher than 3 A. If the output current is 3 A or more, make sure that there is a minimum distance of 10mm each between all adjacent G9SE units.
- (6) DIN rail mounting  
Mount G9SE to DIN rails with attachments (TYPE PFP-M, not incorporated to this product), not to drop out of rails by vibration etc. especially when the length of DIN railing is short compared to the widths of G9SE.
- (7) Wire correctly according to Wiring.
- (8) Use cables with length less than 100 m to connect to Safety Inputs, Feed-back/Reset inputs, respectively.
- (9) G9SE may malfunction due to electro-magnetic disturbances. Be sure to connect the negative terminal of DC power supply to ground. When using a DC power supply with light curtains, use DC power supply which has no interruption by a power failure of 20 ms.
- (10) This is a class A product. In residential areas it may cause radio interference, in which case the user may be required to take adequate measures to reduce interference.
- (11) Do NOT mix AC load and DC load to be switched in the following terminals.
  - G9SE-201 : between 13-14 terminal and 23-24 terminal
  - G9SE-401 : between 13-14 terminal and 23-24 terminal, 33-34 terminal and 43-44 terminal
  - G9SE-221-T□ : between 13-14 terminal and 23-24 terminal, 37-38 terminal and 47-48 terminal
- (12) Start entire system after more than 2s have passed since applying supply voltage to G9SE.
- (13) Set the time duration of OFF-delay (Type G9SE-221-T□)
  1. Set the time duration of OFF-delay to an appropriate value that does not cause the loss of safety function of system.
  2. Set both of the two O on the front and back, to the same value.  
When setting the de After setting, make sure G9SE operating time is correct.
- (14) To determine safety distance to hazards, take into account the delay of Safety outputs caused by the following time:
  1. Response time
  2. Preset off-delay time and accuracy of off-delay time
- (15) Before G9SE outputs become in ON-state, non-regular self-diagnosis for Safety output circuit may be executed. On this occasion, the operating noise of internal relays occurs.
- (16) In the place subjected to strong vibration or shock, mount G9SE to a mounting surface with screws and the screw mounting attachment.  
Otherwise, G9SE may not function properly due to vibration or mechanical shocks out of the rated values caused by sympathetic vibration of G9SE and the mounting parts, and so on.

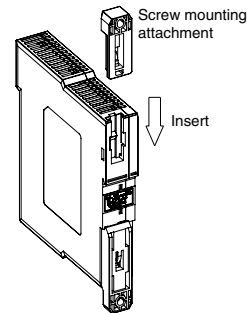

## Wiring

Use the following to wire to G9SE.

- Solid wire: AWG24 to AWG16 (0.25 to 1.5 mm<sup>2</sup>)
- Stranded wire: AWG24 to AWG16 (0.25 to 1.5 mm<sup>2</sup>)
- Strip the cover of wire no longer than 8 to 10 mm

When using stranded wire, insulated ferrule should be used. Use below insulated ferrule.

But do not use ferrule terminals if G9SE is used as UL Listing. Insert the strand or solid wire (CU only) directly into the holes on the terminal block.

- Insulated ferrule: AWG24 to AWG16 (0.25 to 1.5 mm<sup>2</sup>)
- Crimp height(H): 2.0 mm max
- Width(W): 2.7 mm max.
- Conductor length: 8 to 10 mm

■ Recommended insulated ferrule:  
manufactured by Phoenix contact

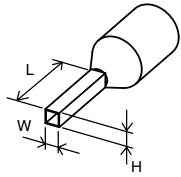

Type	Wire size		
	Cross section (mm <sup>2</sup> )	AWG	
Single	Al 0,34-8TQ	0,34	22
	Al 0,5-10WH	0,5	20
	Al 0,75-10GY	0,75	18
	Al 1-10RD	1,0	18
	Al 1.5-10BK	1,5	16
Twin	Al TWIN2x0.75-10GY	2 x 0.75	—

### How to insert solid wire and insulated ferrule

The wire should be pushed into the terminal block straight. No need to use the driver.

After inserting, make sure wire is fastened on to terminal block.

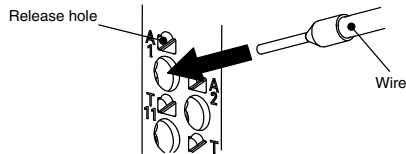

### How to release wire

Use the following minus drive to release wire from terminal block.

And When releasing wire, the power source should be disconnected

1. Push the driver lightly into the taper of release hole.
2. Pull out the wire while the driver is pushed into release hole.
3. Pull out the driver.

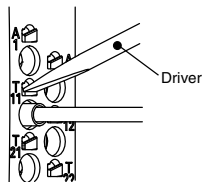

Recommended driver:  
Type SZF0-0.4mmx2.5mm  
manufactured by Phoenix contact  
Type XW4Z-00B manufactured by Omron

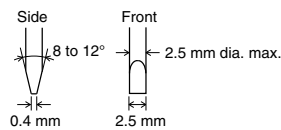

### Precautions for Correct wiring

Terminal block may be damaged.

1. Not push the driver into the release hole straight.
2. Not push the driver into the release hole by force of 30N and over.
3. Not tip or twist the driver pushed into release hole.

## Standards

### Certified Standards

EN ISO13849-1: 2008 PL e Safety Category 4,  
IEC/EN 60947-5-1, IEC/EN 62061 SIL3,  
EN 81-1, EN81-2,  
UL508, CAN/CSA C22.2 No.14  
GB 14048.5

### Safety category

In the conditions shown in '5.Examples of Application', G9SE can be used for the corresponding safety categories up to 4 and performance level(PL) up to e per ISO13849-1.

This does NOT mean that G9SE can always be used for the required category under all the similar conditions and situations.

Conformity to the categories must be assessed as a whole system. When using G9SE for the safety categories, make sure the conformity of the whole system.

### Performance level and safety category (EN ISO13849-1)

- (1) Input the signals to both of the Safety inputs (T12 and T22)
- (2) Input a signal to the Safety inputs (T11-T12 and T21-T22) through switches with Direct Opening Mechanism. When using limit switches, at least one of them must have Direct Opening Mechanism.  
And wiring must be done in a way that a short circuit between the wires of Safety input can be prevented.
- (3) When connecting Safety sensor with G9SE, use TYPE 4 safety sensor.
- (4) Be sure to connect the negative terminal of DC power supply to ground.
- (5) Use two Safety outputs (e.g. 13-14 and 23-24) to construct the system.
- (6) In order to ensure sufficient failure detection, it is mandatory to use G9SE only together with contactors or relays with forcibly guided contacts.
- (7) Input the signal through NC contacts of the contactors to Feedback/Reset input (T31-T32 for manual reset or T31-T32 for auto reset). (Refer to 'Application Examples')

Model	Condition / Function	SIL	PFHd	PL	Category	MTTFd	DCavg
G9SE-201	Instantaneous Safety Output	3	2.8E-08	e	4	100	98
G9SE-401	Instantaneous Safety Output	3	5.1E-08	e	4	53	99
G9SE-221-T	Instantaneous Safety Output, Release Delayed Safety Output	3	5.1E-08	e	4	53	99



**OMRON AUTOMATION AMERICAS HEADQUARTERS** • Chicago, IL USA • 847.843.7900 • 800.556.6766 • [www.omron247.com](http://www.omron247.com)

**OMRON CANADA, INC. • HEAD OFFICE**

Toronto, ON, Canada • 416.286.6465 • 866.986.6766 • [www.omron247.com](http://www.omron247.com)

**OMRON ELECTRONICS DE MEXICO • HEAD OFFICE**

México DF • 52.55.59.01.43.00 • 01-800-226-6766 • [mela@omron.com](mailto:mela@omron.com)

**OMRON ELECTRONICS DE MEXICO • SALES OFFICE**

Apodaca, N.L. • 52.81.11.56.99.20 • 01-800-226-6766 • [mela@omron.com](mailto:mela@omron.com)

**OMRON ELETRÔNICA DO BRASIL LTDA • HEAD OFFICE**

São Paulo, SP, Brasil • 55.11.2101.6300 • [www.omron.com.br](http://www.omron.com.br)

**OMRON ARGENTINA • SALES OFFICE**

Cono Sur • 54.11.4783.5300

**OMRON CHILE • SALES OFFICE**

Santiago • 56.9.9917.3920

**OTHER OMRON LATIN AMERICA SALES**

54.11.4783.5300

**OMRON EUROPE B.V.** • Wegalaan 67-69, NL-2132 JD, Hoofddorp, The Netherlands. • +31 (0) 23 568 13 00 • [www.industrial.omron.eu](http://www.industrial.omron.eu)

*Authorized Distributor:*

**Automation Control Systems**

- Machine Automation Controllers (MAC) • Programmable Controllers (PLC)
- Operator interfaces (HMI) • Distributed I/O • Software

**Drives & Motion Controls**

- Servo & AC Drives • Motion Controllers & Encoders

**Temperature & Process Controllers**

- Single and Multi-loop Controllers

**Sensors & Vision**

- Proximity Sensors • Photoelectric Sensors • Fiber-Optic Sensors
- Amplified Photomicrosensors • Measurement Sensors
- Ultrasonic Sensors • Vision Sensors

**Industrial Components**

- RFID/Code Readers • Relays • Pushbuttons & Indicators
- Limit and Basic Switches • Timers • Counters • Metering Devices
- Power Supplies

**Safety**

- Laser Scanners • Safety Mats • Edges and Bumpers • Programmable Safety Controllers • Light Curtains • Safety Relays • Safety Interlock Switches

## Данный компонент на территории Российской Федерации

### Вы можете приобрести в компании MosChip.

Для оперативного оформления запроса Вам необходимо перейти по данной ссылке:

<http://moschip.ru/get-element>

Вы можете разместить у нас заказ для любого Вашего проекта, будь то серийное производство или разработка единичного прибора.

В нашем ассортименте представлены ведущие мировые производители активных и пассивных электронных компонентов.

Нашей специализацией является поставка электронной компонентной базы двойного назначения, продукции таких производителей как XILINX, Intel (ex.ALTERA), Vicor, Microchip, Texas Instruments, Analog Devices, Mini-Circuits, Amphenol, Glenair.

Сотрудничество с глобальными дистрибьюторами электронных компонентов, предоставляет возможность заказывать и получать с международных складов практически любой перечень компонентов в оптимальные для Вас сроки.

На всех этапах разработки и производства наши партнеры могут получить квалифицированную поддержку опытных инженеров.

Система менеджмента качества компании отвечает требованиям в соответствии с ГОСТ Р ИСО 9001, ГОСТ РВ 0015-002 и ЭС РД 009

### Офис по работе с юридическими лицами:

105318, г.Москва, ул.Щербаковская д.3, офис 1107, 1118, ДЦ «Щербаковский»

Телефон: +7 495 668-12-70 (многоканальный)

Факс: +7 495 668-12-70 (доб.304)

E-mail: [info@moschip.ru](mailto:info@moschip.ru)

Skype отдела продаж:

moschip.ru

moschip.ru\_4

moschip.ru\_6

moschip.ru\_9