

DPDT SWITCH GaAs MMIC

■ GENERAL DESCRIPTION

The NJG1617K11 is a DPDT switch MMIC which features low insertion loss, high isolation, wide frequency range (0.1-over 6GHz) and low operating voltage from 2.7V.

Thin switch is suited for wireless LAN IEEE 802.11b/802.11g (2.4GHz band) and IEEE 802.11a (5GHz band).

The industrial standard QFN12-11 package is applied.

■ PACKAGE OUTLINE

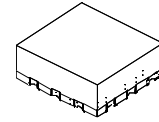

NJG1617K11

■ FEATURES

- Low voltage operation +2.7~+5.0V
- Pin at 0.2dB compression point +32dBm typ. @f=6.0GHz, $V_{CTL}=+3.0V$
- Low insertion loss 0.7dB typ. @f=2.5GHz
- High isolation 0.75dB typ. @f=6.0GHz
- Ultra small & ultra thin package 30dB typ. @f=2.5GHz
- Ultra small & ultra thin package 25dB typ. @f=6.0GHz
- Ultra small & ultra thin package QFN12-11 (Package size: 3.0x3.0x0.75mm)

■ PIN CONFIGURATION

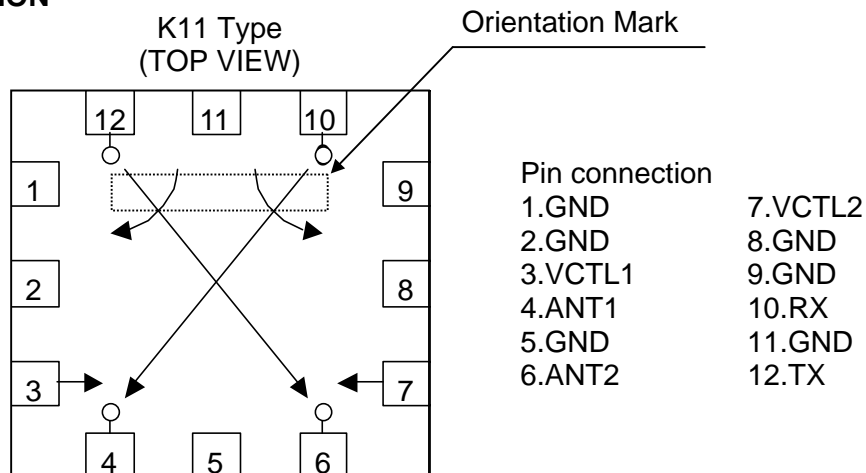

■ TRUTH TABLE

Control Voltage: "H" $=V_{CTL(H)}$, "L" $=V_{CTL(L)}$

PASS	CONTROL SIGNAL	
	VCTL1	VCTL2
ANT1-TX ANT2-RX	L	H
ANT1-RX ANT2-TX	H	L

NOTE: Please note that any data or drawing in this catalog is subject to change.

NJG1617K11

■ ABSOLUTE MAXIMUM RATINGS

(T_a=+25°C)

PARAMETER	SYMBOL	CONDITIONS	RATINGS	UNITS
RF Input Power	P _{IN}	V _{CTL} =0V/+3.0V	+33	dBm
Control Voltage	V _{CTL}	V _{CTL} terminal	+7.5	V
Operating Temp.	T _{opr}		-40~+85	°C
Storage Temp.	T _{stg}		-55~+150	°C

■ ELECTRICAL CHARACTERISTICS

(General conditions: T_a=+25°C, Z_s=Z_l=50Ω, V_{CTL(L)}=0V, V_{CTL(H)}=+3.0V)

PARAMETERS	SYMBOL	CONDITIONS	MIN	TYP	MAX	UNITS
Control Voltage (LOW)	V _{CTL(L)}		-0.2	-	0.2	V
Control Voltage (HIGH)	V _{CTL(H)}		2.7	3.0	5.0	V
Control Current	I _{CTL}	f=5.25GHz	-	0.5	5.0	μA
Insertion Loss 1	LOSS1	f=2.5GHz, Pin=20dBm	-	0.7	0.9	dB
Insertion Loss 2	LOSS2	f=6.0GHz, Pin=20dBm	-	0.75	1.0	dB
Isolation 1	ISL1	f=2.5GHz, Pin=20dBm TX,RX-ANT1,ANT2	25	30	-	dB
Isolation 2	ISL2	f=6.0GHz, Pin=20dBm TX,RX-ANT1,ANT2	20	25	-	dB
Pin at 0.2dB Compression Point	P _{-0.2dB}	f=5.25GHz	29	32	-	dBm
VSWR	VSWR	f=0.1~6.0GHz	-	1.2	1.5	
Switching Time	T _{SW}	f=0.1~6.0GHz	-	20	100	ns

■ TERMINAL INFORMATION

No.	SYMBOL	DESCRIPTION
3	VCTL1	Control signal input terminal. This terminal is set to High-Level (+2.7~+5.0V) or Low-Level (-0.2~+0.2V).
4	ANT1	Antenna port. An external capacitor is required to block DC voltage.
6	ANT2	Antenna port. An external capacitor is required to block DC voltage.
7	VCTL2	Control signal input terminal. This terminal is set to High-Level (+2.7~+5.0V) or Low-Level (-0.2~+0.2V).
10	RX	RF receiving port. An external capacitor is required to block DC voltage.
12	TX	RF transmitting port. An external capacitor is required to block DC voltage.
1,2,5,8, 9,11	GND	Ground terminal. Please connect this terminal with ground plane as close as possible for excellent RF performance.

NJG1617K11

■ ELECTRICAL CHARACTERISTICS

(With application circuit, Losses of Blocking Capacitor, and external circuit are excluded)

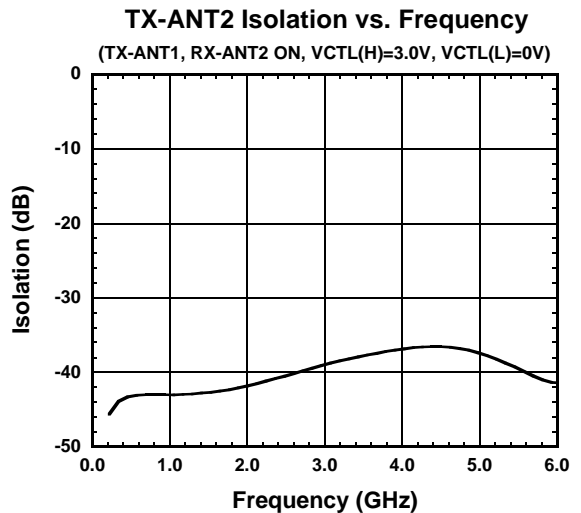
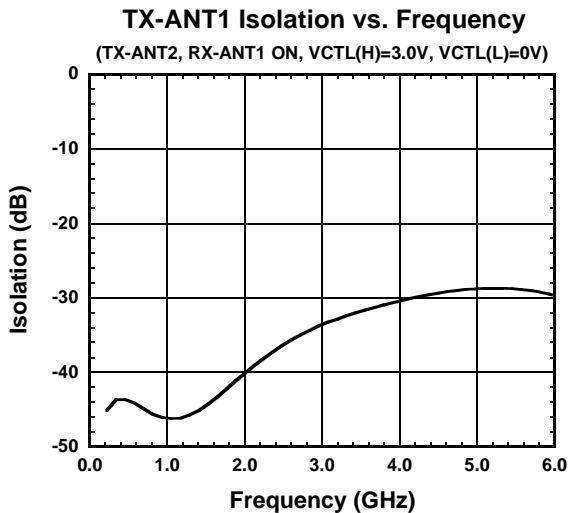
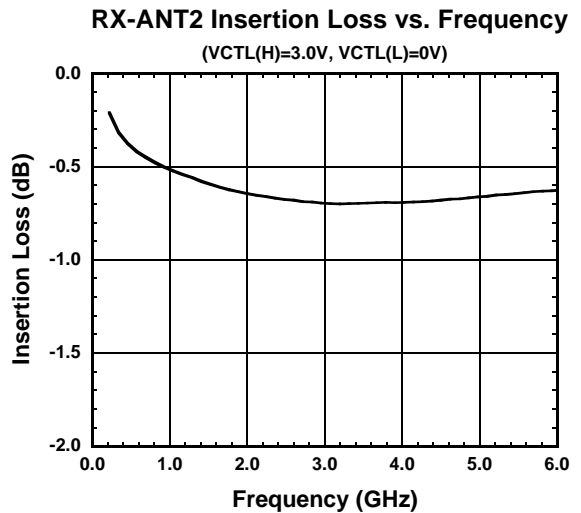
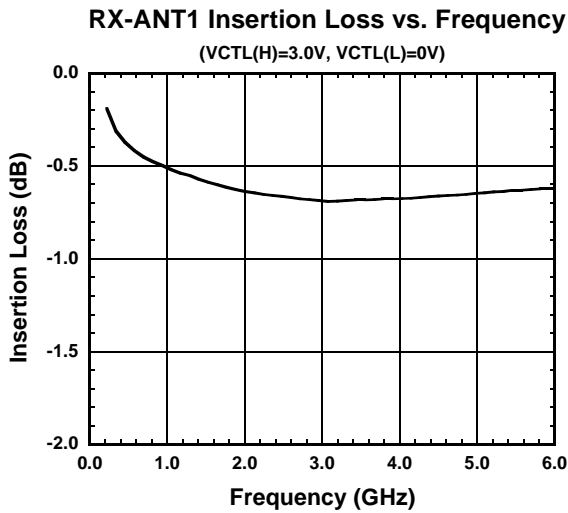
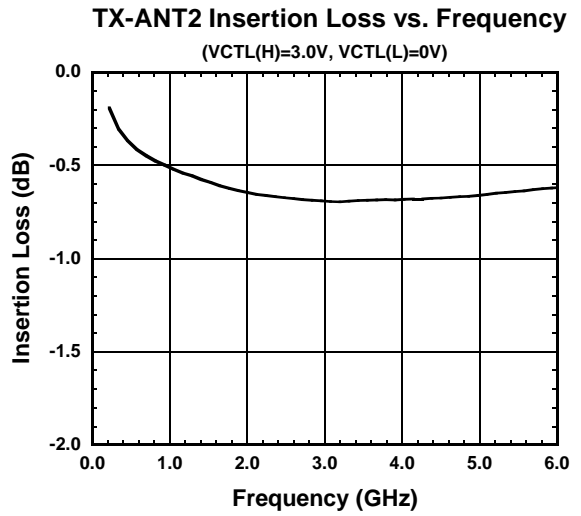
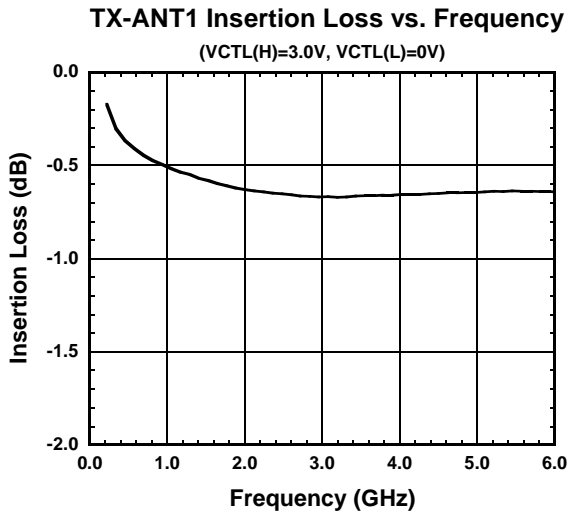

■ ELECTRICAL CHARACTERISTICS

(With application circuit, Losses of Blocking Capacitor, and external circuit are excluded)

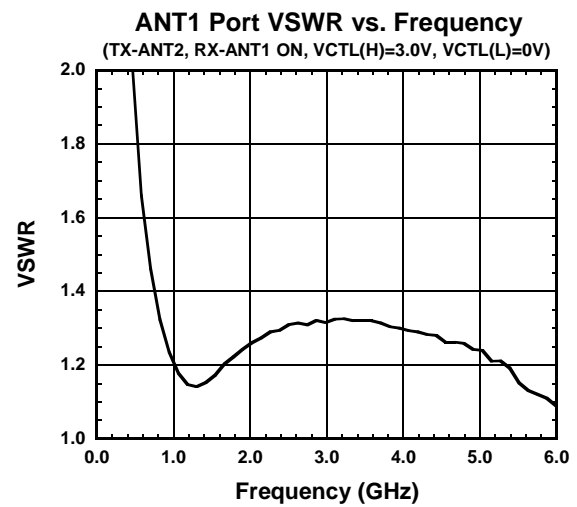
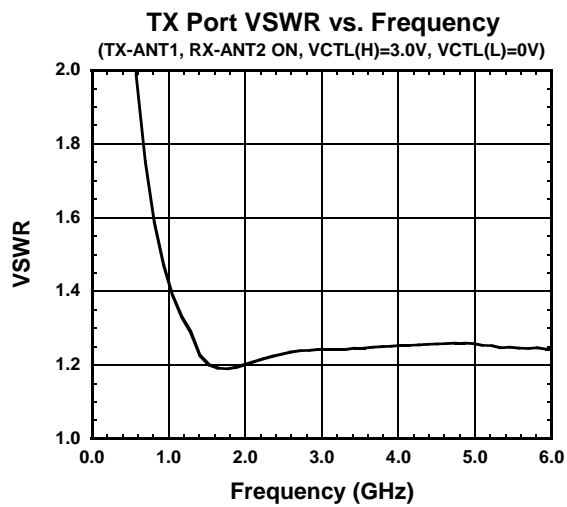
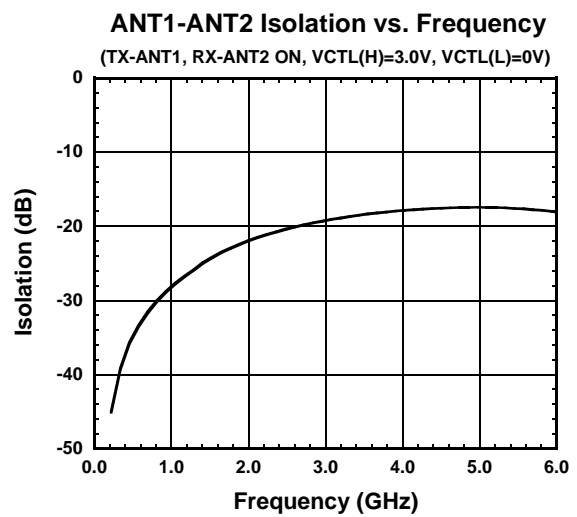
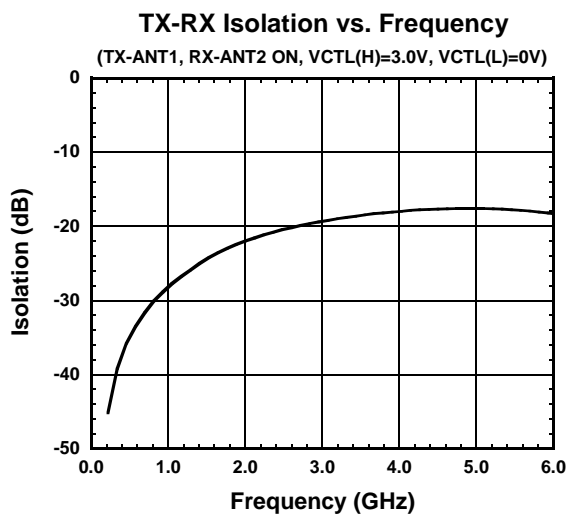
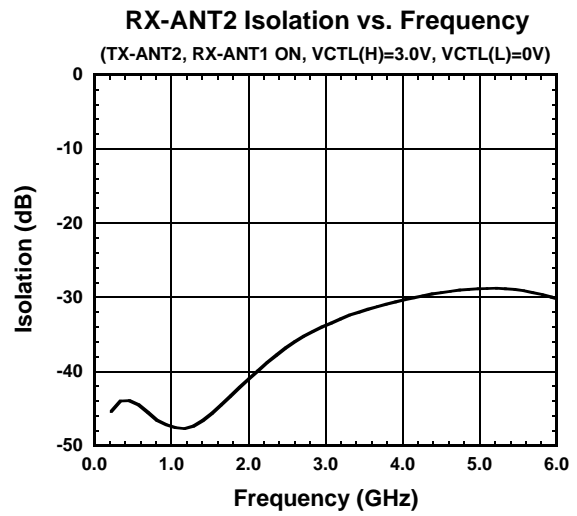
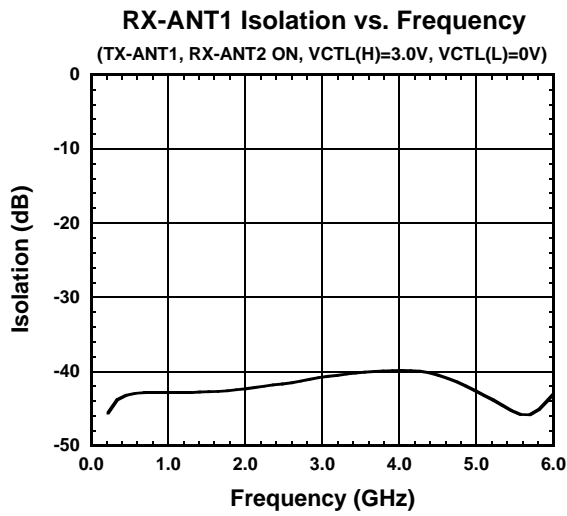

NJG1617K11

■ ELECTRICAL CHARACTERISTICS

(With application circuit, Losses of Blocking Capacitor, and external circuit are excluded)

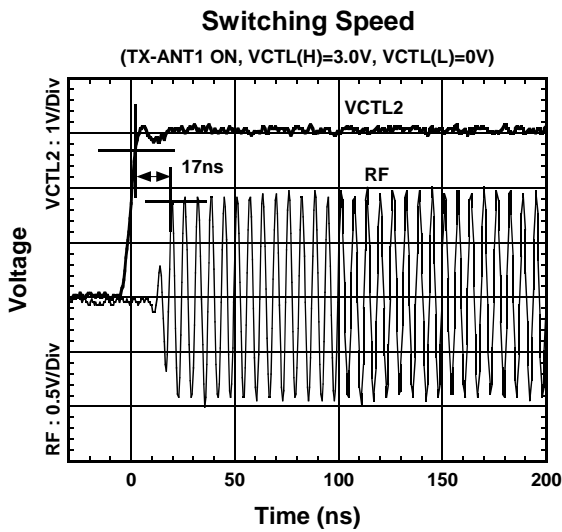
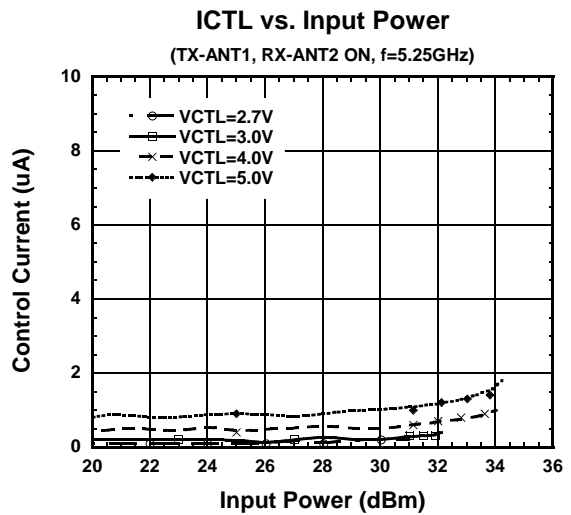
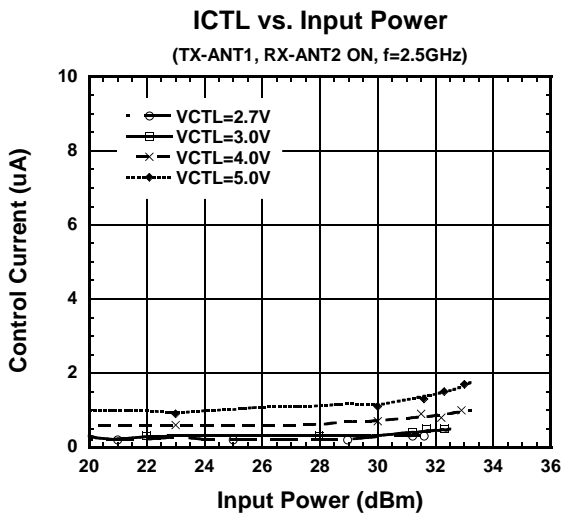
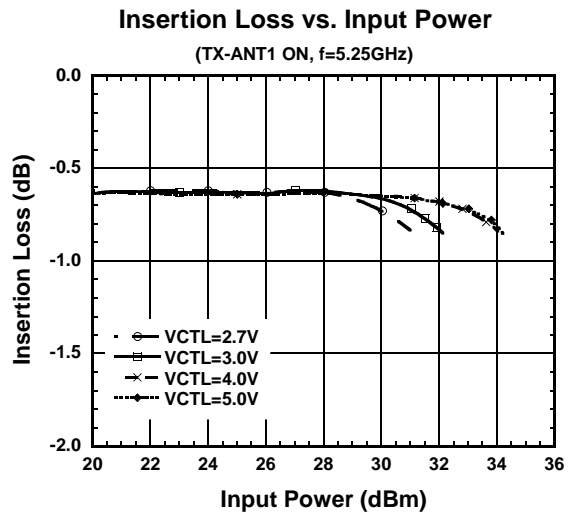
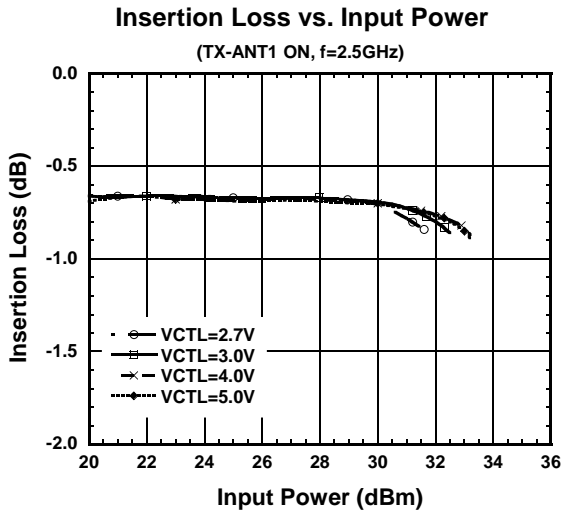

APPLICATION CIRCUIT

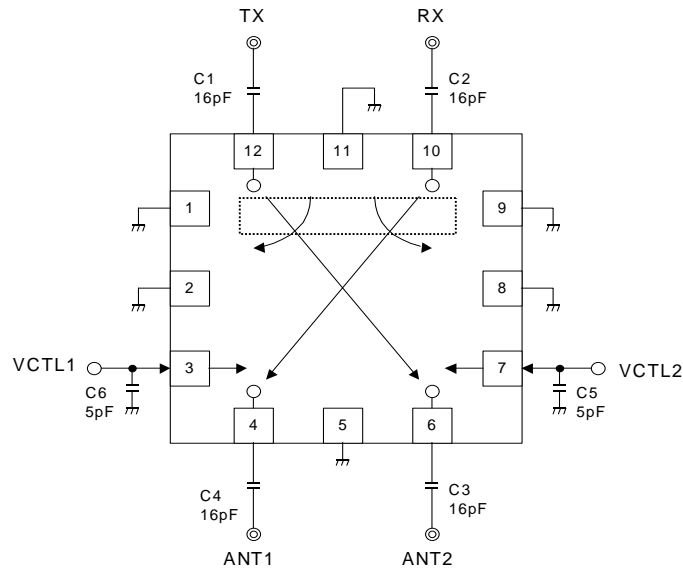

RECOMMENDED PCB DESIGN

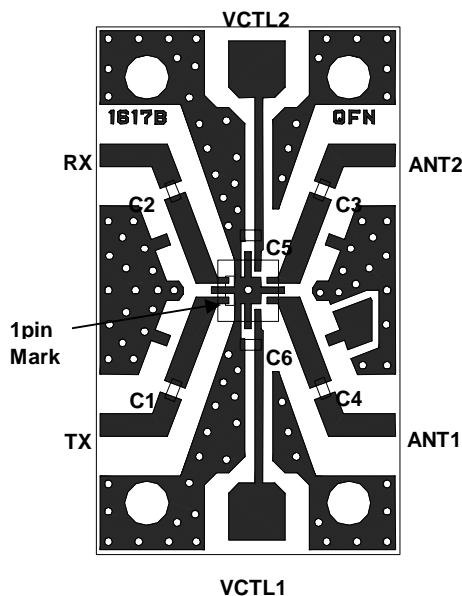

Total Losses of PCB, connector and DC blocking capacitor.

f	PPE	FR-4
2.5GHz	0.20dB	0.31dB
6.0GHz	0.41dB	0.67dB

PCB: PPE, t=0.5mm
 Capacitor: size 1005
 Strip line Width=1.1mm

PCB: FR4, t=0.5mm
 Capacitor: size 1005
 Strip line Width=1.0mm

PARTS LIST

Parts	List 1	List 2	Notes
	0.1~2.0GHz	2.0~6.0GHz	
C1~C4	39pF	16pF	MURATA GRM15
C5~C6	10pF	5pF	MURATA GRM15

PRECAUTIONS

- [1]The DC blocking capacitors have to be placed at RF terminal of RX, TX, ANT1 and ANT2.
- [2] Please locate bypass capacitors (C5,C6) close to appropriate terminals to reduce stripline influence on RF characteristics.
- [3]For good RF performance, the GND terminal must be placed close to ground plane of substrate, and through holes for GND should be placed near by the GND pin connection.
- [4]Exposed pad in the bottom must be connected to ground by via holes.

NJG1617K11

PACKAGE OUTLINE

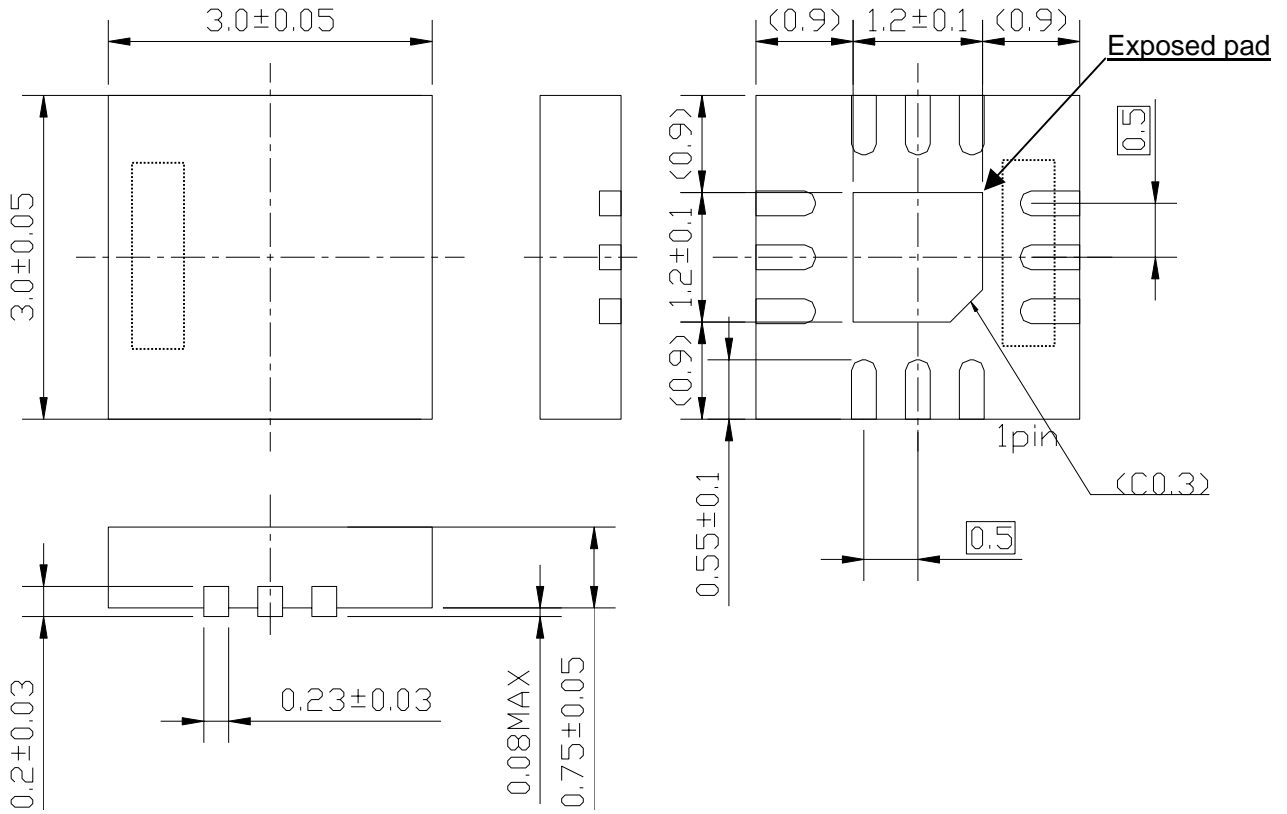

TERMINAL TREAT : Bi-Sn
 Molding material : Epoxy resin
 UNIT : mm
 WEIGHT : 20mg

Cautions on using this product

This product contains Gallium-Arsenide (GaAs) which is a harmful material.

- Do NOT eat or put into mouth.
- Do NOT dispose in fire or break up this product.
- Do NOT chemically make gas or powder with this product.
- To waste this product, please obey the relating law of your country.

[CAUTION]

The specifications on this databook are only given for information, without any guarantee as regards either mistakes or omissions. The application circuits in this databook are described only to show representative usages of the product and not intended for the guarantee or permission of any right including the industrial rights.

This product may be damaged with electric static discharge (ESD) or spike voltage. Please handle with care to avoid these damages.

Данный компонент на территории Российской Федерации

Вы можете приобрести в компании MosChip.

Для оперативного оформления запроса Вам необходимо перейти по данной ссылке:

<http://moschip.ru/get-element>

Вы можете разместить у нас заказ для любого Вашего проекта, будь то серийное производство или разработка единичного прибора.

В нашем ассортименте представлены ведущие мировые производители активных и пассивных электронных компонентов.

Нашей специализацией является поставка электронной компонентной базы двойного назначения, продукции таких производителей как XILINX, Intel (ex.ALTERA), Vicor, Microchip, Texas Instruments, Analog Devices, Mini-Circuits, Amphenol, Glenair.

Сотрудничество с глобальными дистрибьюторами электронных компонентов, предоставляет возможность заказывать и получать с международных складов практически любой перечень компонентов в оптимальные для Вас сроки.

На всех этапах разработки и производства наши партнеры могут получить квалифицированную поддержку опытных инженеров.

Система менеджмента качества компании отвечает требованиям в соответствии с ГОСТ Р ИСО 9001, ГОСТ РВ 0015-002 и ЭС РД 009

Офис по работе с юридическими лицами:

105318, г.Москва, ул.Щербаковская д.3, офис 1107, 1118, ДЦ «Щербаковский»

Телефон: +7 495 668-12-70 (многоканальный)

Факс: +7 495 668-12-70 (доб.304)

E-mail: info@moschip.ru

Skype отдела продаж:

moschip.ru

moschip.ru_4

moschip.ru_6

moschip.ru_9