

Super Junction MOSFET

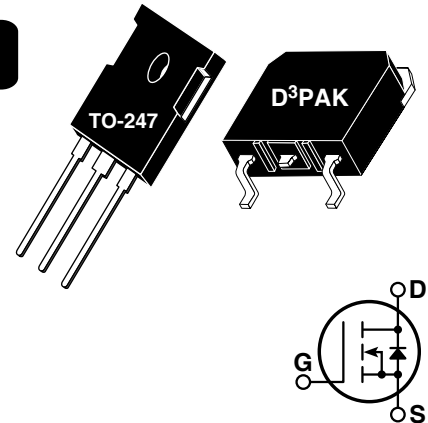

- Ultra low $R_{DS(ON)}$
- Low Miller Capacitance
- Ultra Low Gate Charge, Q_g
- Avalanche Energy Rated
- TO-247 or Surface Mount D³PAK Package



MAXIMUM RATINGS

All Ratings: $T_C = 25^\circ\text{C}$ unless otherwise specified.

Symbol	Parameter	APT47N60BC3_SC3	UNIT
V_{DSS}	Drain-Source Voltage	600	Volts
I_D	Continuous Drain Current @ $T_C = 25^\circ\text{C}$	47	Amps
I_{DM}	Pulsed Drain Current ^①	141	
V_{GS}	Gate-Source Voltage Continuous	± 20	Volts
V_{GSM}	Gate-Source Voltage Transient	± 30	
P_D	Total Power Dissipation @ $T_C = 25^\circ\text{C}$	417	Watts
	Linear Derating Factor	3.33	W/ $^\circ\text{C}$
T_J, T_{STG}	Operating and Storage Junction Temperature Range	-55 to 150	$^\circ\text{C}$
T_L	Lead Temperature: 0.063" from Case for 10 Sec.	260	
dv/dt	Drain-Source Voltage slope ($V_{DS} = 480\text{V}$, $I_D = 47\text{A}$, $T_J = 125^\circ\text{C}$)	50	V/ns
I_{AR}	Repetitive Avalanche Current ^⑦	20	Amps
E_{AR}	Repetitive Avalanche Energy ^⑦	1	mJ
E_{AS}	Single Pulse Avalanche Energy ^④	1800	

STATIC ELECTRICAL CHARACTERISTICS

Symbol	Characteristic / Test Conditions	MIN	TYP	MAX	UNIT
BV_{DSS}	Drain-Source Breakdown Voltage ($V_{GS} = 0\text{V}$, $I_D = 250\mu\text{A}$)	600			Volts
$R_{DS(on)}$	Drain-Source On-State Resistance ^② ($V_{GS} = 10\text{V}$, $I_D = 30\text{A}$)		0.06	0.07	Ohms
I_{DSS}	Zero Gate Voltage Drain Current ($V_{DS} = 600\text{V}$, $V_{GS} = 0\text{V}$)		0.5	25	μA
	Zero Gate Voltage Drain Current ($V_{DS} = 600\text{V}$, $V_{GS} = 0\text{V}$, $T_J = 150^\circ\text{C}$)			250	
I_{GSS}	Gate-Source Leakage Current ($V_{GS} = \pm 20\text{V}$, $V_{DS} = 0\text{V}$)			± 100	nA
$V_{GS(th)}$	Gate Threshold Voltage ($V_{DS} = V_{GS}$, $I_D = 2.7\text{mA}$)	2.10	3	3.9	Volts

 **CAUTION:** These Devices are Sensitive to Electrostatic Discharge. Proper Handling Procedures Should Be Followed.

APT Website - <http://www.advancedpower.com>

"COOLMOS™" comprise a new family of transistors developed by Infineon Technologies AG. "COOLMOS" is a trademark of Infineon Technologies AG"

DYNAMIC CHARACTERISTICS

APT47N60BC3_SC3

Symbol	Characteristic	Test Conditions	MIN	TYP	MAX	UNIT
C _{iss}	Input Capacitance	V _{GS} = 0V V _{DS} = 25V f = 1 MHz		7015		pF
C _{oss}	Output Capacitance			2565		
C _{rss}	Reverse Transfer Capacitance			210		
Q _g	Total Gate Charge ③	V _{GS} = 10V V _{DD} = 300V I _D = 47A @ 25°C		260		nC
Q _{gs}	Gate-Source Charge			29		
Q _{gd}	Gate-Drain ("Miller") Charge			110		
t _{d(on)}	Turn-on Delay Time	RESISTIVE SWITCHING V _{GS} = 13V V _{DD} = 380V I _D = 47A @ 125°C R _G = 1.8Ω		18		ns
t _r	Rise Time			27		
t _{d(off)}	Turn-off Delay Time			110		
t _f	Fall Time			8		
E _{on}	Turn-on Switching Energy ⑥	INDUCTIVE SWITCHING @ 25°C V _{DD} = 400V, V _{GS} = 15V I _D = 47A, R _G = 5Ω		670		μJ
E _{off}	Turn-off Switching Energy			980		
E _{on}	Turn-on Switching Energy ⑥	INDUCTIVE SWITCHING @ 125°C V _{DD} = 400V V _{GS} = 15V I _D = 47A, R _G = 5Ω		1100		
E _{off}	Turn-off Switching Energy			1200		

SOURCE-DRAIN DIODE RATINGS AND CHARACTERISTICS

Symbol	Characteristic / Test Conditions	MIN	TYP	MAX	UNIT
I _S	Continuous Source Current (Body Diode)			47	Amps
I _{SM}	Pulsed Source Current ① (Body Diode)			141	
V _{SD}	Diode Forward Voltage ② (V _{GS} = 0V, I _S = -47A)			1.2	Volts
t _{rr}	Reverse Recovery Time (I _S = -47A, di _S /dt = 100A/μs, V _R = 350V)		580		ns
Q _{rr}	Reverse Recovery Charge (I _S = -47A, di _S /dt = 100A/μs, V _R = 350V)		23		μC
dv/dt	Peak Diode Recovery dv/dt ⑤			6	V/ns

THERMAL CHARACTERISTICS

Symbol	Characteristic	MIN	TYP	MAX	UNIT
R _{θJC}	Junction to Case			0.30	°C/W
R _{θJA}	Junction to Ambient			62	

- ① Repetitive Rating: Pulse width limited by maximum junction temperature
- ② Pulse Test: Pulse width < 380 μs, Duty Cycle < 2%
- ③ See MIL-STD-750 Method 3471
- ④ Starting T_J = +25°C, L = 36.0mH, R_G = 25Ω, Peak I_L = 10A
- ⑤ dv/dt numbers reflect the limitations of the test circuit rather than the device itself. I_S ≤ -I_D47A di/dt ≤ 700A/μs v_R ≤ v_{DSS} T_J ≤ 150°C
- ⑥ Eon includes diode reverse recovery. See figures 18, 20.
- ⑦ Repetitive avalanche causes additional power losses that can be calculated as P_{AV} = E_{AR} * f

APT Reserves the right to change, without notice, the specifications and information contained herein.

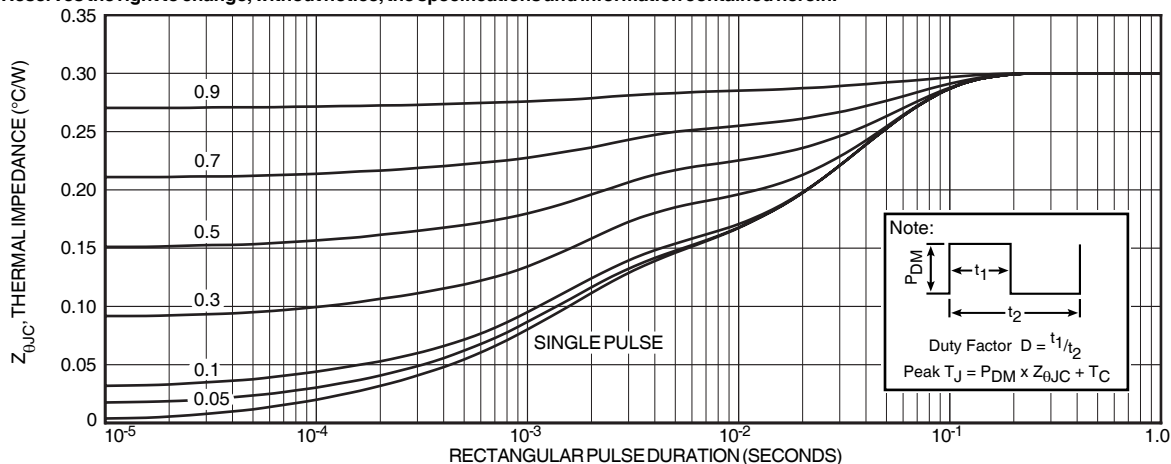

FIGURE 1, MAXIMUM EFFECTIVE TRANSIENT THERMAL IMPEDANCE, JUNCTION-TO-CASE vs PULSE DURATION

Typical Performance Curves

APT47N60BC3_SC3

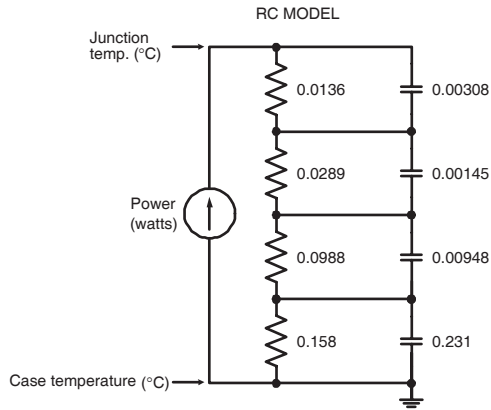

FIGURE 2, TRANSIENT THERMAL IMPEDANCE MODEL

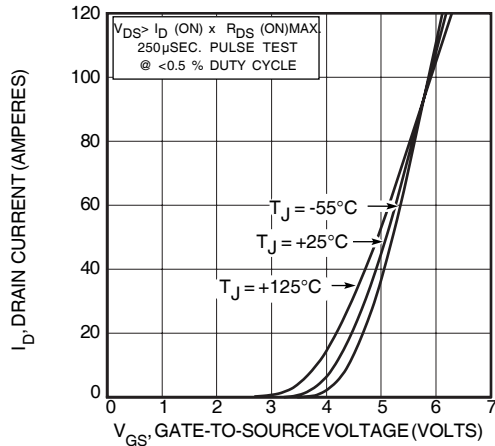

FIGURE 4, TRANSFER CHARACTERISTICS

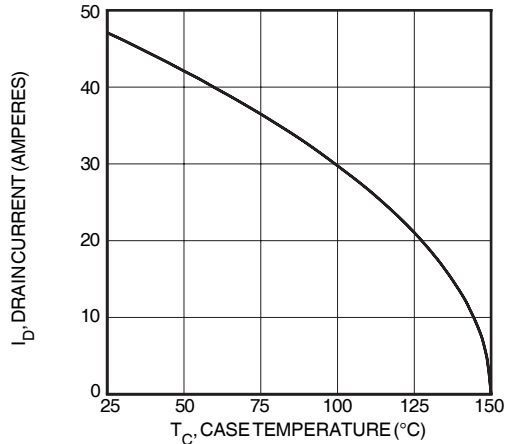

FIGURE 6, MAXIMUM DRAIN CURRENT vs CASE TEMPERATURE

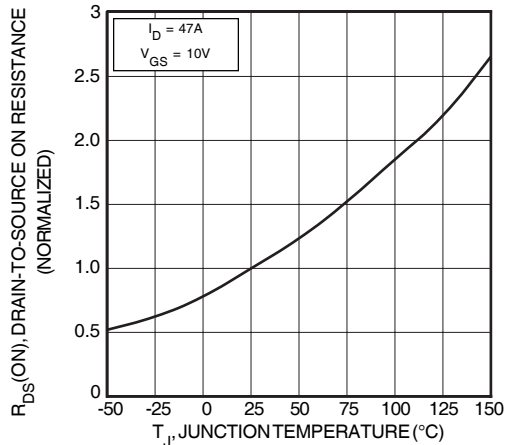

FIGURE 8, ON-RESISTANCE vs. TEMPERATURE

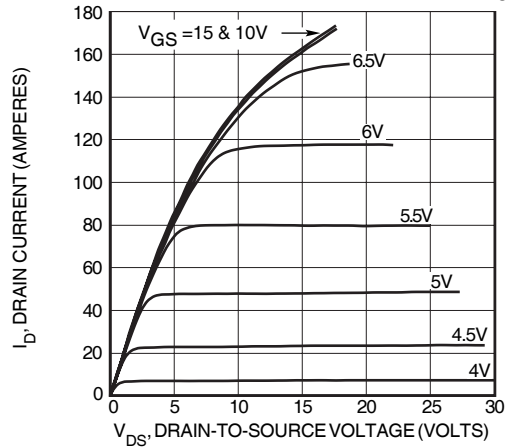

FIGURE 3, LOW VOLTAGE OUTPUT CHARACTERISTICS

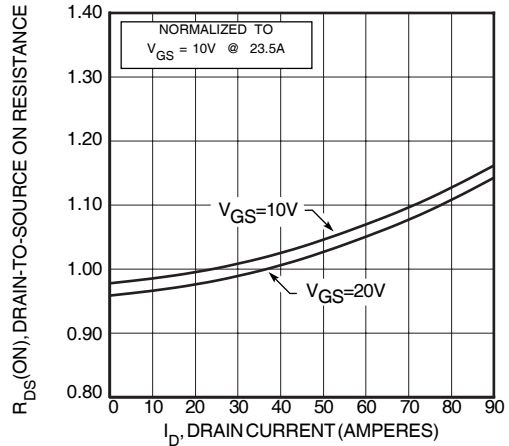

FIGURE 5, $R_{DS(ON)}$ vs DRAIN CURRENT

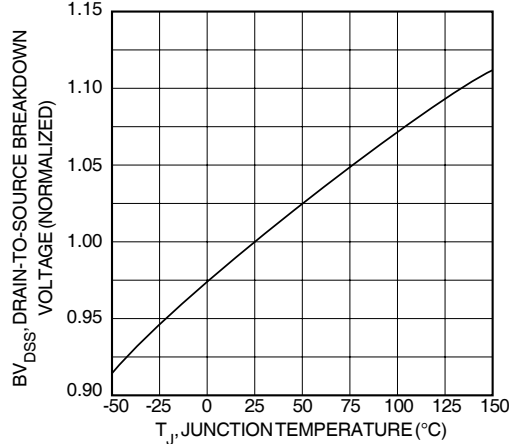

FIGURE 7, BREAKDOWN VOLTAGE vs TEMPERATURE

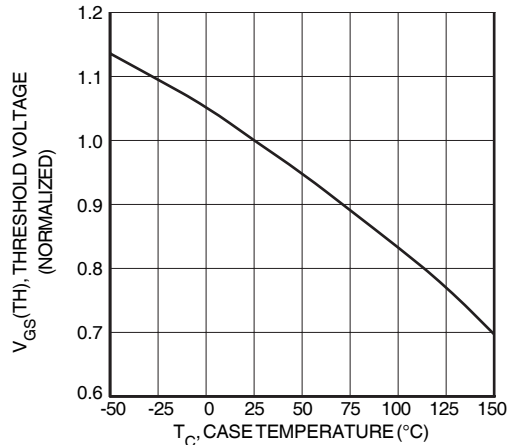

FIGURE 9, THRESHOLD VOLTAGE vs TEMPERATURE

Typical Performance Curves

APT47N60BC3_SC3

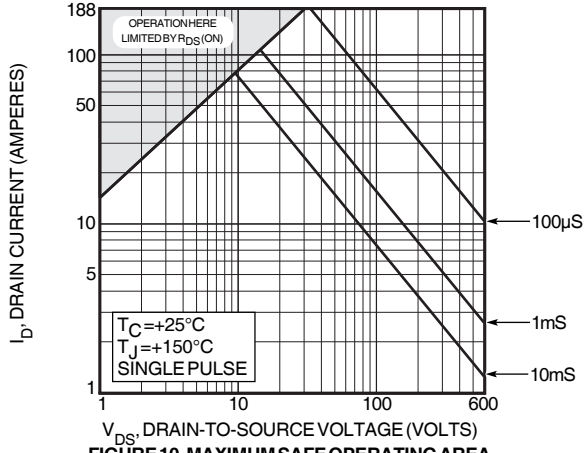

FIGURE 10, MAXIMUM SAFE OPERATING AREA

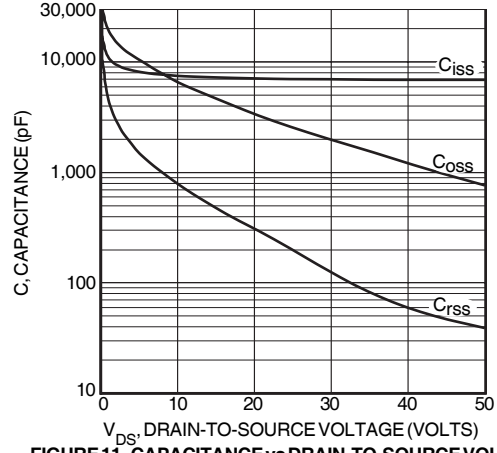

FIGURE 11, CAPACITANCE vs DRAIN-TO-SOURCE VOLTAGE

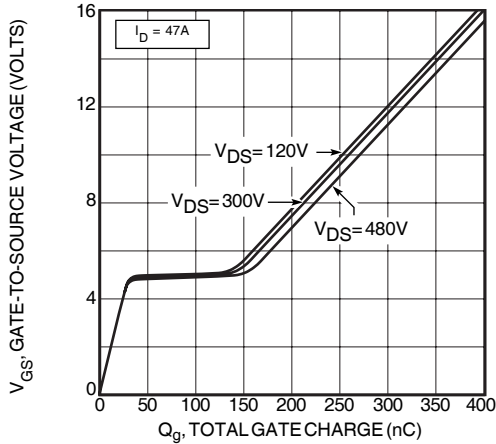

FIGURE 12, GATE CHARGES vs GATE-TO-SOURCE VOLTAGE

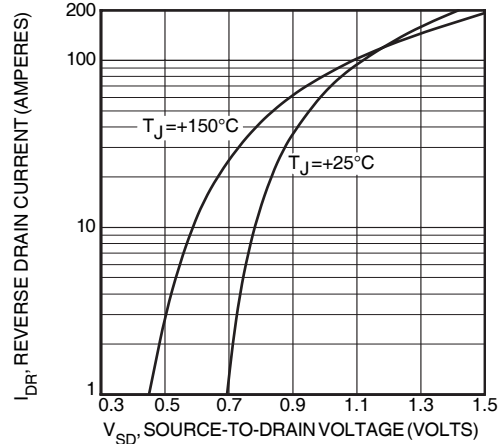

FIGURE 13, SOURCE-DRAIN DIODE FORWARD VOLTAGE

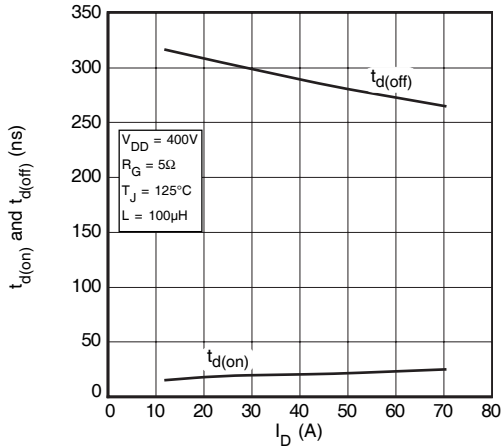

FIGURE 14, DELAY TIMES vs CURRENT

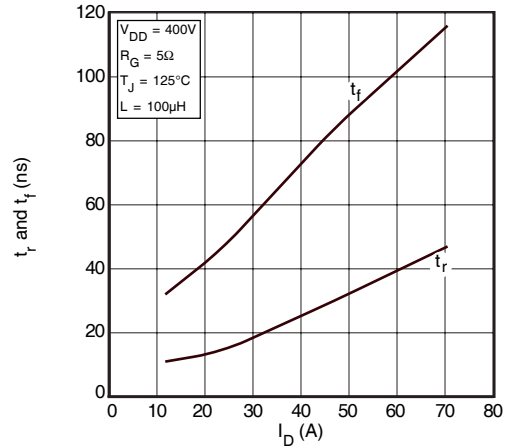

FIGURE 15, RISE AND FALL TIMES vs CURRENT

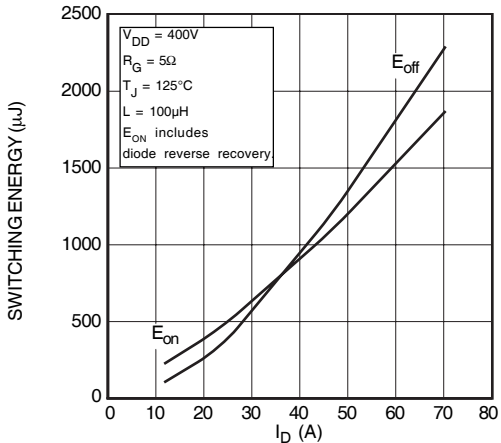

FIGURE 16, SWITCHING ENERGY vs CURRENT

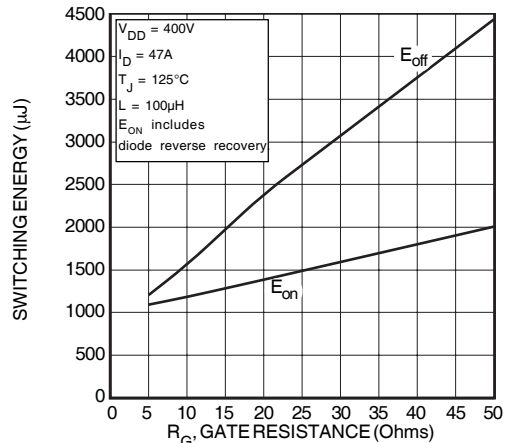

FIGURE 17, SWITCHING ENERGY vs. GATE RESISTANCE

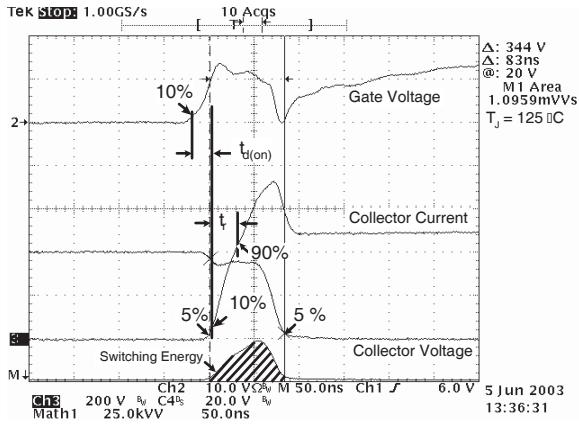

Figure 18, Turn-on Switching Waveforms and Definitions

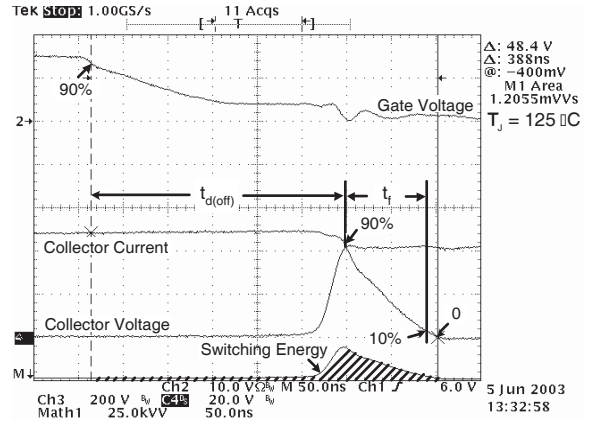

Figure 19, Turn-off Switching Waveforms and Definitions

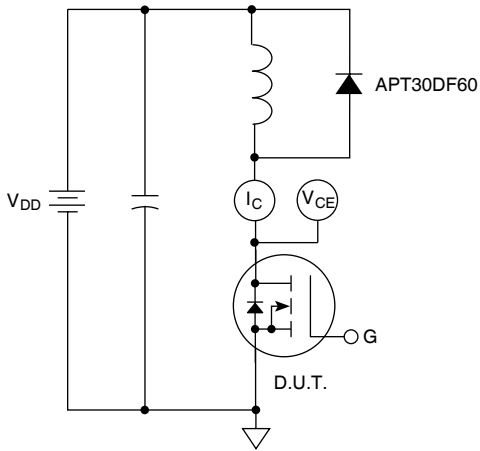
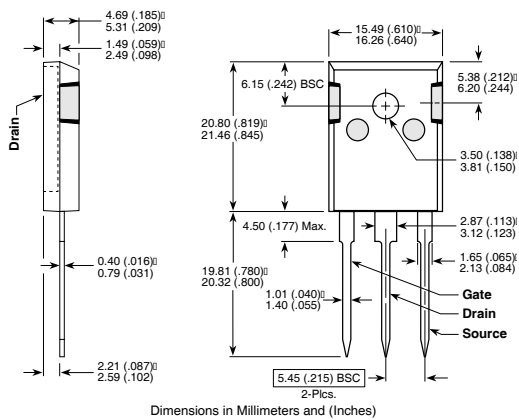
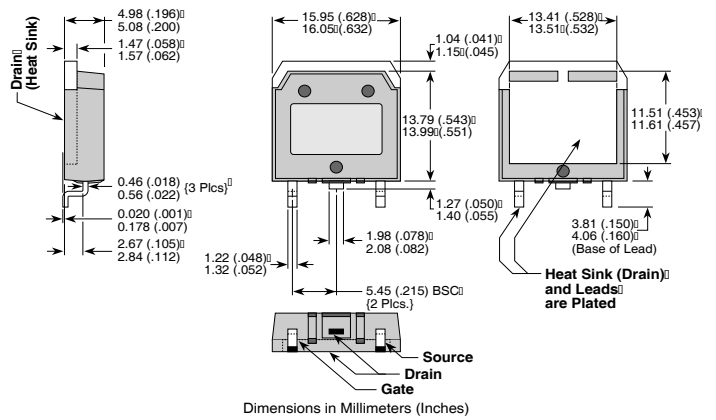

Figure 20, Inductive Switching Test Circuit

TO-247 Package Outline



D³PAK Package Outline



APT's products are covered by one or more of U.S. patents 4,895,810 5,045,903 5,089,434 5,182,234 5,019,522 5,262,336 6,503,786 5,256,583 4,748,103 5,283,202 5,231,474 5,434,095 5,528,058 and foreign patents. US and Foreign patents pending. All Rights Reserved.

Данный компонент на территории Российской Федерации

Вы можете приобрести в компании MosChip.

Для оперативного оформления запроса Вам необходимо перейти по данной ссылке:

<http://moschip.ru/get-element>

Вы можете разместить у нас заказ для любого Вашего проекта, будь то серийное производство или разработка единичного прибора.

В нашем ассортименте представлены ведущие мировые производители активных и пассивных электронных компонентов.

Нашей специализацией является поставка электронной компонентной базы двойного назначения, продукции таких производителей как XILINX, Intel (ex.ALTERA), Vicor, Microchip, Texas Instruments, Analog Devices, Mini-Circuits, Amphenol, Glenair.

Сотрудничество с глобальными дистрибьюторами электронных компонентов, предоставляет возможность заказывать и получать с международных складов практически любой перечень компонентов в оптимальные для Вас сроки.

На всех этапах разработки и производства наши партнеры могут получить квалифицированную поддержку опытных инженеров.

Система менеджмента качества компании отвечает требованиям в соответствии с ГОСТ Р ИСО 9001, ГОСТ РВ 0015-002 и ЭС РД 009

Офис по работе с юридическими лицами:

105318, г.Москва, ул.Щербаковская д.3, офис 1107, 1118, ДЦ «Щербаковский»

Телефон: +7 495 668-12-70 (многоканальный)

Факс: +7 495 668-12-70 (доб.304)

E-mail: info@moschip.ru

Skype отдела продаж:

moschip.ru

moschip.ru_4

moschip.ru_6

moschip.ru_9