

# MC14012B

## Dual 4-Input NAND Gates

The MC14012B dual 4-input NAND gates are constructed with P-Channel and N-Channel enhancement mode devices in a single monolithic structure (Complementary MOS). Their primary use is where low power dissipation and/or high noise immunity is desired.

### Features

- Supply Voltage Range = 3.0 Vdc to 18 Vdc
- All Outputs Buffered
- Capable of Driving Two Low-Power TTL Loads or One Low-Power Schottky TTL Load Over the Rated Temperature Range
- Double Diode Protection on All Inputs
- Pin-for-Pin Replacements for Corresponding CD4000 Series B Suffix Devices
- These Devices are Pb-Free and are RoHS Compliant

### MAXIMUM RATINGS (Voltages Referenced to $V_{SS}$ )

Symbol	Parameter	Value	Unit
$V_{DD}$	DC Supply Voltage Range	-0.5 to +18.0	V
$V_{in}, V_{out}$	Input or Output Voltage Range (DC or Transient)	-0.5 to $V_{DD} + 0.5$	V
$I_{in}, I_{out}$	Input or Output Current (DC or Transient) per Pin	$\pm 10$	mA
$P_D$	Power Dissipation, per Package (Note 1)	500	mW
$T_A$	Ambient Temperature Range	-55 to +125	$^{\circ}C$
$T_{stg}$	Storage Temperature Range	-65 to +150	$^{\circ}C$
$T_L$	Lead Temperature (8-Second Soldering)	260	$^{\circ}C$

Stresses exceeding Maximum Ratings may damage the device. Maximum Ratings are stress ratings only. Functional operation above the Recommended Operating Conditions is not implied. Extended exposure to stresses above the Recommended Operating Conditions may affect device reliability.

#### 1. Temperature Derating:

Plastic "P and D/DW" Packages: - 7.0 mW/ $^{\circ}C$  From 65 $^{\circ}C$  To 125 $^{\circ}C$

This device contains protection circuitry to guard against damage due to high static voltages or electric fields. However, precautions must be taken to avoid applications of any voltage higher than maximum rated voltages to this high-impedance circuit. For proper operation,  $V_{in}$  and  $V_{out}$  should be constrained to the range  $V_{SS} \leq (V_{in} \text{ or } V_{out}) \leq V_{DD}$ .

Unused inputs must always be tied to an appropriate logic voltage level (e.g., either  $V_{SS}$  or  $V_{DD}$ ). Unused outputs must be left open.



ON Semiconductor®

<http://onsemi.com>

### MARKING DIAGRAMS

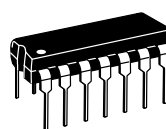

PDIP-14  
P SUFFIX  
CASE 646

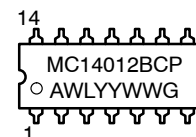

SOIC-14  
D SUFFIX  
CASE 751A

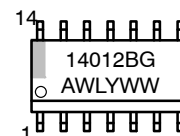

A = Assembly Location  
WL, L = Wafer Lot  
YY, Y = Year  
WW, W = Work Week  
G = Pb-Free Package

### ORDERING INFORMATION

See detailed ordering and shipping information in the package dimensions section on page 2 of this data sheet.

# MC14012B

## MC14012B Dual 4-Input NAND Gate

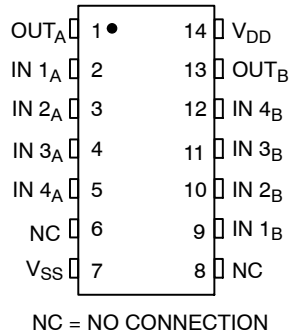

Figure 1. Pin Assignment

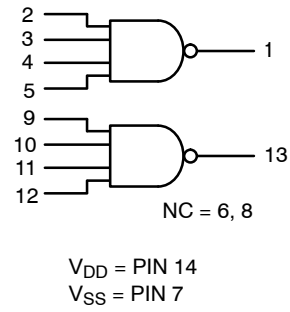

Figure 2. Logic Diagram

### ORDERING INFORMATION

Device	Package	Shipping <sup>†</sup>
MC14012BCPG	PDIP-14 (Pb-Free)	25 Units / Rail
MC14012BDG	SOIC-14 (Pb-Free)	55 Units / Rail
MC14012BDR2G	SOIC-14 (Pb-Free)	2500 Units / Tape & Reel

<sup>†</sup>For information on tape and reel specifications, including part orientation and tape sizes, please refer to our Tape and Reel Packaging Specifications Brochure, BRD8011/D.

# MC14012B

## ELECTRICAL CHARACTERISTICS (Voltages Referenced to $V_{SS}$ )

Characteristic	Symbol	$V_{DD}$ Vdc	- 55°C		25°C			125°C		Unit
			Min	Max	Min	Typ (Note 2)	Max	Min	Max	
Output Voltage $V_{in} = V_{DD}$ or 0  $V_{in} = 0$ or $V_{DD}$	"0" Level  $V_{OL}$	5.0	-	0.05	-	0	0.05	-	0.05	Vdc
		10	-	0.05	-	0	0.05	-	0.05	
		15	-	0.05	-	0	0.05	-	0.05	
	"1" Level  $V_{OH}$	5.0	4.95	-	4.95	5.0	-	4.95	-	Vdc
		10	9.95	-	9.95	10	-	9.95	-	
		15	14.95	-	14.95	15	-	14.95	-	
Input Voltage $(V_O = 4.5$ or $0.5$ Vdc) $(V_O = 9.0$ or $1.0$ Vdc) $(V_O = 13.5$ or $1.5$ Vdc)  $(V_O = 0.5$ or $4.5$ Vdc) $(V_O = 1.0$ or $9.0$ Vdc) $(V_O = 1.5$ or $13.5$ Vdc)	"0" Level  $V_{IL}$	5.0	-	1.5	-	2.25	1.5	-	1.5	Vdc
		10	-	3.0	-	4.50	3.0	-	3.0	
		15	-	4.0	-	6.75	4.0	-	4.0	
	"1" Level  $V_{IH}$	5.0	3.5	-	3.5	2.75	-	3.5	-	Vdc
		10	7.0	-	7.0	5.50	-	7.0	-	
		15	11	-	11	8.25	-	11	-	
Output Drive Current $(V_{OH} = 2.5$ Vdc) $(V_{OH} = 4.6$ Vdc) $(V_{OH} = 9.5$ Vdc) $(V_{OH} = 13.5$ Vdc)  $(V_{OL} = 0.4$ Vdc) $(V_{OL} = 0.5$ Vdc) $(V_{OL} = 1.5$ Vdc)	Source  $I_{OH}$	5.0	-3.0	-	-2.4	-4.2	-	-1.7	-	mAdc
		5.0	-0.64	-	-0.51	-0.88	-	-0.36	-	
		10	-1.6	-	-1.3	-2.25	-	-0.9	-	
		15	-4.2	-	-3.4	-8.8	-	-2.4	-	
	Sink  $I_{OL}$	5.0	0.64	-	0.51	0.88	-	0.36	-	mAdc
		10	1.6	-	1.3	2.25	-	0.9	-	
15		4.2	-	3.4	8.8	-	2.4	-		
Input Current	$I_{in}$	15	-	$\pm 0.1$	-	$\pm 0.00001$	$\pm 0.1$	-	$\pm 1.0$	$\mu$ Adc
Input Capacitance $(V_{in} = 0)$	$C_{in}$	-	-	-	-	5.0	7.5	-	-	pF
Quiescent Current (Per Package)	$I_{DD}$	5.0	-	0.25	-	0.0005	0.25	-	7.5	$\mu$ Adc
		10	-	0.5	-	0.0010	0.5	-	15	
		15	-	1.0	-	0.0015	1.0	-	30	
Total Supply Current (Notes 3, 4) (Dynamic plus Quiescent, Per Gate, $C_L = 50$ pF)	$I_T$	5.0	$I_T = (0.3 \mu A/kHz) f + I_{DD}/N$							$\mu$ Adc
		10	$I_T = (0.6 \mu A/kHz) f + I_{DD}/N$							
		15	$I_T = (0.9 \mu A/kHz) f + I_{DD}/N$							

2. Data labelled "Typ" is not to be used for design purposes but is intended as an indication of the IC's potential performance.
3. The formulas given are for the typical characteristics only at 25°C.
4. To calculate total supply current at loads other than 50 pF:

$$I_T(C_L) = I_T(50 \text{ pF}) + (C_L - 50) Vfk$$

where:  $I_T$  is in  $\mu A$  (per package),  $C_L$  in pF,  $V = (V_{DD} - V_{SS})$  in volts,  $f$  in kHz is input frequency, and  $k = 0.001 \times$  the number of exercised gates per package.

# MC14012B

## SWITCHING CHARACTERISTICS (Note 5) ( $C_L = 50 \text{ pF}$ , $T_A = 25^\circ\text{C}$ )

Characteristic	Symbol	$V_{DD}$ Vdc	Min	Typ (Note 6)	Max	Unit
Output Rise Time $t_{TLH} = (1.35 \text{ ns/pF}) C_L + 33 \text{ ns}$ $t_{TLH} = (0.60 \text{ ns/pF}) C_L + 20 \text{ ns}$ $t_{TLH} = (0.40 \text{ ns/pF}) C_L + 20 \text{ ns}$	$t_{TLH}$	5.0 10 15	- - -	100 50 40	200 100 80	ns
Output Fall Time $t_{THL} = (1.35 \text{ ns/pF}) C_L + 33 \text{ ns}$ $t_{THL} = (0.60 \text{ ns/pF}) C_L + 20 \text{ ns}$ $t_{THL} = (0.40 \text{ ns/pF}) C_L + 20 \text{ ns}$	$t_{THL}$	5.0 10 15	- - -	100 50 40	200 100 80	ns
Propagation Delay Time $t_{PLH}, t_{PHL} = (0.90 \text{ ns/pF}) C_L + 115 \text{ ns}$ $t_{PLH}, t_{PHL} = (0.36 \text{ ns/pF}) C_L + 47 \text{ ns}$ $t_{PLH}, t_{PHL} = (0.26 \text{ ns/pF}) C_L + 37 \text{ ns}$	$t_{PLH}, t_{PHL}$	5.0 10 15	- - -	160 65 50	300 130 100	ns

5. The formulas given are for the typical characteristics only at 25°C.

6. Data labelled "Typ" is not to be used for design purposes but is intended as an indication of the IC's potential performance.

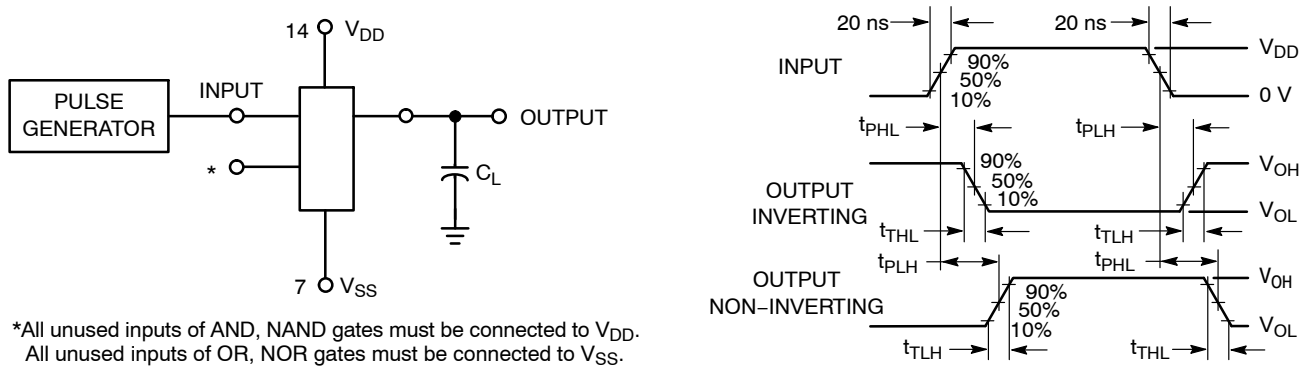

\*All unused inputs of AND, NAND gates must be connected to  $V_{DD}$ .  
 All unused inputs of OR, NOR gates must be connected to  $V_{SS}$ .

Figure 3. Switching Time Test Circuit and Waveforms

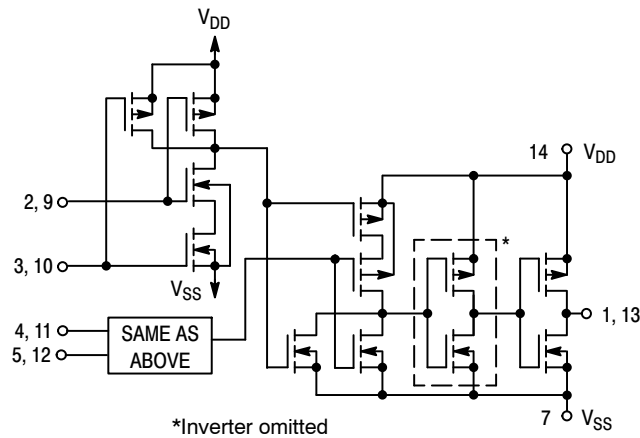

Figure 4. Circuit Schematic - One of Two Gates Shown

TYPICAL B-SERIES GATE CHARACTERISTICS

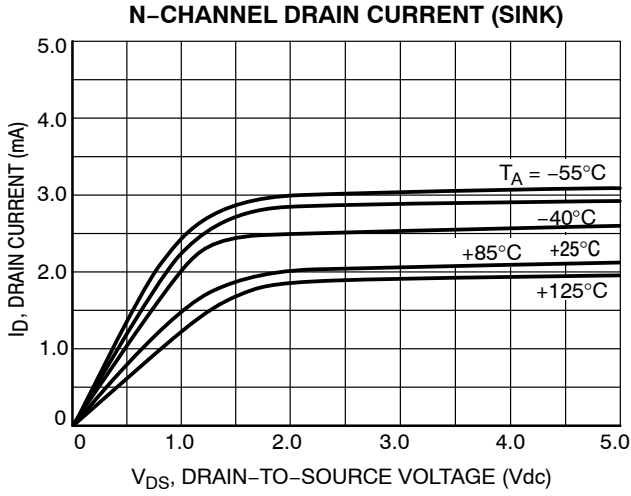

Figure 5.  $V_{GS} = 5.0$  Vdc

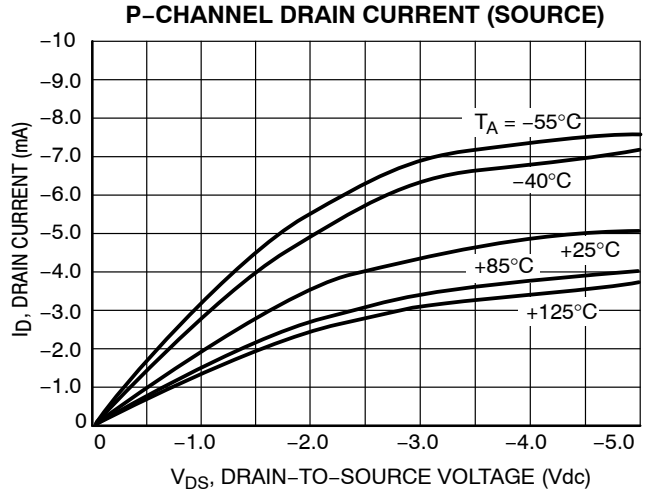

Figure 6.  $V_{GS} = -5.0$  Vdc

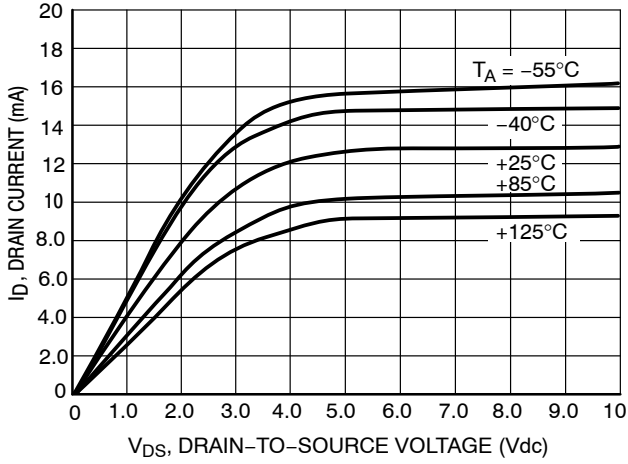

Figure 7.  $V_{GS} = 10$  Vdc

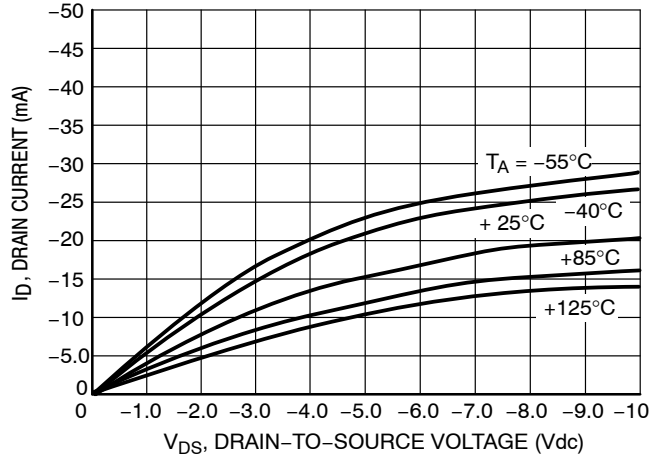

Figure 8.  $V_{GS} = -10$  Vdc

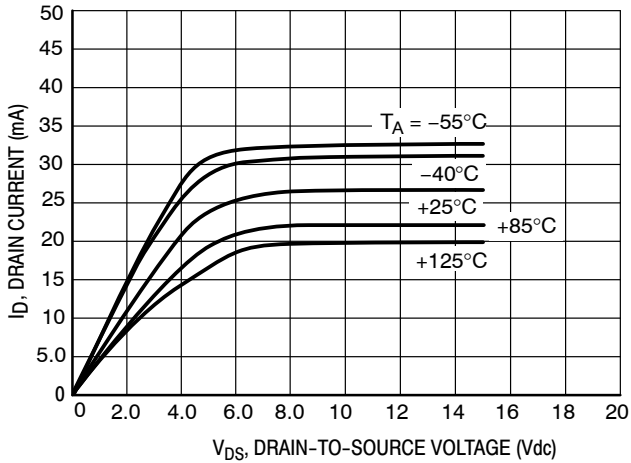

Figure 9.  $V_{GS} = 15$  Vdc

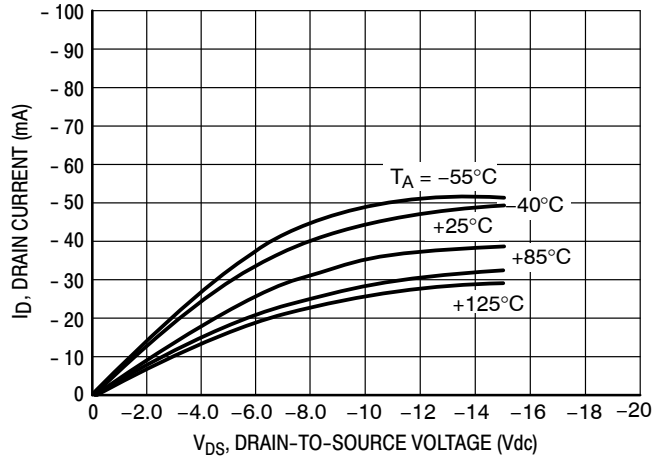

Figure 10.  $V_{GS} = -15$  Vdc

These typical curves are not guarantees, but are design aids.  
 Caution: The maximum rating for output current is 10 mA per pin.

VOLTAGE TRANSFER CHARACTERISTICS

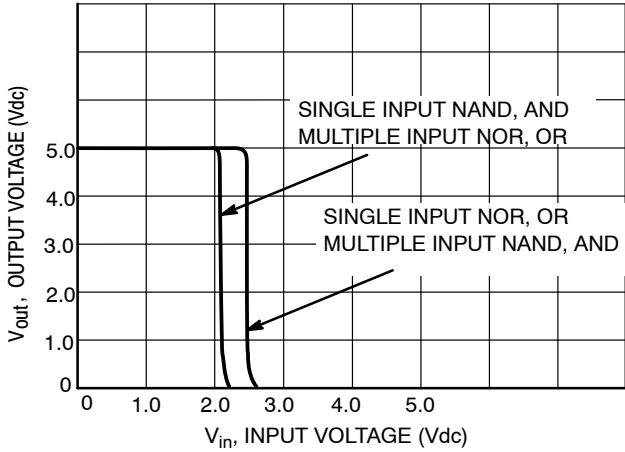

Figure 11.  $V_{DD} = 5.0 \text{ Vdc}$

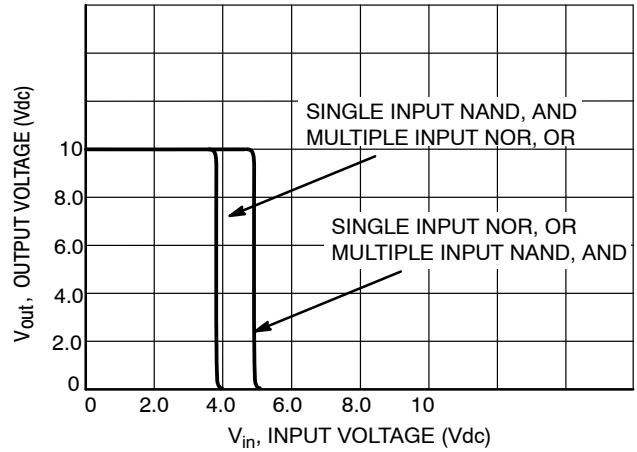

Figure 12.  $V_{DD} = 10 \text{ Vdc}$

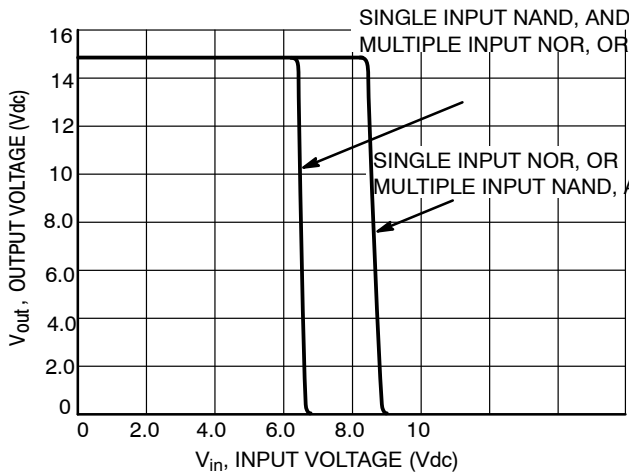

Figure 13.  $V_{DD} = 15 \text{ Vdc}$

DC NOISE MARGIN

The DC noise margin is defined as the input voltage range from an ideal “1” or “0” input level which does not produce output state change(s). The typical and guaranteed limit values of the input values  $V_{IL}$  and  $V_{IH}$  for the output(s) to be at a fixed voltage  $V_O$  are given in the Electrical Characteristics table.  $V_{IL}$  and  $V_{IH}$  are presented graphically in Figure 11.

Guaranteed minimum noise margins for both the “1” and “0” levels =

- 1.0 V with a 5.0 V supply
- 2.0 V with a 10.0 V supply
- 2.5 V with a 15.0 V supply

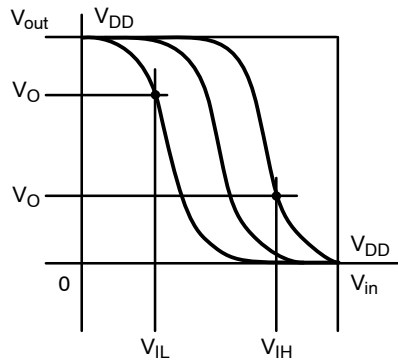

(a) Inverting Function

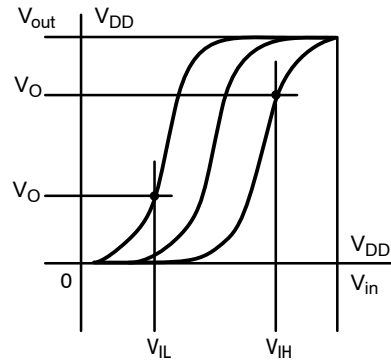

(b) Non-Inverting Function

$V_{SS} = 0 \text{ VOLTS DC}$

Figure 14. DC Noise Immunity

# MC14012B

## PACKAGE DIMENSIONS

**PDIP-14**  
CASE 646-06  
ISSUE P

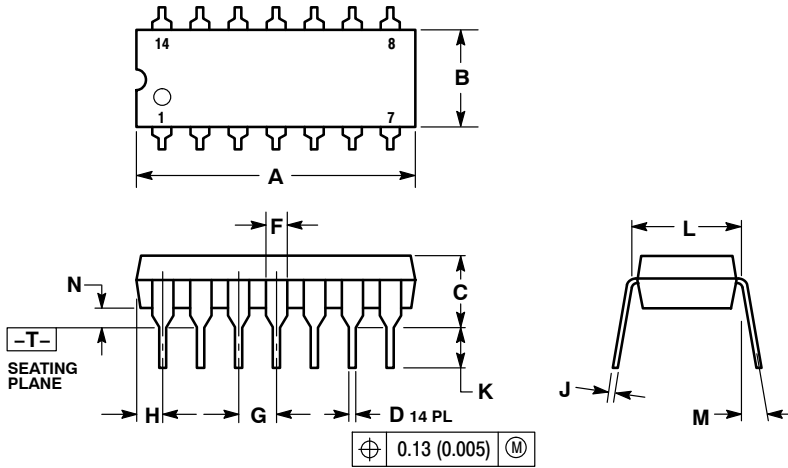

**NOTES:**

1. DIMENSIONING AND TOLERANCING PER ANSI Y14.5M, 1982.
2. CONTROLLING DIMENSION: INCH.
3. DIMENSION L TO CENTER OF LEADS WHEN FORMED PARALLEL.
4. DIMENSION B DOES NOT INCLUDE MOLD FLASH.
5. ROUNDED CORNERS OPTIONAL.

DIM	INCHES		MILLIMETERS	
	MIN	MAX	MIN	MAX
A	0.715	0.770	18.16	19.56
B	0.240	0.260	6.10	6.60
C	0.145	0.185	3.69	4.69
D	0.015	0.021	0.38	0.53
F	0.040	0.070	1.02	1.78
G	0.100 BSC		2.54 BSC	
H	0.052	0.095	1.32	2.41
J	0.008	0.015	0.20	0.38
K	0.115	0.135	2.92	3.43
L	0.290	0.310	7.37	7.87
M	---	10°	---	10°
N	0.015	0.039	0.38	1.01

# MC14012B

## PACKAGE DIMENSIONS

SOIC-14 NB  
CASE 751A-03  
ISSUE K

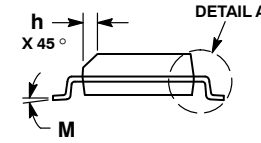
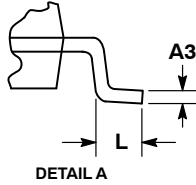
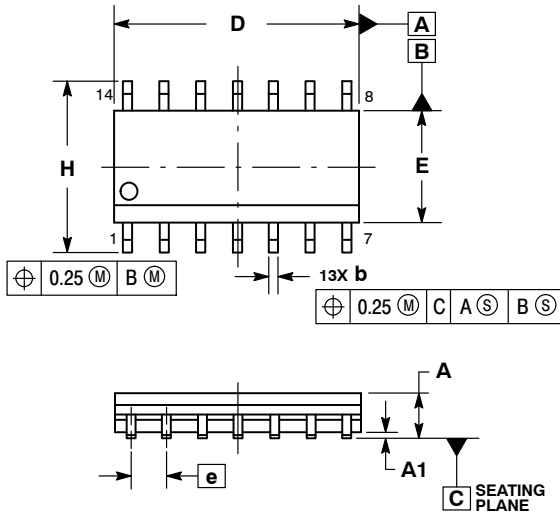

**NOTES:**

1. DIMENSIONING AND TOLERANCING PER ASME Y14.5M, 1994.
2. CONTROLLING DIMENSION: MILLIMETERS.
3. DIMENSION b DOES NOT INCLUDE DAMBAR PROTRUSION. ALLOWABLE PROTRUSION SHALL BE 0.13 TOTAL IN EXCESS OF AT MAXIMUM MATERIAL CONDITION.
4. DIMENSIONS D AND E DO NOT INCLUDE MOLD PROTRUSIONS.
5. MAXIMUM MOLD PROTRUSION 0.15 PER SIDE.

DIM	MILLIMETERS		INCHES	
	MIN	MAX	MIN	MAX
A	1.35	1.75	0.054	0.068
A1	0.10	0.25	0.004	0.010
A3	0.19	0.25	0.008	0.010
b	0.35	0.49	0.014	0.019
D	8.55	8.75	0.337	0.344
E	3.80	4.00	0.150	0.157
e	1.27 BSC		0.050 BSC	
H	5.80	6.20	0.228	0.244
h	0.25	0.50	0.010	0.019
L	0.40	1.25	0.016	0.049
M	0°	7°	0°	7°

### SOLDERING FOOTPRINT\*

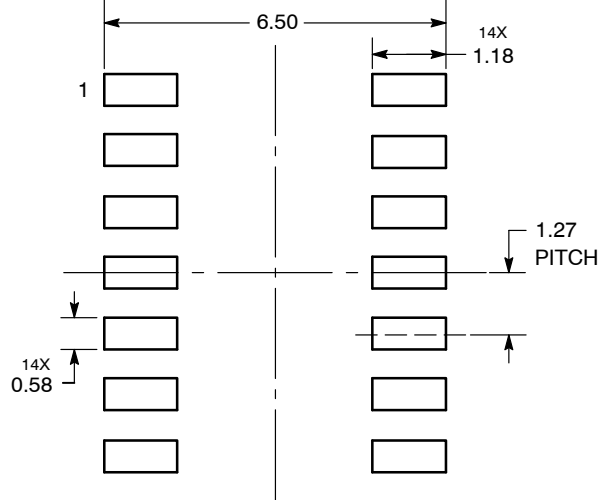

DIMENSIONS: MILLIMETERS

\*For additional information on our Pb-Free strategy and soldering details, please download the ON Semiconductor Soldering and Mounting Techniques Reference Manual, SOLDERRM/D.

ON Semiconductor and are registered trademarks of Semiconductor Components Industries, LLC (SCILLC). SCILLC reserves the right to make changes without further notice to any products herein. SCILLC makes no warranty, representation or guarantee regarding the suitability of its products for any particular purpose, nor does SCILLC assume any liability arising out of the application or use of any product or circuit, and specifically disclaims any and all liability, including without limitation special, consequential or incidental damages. "Typical" parameters which may be provided in SCILLC data sheets and/or specifications can and do vary in different applications and actual performance may vary over time. All operating parameters, including "Typicals" must be validated for each customer application by customer's technical experts. SCILLC does not convey any license under its patent rights nor the rights of others. SCILLC products are not designed, intended, or authorized for use as components in systems intended for surgical implant into the body, or other applications intended to support or sustain life, or for any other application in which the failure of the SCILLC product could create a situation where personal injury or death may occur. Should Buyer purchase or use SCILLC products for any such unintended or unauthorized application, Buyer shall indemnify and hold SCILLC and its officers, employees, subsidiaries, affiliates, and distributors harmless against all claims, costs, damages, and expenses, and reasonable attorney fees arising out of, directly or indirectly, any claim of personal injury or death associated with such unintended or unauthorized use, even if such claim alleges that SCILLC was negligent regarding the design or manufacture of the part. SCILLC is an Equal Opportunity/Affirmative Action Employer. This literature is subject to all applicable copyright laws and is not for resale in any manner.

### PUBLICATION ORDERING INFORMATION

**LITERATURE FULFILLMENT:**  
Literature Distribution Center for ON Semiconductor  
P.O. Box 5163, Denver, Colorado 80217 USA  
**Phone:** 303-675-2175 or 800-344-3860 Toll Free USA/Canada  
**Fax:** 303-675-2176 or 800-344-3867 Toll Free USA/Canada  
**Email:** orderlit@onsemi.com

**N. American Technical Support:** 800-282-9855 Toll Free USA/Canada  
**Europe, Middle East and Africa Technical Support:**  
Phone: 421 33 790 2910  
**Japan Customer Focus Center**  
Phone: 81-3-5773-3850

**ON Semiconductor Website:** [www.onsemi.com](http://www.onsemi.com)  
**Order Literature:** <http://www.onsemi.com/orderlit>  
For additional information, please contact your local Sales Representative



## Данный компонент на территории Российской Федерации

### Вы можете приобрести в компании MosChip.

Для оперативного оформления запроса Вам необходимо перейти по данной ссылке:

<http://moschip.ru/get-element>

Вы можете разместить у нас заказ для любого Вашего проекта, будь то серийное производство или разработка единичного прибора.

В нашем ассортименте представлены ведущие мировые производители активных и пассивных электронных компонентов.

Нашей специализацией является поставка электронной компонентной базы двойного назначения, продукции таких производителей как XILINX, Intel (ex.ALTERA), Vicor, Microchip, Texas Instruments, Analog Devices, Mini-Circuits, Amphenol, Glenair.

Сотрудничество с глобальными дистрибьюторами электронных компонентов, предоставляет возможность заказывать и получать с международных складов практически любой перечень компонентов в оптимальные для Вас сроки.

На всех этапах разработки и производства наши партнеры могут получить квалифицированную поддержку опытных инженеров.

Система менеджмента качества компании отвечает требованиям в соответствии с ГОСТ Р ИСО 9001, ГОСТ РВ 0015-002 и ЭС РД 009

### Офис по работе с юридическими лицами:

105318, г.Москва, ул.Щербаковская д.3, офис 1107, 1118, ДЦ «Щербаковский»

Телефон: +7 495 668-12-70 (многоканальный)

Факс: +7 495 668-12-70 (доб.304)

E-mail: [info@moschip.ru](mailto:info@moschip.ru)

Skype отдела продаж:

moschip.ru

moschip.ru\_4

moschip.ru\_6

moschip.ru\_9