

### FEATURES

- ESD Protection over  $\pm 10\text{kV}$   
( $\pm 15\text{kV}$  IEC-1000-4-2 for LT1133A, LT1137A and LT1141A)
- Uses Small Capacitors:  $0.1\mu\text{F}$ ,  $0.2\mu\text{F}$
- $1\mu\text{A}$  Supply Current in SHUTDOWN
- 120kbaud Operation for  $R_L = 3\text{k}$ ,  $C_L = 2500\text{pF}$
- 250kbaud Operation for  $R_L = 3\text{k}$ ,  $C_L = 1000\text{pF}$
- CMOS Comparable Low Power
- Easy PC Layout: Flowthrough Architecture
- Rugged Bipolar Design: Absolutely No Latchup
- Outputs Assume a High Impedance State When Off or Powered Down
- Improved Protection: RS232 I/O Lines Can Be Forced to  $\pm 30\text{V}$  Without Damage
- Output Overvoltage Does Not Force Current Back into Supplies
- Available in SO and SSOP Packages

### DESCRIPTION

The LT<sup>®</sup>1130A/LT1140A series of RS232 drivers/receivers features special bipolar construction techniques which protect the drivers and receivers beyond the fault conditions stipulated for RS232. Driver outputs and receiver inputs can be shorted to  $\pm 30\text{V}$  without damaging the device or the power supply generator. In addition, the RS232 I/O pins are resilient to multiple  $\pm 10\text{kV}$  ESD strikes. An advanced driver output stage operates up to 250kbaud while driving heavy capacitive loads. Supply current is typically 12mA, competitive with CMOS devices.

Several members of the series include flexible operating mode controls. The DRIVER DISABLE pin disables the drivers and the charge pump, the ON/OFF pin shuts down all circuitry. While shut down, the drivers and receivers assume high impedance output states.

LT, LTC and LT are registered trademarks of Linear Technology Corporation.

### TYPICAL APPLICATION

Basic Operation



Output Waveforms



- LT1130A 5-Driver/5-Receiver RS232 Transceiver
- LT1131A 5-Driver/4-Receiver RS232 Transceiver w/Shutdown
- LT1132A 5-Driver/3-Receiver RS232 Transceiver
- LT1133A 3-Driver/5-Receiver RS232 Transceiver
- LT1134A 4-Driver/4-Receiver RS232 Transceiver
- LT1135A 5-Driver/3-Receiver RS232 Transceiver w/o Charge Pump

- LT1136A 4-Driver/5-Receiver RS232 Transceiver w/Shutdown
- LT1137A 3-Driver/5-Receiver RS232 Transceiver w/Shutdown
- LT1138A 5-Driver/3-Receiver RS232 Transceiver w/Shutdown
- LT1139A 4-Driver/4-Receiver RS232 Transceiver w/Shutdown
- LT1140A 5-Driver/3-Receiver RS232 Transceiver w/o Charge Pump
- LT1141A 3-Driver/5-Receiver RS232 Transceiver w/o Charge Pump

# LT1130A/LT1140A Series

## ABSOLUTE MAXIMUM RATINGS (Note 1)

Supply Voltage ( $V_{CC}$ ) .....	6V	Short-Circuit Duration	
$V^+$ .....	13.2V	$V^+$ .....	30 sec
$V^-$ (Note 7) .....	-13.2V	$V^-$ .....	30 sec
Input Voltage		Driver Output .....	Indefinite
Driver .....	$V^-$ to $V^+$	Receiver Output .....	Indefinite
Receiver .....	-30V to 30V	Operating Temperature Range	
On/Off Pin .....	-0.3V to 12V	LT113XAC/LT114XAC .....	0°C to 70°C
Driver Disable Pin .....	-0.3V to ( $V_{CC} + 0.3V$ )	LT113XAI/LT114XAI .....	-40° to 85°C
Output Voltage		Storage Temperature Range .....	-65°C to 150°C
Driver .....	-30V to 30V	Lead Temperature (Soldering, 10 sec) .....	300°C
Receiver .....	-0.3V to ( $V_{CC} + 0.3V$ )		

## PRODUCT SELECTION TABLE

Part Number	Power Supply Voltages*	Shutdown	Driver Disable	Drivers	Receivers	External Components
LT1130A	5	No	No	5	5	4 Capacitors
LT1131A	5	Yes	Yes	5	4	4 Capacitors
LT1132A	5	No	No	5	3	4 Capacitors
LT1133A**	5	No	No	3	5	4 Capacitors
LT1134A	5	No	No	4	4	4 Capacitors
LT1135A	5, 12, -12	No	No	5	3	None
LT1136A	5	Yes	Yes	4	5	4 Capacitors
LT1137A**	5	Yes	Yes	3	5	4 Capacitors
LT1138A	5	Yes	Yes	5	3	4 Capacitors
LT1139A	5, 12	Yes	No	4	4	2 Capacitors
LT1140A	5, 12, -12	Yes	Yes	5	3	None
LT1141A**	5, 12, -12	Yes	Yes	3	5	None

\*The LT1130A, LT1131A, LT1132A, LT1134A, LT1136A, LT1137A and LT1138A can operate with 5V and 12V supplies and two external capacitors.

\*\*Meets  $\pm 15kV$  ESD air gap discharge and  $\pm 8kV$  contact methods per IEC-1000-4-2.

## PACKAGE/ORDER INFORMATION

5-DRIVER/5-RECEIVER	ORDER PART NUMBER	5-DRIVER/4-RECEIVER WITH SHUTDOWN	ORDER PART NUMBER
<p>NW PACKAGE: 28-LEAD PDIP SW PACKAGE: 28-LEAD PLASTIC SO WIDE</p> <p><math>T_{JMAX} = 150^{\circ}C, \theta_{JA} = 56^{\circ}C/W</math> (NW) <math>T_{JMAX} = 150^{\circ}C, \theta_{JA} = 68^{\circ}C/W</math> (SW)</p>	<p>LT1130ACNW LT1130ACSW LT1130AISW</p>	<p>NW PACKAGE: 28-LEAD PDIP SW PACKAGE: 28-LEAD PLASTIC SO WIDE</p> <p><math>T_{JMAX} = 150^{\circ}C, \theta_{JA} = 56^{\circ}C/W</math> (NW) <math>T_{JMAX} = 150^{\circ}C, \theta_{JA} = 68^{\circ}C/W</math> (SW)</p>	<p>LT1131ACNW LT1131ACSW</p>

**PACKAGE/ORDER INFORMATION**

<p><b>5-DRIVER/3-RECEIVER</b></p> <p>TOP VIEW</p> <p>N PACKAGE SW PACKAGE 24-LEAD PDIP 24-LEAD PLASTIC SO WIDE</p> <p><math>T_{JMAX} = 150^{\circ}C, \theta_{JA} = 58^{\circ}C/W (N)</math> <math>T_{JMAX} = 150^{\circ}C, \theta_{JA} = 80^{\circ}C/W (SW)</math></p>	<p><b>ORDER PART NUMBER</b></p> <p>LT1132ACN LT1132ACSW LT1132AISW</p>	<p><b>3-DRIVER/5-RECEIVER</b></p> <p>TOP VIEW</p> <p>N PACKAGE SW PACKAGE 24-LEAD PDIP 24-LEAD PLASTIC SO WIDE</p> <p><math>T_{JMAX} = 150^{\circ}C, \theta_{JA} = 58^{\circ}C/W (N)</math> <math>T_{JMAX} = 150^{\circ}C, \theta_{JA} = 80^{\circ}C/W (SW)</math></p>	<p><b>ORDER PART NUMBER</b></p> <p>LT1133ACN LT1133ACSW LT1133AISW</p>
<p><b>4-DRIVER/4-RECEIVER</b></p> <p>TOP VIEW</p> <p>N PACKAGE SW PACKAGE 24-LEAD PDIP 24-LEAD PLASTIC SO WIDE</p> <p><math>T_{JMAX} = 150^{\circ}C, \theta_{JA} = 58^{\circ}C/W (N)</math> <math>T_{JMAX} = 150^{\circ}C, \theta_{JA} = 80^{\circ}C/W (SW)</math></p>	<p><b>ORDER PART NUMBER</b></p> <p>LT1134ACN LT1134ACSW LT1134AIN LT1134AISW</p>	<p><b>5-DRIVER/3-RECEIVER WITHOUT CHARGE PUMP</b></p> <p>TOP VIEW</p> <p>N PACKAGE SW PACKAGE 20-LEAD PDIP 20-LEAD PLASTIC SO WIDE</p> <p><math>T_{JMAX} = 150^{\circ}C, \theta_{JA} = 79^{\circ}C/W (N)</math> <math>T_{JMAX} = 150^{\circ}C, \theta_{JA} = 85^{\circ}C/W (SW)</math></p>	<p><b>ORDER PART NUMBER</b></p> <p>LT1135ACN LT1135ACSW</p>
<p><b>4-DRIVER/5-RECEIVER WITH SHUTDOWN</b></p> <p>TOP VIEW</p> <p>NW PACKAGE SW PACKAGE 28-LEAD PDIP 28-LEAD PLASTIC SO WIDE</p> <p><math>T_{JMAX} = 150^{\circ}C, \theta_{JA} = 56^{\circ}C/W (NW)</math> <math>T_{JMAX} = 150^{\circ}C, \theta_{JA} = 68^{\circ}C/W (SW)</math></p>	<p><b>ORDER PART NUMBER</b></p> <p>LT1136ACNW LT1136ACSW</p>	<p><b>3-DRIVER/5-RECEIVER WITH SHUTDOWN</b></p> <p>TOP VIEW</p> <p>G PACKAGE NW PACKAGE SW PACKAGE 28-LEAD PLASTIC SSOP 28-LEAD PDIP 28-LEAD PLASTIC SO WIDE</p> <p><math>T_{JMAX} = 150^{\circ}C, \theta_{JA} = 96^{\circ}C/W (G)</math> <math>T_{JMAX} = 150^{\circ}C, \theta_{JA} = 56^{\circ}C/W (NW)</math> <math>T_{JMAX} = 150^{\circ}C, \theta_{JA} = 68^{\circ}C/W (SW)</math></p>	<p><b>ORDER PART NUMBER</b></p> <p>LT1137ACG LT1137ACNW LT1137ACSW LT1137AIG LT1137AINW LT1137AISW</p>

# LT1130A/LT1140A Series

## PACKAGE/ORDER INFORMATION

<p><b>5-DRIVER/3-RECEIVER WITH SHUTDOWN</b></p> <p>TOP VIEW</p> <p>G PACKAGE 28-LEAD PLASTIC SSOP NW PACKAGE 28-LEAD PDIP SW PACKAGE 28-LEAD PLASTIC SO WIDE</p> <p><math>T_{JMAX} = 150^{\circ}\text{C}</math>, <math>\theta_{JA} = 96^{\circ}\text{C/W}</math> (G) <math>T_{JMAX} = 150^{\circ}\text{C}</math>, <math>\theta_{JA} = 56^{\circ}\text{C/W}</math> (NW) <math>T_{JMAX} = 150^{\circ}\text{C}</math>, <math>\theta_{JA} = 68^{\circ}\text{C/W}</math> (SW)</p>	<p>ORDER PART NUMBER</p> <p>LT1138ACG LT1138ACNW LT1138ACSW LT1138AIG</p>	<p><b>4-DRIVER/4-RECEIVER WITH SHUTDOWN WITH 12V AND 5V SUPPLIES</b></p> <p>TOP VIEW</p> <p>N PACKAGE 24-LEAD PDIP SW PACKAGE 24-LEAD PLASTIC SO WIDE</p> <p><math>T_{JMAX} = 150^{\circ}\text{C}</math>, <math>\theta_{JA} = 58^{\circ}\text{C/W}</math> (N) <math>T_{JMAX} = 150^{\circ}\text{C}</math>, <math>\theta_{JA} = 80^{\circ}\text{C/W}</math> (SW)</p>	<p>ORDER PART NUMBER</p> <p>LT1139ACN LT1139ACSW</p>
<p><b>5-DRIVER/3-RECEIVER WITH SHUTDOWN WITHOUT CHARGE PUMP</b></p> <p>TOP VIEW</p> <p>N PACKAGE 24-LEAD PDIP SW PACKAGE 24-LEAD PLASTIC SO WIDE</p> <p><math>T_{JMAX} = 150^{\circ}\text{C}</math>, <math>\theta_{JA} = 58^{\circ}\text{C/W}</math> (N) <math>T_{JMAX} = 150^{\circ}\text{C}</math>, <math>\theta_{JA} = 80^{\circ}\text{C/W}</math> (SW)</p>	<p>ORDER PART NUMBER</p> <p>LT1140ACN LT1140ACSW</p>	<p><b>3-DRIVER/5-RECEIVER WITH SHUTDOWN WITHOUT CHARGE PUMP</b></p> <p>TOP VIEW</p> <p>N PACKAGE 24-LEAD PDIP SW PACKAGE 24-LEAD PLASTIC SO WIDE</p> <p><math>T_{JMAX} = 150^{\circ}\text{C}</math>, <math>\theta_{JA} = 58^{\circ}\text{C/W}</math> (N) <math>T_{JMAX} = 150^{\circ}\text{C}</math>, <math>\theta_{JA} = 80^{\circ}\text{C/W}</math> (SW)</p>	<p>ORDER PART NUMBER</p> <p>LT1141ACN LT1141ACSW</p>

Consult factory for Industrial and Military grade parts.

## ELECTRICAL CHARACTERISTICS

The ● denotes the specifications which apply over the full operating temperature range, otherwise specifications are at  $T_A = 25^{\circ}\text{C}$ . (Note 2)

PARAMETER	CONDITIONS	MIN	TYP	MAX	UNITS
<b>Power Supply Generator</b>					
$V^+$ Output			8.6		V
$V^-$ Output			-7.8		V
5V $V_{CC}$ Supply Current: LT1130A, LT1131A, LT1132A, LT1133A, LT1134A, LT1136A, LT1138A	(Note 3)	●	15	25	mA
5V $V_{CC}$ Supply Current: LT1135A, LT1140A, LT1141A	(Note 3), $V^+ = 12\text{V}$ , $V^- = -12\text{V}$	●	8	15	mA
5V $V_{CC}$ Supply Current: LT1137A	(Note 3)	●	12	17	mA
5V $V_{CC}$ Supply Current: LT1139A	(Note 3), $V^+ = 12\text{V}$	●	8	15	mA
12V $V^+$ Supply Current: LT1135A, LT1140A, LT1141A	(Note 3), $V^- = -12\text{V}$	●	1	4	mA
12V $V^+$ Supply Current: LT1139A	(Note 3)	●	6	10	mA
-12V $V^-$ Supply Current: LT1135A, LT1140A, LT1141A	(Note 3) $V^+ = 12\text{V}$	●	2	6	mA

## ELECTRICAL CHARACTERISTICS

The ● denotes the specifications which apply over the full operating temperature range, otherwise specifications are at  $T_A = 25^\circ\text{C}$ . (Note 2)

PARAMETER	CONDITIONS		MIN	TYP	MAX	UNITS
Supply Current when OFF ( $V_{CC}$ )	Shutdown (Note 4) Driver Disable	●		1 4	10	$\mu\text{A}$ mA
Supply Rise Time Shutdown to Turn-On	$C_1, C_2, C^+, C^- = 1.0\mu\text{F}$ $C^+, C^- = 0.1\mu\text{F}, C_1, C_2 = 0.2\mu\text{F}$			2.0 0.2		ms ms
ON/OFF Pin Thresholds	Input Low Level (Device Shut Down) Input High Level (Device Enabled)	● ●		1.4 1.4	0.8	V V
ON/OFF Pin Current	$0\text{V} \leq V_{\text{ON/OFF}} \leq 5\text{V}$	●	-15		80	$\mu\text{A}$
DRIVER DISABLE Pin Thresholds	Input Low Level (Drivers Enabled) Input High Level (Drivers Disabled)	● ●		1.4 1.4	0.8	V V
DRIVER DISABLE Pin Current	$0\text{V} \leq V_{\text{DRIVER DISABLE}} \leq 5\text{V}$	●	-10		500	$\mu\text{A}$
Oscillator Frequency				130		kHz
<b>Any Driver</b>						
Output Voltage Swing	Load = 3k to GND Positive Negative	● ●	5	7.3 -6.5	-5	V V
Logic Input Voltage Level	Input Low Level ( $V_{\text{OUT}} = \text{High}$ ) Input High Level ( $V_{\text{OUT}} = \text{Low}$ )	● ●		1.4 1.4	0.8	V V
Logic Input Current	$0.8\text{V} \leq V_{\text{IN}} \leq 2\text{V}$	●		5	20	$\mu\text{A}$
Output Short-Circuit Current	$V_{\text{OUT}} = 0\text{V}$		$\pm 9$	$\pm 17$		mA
Output Leakage Current	Shutdown $V_{\text{OUT}} = \pm 30\text{V}$ (Note 4)	●		10	100	$\mu\text{A}$
Data Rate	$R_L = 3\text{k}, C_L = 2500\text{pF}$ $R_L = 3\text{k}, C_L = 1000\text{pF}$		120 250			kbaud kbaud
Slew Rate	$R_L = 3\text{k}, C_L = 51\text{pF}$ $R_L = 3\text{k}, C_L = 2500\text{pF}$ (Note 8)			15 6	30	V/ $\mu\text{s}$ V/ $\mu\text{s}$
Propagation Delay	Output Transition $t_{\text{HL}}$ High to Low (Note 5) Output Transition $t_{\text{LH}}$ Low to High			0.6 0.5	1.3 1.3	$\mu\text{s}$ $\mu\text{s}$
<b>Any Receiver</b>						
Input Voltage Thresholds	Input Low Threshold ( $V_{\text{OUT}} = \text{High}$ ) Input High Threshold ( $V_{\text{OUT}} = \text{Low}$ )	● ●	0.8	1.3 1.7	2.4	V V
Hysteresis		●	0.1	0.4	1	V
Input Resistance	$-10\text{V} < V_{\text{IN}} < 10\text{V}$		3	5	7	$\text{k}\Omega$
Output Voltage	Output Low, $I_{\text{OUT}} = -1.6\text{mA}$ Output High, $I_{\text{OUT}} = 160\mu\text{A}$ ( $V_{\text{CC}} = 5\text{V}$ )	● ●	3.5	0.2 4.2	0.4	V V
Output Leakage Current	Shutdown (Note 4) $0 \leq V_{\text{OUT}} \leq V_{\text{CC}}$	●		1	10	$\mu\text{A}$
Output Short-Circuit Current	Sinking Current, $V_{\text{OUT}} = V_{\text{CC}}$ Sourcing Current, $V_{\text{OUT}} = 0\text{V}$		10	-20 20	-10	mA mA
Propagation Delay	Output Transition $t_{\text{HL}}$ High to Low (Note 6) Output Transition $t_{\text{LH}}$ Low to High			250 350	600 600	ns ns

**Note 1:** Absolute Maximum Ratings are those values beyond which the life of the device may be impaired.

**Note 2:** Testing done at  $V_{\text{CC}} = 5\text{V}$  and  $V_{\text{ON/OFF}} = 3\text{V}$ .

**Note 3:** Supply current is measured with driver and receiver outputs unloaded and the driver inputs tied high.

**Note 4:** Supply current and driver leakage current measurements in shutdown are performed with  $V_{\text{ON/OFF}} = 0.1\text{V}$ . Supply current measurements using DRIVER DISABLE are performed with  $V_{\text{DRIVER DISABLE}} = 3\text{V}$ . For LT1135, LT1139, LT1140 and LT1141 with 12V supplies,  $V_{\text{OUT}}$  leakage is  $200\mu\text{A}$  for  $V_{\text{OUT}}$  forced to  $\pm 25\text{V}$ .

**Note 5:** For driver delay measurements,  $R_L = 3\text{k}$  and  $C_L = 51\text{pF}$ . Trigger points are set between the driver's input logic threshold and the output transition to the zero crossing ( $t_{\text{HL}} = 1.4\text{V}$  to  $0\text{V}$  and  $t_{\text{LH}} = 1.4\text{V}$  to  $0\text{V}$ ).

**Note 6:** For receiver delay measurements,  $C_L = 51\text{pF}$ . Trigger points are set between the receiver's input logic threshold and the output transition to standard TTL/CMOS logic threshold ( $t_{\text{HL}} = 1.3\text{V}$  to  $2.4\text{V}$  and  $t_{\text{LH}} = 1.7\text{V}$  to  $0.8\text{V}$ ).

**Note 7:** For LT1133A/LT1137A, absolute maximum externally applied  $V^- = -6.5\text{V}$ . Internal charge pump will drive this pin to a higher negative voltage.

**Note 8:** For LT1137A,  $4\text{V}/\mu\text{s}$  minimum.

## TYPICAL PERFORMANCE CHARACTERISTICS



LT1130A • TPC01



LT1137A • TPC02

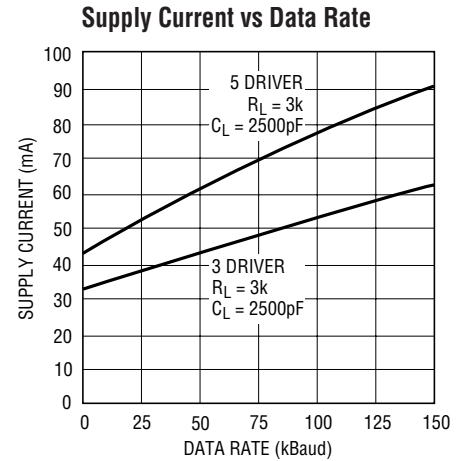

LT1130A • TPC03



LT1137A • TPC04



LT1137A • TPC05

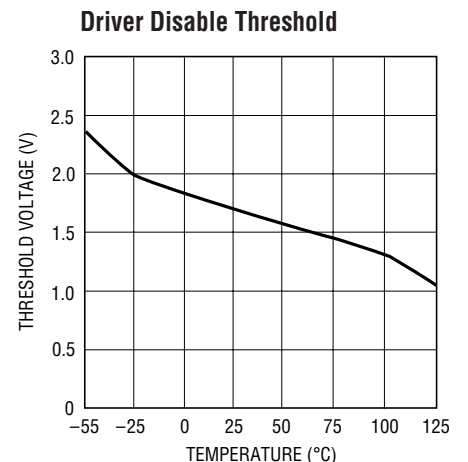

LT1137A • TPC06

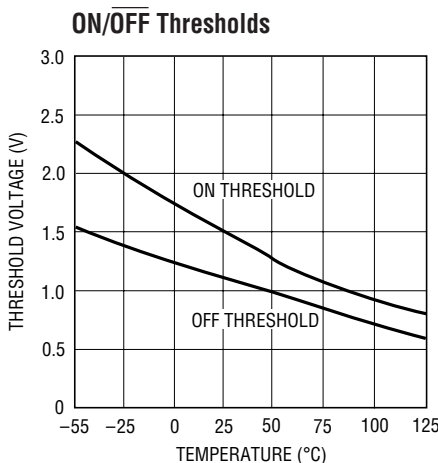

LT1137A • TPC07

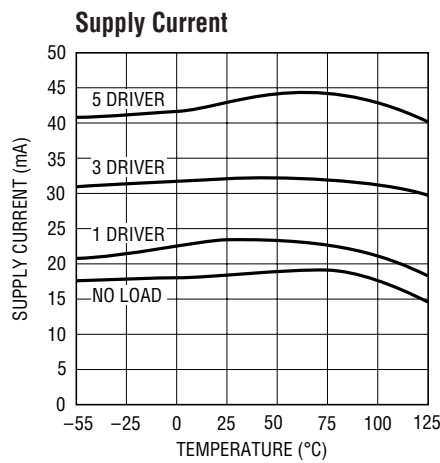

LT1130A • TPC08

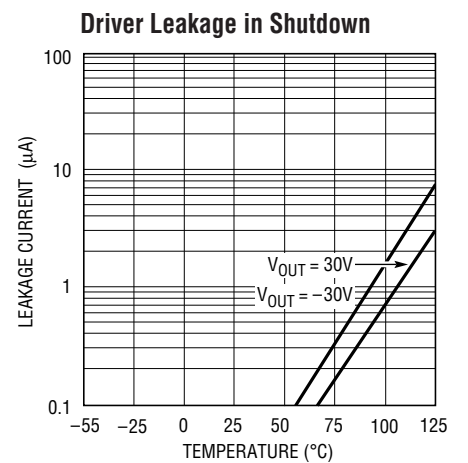

LT1137A • TPC09

## TYPICAL PERFORMANCE CHARACTERISTICS



## PIN FUNCTIONS

**V<sub>CC</sub>**: 5V Input Supply Pin. Supply current drops to zero in the shutdown mode. This pin should be decoupled with a 0.1µF ceramic capacitor close to the package pin. Insufficient supply bypassing can result in low output drive levels and erratic charge pump operation.

**GND**: Ground Pin.

**ON/OFF**: Control the operation mode of the device and is TTL/CMOS compatible. A logic low puts the device in the shutdown mode which reduces input supply current to zero and places all of the drivers and receivers in high impedance state. A logic high fully enables the transceiver.

**DRIVER DISABLE**: This pin provides an alternate control for the charge pump and RS232 drivers. A logic high on this pin shuts down the charge pump and places all drivers

in a high impedance state. Receivers remain active under these conditions. Floating the DRIVER DISABLE pin or driving it to a logic low level fully enables the transceiver. A logic low on the ON/OFF pin supersedes the state of the DRIVER DISABLE pin. Supply current drops to 4mA when in driver disable mode.

**V<sup>+</sup>**: Positive Supply Output (RS232 Drivers).  $V^+ \approx 2V_{CC} - 1.5V$ . This pin requires an external charge storage capacitor  $C \geq 1.0\mu F$ , tied to ground or  $V_{CC}$ . Larger value capacitors may be used to reduce supply ripple. With multiple transceivers, the  $V^+$  and  $V^-$  pins may be paralleled into common capacitors. For large numbers of transceivers, increasing the size of the shared common storage capacitors is recommended to reduce ripple.

# LT1130A/LT1140A Series

## PIN FUNCTIONS

**V<sup>-</sup>**: Negative Supply Output (RS232 Drivers).  $V^- \approx -(2V_{CC} - 2.5V)$ . This pin requires an external charge storage capacitor  $C \geq 0.1\mu F$ .  $V^-$  is short-circuit proof for 30 seconds.

**C1<sup>+</sup>, C1<sup>-</sup>, C2<sup>+</sup>, C2<sup>-</sup>**: Commutating Capacitor Inputs. These pins require two external capacitors  $C \geq 0.2\mu F$ : one from C1<sup>+</sup> to C1<sup>-</sup>, and another from C2<sup>+</sup> to C2<sup>-</sup>. To maintain charge pump efficiency, the capacitor's effective series resistance should be less than  $2\Omega$ . For  $C \geq 1\mu F$ , low ESR tantalum capacitors work well in this application, although small value ceramic capacitors may be used with a minimal reduction in charge pump compliance. In applications where larger positive voltages are available, such as 12V, C1 may be omitted and the positive voltage may be connected directly to the C1<sup>+</sup> pin. In this mode of operation, the V<sup>+</sup> pin should be decoupled with a  $0.1\mu F$  ceramic capacitor.

**DRIVER IN**: RS232 Driver Input Pins. These inputs are TTL/CMOS compatible. Inputs should not be allowed to float. Tie unused inputs to  $V_{CC}$ .

**DRIVER OUT**: Driver Outputs at RS232 Voltage Levels. Driver output swing meets RS232 levels for loads up to 3k.

Slew rates are controlled for lightly loaded lines. Output current capability is sufficient for load conditions up to 2500pF. Outputs are in a high impedance state when in shutdown mode,  $V_{CC} = 0V$ , or when the DRIVER DISABLE pin is active. Outputs are fully short-circuit protected from  $V^- + 30V$  to  $V^+ - 30V$ . Applying higher voltages will not damage the device if the overdrive is moderately current limited. Short circuits on one output can load the power supply generator and may disrupt the signal levels of the other outputs. The driver outputs are protected against ESD to  $\pm 10kV$  for human body model discharges.

**RX IN**: Receiver Inputs. These pins accept RS232 level signals ( $\pm 30V$ ) into a protected 5k terminating resistor. The receiver inputs are protected against ESD to  $\pm 10kV$  for human body model discharges. Each receiver provides 0.4V of hysteresis for noise immunity. Open receiver inputs assume a logic low state.

**RX OUT**: Receiver Outputs with TTL/CMOS Voltage Levels. Outputs are in a high impedance state when in shutdown mode to allow data line sharing. Outputs are fully short-circuit protected to ground or  $V_{CC}$  with the power on, off, or in shutdown mode.

## ESD PROTECTION

The RS232 line inputs of the LT1130A/LT1140A series of RS232 Driver/Receivers have on-chip protection from ESD transients up to  $\pm 10kV$ . The protection structures act to divert the static discharge safely to system ground. In order for the ESD protection to function effectively, the power supply and ground pins of the LT1130A/LT1140A must be connected to ground through low impedances. The power supply decoupling capacitors and charge pump storage capacitors provide this low impedance in normal application of the circuit. The only constraint is that low ESR capacitors must be used for bypassing and charge storage. ESD testing must be done with pins  $V_{CC}$ ,  $V^+$ ,  $V^-$  and GND shorted to ground or connected with low ESR capacitors.

The ESD protection on the LT1133A, LT1137A and LT1141A meets  $\pm 15kV$  air gap discharge and  $\pm 8kV$  contact methods per IEC-1000-4-2.

ESD Test Circuit



LT1130A • ESD TC



# TYPICAL APPLICATIONS

Operation Using 5V and 12V Power Supplies



LT1130A • TA03

Typical Mouse Driving Application



LT1130A • TA04

## PACKAGE DESCRIPTION Dimensions in inches (millimeters) unless otherwise noted.

### G Package 28-Lead Plastic SSOP (0.209) (LTC DWG # 05-08-1640)

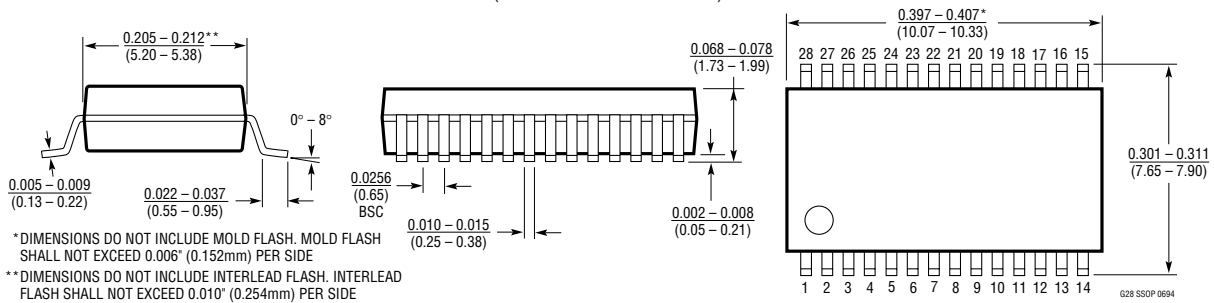

### N Package 20-Lead PDIP (Narrow 0.300) (LTC DWG # 05-08-1510)



### N Package 24-Lead PDIP (Narrow 0.300) (LTC DWG # 05-08-1510)



## PACKAGE DESCRIPTION Dimensions in inches (millimeters) unless otherwise noted.

### NW Package 28-Lead PDIP (Wide 0.600) (LTC DWG # 05-08-1520)



\*THESE DIMENSIONS DO NOT INCLUDE MOLD FLASH OR PROTRUSIONS.  
MOLD FLASH OR PROTRUSIONS SHALL NOT EXCEED 0.010 INCH (0.254mm)

### SW Package 20-Lead Plastic Small Outline (Wide 0.300) (LTC DWG # 05-08-1620)



NOTE:  
1. PIN 1 IDENT, NOTCH ON TOP AND CAVITIES ON THE BOTTOM OF PACKAGES ARE THE MANUFACTURING OPTIONS.  
THE PART MAY BE SUPPLIED WITH OR WITHOUT ANY OF THE OPTIONS  
\*DIMENSION DOES NOT INCLUDE MOLD FLASH. MOLD FLASH SHALL NOT EXCEED 0.006" (0.152mm) PER SIDE  
\*\*DIMENSION DOES NOT INCLUDE INTERLEAD FLASH. INTERLEAD FLASH SHALL NOT EXCEED 0.010" (0.254mm) PER SIDE

### SW Package 24-Lead Plastic Small Outline (Wide 0.300) (LTC DWG # 05-08-1620)



NOTE:  
1. PIN 1 IDENT, NOTCH ON TOP AND CAVITIES ON THE BOTTOM OF PACKAGES ARE THE MANUFACTURING OPTIONS.  
THE PART MAY BE SUPPLIED WITH OR WITHOUT ANY OF THE OPTIONS  
\*DIMENSION DOES NOT INCLUDE MOLD FLASH. MOLD FLASH SHALL NOT EXCEED 0.006" (0.152mm) PER SIDE  
\*\*DIMENSION DOES NOT INCLUDE INTERLEAD FLASH. INTERLEAD FLASH SHALL NOT EXCEED 0.010" (0.254mm) PER SIDE

# LT1130A/LT1140A Series

## PACKAGE DESCRIPTION Dimensions in inches (millimeters) unless otherwise noted.

### SW Package 28-Lead Plastic Small Outline (Wide 0.300) (LTC DWG # 05-08-1620)

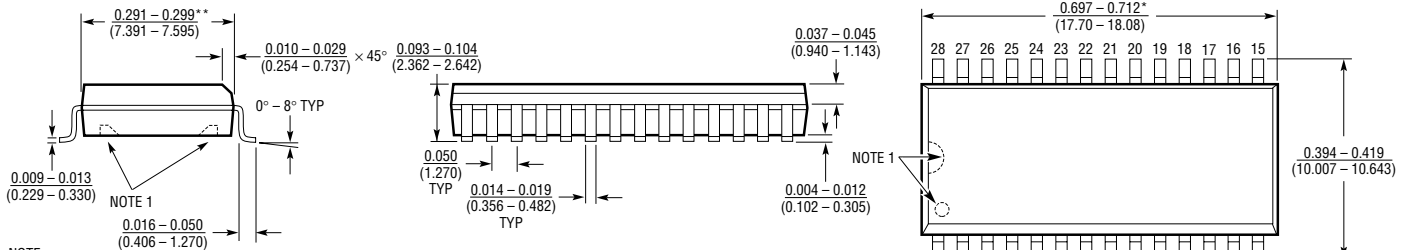

NOTE:  
1. PIN 1 IDENT, NOTCH ON TOP AND CAVITIES ON THE BOTTOM OF PACKAGES ARE THE MANUFACTURING OPTIONS. THE PART MAY BE SUPPLIED WITH OR WITHOUT ANY OF THE OPTIONS  
\*DIMENSION DOES NOT INCLUDE MOLD FLASH. MOLD FLASH SHALL NOT EXCEED 0.006" (0.152mm) PER SIDE  
\*\*DIMENSION DOES NOT INCLUDE INTERLEAD FLASH. INTERLEAD FLASH SHALL NOT EXCEED 0.010" (0.254mm) PER SIDE

## TYPICAL APPLICATION

### Sharing Power Supply Generator with a Second Transceiver

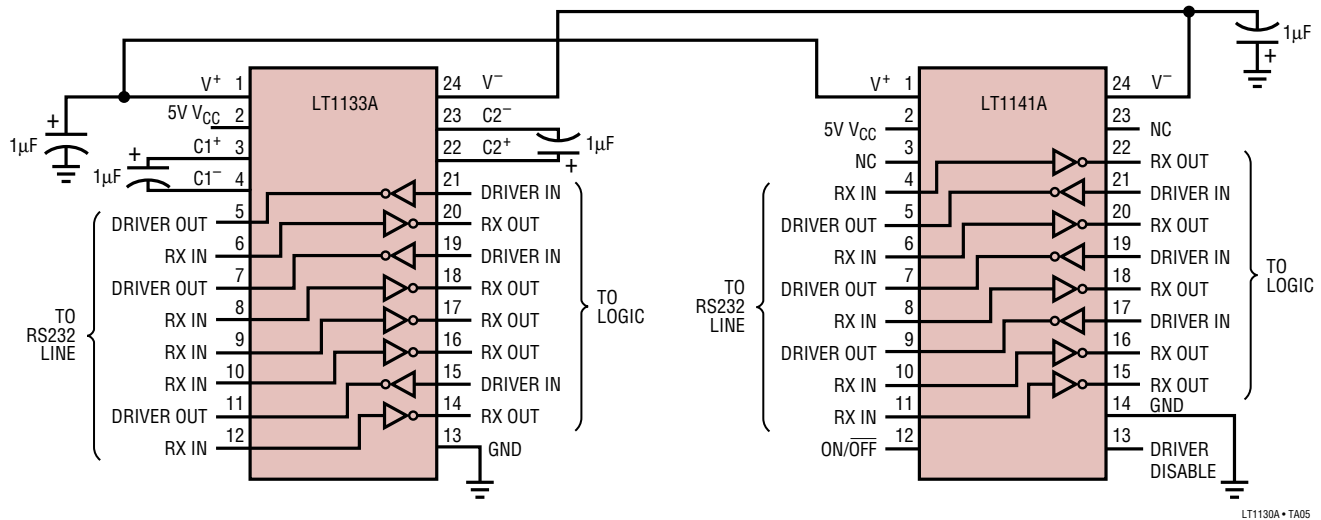

LT1130A • TA05

## RELATED PARTS

PART NUMBER	DESCRIPTION	COMMENTS
LT1180A/LT1181A	2-Driver/2-Receiver RS232 Transceivers	Single 5V Supply with 0.1µF Capacitors
LT1237	3-Driver/5-Receiver RS232 Transceiver	Lower Power Upgrade for LT1137A
LTC1327	3-Driver/5-Receiver RS562 Transceiver	3.3V Operation
LTC1337	3-Driver/5-Receiver RS232 Transceiver	Ultralow Power for DTE Applications
LTC1338	5-Driver/3-Receiver RS232 Transceiver	Ultralow Power for DCE Applications
LTC1348	3-Driver/5-Receiver RS232 Transceiver	3.3V to 5V Operation

## Данный компонент на территории Российской Федерации

### Вы можете приобрести в компании MosChip.

Для оперативного оформления запроса Вам необходимо перейти по данной ссылке:

<http://moschip.ru/get-element>

Вы можете разместить у нас заказ для любого Вашего проекта, будь то серийное производство или разработка единичного прибора.

В нашем ассортименте представлены ведущие мировые производители активных и пассивных электронных компонентов.

Нашей специализацией является поставка электронной компонентной базы двойного назначения, продукции таких производителей как XILINX, Intel (ex.ALTERA), Vicor, Microchip, Texas Instruments, Analog Devices, Mini-Circuits, Amphenol, Glenair.

Сотрудничество с глобальными дистрибьюторами электронных компонентов, предоставляет возможность заказывать и получать с международных складов практически любой перечень компонентов в оптимальные для Вас сроки.

На всех этапах разработки и производства наши партнеры могут получить квалифицированную поддержку опытных инженеров.

Система менеджмента качества компании отвечает требованиям в соответствии с ГОСТ Р ИСО 9001, ГОСТ РВ 0015-002 и ЭС РД 009

### Офис по работе с юридическими лицами:

105318, г.Москва, ул.Щербаковская д.3, офис 1107, 1118, ДЦ «Щербаковский»

Телефон: +7 495 668-12-70 (многоканальный)

Факс: +7 495 668-12-70 (доб.304)

E-mail: [info@moschip.ru](mailto:info@moschip.ru)

Skype отдела продаж:

moschip.ru

moschip.ru\_4

moschip.ru\_6

moschip.ru\_9