

16mm Rotary Type, With Switch Series

Application

- ✓ Audio, Home appliance, Musical instruments, Industrial control

Feature

- ✓ Suitable for various applications



■ Specification

Total Rotational Angle	300±5°
Maximum Operating Voltage	B taper: 200V A.C ; Other taper: 150V A.C
Insulation Resistance	100MΩ at DC 500V
Dielectric Strength	A.C 500V for 1 minute
Rotational Torque	20-200 gf.cm
Click Torque	N/A
Rotational Stop Strength of the Shaft	6 kgf.cm min
Push/Pull Strength of the Shaft	6 kgf.cm for 60 sec
Rotation Life	15,000 cycles
Switch Working Angle/ Stroke	RV16BF&RV16B01F: 4mm; Others: 50±10°
Switch Working Torque/ Force	RV16BF&RV16B01F: 800 gf.cm max; Others: 50-450 gf.cm
Switch Life	10,000 cycles

■ How to order

RV16A04F – 20 B6 – 15K – B100K

[Model](#)

Bushing Type

Order Code	Description
B6	M7x0.75, 10mm
Blank	M7x0.75, 6.5 mm

[Metal Shaft Type](#)

Taper and Resistance Value

Order Code	Taper	Resistance Value
A100K	Log/A	100KΩ
B1M	Linear/B	1MΩ
C500K	Rev-log/C	500KΩ

Taper: A, B and C

Resistance Value: 1KΩ to 500KΩ and 1MΩ

*Contact us for other requirements.





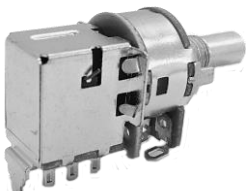
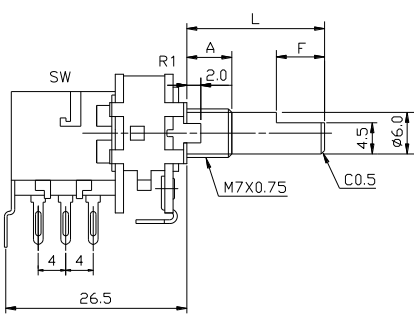
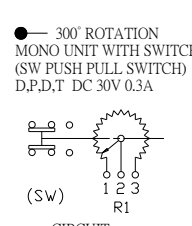
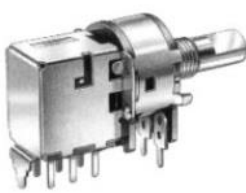
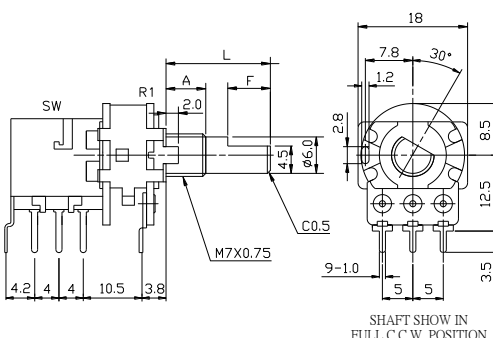

16mm Rotary Type, With Switch Series

Model	Number of Unit	Switch Function	Terminal Type	With Sleeve or Bushing	Rotational Angle
RV16BF-10	Single unit	D.P.D.T. or S.P.D.T Push-Pull SW	Solder lug	Metal bushing	300°±5°
RV16BF-20	Single unit	D.P.D.T. or S.P.D.T Push-Pull SW	Horizontal	Metal bushing	300°±5°
RV16B01F-20	Dual unit	D.P.D.T. or S.P.D.T Push-Pull SW	Horizontal	Metal bushing	300°±5°
RV16A04F-10	Single unit	S.P.S.T. Rotary SW	Solder lug	Metal bushing	300°±5°
RV16A04F-20	Single unit	S.P.S.T. Rotary SW	Horizontal	Metal bushing	300°±5°
RV16A03F-10	Single unit	S.P.S.T. Rotary SW	Solder lug	Metal bushing	300°±5°
RV16A03F-20	Single unit	S.P.S.T. Rotary SW	Horizontal	Metal bushing	300°±5°

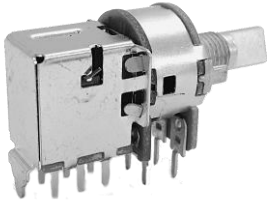
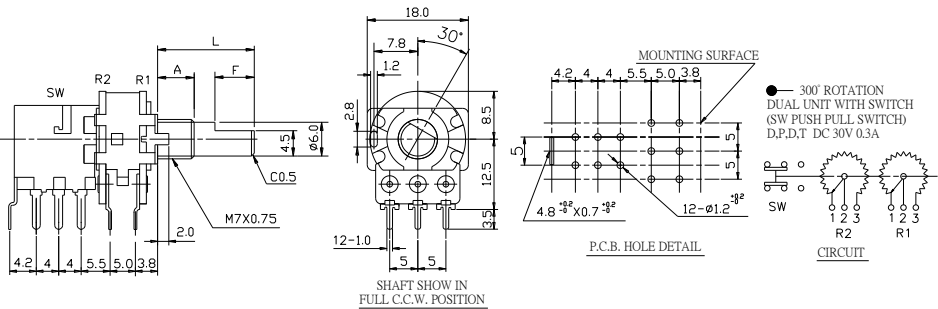
Order Code	Outline Drawing
	 <p>SHAFT SHOW IN FULL C.C.W. POSITION</p>  <p>● 300° ROTATION MONO UNIT WITH SWITCH (SW PUSH PULL SWITCH) D.P.D.T DC 30V 0.3A</p> <p>(Sw) 1 2 3 R1</p> <p>CIRCUIT</p>
	 <p>SHAFT SHOW IN FULL C.C.W. POSITION</p> <p>MOUNTING SURFACE</p> <p>● 300° ROTATION MONO UNIT WITH SWITCH (SW PUSH PULL SWITCH) D.P.D.T DC 30V 0.3A</p> <p>(Sw) 1 2 3 R1</p> <p>CIRCUIT</p> <p>P.C.B. HOLE DETAIL</p>

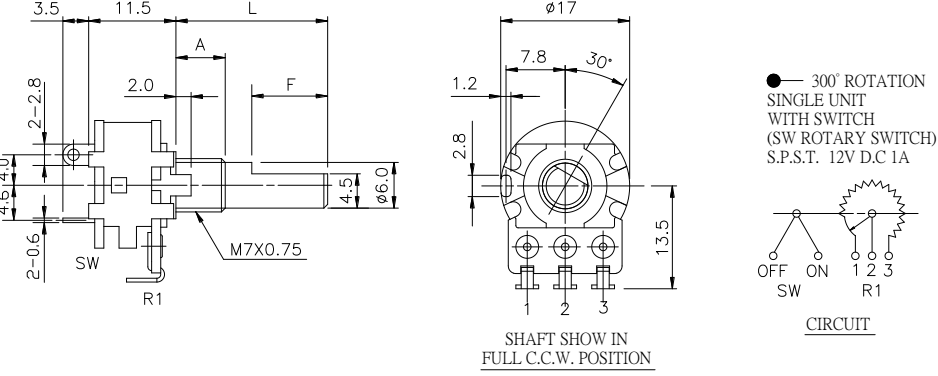
[Back to top](#)

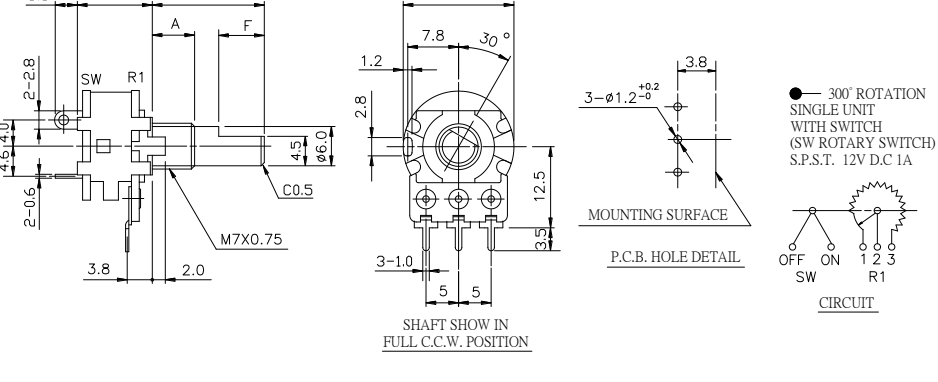
16mm Rotary Type, With Switch Series

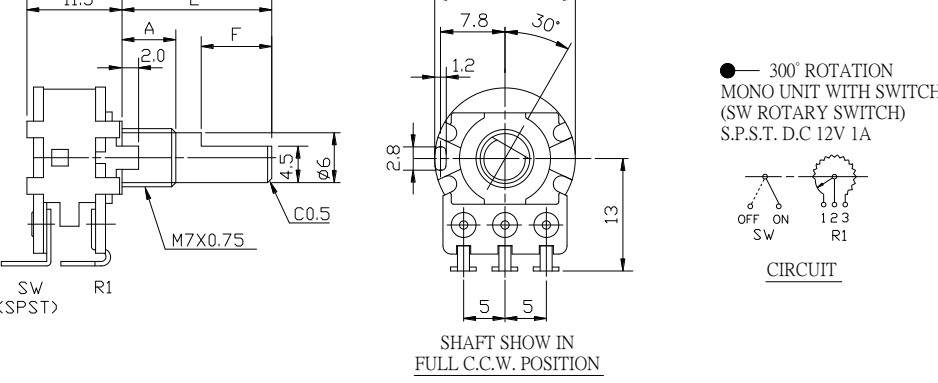
Order Code	Outline Drawing
<p>RV16B01F-20</p> 	 <p>SHAFT SHOW IN FULL C.C.W. POSITION</p> <p>300° ROTATION DUAL UNIT WITH SWITCH (SW PUSH PULL SWITCH) D.P.D.T DC 30V 0.3A</p> <p>CIRCUIT</p>
<p>RV16A04F-10</p> 	 <p>SHAFT SHOW IN FULL C.C.W. POSITION</p> <p>300° ROTATION SINGLE UNIT WITH SWITCH (SW ROTARY SWITCH) S.P.S.T. 12V D.C 1A</p> <p>CIRCUIT</p>
<p>RV16A04F-20</p> 	 <p>SHAFT SHOW IN FULL C.C.W. POSITION</p> <p>300° ROTATION SINGLE UNIT WITH SWITCH (SW ROTARY SWITCH) S.P.S.T. 12V D.C 1A</p> <p>CIRCUIT</p>
<p>RV16A03F-10</p> 	 <p>SHAFT SHOW IN FULL C.C.W. POSITION</p> <p>300° ROTATION MONO UNIT WITH SWITCH (SW ROTARY SWITCH) S.P.S.T. D.C 12V 1A</p> <p>CIRCUIT</p>

[Back to top](#)

16mm Rotary Type, With Switch Series

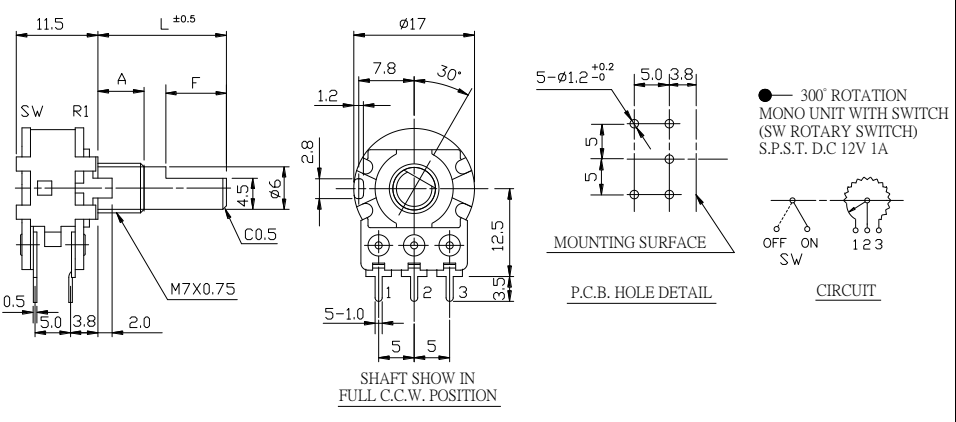
Order Code	Outline Drawing
<p>RV16A03F-20</p> 	 <p>SHAFT SHOW IN FULL C.C.W. POSITION</p> <p>300° ROTATION MONO UNIT WITH SWITCH (SW ROTARY SWITCH) S.P.S.T. D.C 12V 1A</p>

■ Metal Shaft Type

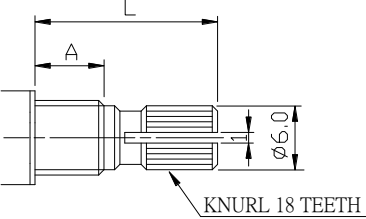
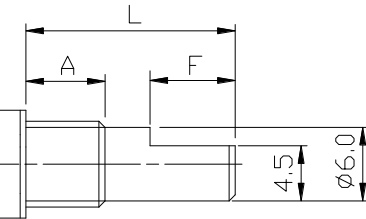
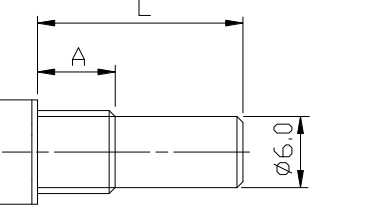
<p>K Type</p>  <p>KNURL 18 TEETH</p>	<p>A : 6.5mm</p> <table border="1" data-bbox="911 925 1158 1122"> <thead> <tr> <th>Order Code</th> <th>L</th> </tr> </thead> <tbody> <tr> <td>15K</td> <td>15</td> </tr> <tr> <td>20K</td> <td>20</td> </tr> <tr> <td>25K</td> <td>25</td> </tr> </tbody> </table>	Order Code	L	15K	15	20K	20	25K	25
Order Code	L								
15K	15								
20K	20								
25K	25								
<p>F Type</p> 	<p>A : 6.5mm</p> <table border="1" data-bbox="911 1281 1158 1478"> <thead> <tr> <th>Order Code</th> <th>L</th> </tr> </thead> <tbody> <tr> <td>15F</td> <td>15</td> </tr> <tr> <td>20F</td> <td>20</td> </tr> <tr> <td>25F</td> <td>25</td> </tr> </tbody> </table>	Order Code	L	15F	15	20F	20	25F	25
Order Code	L								
15F	15								
20F	20								
25F	25								
<p>R Type</p> 	<p>A : 6.5mm</p> <table border="1" data-bbox="911 1637 1158 1834"> <thead> <tr> <th>Order Code</th> <th>L</th> </tr> </thead> <tbody> <tr> <td>15R</td> <td>15</td> </tr> <tr> <td>20R</td> <td>20</td> </tr> <tr> <td>25R</td> <td>25</td> </tr> </tbody> </table>	Order Code	L	15R	15	20R	20	25R	25
Order Code	L								
15R	15								
20R	20								
25R	25								

Design and specifications presented here are for the standard parts only. Please kindly contact us for your special requests and ask for the current technical specifications before purchase and/or use.

[Back to top](#)

Mouser Electronics

Authorized Distributor

Click to View Pricing, Inventory, Delivery & Lifecycle Information:

[Alpha \(Taiwan\):](#)

[RV16A03F-10-15R1-B1M-0030](#) [RV16A03F-10-15R1-B100K-0030](#) [RV16A03F-10-15R1-B500K-0030](#) [RV16A03F-10-15R1-B1K-0030](#) [RV16A03F-10-15R1-B50K-0030](#) [RV16A03F-10-15R1-B5K-0030](#) [RV16A03F-10-15R1-B10K-0030](#)

Данный компонент на территории Российской Федерации

Вы можете приобрести в компании MosChip.

Для оперативного оформления запроса Вам необходимо перейти по данной ссылке:

<http://moschip.ru/get-element>

Вы можете разместить у нас заказ для любого Вашего проекта, будь то серийное производство или разработка единичного прибора.

В нашем ассортименте представлены ведущие мировые производители активных и пассивных электронных компонентов.

Нашей специализацией является поставка электронной компонентной базы двойного назначения, продукции таких производителей как XILINX, Intel (ex.ALTERA), Vicor, Microchip, Texas Instruments, Analog Devices, Mini-Circuits, Amphenol, Glenair.

Сотрудничество с глобальными дистрибьюторами электронных компонентов, предоставляет возможность заказывать и получать с международных складов практически любой перечень компонентов в оптимальные для Вас сроки.

На всех этапах разработки и производства наши партнеры могут получить квалифицированную поддержку опытных инженеров.

Система менеджмента качества компании отвечает требованиям в соответствии с ГОСТ Р ИСО 9001, ГОСТ РВ 0015-002 и ЭС РД 009

Офис по работе с юридическими лицами:

105318, г.Москва, ул.Щербаковская д.3, офис 1107, 1118, ДЦ «Щербаковский»

Телефон: +7 495 668-12-70 (многоканальный)

Факс: +7 495 668-12-70 (доб.304)

E-mail: info@moschip.ru

Skype отдела продаж:

moschip.ru

moschip.ru_4

moschip.ru_6

moschip.ru_9