

## ADA4062-2/ADA4062-4

### FEATURES

- Low input bias current: 50 pA maximum
- Offset voltage
  - 1.5 mV maximum for B grade (ADA4062-2 SOIC package)
  - 2.5 mV maximum for A grade
- Offset voltage drift: 5  $\mu\text{V}/^\circ\text{C}$  typical
- Slew rate: 3.3 V/ $\mu\text{s}$  typical
- CMRR: 90 dB typical
- Low supply current: 165  $\mu\text{A}$  typical
- High input impedance
- Unity-gain stable
- $\pm 5\text{ V}$  to  $\pm 15\text{ V}$  dual-supply operation
- Packaging
  - 8-lead SOIC, 8-lead MSOP, 10-lead LFCSP, 14-lead TSSOP, and 16-lead LFCSP packages

### APPLICATIONS

- Power controls and monitoring
- Active filters
- Industrial/process controls
- Body probe electronics
- Data acquisition
- Integrators
- Input buffering

### GENERAL DESCRIPTION

The ADA4062-2 and ADA4062-4 are dual and quad JFET-input amplifiers with industry-leading performance. They offer lower power, offset voltage, drift, and ultralow bias current. The ADA4062-2 B grade (SOIC package) features a typical low offset voltage of 0.5 mV, an offset drift of 5  $\mu\text{V}/^\circ\text{C}$ , and a bias current of 2 pA.

The ADA4062 family is ideal for various applications, including process controls, industrial and instrumentation equipment, active filtering, data conversion, buffering, and power control and monitoring. With a low supply current of 165  $\mu\text{A}$  per amplifier, they are well suited for lower power applications.

The ADA4062 family is also specified for the extended industrial temperature range of  $-40^\circ\text{C}$  to  $+125^\circ\text{C}$ . The ADA4062-2 is available in lead-free, 8-lead SOIC, 8-lead MSOP, and 10-lead LFCSP (1.6 mm  $\times$  1.3 mm  $\times$  0.55 mm) packages, while the ADA4062-4 is available in lead-free, 14-lead TSSOP and 16-lead LFCSP packages.

### PIN CONFIGURATIONS



Figure 1. 8-Lead Narrow-Body SOIC and 8-Lead MSOP



Figure 2. 10-Lead LFCSP



Figure 3. 14-Lead TSSOP



#### NOTES

1. NC = NO CONNECT.
2. IT IS RECOMMENDED TO CONNECT THE EXPOSED PAD TO V-.

Figure 4. 16-Lead LFCSP

Table 1. Low Power Op Amps

	Precision CMOS	Precision High Bandwidth	High Bandwidth
Single	AD8663	AD8641	
Dual	AD8667	AD8642	AD8682
Quad	AD8669	AD8643	AD8684

#### Rev. B

Information furnished by Analog Devices is believed to be accurate and reliable. However, no responsibility is assumed by Analog Devices for its use, nor for any infringements of patents or other rights of third parties that may result from its use. Specifications subject to change without notice. No license is granted by implication or otherwise under any patent or patent rights of Analog Devices. Trademarks and registered trademarks are the property of their respective owners.

## TABLE OF CONTENTS

Features .....	1
Applications.....	1
General Description .....	1
Pin Configurations .....	1
Revision History .....	2
Specifications.....	3
Electrical Characteristics .....	3
Absolute Maximum Ratings.....	5
Thermal Resistance .....	5
Power Sequencing .....	5

## REVISION HISTORY

### 2/10—Rev. A to Rev. B

Added 16-Lead LFCSP Package.....	Universal
Changes to Features Section, General Description Section, and Table 1 .....	1
Changes to Offset Voltage Drift Parameter, Table 2 .....	3
Changes to Table 4.....	5
Changes to Typical Performance Characteristics Layout.....	6
Added Figure 6 and Figure 9; Renumbered Sequentially .....	6
Changes to Figure 7, Figure 8, and Figure 10 .....	6
Changes to Figure 25 and Figure 28.....	9
Changes to Figure 37 and Figure 40.....	11
Changes to Figure 41 to Figure 46.....	12
Changes to Figure 47 and Figure 50.....	13
Changes to Figure 53 to Figure 58.....	14
Changes to Notch Filter Section and Micropower Instrumentation Amplifier Section.....	15
Updated Outline Dimensions .....	18
Changes to Ordering Guide .....	20

ESD Caution.....	5
Typical Performance Characteristics .....	6
Applications Information .....	15
Notch Filter .....	15
High-Side Signal Conditioning.....	15
Micropower Instrumentation Amplifier.....	15
Phase Reversal .....	16
Schematic.....	17
Outline Dimensions .....	18
Ordering Guide .....	20

### 7/09—Rev. 0 to Rev. A

Added ADA4062-4.....	Universal
Added 14-Lead TSSOP Package.....	Universal
Added 10-Lead LFCSP Package .....	Universal
Changes to Features Section and Table 1 .....	1
Changes to Table 2.....	3
Changes to Thermal Resistance Section .....	5
Changes to Figure 5, Figure 6, Figure 8, and Figure 9.....	6
Changes to Figure 37 and Figure 40.....	11
Changes to Figure 41 and Figure 44.....	12
Changes to Figure 47, Figure 48, Figure 50, and Figure 51.....	13
Added Figure 49 and Figure 52; Renumbered Sequentially .....	13
Changes to Figure 57 and Figure 59.....	15
Changes to Phase Reversal Section and Figure 61 .....	16
Changes to Figure 63.....	17
Updated Outline Dimensions .....	18
Changes to Ordering Guide .....	19

### 10/08—Revision 0: Initial Version

# SPECIFICATIONS

## ELECTRICAL CHARACTERISTICS

$V_{SY} = \pm 15\text{ V}$ ,  $V_{CM} = 0\text{ V}$ ,  $T_A = 25^\circ\text{C}$ , unless otherwise noted.

Table 2.

Parameter	Symbol	Conditions	Min	Typ	Max	Unit
<b>INPUT CHARACTERISTICS</b>						
Offset Voltage	$V_{OS}$					
B Grade (ADA4062-2, 8-Lead SOIC Only)		$-40^\circ\text{C} \leq T_A \leq +125^\circ\text{C}$		0.5	1.5	mV
A Grade		$-40^\circ\text{C} \leq T_A \leq +125^\circ\text{C}$		0.75	2.5	mV
Offset Voltage Drift	$\Delta V_{OS}/\Delta T$	$-40^\circ\text{C} \leq T_A \leq +125^\circ\text{C}$		5	5	$\mu\text{V}/^\circ\text{C}$
Input Bias Current	$I_B$	$-40^\circ\text{C} \leq T_A \leq +125^\circ\text{C}$		2	50	pA
Input Offset Current	$I_{OS}$	$-40^\circ\text{C} \leq T_A \leq +125^\circ\text{C}$		0.5	5	nA
Input Voltage Range		$-40^\circ\text{C} \leq T_A \leq +125^\circ\text{C}$			2.5	nA
Common-Mode Rejection Ratio	CMRR	$-40^\circ\text{C} \leq T_A \leq +125^\circ\text{C}$	-11.5		+15	V
B Grade (ADA4062-2, 8-Lead SOIC Only)		$V_{CM} = -11.5\text{ V to }+11.5\text{ V}$	80	90		dB
A Grade		$-40^\circ\text{C} \leq T_A \leq +125^\circ\text{C}$	80			dB
		$V_{CM} = -11.5\text{ V to }+11.5\text{ V}$	73	90		dB
		$-40^\circ\text{C} \leq T_A \leq +125^\circ\text{C}$	70			dB
Large-Signal Voltage Gain	$A_{VO}$	$R_L = 10\text{ k}\Omega$ , $V_O = -10\text{ V to }+10\text{ V}$	76	83		dB
		$-40^\circ\text{C} \leq T_A \leq +125^\circ\text{C}$	72			dB
Input Resistance	$R_{IN}$			10		T $\Omega$
Input Capacitance, Differential Mode	$C_{INDM}$			1.5		pF
Input Capacitance, Common Mode	$C_{INCM}$			4.8		pF
<b>OUTPUT CHARACTERISTICS</b>						
Output Voltage High	$V_{OH}$	$R_L = 10\text{ k}\Omega$ to $V_{CM}$	13	13.5		V
		$-40^\circ\text{C} \leq T_A \leq +125^\circ\text{C}$	12.5			V
Output Voltage Low	$V_{OL}$	$R_L = 10\text{ k}\Omega$ to $V_{CM}$		-13.8	-13	V
		$-40^\circ\text{C} \leq T_A \leq +125^\circ\text{C}$			-12.5	V
Short-Circuit Current	$I_{SC}$			20		mA
Closed-Loop Output Impedance	$Z_{OUT}$	$f = 1\text{ kHz}$ , $A_V = 1$		1		$\Omega$
<b>POWER SUPPLY</b>						
Power Supply Rejection Ratio	PSRR					
B Grade (ADA4062-2, 8-Lead SOIC Only)		$V_{SY} = \pm 4\text{ V to } \pm 18\text{ V}$	80	90		dB
		$-40^\circ\text{C} \leq T_A \leq +125^\circ\text{C}$	80			dB
A Grade		$V_{SY} = \pm 4\text{ V to } \pm 18\text{ V}$	74	90		dB
		$-40^\circ\text{C} \leq T_A \leq +125^\circ\text{C}$	70			dB
Supply Current per Amplifier	$I_{SY}$	$I_O = 0\text{ mA}$		165	220	$\mu\text{A}$
		$-40^\circ\text{C} \leq T_A \leq +125^\circ\text{C}$			260	$\mu\text{A}$
<b>DYNAMIC PERFORMANCE</b>						
Slew Rate	SR	$R_L = 10\text{ k}\Omega$ , $C_L = 100\text{ pF}$ , $A_V = 1$		3.3		V/ $\mu\text{s}$
Settling Time	$t_S$	To 0.1%, $V_{IN} = 10\text{ V step}$ , $C_L = 100\text{ pF}$ , $R_L = 10\text{ k}\Omega$ , $A_V = 1$		3.5		$\mu\text{s}$
Gain Bandwidth Product	GBP	$R_L = 10\text{ k}\Omega$ , $A_V = 1$		1.4		MHz
Phase Margin	$\Phi_M$	$R_L = 10\text{ k}\Omega$ , $A_V = 1$		78		Degrees
Channel Separation (ADA4062-2 Only)	CS	$f = 1\text{ kHz}$		135		dB
Channel Separation (ADA4062-4 Only)	CS	$f = 1\text{ kHz}$		130		dB

# ADA4062-2/ADA4062-4

Parameter	Symbol	Conditions	Min	Typ	Max	Unit
NOISE PERFORMANCE						
Voltage Noise	$e_n$ p-p	$f = 0.1 \text{ Hz to } 10 \text{ Hz}$		1.5		$\mu\text{V p-p}$
Voltage Noise Density	$e_n$	$f = 1 \text{ kHz}$		36		$\text{nV}/\sqrt{\text{Hz}}$
Current Noise Density	$i_n$	$f = 1 \text{ kHz}$		5		$\text{fA}/\sqrt{\text{Hz}}$

## ABSOLUTE MAXIMUM RATINGS

Table 3.

Parameter	Rating
Supply Voltage	±18 V
Input Voltage	±V <sub>SY</sub>
Differential Input Voltage	±V <sub>SY</sub>
Input Current	±10 mA
Output Short-Circuit Duration to GND	Indefinite
Storage Temperature Range	−65°C to +150°C
Operating Temperature Range	−40°C to +125°C
Junction Temperature Range	−65°C to +150°C
Lead Temperature (Soldering, 60 sec)	300°C

Stresses above those listed under Absolute Maximum Ratings may cause permanent damage to the device. This is a stress rating only; functional operation of the device at these or any other conditions above those indicated in the operational section of this specification is not implied. Exposure to absolute maximum rating conditions for extended periods may affect device reliability.

## THERMAL RESISTANCE

$\theta_{JA}$  is specified for the worst-case conditions, that is, a device soldered in a circuit board for surface-mount packages. It was measured using a standard 4-layer board.

Table 4. Thermal Resistance

Package Type	$\theta_{JA}$	$\theta_{JC}$	Unit
8-Lead SOIC	120	45	°C/W
8-Lead MSOP	142	45	°C/W
10-Lead LFCSP	132	46	°C/W
14-Lead TSSOP	112	35	°C/W
16-Lead LFCSP	75	12	°C/W

## POWER SEQUENCING

The supply voltages of the op amps must be established simultaneously with, or before, any input signals are applied. If this is not possible, the input current must be limited to 10 mA.

## ESD CAUTION



**ESD (electrostatic discharge) sensitive device.** Charged devices and circuit boards can discharge without detection. Although this product features patented or proprietary protection circuitry, damage may occur on devices subjected to high energy ESD. Therefore, proper ESD precautions should be taken to avoid performance degradation or loss of functionality.

## TYPICAL PERFORMANCE CHARACTERISTICS

$T_A = 25^\circ\text{C}$ , unless otherwise noted.



Figure 5. Input Offset Voltage Distribution



Figure 8. Input Offset Voltage Distribution



Figure 6. Input Offset Voltage Drift Distribution



Figure 9. Input Offset Voltage Drift Distribution



Figure 7. Input Offset Voltage Drift Distribution



Figure 10. Input Offset Voltage Drift Distribution



Figure 11. Input Offset Voltage vs. Common-Mode Voltage



Figure 14. Input Offset Voltage vs. Common-Mode Voltage



Figure 12. Input Bias Current vs. Temperature



Figure 15. Input Bias Current vs. Temperature



Figure 13. Input Bias Current vs. Common-Mode Voltage



Figure 16. Input Bias Current vs. Common-Mode Voltage



Figure 17. Output Voltage to Supply Rail vs. Load Current



Figure 20. Output Voltage to Supply Rail vs. Load Current



Figure 18. Supply Current/Amp vs. Supply Voltage

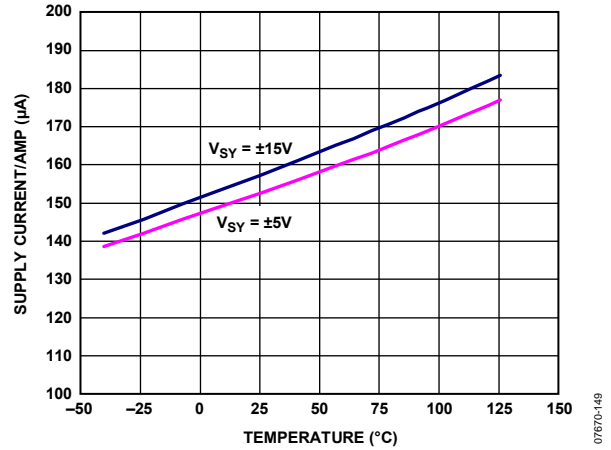

Figure 21. Supply Current/Amp vs. Temperature



Figure 19. Output Voltage to Supply Rail vs. Temperature



Figure 22. Output Voltage to Supply Rail vs. Temperature





Figure 23. Open-Loop Gain and Phase vs. Frequency



Figure 26. Open-Loop Gain and Phase vs. Frequency

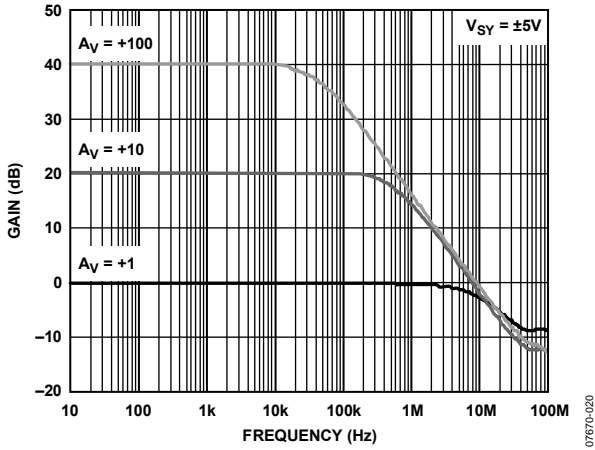

Figure 24. Closed-Loop Gain vs. Frequency

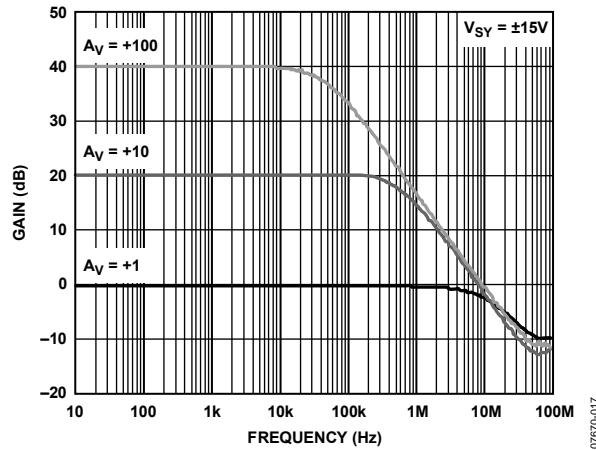

Figure 27. Closed-Loop Gain vs. Frequency

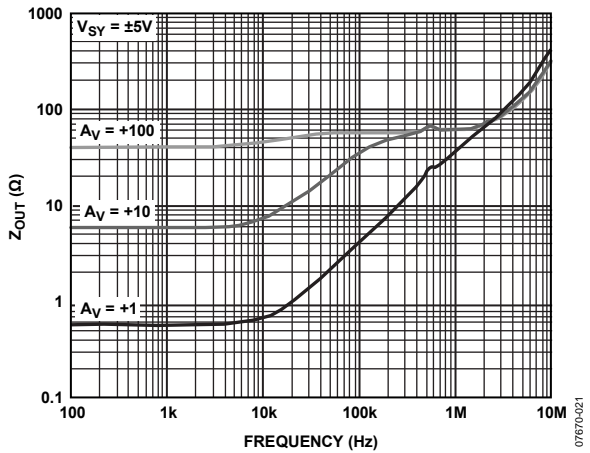

Figure 25. Output Impedance vs. Frequency

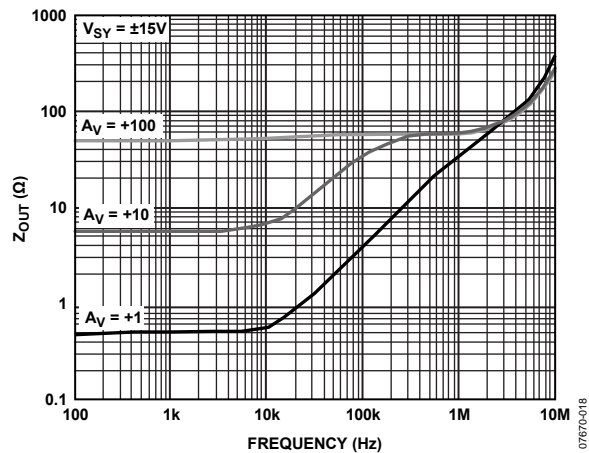

Figure 28. Output Impedance vs. Frequency



Figure 29. CMRR vs. Frequency

07670-025



Figure 32. CMRR vs. Frequency

07670-022



Figure 30. PSRR vs. Frequency

07670-026



Figure 33. PSRR vs. Frequency

07670-023



Figure 31. Small-Signal Overshoot vs. Load Capacitance

07670-030



Figure 34. Small-Signal Overshoot vs. Load Capacitance

07670-027

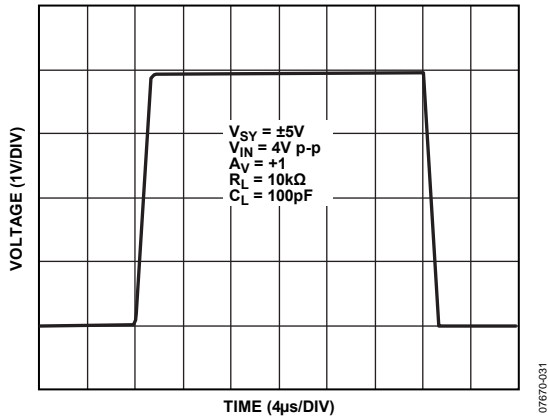

Figure 35. Large-Signal Transient Response

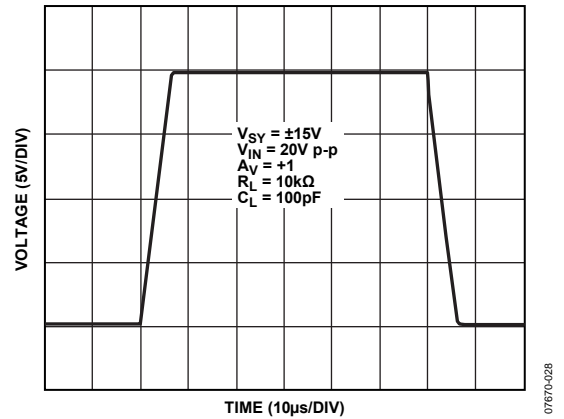

Figure 38. Large-Signal Transient Response

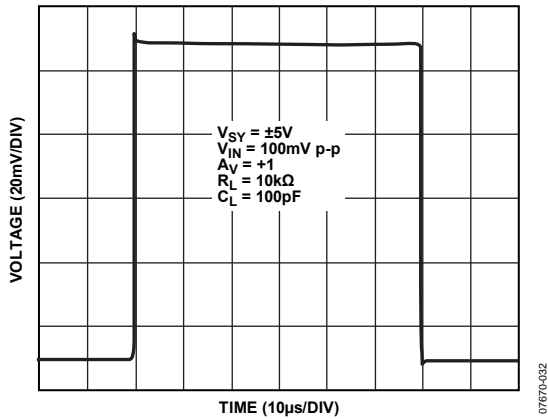

Figure 36. Small-Signal Transient Response

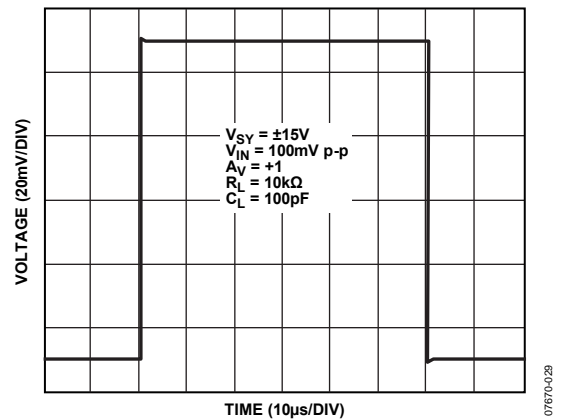

Figure 39. Small-Signal Transient Response

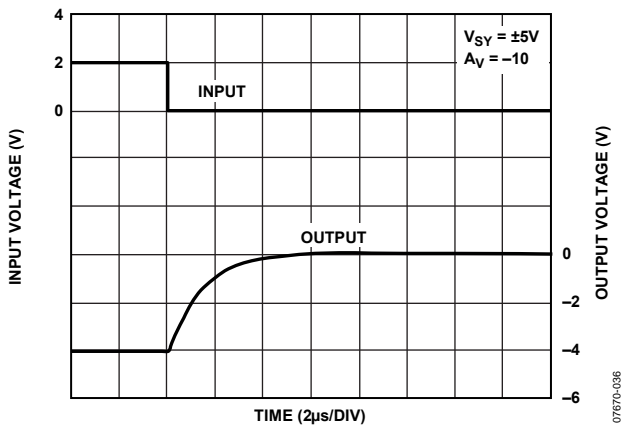

Figure 37. Negative Overload Recovery

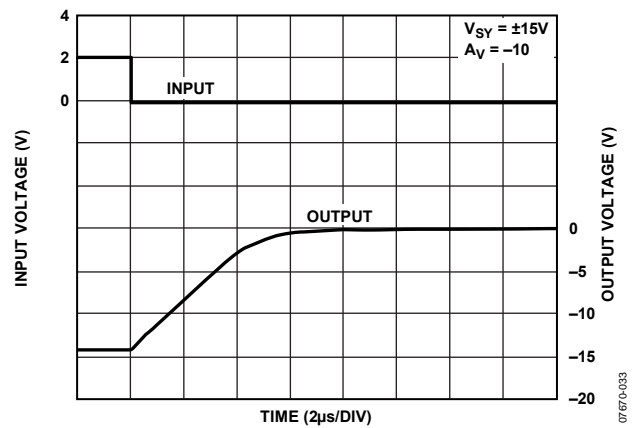

Figure 40. Negative Overload Recovery

# ADA4062-2/ADA4062-4



Figure 41. Positive Overload Recovery

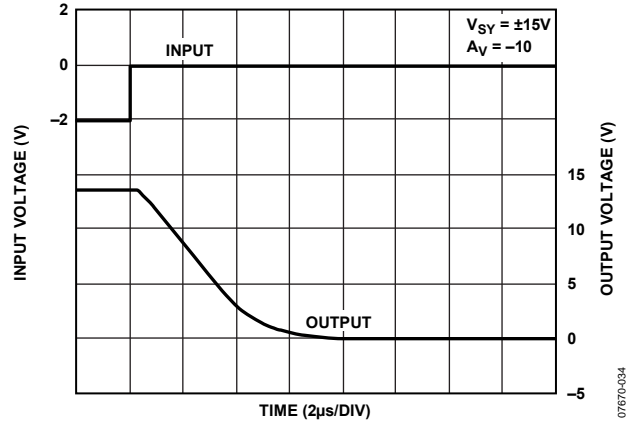

Figure 44. Positive Overload Recovery



Figure 42. Positive Settling Time to 0.1%

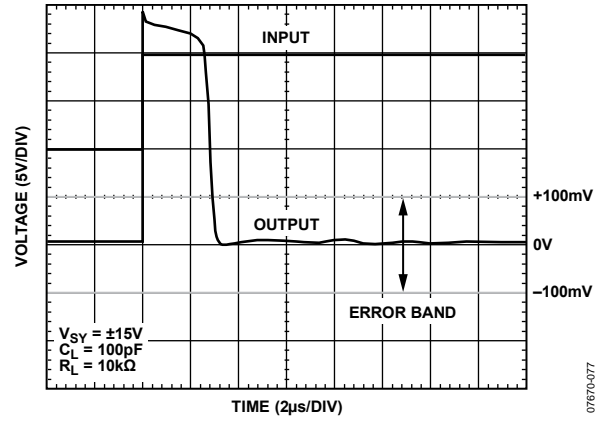

Figure 45. Positive Settling Time to 0.1%



Figure 43. Negative Settling Time to 0.1%

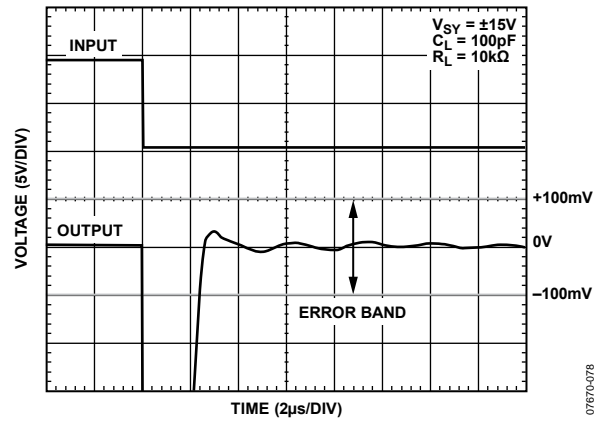

Figure 46. Negative Settling Time to 0.1%

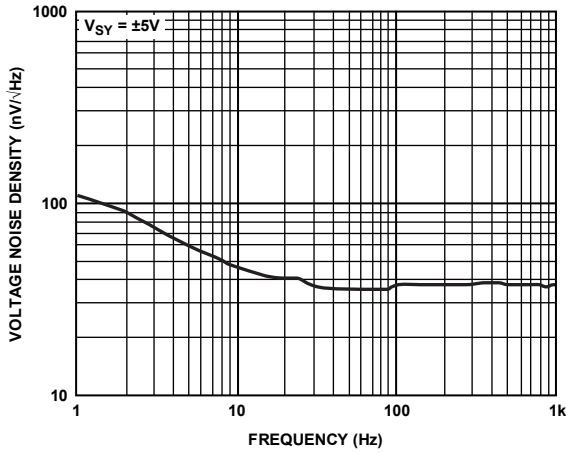

Figure 47. Voltage Noise Density

07670-043

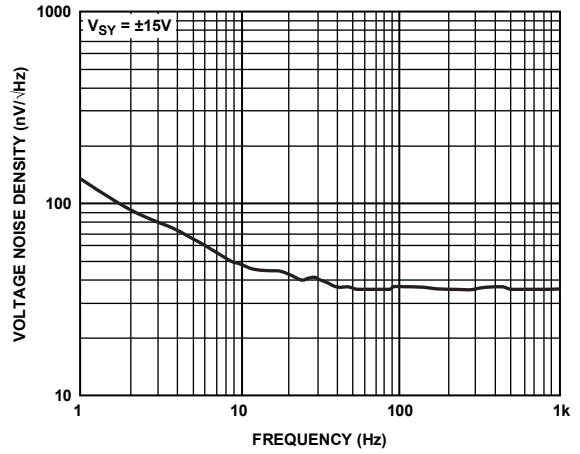

Figure 50. Voltage Noise Density

07670-040

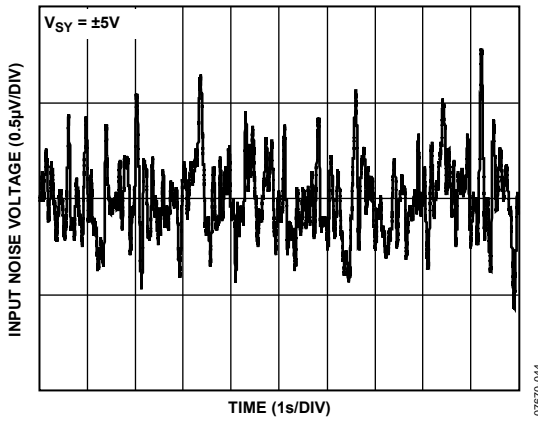

Figure 48. 0.1 Hz to 10 Hz Noise

07670-044

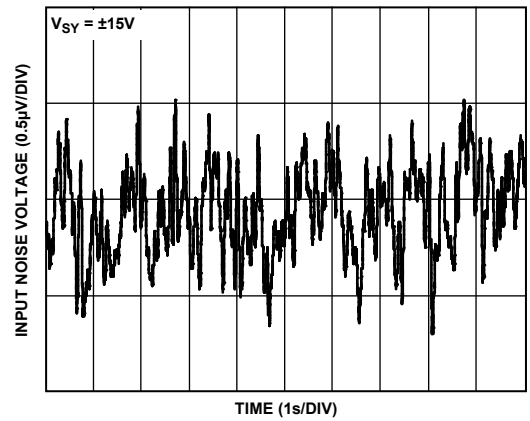

Figure 51. 0.1 Hz to 10 Hz Noise

07670-041

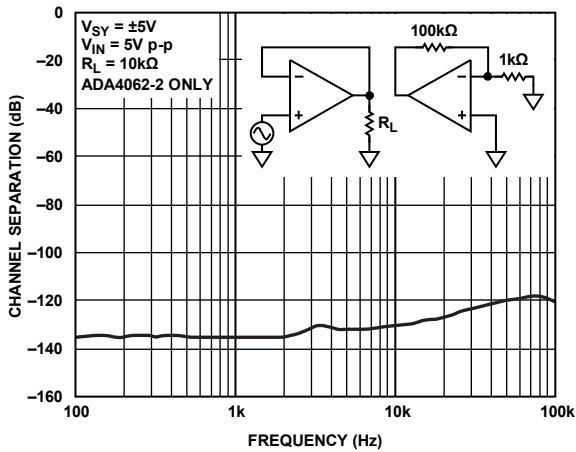

Figure 49. Channel Separation vs. Frequency (ADA4062-2 Only)

07670-048

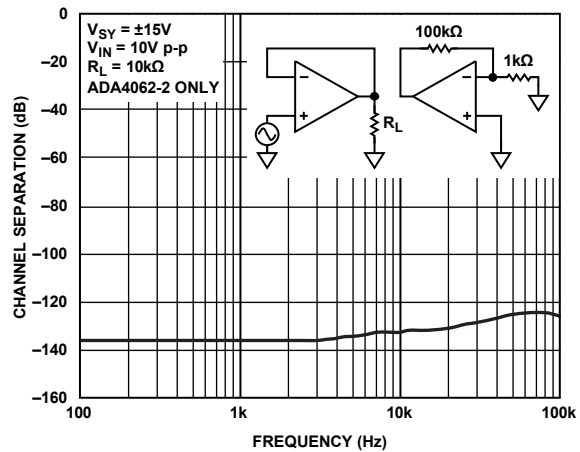

Figure 52. Channel Separation vs. Frequency (ADA4062-2 Only)

07670-046

# ADA4062-2/ADA4062-4



Figure 53. Channel Separation vs. Frequency (ADA4062-4 Only)

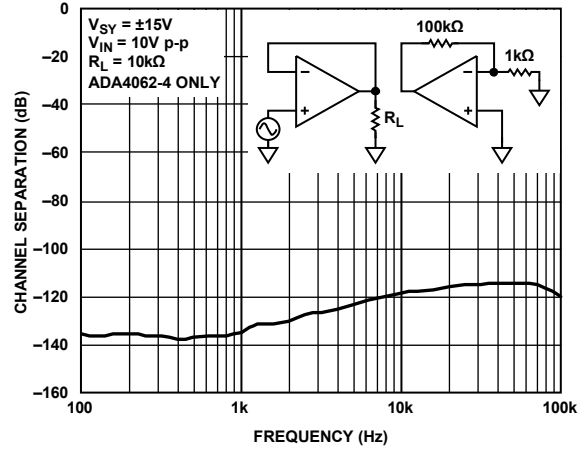

Figure 56. Channel Separation vs. Frequency (ADA4062-4 Only)



Figure 54. THD + N vs. Amplitude

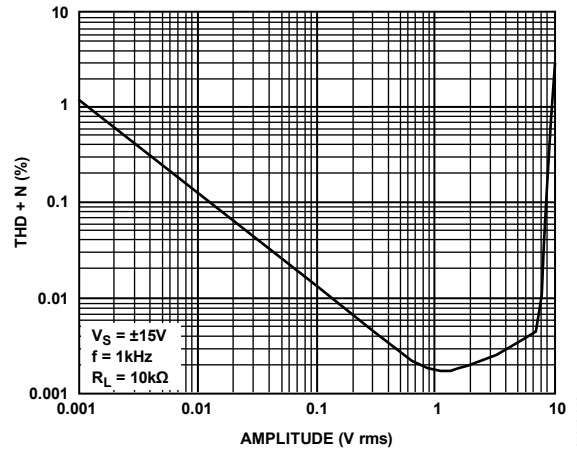

Figure 57. THD + N vs. Amplitude



Figure 55. THD + N vs. Frequency

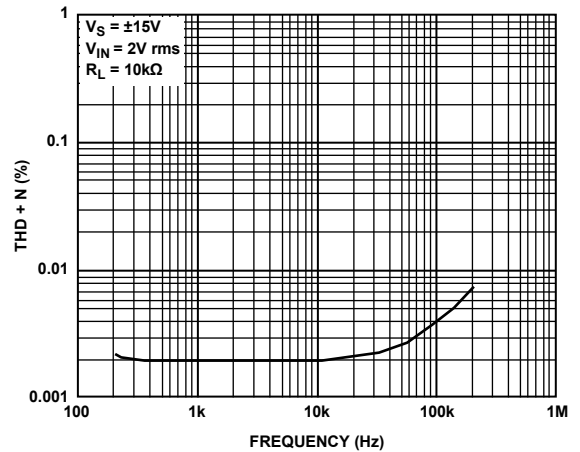

Figure 58. THD + N vs. Frequency

## APPLICATIONS INFORMATION

### NOTCH FILTER

A notch filter rejects a specific interfering frequency and can be implemented using a single op amp. Figure 59 shows a 60 Hz notch filter that uses the twin-T network with the ADA4062-x configured as a voltage follower. The ADA4062-x works as a buffer that provides high input resistance and low output impedance. The low bias current (2 pA typical) and high input resistance (10 TΩ typical) of the ADA4062-x enable large resistors and small capacitors to be used.

Alternatively, different combinations of resistor and capacitor values can be used to achieve the desired notch frequency. However, the major drawback to this circuit topology is the need to ensure that all the resistors and capacitors be closely matched. If they are not closely matched, the notch frequency offset and drift cause the circuit to attenuate at a frequency other than the ideal notch frequency.

Therefore, to achieve the desired performance, 1% or better component tolerances are usually required. In addition, a notch filter requires an op amp with a bandwidth of at least 100× to 200× the center frequency. Hence, using the ADA4062-x with a bandwidth of 1.4 MHz is excellent for a 60 Hz notch filter. Figure 60 shows the frequency response of the notch filter. At 60 Hz, the notch filter has about 50 dB attenuation of signal.

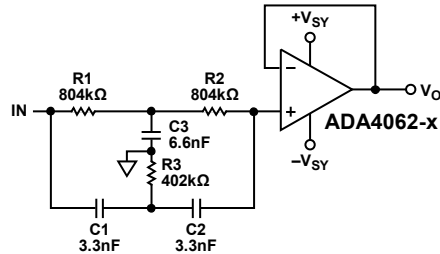

$$f_o = \frac{1}{2\pi R_1 C_1}$$

$$R_1 = R_2 = 2R_3$$

$$C_1 = C_2 = \frac{C_3}{2}$$

Figure 59. Notch Filter Circuit



Figure 60. Frequency Response of the Notch Filter

### HIGH-SIDE SIGNAL CONDITIONING

Many applications require the sensing of signals near the positive rail. The ADA4062-x can be used in high-side current sensing applications. Figure 61 shows a high-side signal conditioning circuit using the ADA4062-x. The ADA4062-x has an input common-mode range that includes the positive supply ( $-11.5\text{ V} \leq V_{CM} \leq +15\text{ V}$ ). In the circuit, the voltage drop across a low value resistor, such as the 0.1 Ω shown in Figure 61, is amplified by a factor of 5 using the ADA4062-x.



Figure 61. High-Side Signal Conditioning

### MICROPOWER INSTRUMENTATION AMPLIFIER

The ADA4062-2 is a dual amplifier and is perfectly suited for applications that require lower supply currents. For supply voltages of ±15 V, the supply current per amplifier is 165 μA typical. The ADA4062-2 also offers a typical low offset voltage drift of 5 μV/°C and a very low bias current of 2 pA, which make it well suited for instrumentation amplifiers.

Figure 62 shows the classic 2-op-amp instrumentation amplifier with four resistors using the ADA4062-2. The key to high CMRR for this instrumentation amplifier are resistors that are well matched to both the resistive ratio and relative drift. For true difference amplification, matching of the resistor ratio is very important, where  $R_3/R_4 = R_1/R_2$ . Assuming perfectly matched resistors, the gain of the circuit is  $1 + R_2/R_1$ , which is approximately 100. Tighter matching of two op amps in one package, as is the case with the ADA4062-2, offers a significant boost in performance over the classical 3-op-amp configuration. Overall, the circuit only requires about 330 μA of supply current.



$$V_o = 100(V_2 - V_1)$$

TYPICAL:  $0.5\text{ mV} < |V_2 - V_1| < 135\text{ mV}$   
 TYPICAL:  $-13.8\text{ V} < V_o < +13.5\text{ V}$   
 USE MATCHED RESISTORS

Figure 62. Micropower Instrumentation Amplifier

## PHASE REVERSAL

Phase reversal occurs in some amplifiers when the input common-mode voltage range is exceeded. When the voltage driving the input to these amplifiers exceeds the maximum input common-mode voltage range, the output of the amplifiers changes polarity. Most JFET input amplifiers have phase reversal if either input exceeds the input common-mode range.

For the ADA4062-x, the output does not phase reverse if one or both of the inputs exceeds the input voltage range but remains within the positive supply rail and 0.5 V above the negative supply rail. In other words, for an application with a supply voltage of  $\pm 15$  V, the input voltage can be as high as +15 V without any output phase reversal. However, when the voltage of the inputs is driven beyond  $-14.5$  V, phase reversal occurs due to saturation of the input stage leading to forward biasing of the gate-drain diode. Phase reversal in ADA4062-x can be prevented by using a Schottky diode to clamp the input terminals to each other. In the simple buffer circuit in Figure 63, D1 protects the op amp against phase reversal, and R limits the input current that flows into the op amp.

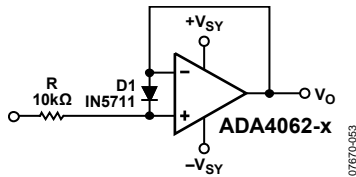

Figure 63. Phase Reversal Solution Circuit

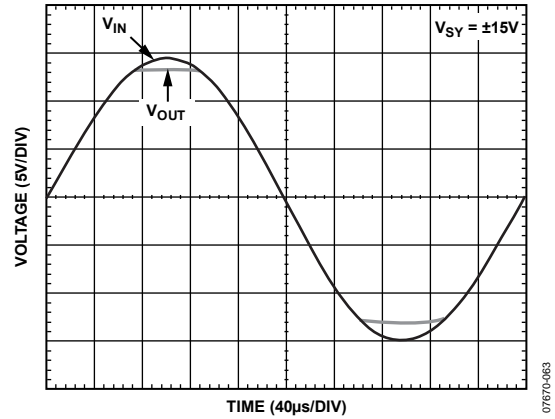

Figure 64. No Phase Reversal



**SCHEMATIC**



Figure 65. Simplified Schematic of the ADA4062-x

07670482

OUTLINE DIMENSIONS



COMPLIANT TO JEDEC STANDARDS MO-187-AA  
 Figure 66. 8-Lead Mini Small Outline Package [MSOP]  
 (RM-8)  
 Dimensions shown in millimeters

100709-B

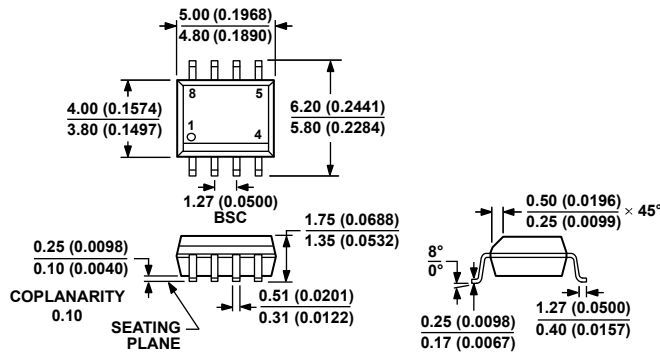

COMPLIANT TO JEDEC STANDARDS MS-012-AA  
 CONTROLLING DIMENSIONS ARE IN MILLIMETERS; INCH DIMENSIONS  
 (IN PARENTHESES) ARE ROUNDED-OFF MILLIMETER EQUIVALENTS FOR  
 REFERENCE ONLY AND ARE NOT APPROPRIATE FOR USE IN DESIGN.  
 Figure 67. 8-Lead Standard Small Outline Package [SOIC\_N]  
 Narrow Body (R-8)  
 Dimensions shown in millimeters and (inches)

012407-A

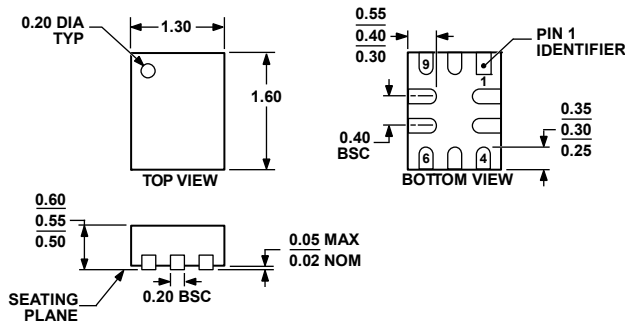

Figure 68. 10-Lead Lead Frame Chip Scale Package [LFCSP\_UQ]  
 1.30 mm x 1.60 mm, Body, Ultra Thin Quad  
 (CP-10-10)  
 Dimensions shown in millimeters

033007-A



COMPLIANT TO JEDEC STANDARDS MO-153-AB-1

Figure 69. 14-Lead Thin Shrink Small Outline Package [TSSOP] (RU-14)

Dimensions shown in millimeters

061908-A

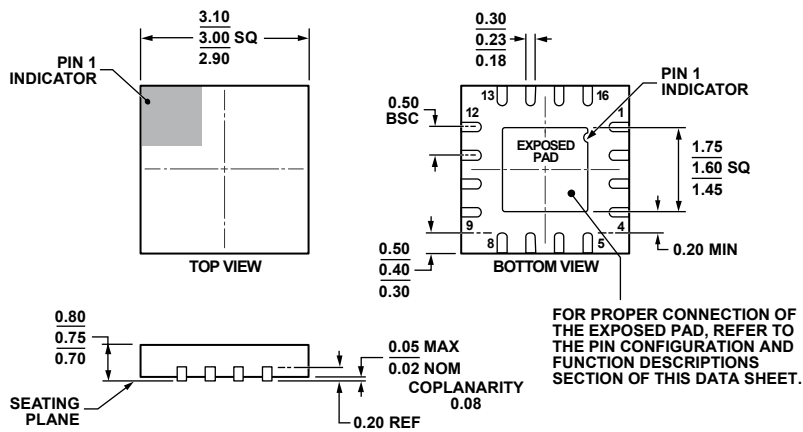

COMPLIANT TO JEDEC STANDARDS MO-220-WEED-6.

Figure 70. 16-Lead Lead Frame Chip Scale Package [LFCSP\_WQ] 3 mm x 3 mm Body, Very Very Thin Quad (CP-16-22)

Dimensions shown in millimeters

01-13-2010-D

# ADA4062-2/ADA4062-4

## ORDERING GUIDE

Model <sup>1</sup>	Temperature Range	Package Description	Package Option	Branding
ADA4062-2ARMZ	-40°C to +125°C	8-Lead MSOP	RM-8	A25
ADA4062-2ARMZ-RL	-40°C to +125°C	8-Lead MSOP	RM-8	A25
ADA4062-2ARMZ-RL7	-40°C to +125°C	8-Lead MSOP	RM-8	A25
ADA4062-2ARZ	-40°C to +125°C	8-Lead SOIC_N	R-8	
ADA4062-2ARZ-R7	-40°C to +125°C	8-Lead SOIC_N	R-8	
ADA4062-2ARZ-RL	-40°C to +125°C	8-Lead SOIC_N	R-8	
ADA4062-2BRZ	-40°C to +125°C	8-Lead SOIC_N	R-8	
ADA4062-2BRZ-R7	-40°C to +125°C	8-Lead SOIC_N	R-8	
ADA4062-2BRZ-RL	-40°C to +125°C	8-Lead SOIC_N	R-8	
ADA4062-2ACPZ-R2	-40°C to +125°C	10-Lead LFCSP_UQ	CP-10-10	J
ADA4062-2ACPZ-RL	-40°C to +125°C	10-Lead LFCSP_UQ	CP-10-10	J
ADA4062-2ACPZ-R7	-40°C to +125°C	10-Lead LFCSP_UQ	CP-10-10	J
ADA4062-4ARUZ	-40°C to +125°C	14-Lead TSSOP	RU-14	
ADA4062-4ARUZ-RL	-40°C to +125°C	14-Lead TSSOP	RU-14	
ADA4062-4ACPZ-R2	-40°C to +125°C	16-Lead LFCSP_WQ	CP-16-22	A2K
ADA4062-4ACPZ-R7	-40°C to +125°C	16-Lead LFCSP_WQ	CP-16-22	A2K
ADA4062-4ACPZ-RL	-40°C to +125°C	16-Lead LFCSP_WQ	CP-16-22	A2K

<sup>1</sup> Z = RoHS Compliant Part.

## Данный компонент на территории Российской Федерации

### Вы можете приобрести в компании MosChip.

Для оперативного оформления запроса Вам необходимо перейти по данной ссылке:

<http://moschip.ru/get-element>

Вы можете разместить у нас заказ для любого Вашего проекта, будь то серийное производство или разработка единичного прибора.

В нашем ассортименте представлены ведущие мировые производители активных и пассивных электронных компонентов.

Нашей специализацией является поставка электронной компонентной базы двойного назначения, продукции таких производителей как XILINX, Intel (ex.ALTERA), Vicor, Microchip, Texas Instruments, Analog Devices, Mini-Circuits, Amphenol, Glenair.

Сотрудничество с глобальными дистрибьюторами электронных компонентов, предоставляет возможность заказывать и получать с международных складов практически любой перечень компонентов в оптимальные для Вас сроки.

На всех этапах разработки и производства наши партнеры могут получить квалифицированную поддержку опытных инженеров.

Система менеджмента качества компании отвечает требованиям в соответствии с ГОСТ Р ИСО 9001, ГОСТ РВ 0015-002 и ЭС РД 009

### Офис по работе с юридическими лицами:

105318, г.Москва, ул.Щербаковская д.3, офис 1107, 1118, ДЦ «Щербаковский»

Телефон: +7 495 668-12-70 (многоканальный)

Факс: +7 495 668-12-70 (доб.304)

E-mail: [info@moschip.ru](mailto:info@moschip.ru)

Skype отдела продаж:

moschip.ru

moschip.ru\_4

moschip.ru\_6

moschip.ru\_9