

# SPECIFICATION

## PATENT PENDING

Part No.	:	<b>WDP.2458.25.4.B.02</b>
Product Name	:	Wi-Fi Dual-band 2.4/5 GHz Embedded Ceramic Patch Antenna 6dBi+ at 2.4GHz 6dBi+ on 5 to 6 GHz
Features	:	25mm*25mm*4mm 2400MHz to 2500MHz/5150MHz to 5850Mhz Pin Type Supports IEEE 802.11 Dual-band Wi-Fi systems Dual linear polarization Tuned for 70x70mm ground plane

RoHS Compliant



## 1. Introduction

This unique patent pending high gain, high efficiency embedded ceramic patch antenna is designed for professional Wi-Fi dual-band IEEE 802.11 applications. It is mounted via pin and double-sided adhesive. The passive patch offers stable high gain response from 4 dBi to 6dBi on the 2.4GHz band and from 5dBi to 8dBi on the 5 ~6 GHz band. Efficiency values are impressive also across the bands with on average 60%+.

The WDP.25's high gain, high efficiency performance is the perfect solution for directional dual-band WiFi application which need long range but which want to use small compact embedded antennas. The much higher gain and efficiency of the WDP.25 over smaller less efficient more omni-directional chip antennas (these typically have no more than 2dBi gain, 30% efficiencies) means it can deliver much longer range over a wide sector.

Typical applications are

Access Points

Tablets

High definition high throughput video streaming routers

High data MIMO bandwidth routers

Automotive

Home and industrial in-wall WiFi automation

Drones/Quad-copters

UAV

Long range WiFi remote control applications

The WDP patch antenna has two distinct linear polarizations, on the 2.4 and 5GHz bands, increasing isolation between bands.

Custom tuned versions for different ground-planes and housing environments can be made subject to a minimum order quantity.

Contact your regional Taoglas office for support to integrate and test this antenna performance in your device.

## 2. Specification

ELECTRICAL		
Frequency Range (MHz)	2400-2500	5150-5850
Return Loss (dB)	Min. -19, -2 at edge	<-5
Antenna Efficiency (%)	Max. 80, 25+ at edge	50+ in bands
Antenna Peak Gain (dBi)	6	8
Antenna Polarization	Linear	
Impedance	50 ohm	
Input Power	10W	
MECHANICAL		
Dimension (mm)	25x25x4	
ENVIRONMENTAL RATINGS		
Frequency Temp Coefficient (Tf)	0±20ppm/°C	
Operating Temperature	-40°C to +105°C	
Humidity	Non-condensing 65°C 95% RH	

\*All tests done on a 70mm\*70mm ground plane.



### 3. Antenna Characteristics

#### 3.1 Return Loss

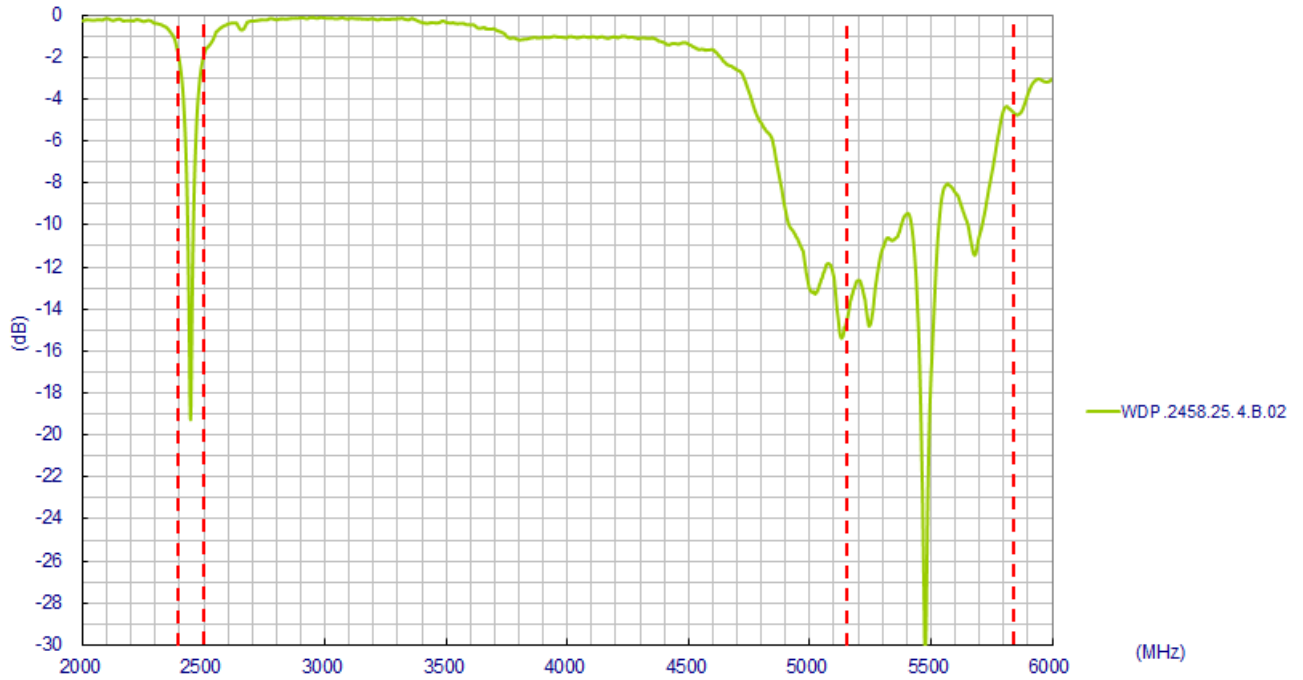

#### 3.2 Peak Gain

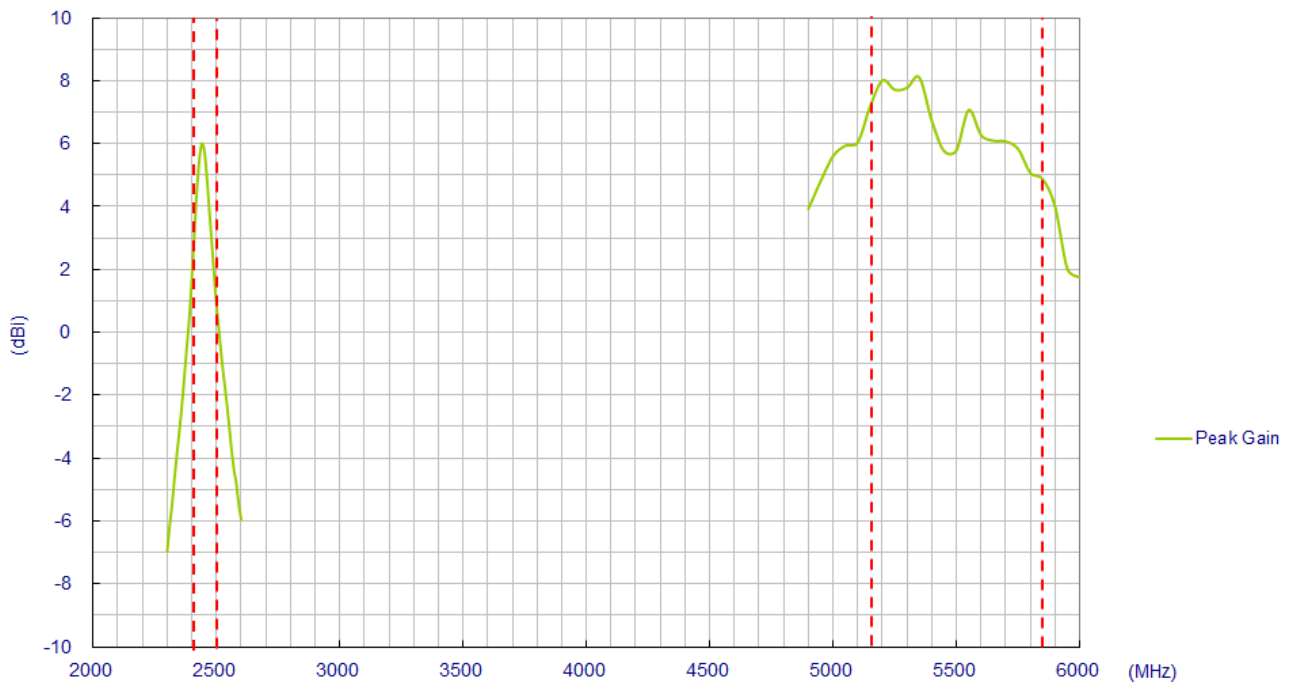

### 3.3 Average Gain

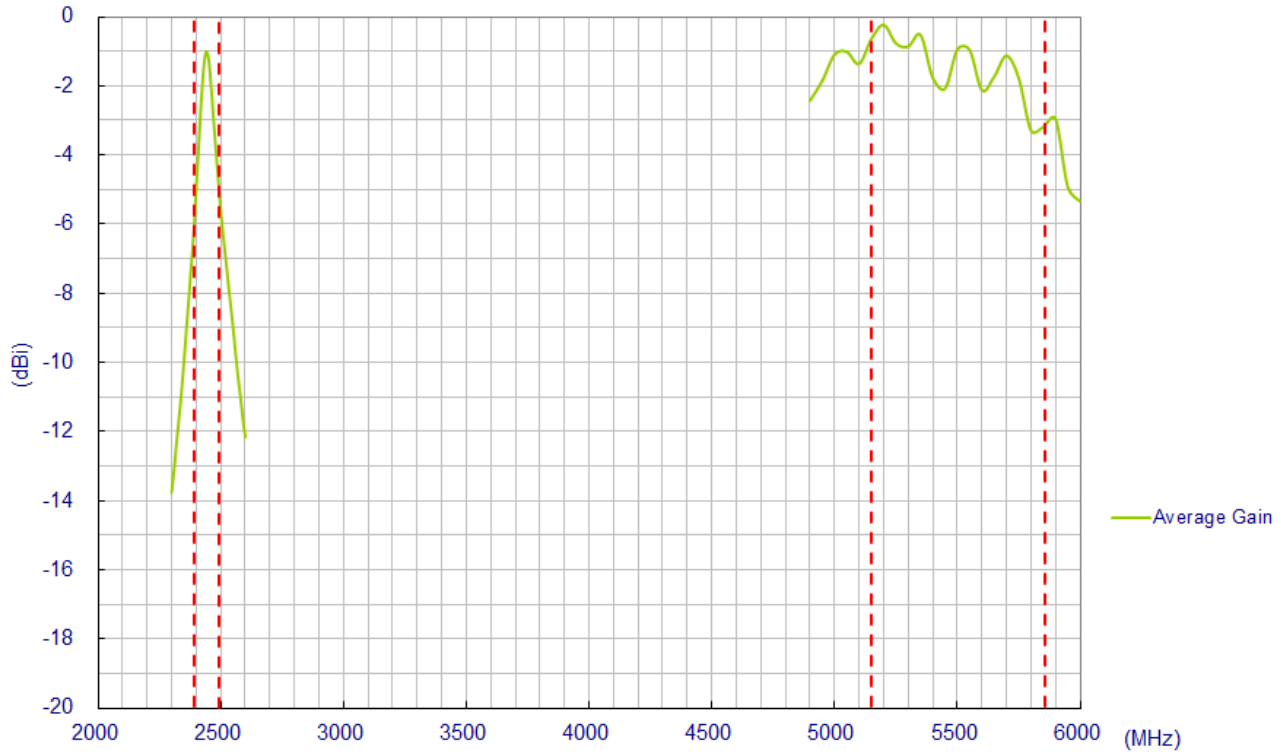

### 3.4 Efficiency

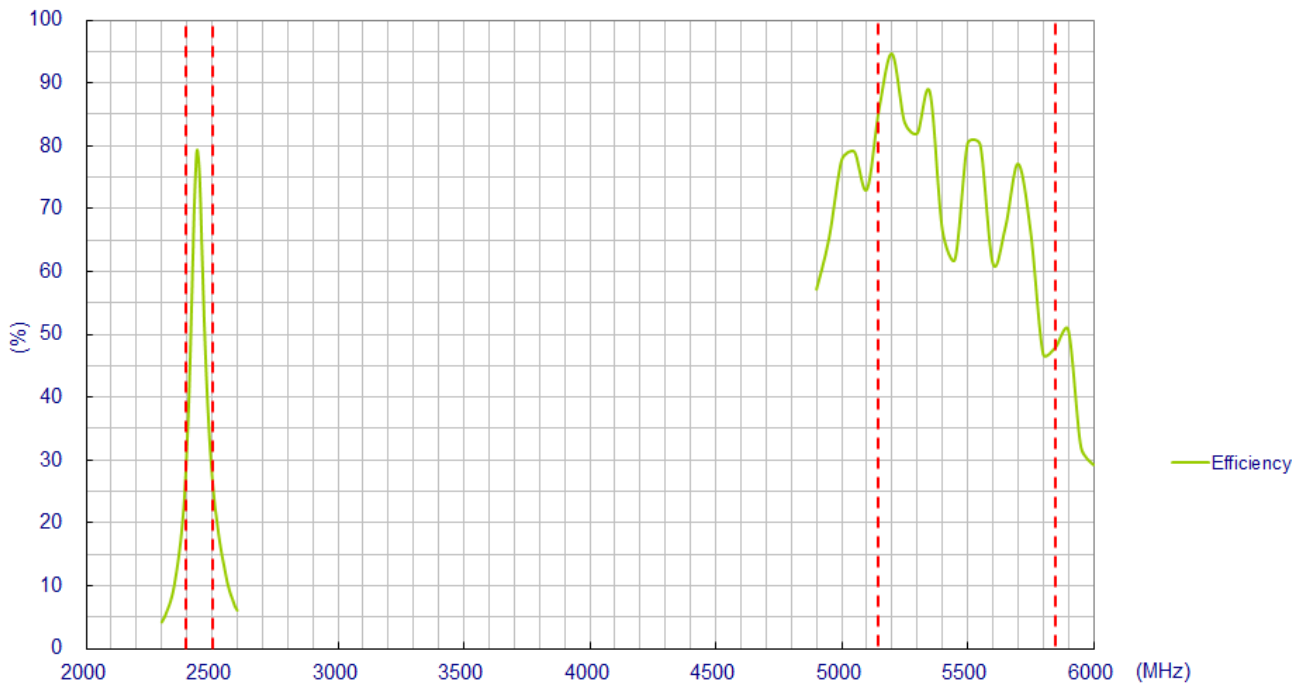

## 4. Antenna Radiation Patterns

### 4.1 Antenna setup

The antenna radiation pattern measurement setup as shown below,

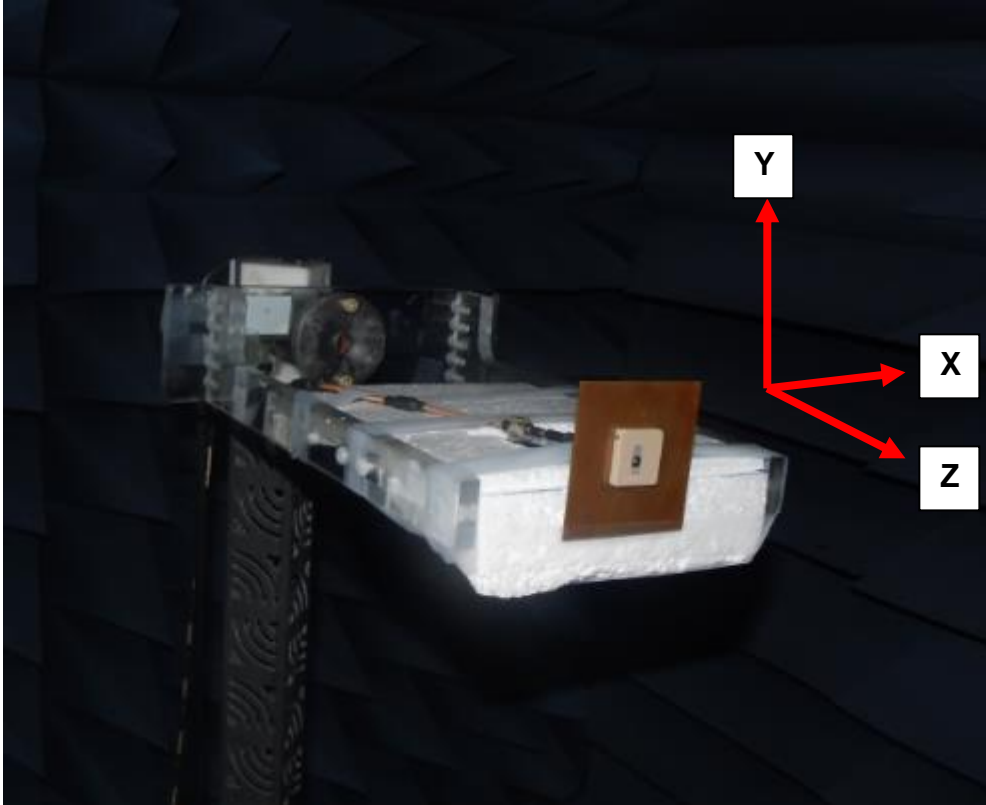

## 4.2 Antenna radiation patterns

### XY-Plane

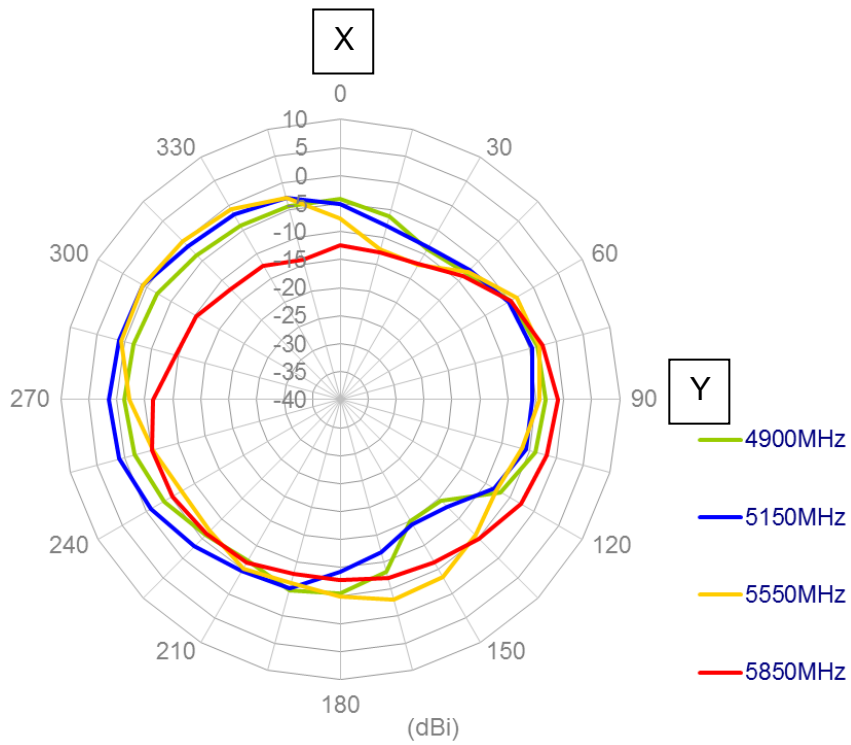
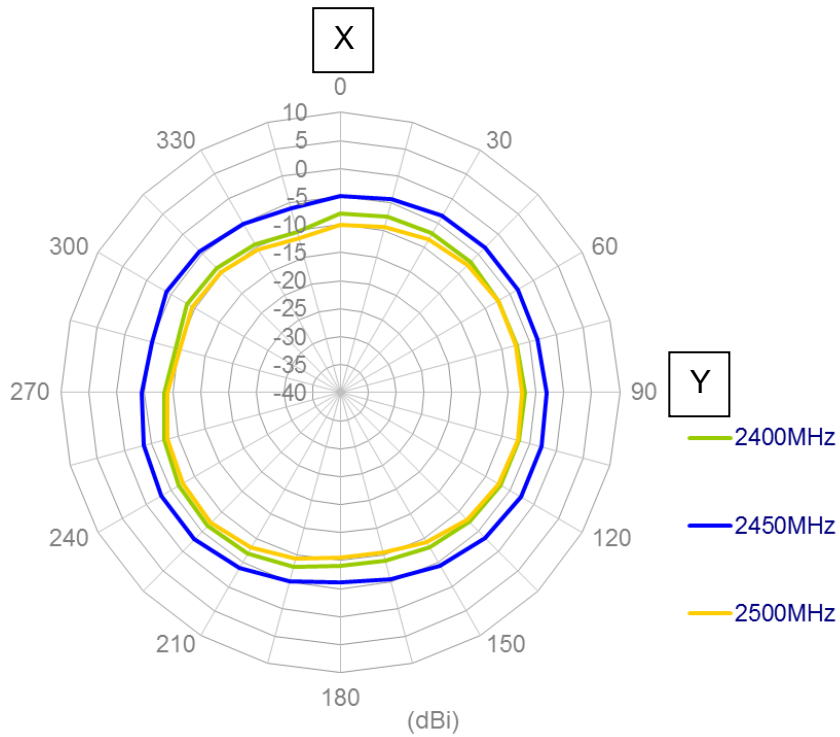

### XZ-Plane

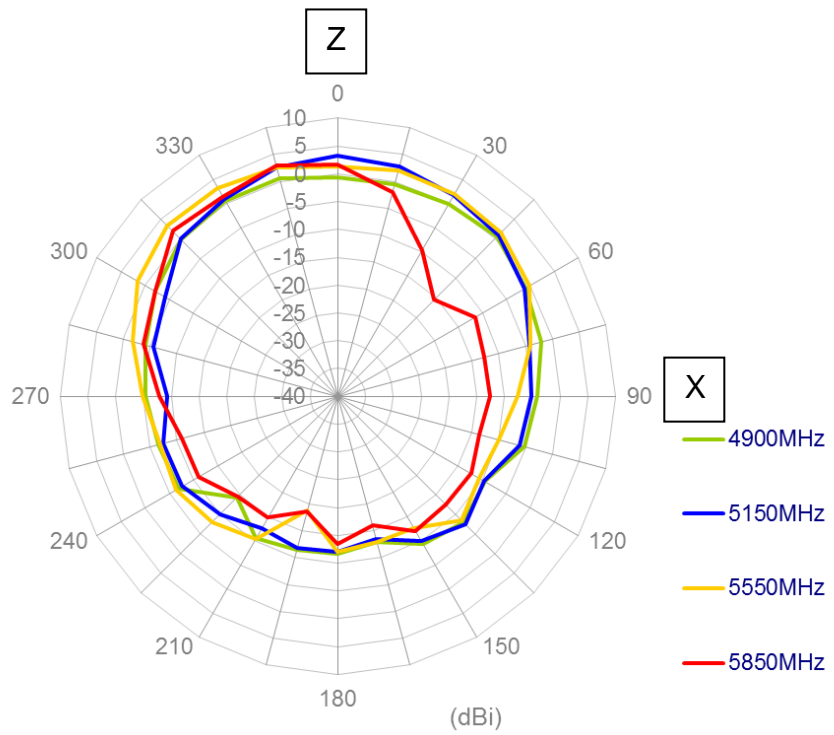
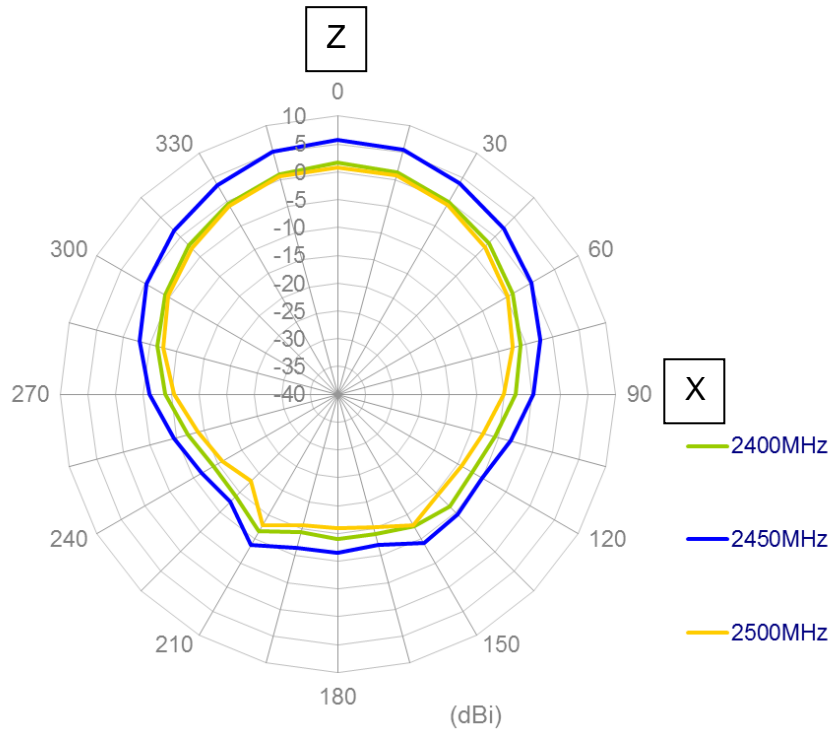



### YZ-Plane

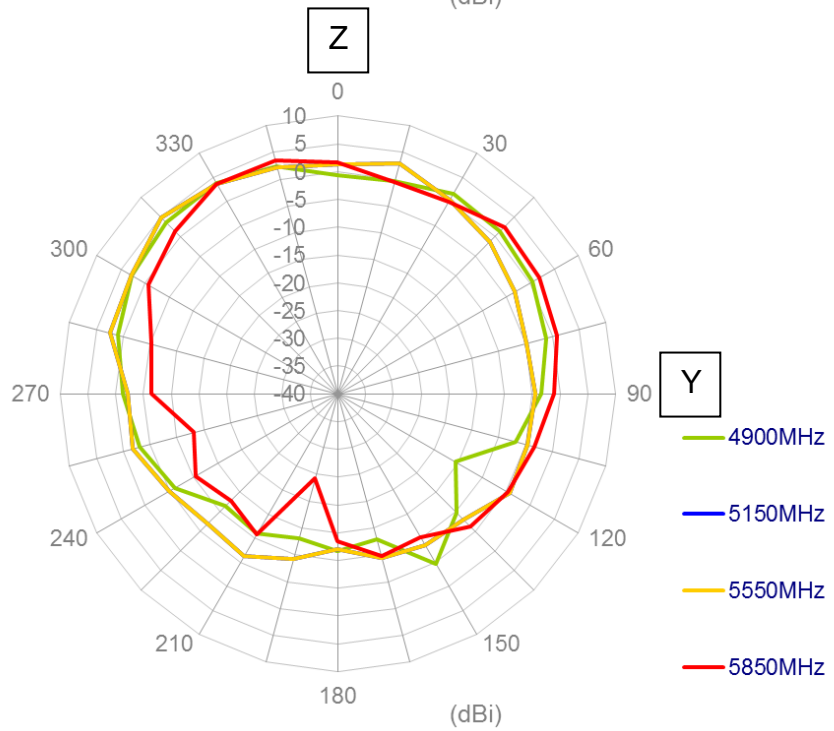
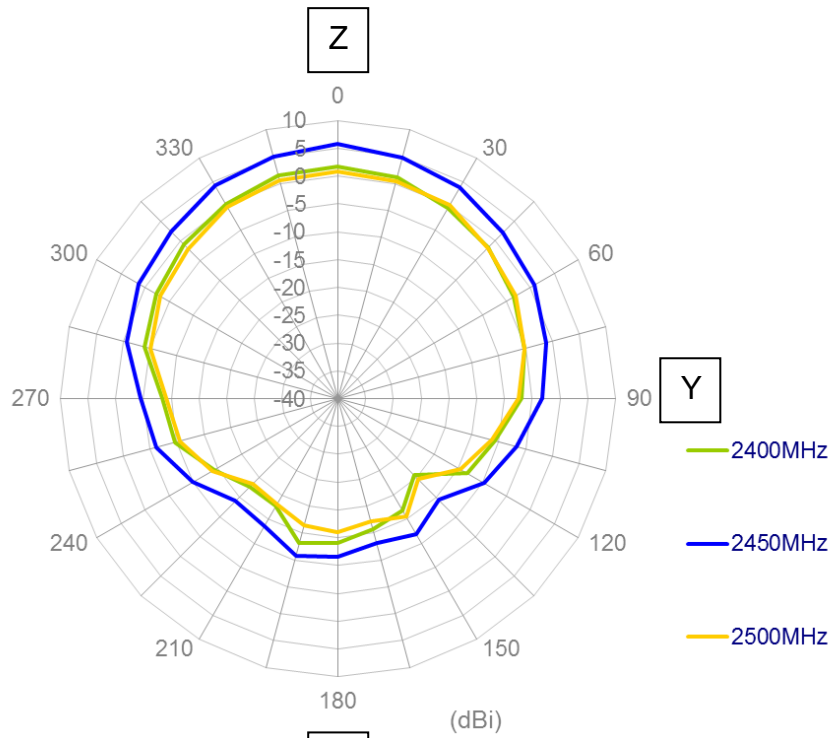

## 5. DRAWING

### 5.1 Patch

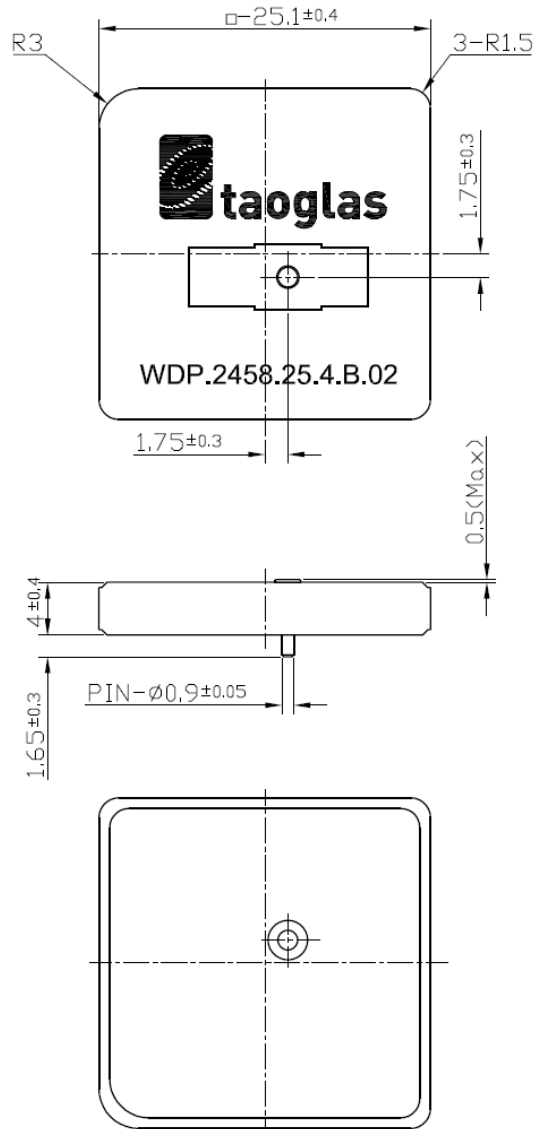

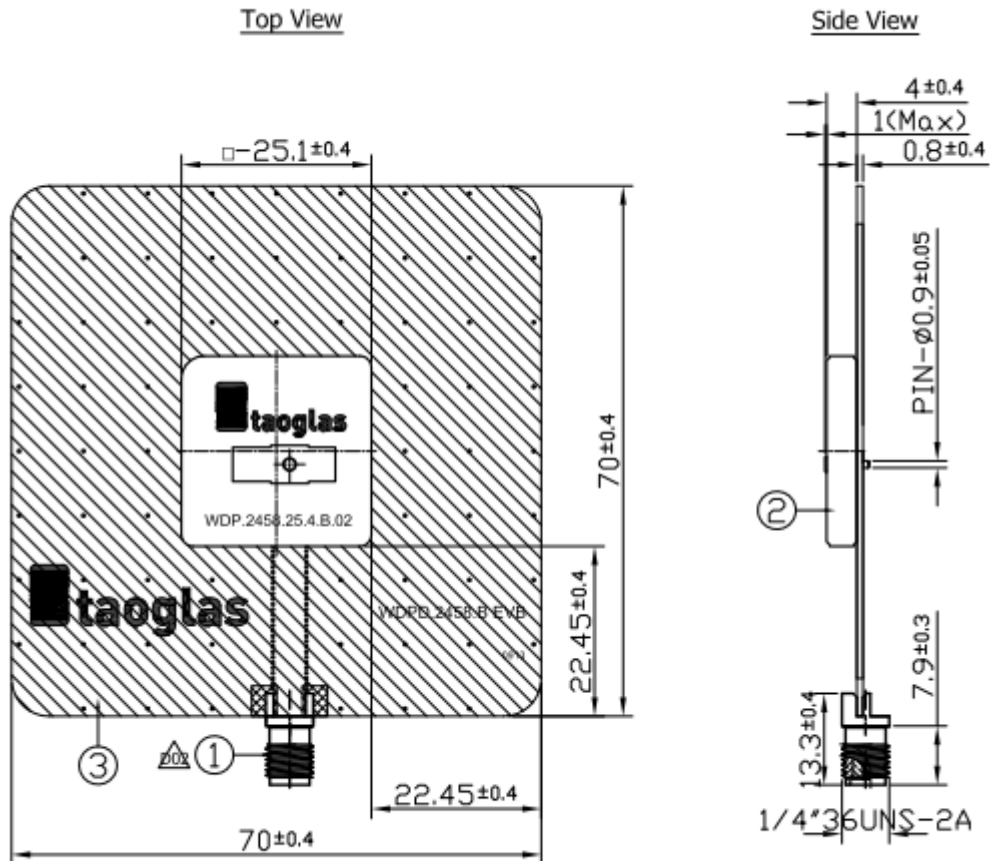

	Name	P/N	Material	Finish	QTY
1	25x25x4 2400~5850MHz Patch Antenna	001514A020007A	Ceramic	N/A	1

## 5.2 Evaluation Board



### Notes

1. Soldermask: 
2. Tin Lay: 

	Name	Material	Finish	QTY
1	EMPCB SMA(F) ST	Brass	Gold	1
2	WDP.2458.25.4.B.02 Patch (25x25x4mm)	Ceramic	Clear	1
3	WDPD.2458.B EVB PCB (70x70x0.8mm)	FR4 0.8t	Black	1

## 6. Packaging

### 6.1 Inner Tray

50 pieces per tray

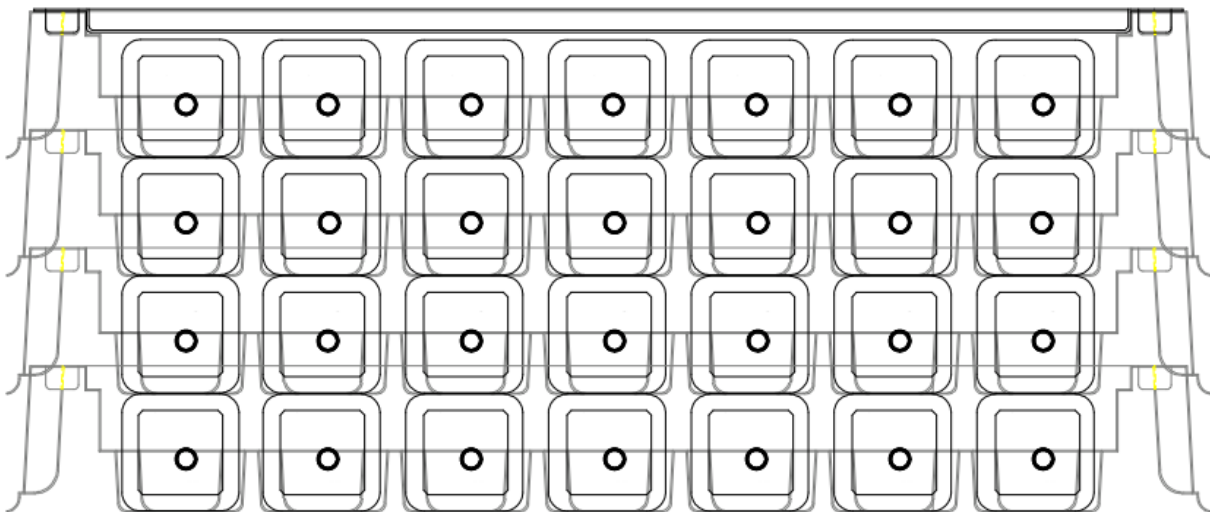
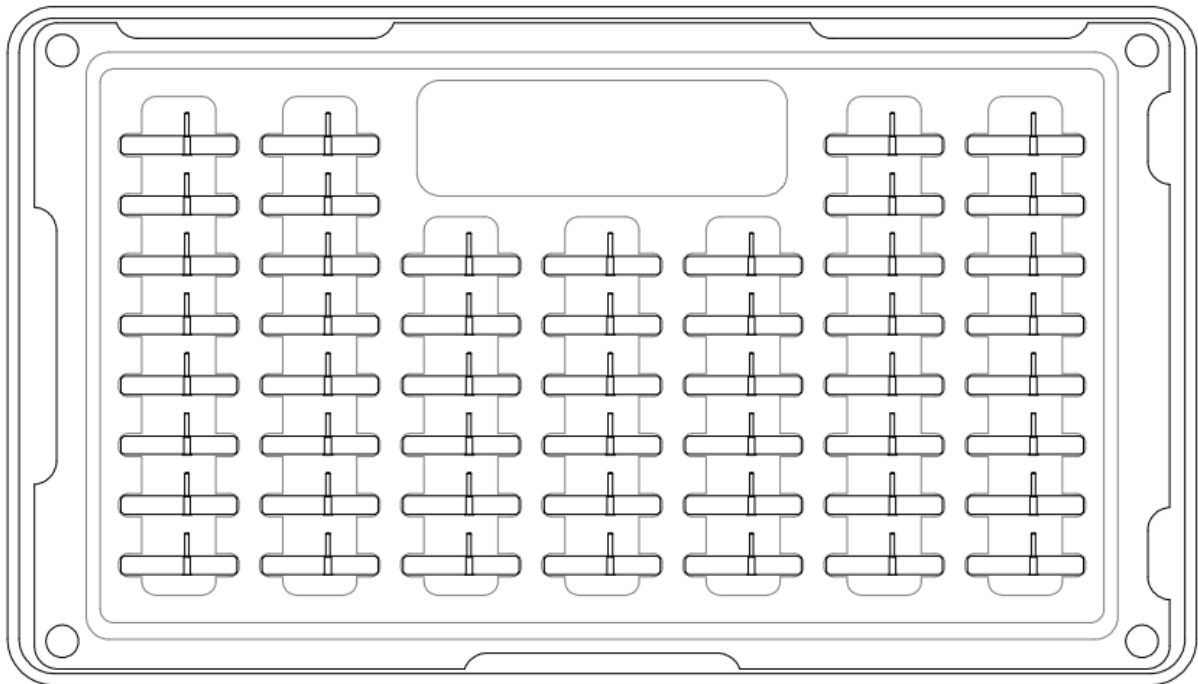

4 Trays per Inside Box = 200

## 6.2 Carton

4 Inside Boxes per Outer Carton -Outer Carton contains 800 pieces

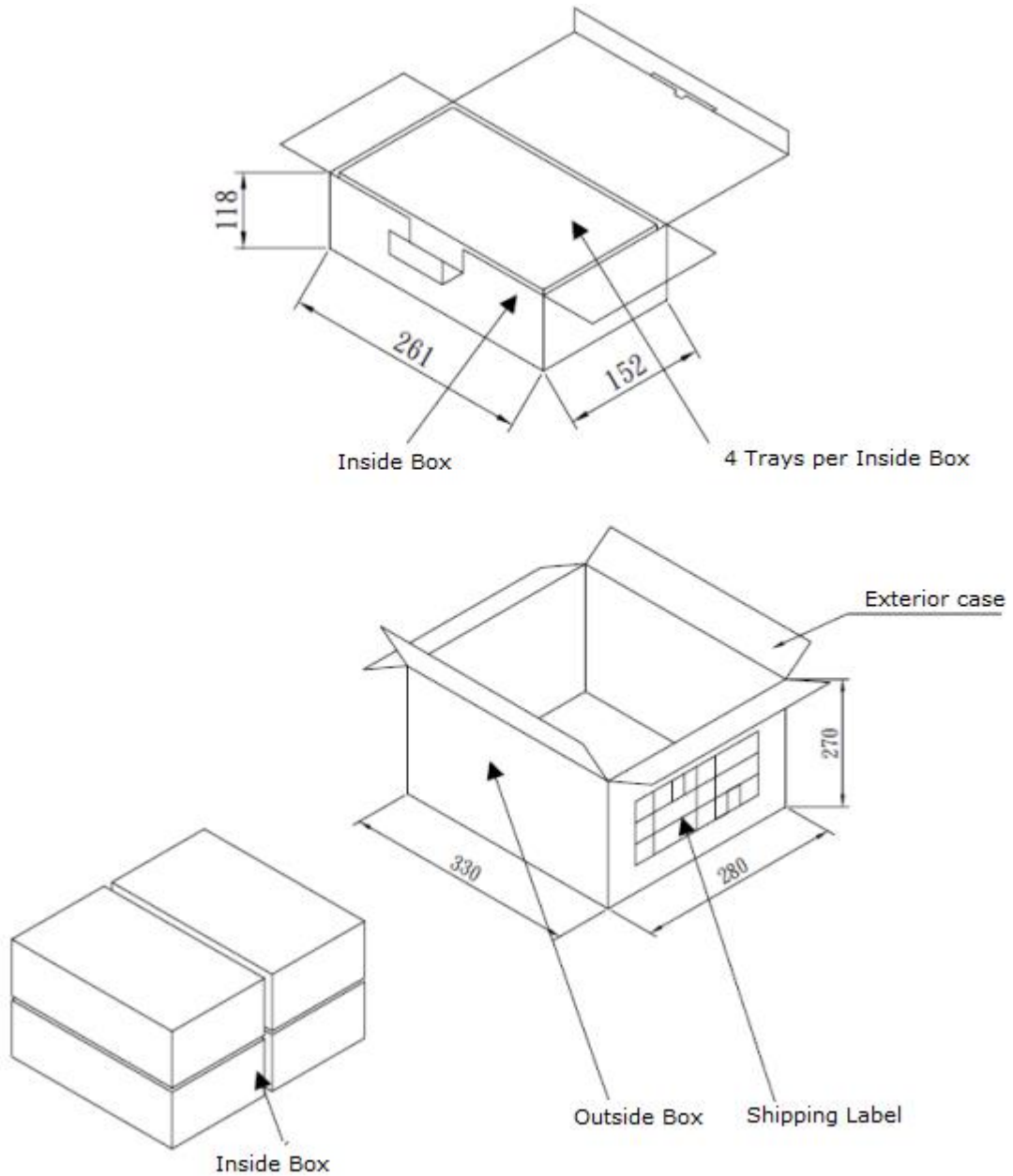

## Данный компонент на территории Российской Федерации

### Вы можете приобрести в компании MosChip.

Для оперативного оформления запроса Вам необходимо перейти по данной ссылке:

<http://moschip.ru/get-element>

Вы можете разместить у нас заказ для любого Вашего проекта, будь то серийное производство или разработка единичного прибора.

В нашем ассортименте представлены ведущие мировые производители активных и пассивных электронных компонентов.

Нашей специализацией является поставка электронной компонентной базы двойного назначения, продукции таких производителей как XILINX, Intel (ex.ALTERA), Vicor, Microchip, Texas Instruments, Analog Devices, Mini-Circuits, Amphenol, Glenair.

Сотрудничество с глобальными дистрибьюторами электронных компонентов, предоставляет возможность заказывать и получать с международных складов практически любой перечень компонентов в оптимальные для Вас сроки.

На всех этапах разработки и производства наши партнеры могут получить квалифицированную поддержку опытных инженеров.

Система менеджмента качества компании отвечает требованиям в соответствии с ГОСТ Р ИСО 9001, ГОСТ РВ 0015-002 и ЭС РД 009

### Офис по работе с юридическими лицами:

105318, г.Москва, ул.Щербаковская д.3, офис 1107, 1118, ДЦ «Щербаковский»

Телефон: +7 495 668-12-70 (многоканальный)

Факс: +7 495 668-12-70 (доб.304)

E-mail: [info@moschip.ru](mailto:info@moschip.ru)

Skype отдела продаж:

moschip.ru

moschip.ru\_4

moschip.ru\_6

moschip.ru\_9