

CTVS – Ceramic transient voltage suppressors

SMD multilayer varistors (MLVs),
automotive E series

Series/Type:

Date: December 2019

Multilayer varistors (MLVs)

Automotive E series

SMD

EPCOS type designation system for automotive series, single chips

| CT | 0603 | S | 14 | B | AUTO | E2 | G2 |
|--|------|---|----|---|------|----|----|
| Construction: CT \triangleq Single chip with nickel barrier termination (AgNiSn) | | | | | | | |
| EAI case sizes: 0402 0603 0805 1206 1210 1812 2220 | | | | | | | |
| Varistor voltage tolerance: K \triangleq $\pm 10\%$, standard L \triangleq $\pm 10\%$, standard S \triangleq Special tolerance | | | | | | | |
| Maximum RMS operating voltage (V_{RMS}): 14 \triangleq 14 V $V_{RMS} < 25$ V are suitable for 12 V DC supply systems $V_{RMS} \geq 25$ V are suitable for 24 V DC supply systems | | | | | | | |
| Special tolerance for the varistor voltage: – \triangleq Standard tolerance A or B \triangleq Special tolerance | | | | | | | |
| – \triangleq Standard series AUTO \triangleq specified for load-dump/ jump-start protection (except CT0603S14BAUTOG and CT0805K17AUTOLCG) | | | | | | | |
| Special features: – \triangleq Standard energy handling capability E2 \triangleq Increased energy handling capability HT \triangleq High temperature version LC \triangleq Low capacitance version CC \triangleq Controlled capacitance version RF \triangleq Radio frequency | | | | | | | |
| Taping mode: G \triangleq Taped, 180-mm reel, 7" G2 \triangleq Taped, 330-mm reel, 13" | | | | | | | |

Multilayer varistors (MLVs)

Automotive E series

SMD

EPCOS type designation system for automotive series, array

| CA | 05 | M2 | S | 10 | T | 100 | H | G |
|---|----|----|---|----|---|-----|---|---|
| Construction: CA \triangleq Array with nickel barrier termination (AgNiSn) | | | | | | | | |
| EAI case sizes: 05 \triangleq 0508 array | | | | | | | | |
| M2 \triangleq Array with two elements | | | | | | | | |
| Varistor voltage tolerance: S \triangleq Special tolerance | | | | | | | | |
| Maximum RMS operating voltage (V_{RMS}): 10 \triangleq 10 V | | | | | | | | |
| Internal coding | | | | | | | | |
| Capacitance value: 100 \triangleq 10 · 10 ⁰ pF \triangleq 100 pF | | | | | | | | |
| Maximum capacitance matching tolerance: H \triangleq 3% | | | | | | | | |
| Taping mode: G \triangleq Taped, 180-mm reel, 7" | | | | | | | | |

Multilayer varistors (MLVs)

Automotive E series

SMD

Features

- Reliable ESD protection up to 30 kV acc. to IEC 61000-4-2, level 4 (8 kV contact, 15 kV air)
- High energy absorption capability
- Low leakage current
- Long-term ESD stability
- Bidirectional protection
- No temperature derating up to 150 °C
- RoHS-compatible, lead-free
- Nickel barrier suitable for lead-free soldering
- Qualification based on AEC-Q200
- PSpice simulation models available

Applications

- Transient overvoltage protection in automotive applications: engine management, airbag, control units, electrohydraulic brake, ABS/ESP, sunroof
- Load-dump protection
- Jump-start protection

Design

- Multilayer technology
- Flammability rating better than UL 94 V-0
- Termination (see “Soldering directions”):
 - CT types with nickel barrier terminations (AgNiSn), recommended for lead-free reflow and wave soldering, and compatible with tin/lead solder.

V/I characteristics and derating curves

V/I and derating curves are attached to the data sheet. The curves are sorted by V_{RMS} and then by case size, which is included in the type designation.

Single chip

Internal circuit



MLV0006-H

Available case sizes:

| EIA | Metric |
|------|--------|
| 0402 | 1005 |
| 0603 | 1608 |
| 0805 | 2012 |
| 1206 | 3216 |
| 1210 | 3225 |
| 1812 | 4532 |
| 2220 | 5750 |

Multilayer varistors (MLVs)

Automotive E series

SMD

Description for ESD/ EMI filter array

The ESD/EMI filter array provides an ideal combination of EMI filtering and ESD protection for high-speed bus system transceivers such as Ethernet and Flexray.

Features

- ESD protection acc. to IEC 61000-4-2, level 4
- Capacitance deviation between array elements
 C_1 and C_2 : < 3%
- Max. relative capacitance change: < 0.1%/K
- Low leakage current
- Load-dump/ jump-start resistant
- Stable protection level
- Bidirectional protection
- No temperature derating up to 125 °C
- RoHS-compatible, lead-free
- Qualification based on AEC-Q200

Applications

- Load-dump protection
- Jump-start protection

Design

- Two multilayer varistors with a common ground CT types with nickel barrier terminations (AgNiSn), recommended for lead-free reflow and wave soldering, and compatible with tin/lead solder.
- Flammability rating better than UL 94 V-0
- Termination (see "Soldering directions"):
 - CT types with nickel barrier terminations (AgNiSn), recommended for lead-free reflow and wave soldering, and compatible with tin/lead solder.

2-fold array

Internal circuit

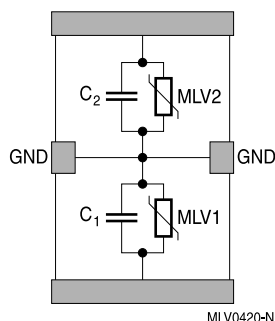

Model of EMI filtering with matched capacitances C_1 and C_2

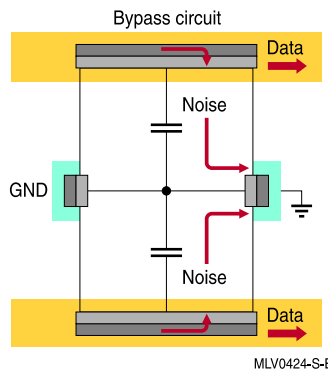

Available case sizes:

| EIA | Metric |
|------|--------|
| 0508 | 1220 |

Multilayer varistors (MLVs)

Automotive E series

SMD

General technical data

| | | | | |
|-------------------------------|----------------|-----------------|-------------|----|
| Maximum RMS operating voltage | | $V_{RMS,max}$ | 10 ... 40 | V |
| Maximum DC operating voltage | | $V_{DC,max}$ | 12 ... 56 | V |
| Maximum surge current | (8/20 μ s) | $I_{surge,max}$ | 2 ... 1200 | A |
| Maximum load dump energy | (10 pulses) | W_{LD} | 1 ... 25 | J |
| Maximum jump-start voltage | (5 min) | V_{jump} | 24.5 ... 45 | V |
| Maximum clamping voltage | | $V_{clamp,max}$ | 35 ... 290 | V |
| Operating temperature | | T_{op} | -55/+150 | °C |
| Storage temperature | | LCT/UCT | -55/+150 | °C |
| Response time | | t_{resp} | < 0.5 | ns |

Temperature derating

Climatic category: -55/+150 °C

for single chips

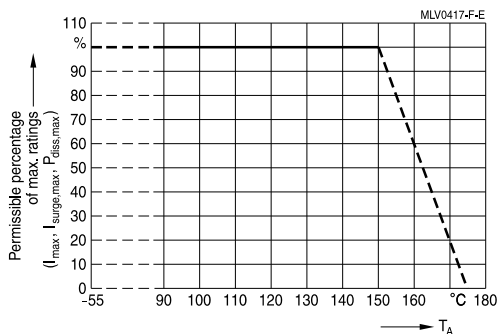

Climatic category: -40/+125 °C

for ESD/ EMI filter array and single chips type CT0402S20AHSG_P/ CT0603S20AHSG_P

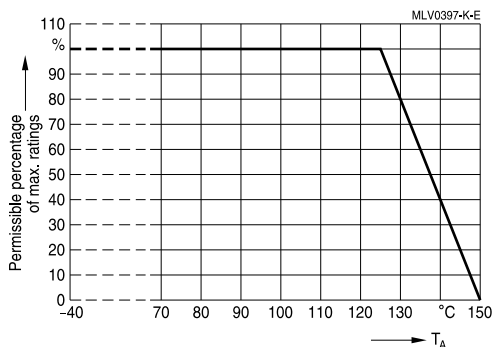

Multilayer varistors (MLVs)
Automotive E series
SMD
Electrical specifications and ordering codes
Maximum ratings ($T_{op,max}$), automotive standard series¹⁾

| Type | Ordering code | $V_{RMS,max}$ | $V_{DC,max}$ | W_{max} | $P_{diss,max}$ | V_V | ΔV_V |
|------------------|-----------------|---------------|--------------|--------------|----------------|-------------|--------------|
| | | V | V | (2 ms) mJ | mW | (1 mA) V | % |
| CT0805K11G | B72510E0110K062 | 11 | 14 | 200 | 5 | 18 | ±10 |
| CT0402L14G | B72590E0140L060 | 14 | 16 | 30 | 3 | 23.5 | ±15 |
| CT0603K14G | B72500E0140K060 | 14 | 18 | 200 | 3 | 22 | ±10 |
| CT0603S14AHSG | B72500E8140S160 | 14 | 16 | 30 | 3 | 28 | ±20 |
| CT0603S14BG | B72500E0140S260 | 14 | 18 | 200 | 3 | 24.5 | ±15 |
| CT0603V150RFG | B72500E7151V060 | 14 | 16 | - | - | 150 | ±35 |
| CT0805K14G | B72510E0140K062 | 14 | 18 | 300 | 3 | 22 | ±10 |
| CT1206K14G | B72520E0140K062 | 14 | 18 | 500 | 8 | 22 | ±10 |
| CT1210K14G | B72530E0140K062 | 14 | 18 | 1500 | 10 | 22 | ±10 |
| CT1812K14G | B72580E0140K062 | 14 | 18 | 2300 | 15 | 22 | ±10 |
| CT2220K14G | B72540E0140K062 | 14 | 18 | 5800 | 20 | 22 | ±10 |
| CT0402S17AG | B72590E0170S160 | 17 | 19 | 10 | 3 | 32.5 | ±25 |
| CT0603K17G | B72500E0170K060 | 17 | 22 | 200 | 3 | 27 | ±10 |
| CT0603K17LCG | B72500E2170K060 | 17 | 22 | 100 | 1 | 27 | ±10 |
| CT0603S17ALCG | B72500E2170S160 | 17 | 22 | 75 | 3 | 32.5 | ±25 |
| CT0603S17BCCG | B72500E5170S260 | 17 | 22 | 75 | 3 | 32.5 | ±25 |
| CT0805K17G | B72510E0170K062 | 17 | 22 | 300 | 5 | 27 | ±10 |
| CT1206K17G | B72520E0170K062 | 17 | 22 | 600 | 8 | 27 | ±10 |
| CT1210K17G | B72530E0170K062 | 17 | 22 | 1700 | 10 | 27 | ±10 |
| CT1812K17G | B72580E0170K062 | 17 | 22 | 2700 | 15 | 27 | ±10 |
| CT2220K17G | B72540E0170K062 | 17 | 22 | 7200 | 20 | 27 | ±10 |
| CT0402S20AHSG_P | B72590P8200S060 | 20 | 24 | - | - | ≥ 100 | - |
| CT0603K20G | B72500E0200K060 | 20 | 26 | 200 | 3 | 33 | ±10 |
| CT0603S20ACCG | B72500E5200S160 | 20 | 26 | 300 | 3 | 36 | ±20 |
| CT0603S20AHSG_P | B72500P8200S060 | 20 | 24 | - | - | ≥ 100 | - |
| CT0805K20G | B72510E0200K062 | 20 | 26 | 300 | 5 | 33 | ±10 |
| CT0805S20ACCG2G2 | B72510E9200S172 | 20 | 26 | 400 | 5 | 34.5 | ±15 |
| CT1206K20G | B72520E0200K062 | 20 | 26 | 700 | 8 | 33 | ±10 |
| CT1210K20G | B72530E0200K062 | 20 | 26 | 1900 | 10 | 33 | ±10 |
| CT1812K20G | B72580E0200K062 | 20 | 26 | 3000 | 15 | 33 | ±10 |
| CT2220K20G | B72540E0200K062 | 20 | 26 | 7800 | 20 | 33 | ±10 |
| CT0603K25G | B72500E0250K060 | 25 | 31 | 300 | 3 | 39 | ±10 |
| CT0603L25HSG | B72500E8250L060 | 25 | 32 | 50 | - | 61 | ±15 |
| CT0603L25HTCCG | B72500E5250L060 | 25 | 32 | 50 | - | 61 | ±15 |
| CT0805K25G | B72510E0250K062 | 25 | 31 | 300 | 5 | 39 | ±10 |

1) W_{LD} and V_{jump} values are not specified for automotive standard series.

Multilayer varistors (MLVs)
Automotive E series
SMD
Characteristics (T_A = 25 °C)

| Type | V _{clamp,max} V | I _{surge,max} (8/20) μs) A | I _{clamp} (8/20) μs) A | C _{typ} ²⁾ pF | C _{min} ²⁾ pF | C _{max} ²⁾ pF | I _{leak,max} μA | I _{leak} μA |
|-----------------|-----------------------------|--|--|--------------------------------------|--------------------------------------|--------------------------------------|-----------------------------|-------------------------|
| CT0805K11G | 35 | 120 | 1 | 400 | - | - | 20@14 V | - |
| CT0402L14G | 46 | 8 | 1 | 15 | - | - | 1@16 V | <1@14 V |
| CT0603K14G | 40 | 30 | 1 | 100 | - | - | 20@18 V | <1@14 V |
| CT0603S14AHSG | 66 | 5 | 1 | 15 | - | 30 | 1@16 V | <1@14 V |
| CT0603S14BG | 42 | 30 | 1 | 120 | - | - | 5@18 V | <1@14 V |
| CT0603V150RFG | 290 | - | 1 | 3 | - | 5 | 3@16 V | - |
| CT0805K14G | 40 | 120 | 1 | 350 | - | - | 30@18V | 1@14 V |
| CT1206K14G | 38 | 200 | 1 | 700 | - | - | 70@18 V | <5@14 V |
| CT1210K14G | 38 | 400 | 2.5 | 2000 | - | - | 70@18 V | <5@14 V |
| CT1812K14G | 38 | 800 | 5 | 4500 | - | - | 90@18 V | <5@14 V |
| CT2220K14G | 38 | 1200 | 10 | 10000 | - | - | 80@18 V | <10@14 V |
| CT0402S17AG | 59 | 6 | 1 | 15 | - | - | 1@16 V | <1@14 V |
| CT0603K17G | 46 | 30 | 1 | 100 | - | - | 30@22 V | <1@14 V |
| CT0603K17LCG | 50 | 10 | 1 | 30 | - | 50 | 20@22 V | <1@14 V |
| CT0603S17ALCG | 50 | 30 | 1 | 50 | - | 75 | 5@22 V | <1@14 V |
| CT0603S17BCCG | 50 | 30 | 1 | 53 | 31.8 | 74.2 | 5@22 V | <1@14 V |
| CT0805K17G | 46 | 120 | 1 | 400 | - | - | 50@22 V | 1@14 V |
| CT1206K17G | 44 | 200 | 1 | 650 | - | - | 70@22 V | <2@14 V |
| CT1210K17G | 44 | 400 | 2.5 | 1800 | - | - | 50@22 V | 1@14 V |
| CT1812K17G | 44 | 800 | 5 | 4000 | - | - | 35@22 V | <2@14 V |
| CT2220K17G | 44 | 1200 | 10 | 9000 | - | - | 70@22 V | <5@14 V |
| CT0402S20AHSG_P | - | - | - | 4.7 | - | 5.7 | 1@24 V | - |
| CT0603K20G | 56 | 30 | 1 | 90 | - | - | 20@26 V | <1@14 V |
| CT0603S20ACCG | 67 | 30 | 1 | 80 | 64 | 96 | 5@26 V | <1@14 V |
| CT0603S20AHSG_P | - | - | - | 4.7 | - | 5.7 | 1@24 V | - |
| CT0805K20G | 56 | 80 | 1 | 300 | - | - | 20@26 V | <1@14 V |
| CT0805S20ACC2G2 | 64 | 80 | 1 | 220 | 170 | 270 | 10@22 V | 1@28 V |
| CT1206K20G | 54 | 200 | 1 | 600 | - | - | 10@26 V | <1@14 V |
| CT1210K20G | 54 | 400 | 2.5 | 1500 | - | - | 20@26 V | 1@14 V |
| CT1812K20G | 54 | 800 | 5 | 3000 | - | - | 60@26 V | <1@14 V |
| CT2220K20G | 54 | 1200 | 10 | 7000 | - | - | 70@26 V | <2@14 V |
| CT0603K25G | 67 | 30 | 1 | 90 | - | - | 10@31 V | 1@28 V |
| CT0603L25HSG | 120 | 5 | 1 | 10 | - | 15 | 1@32 V | <1@14 V |
| CT0603L25HTCCG | 120 | 5 | 1 | 10 | 5 | 15 | 1@32 V | <1@28 V |
| CT0805K25G | 67 | 80 | 1 | 250 | - | - | 25@31 V | 5@28 V |

2) Measurement frequency: f = 1 MHz for C < 100 pF, f = 1 KHz for C ≥ 100 pF

Multilayer varistors (MLVs)
Automotive E series
SMD
Electrical specifications and ordering codes
Maximum ratings ($T_{op,max}$), automotive standard series¹⁾

| Type | Ordering code | $V_{RMS,max}$ | $V_{DC,max}$ | W_{max} | $P_{diss,max}$ | V_V | ΔV_V |
|------------|-----------------|---------------|--------------|--------------|----------------|-------------|--------------|
| | | V | V | (2 ms) mJ | mW | (1 mA) V | % |
| CT1206K25G | B72520E0250K062 | 25 | 31 | 1000 | 8 | 39 | ±10 |
| CT1210K25G | B72530E0250K062 | 25 | 31 | 1700 | 10 | 39 | ±10 |
| CT1812K25G | B72580E0250K062 | 25 | 31 | 3700 | 15 | 39 | ±10 |
| CT2220K25G | B72540E0250K062 | 25 | 31 | 9600 | 20 | 39 | ±10 |
| CT0805K30G | B72510E0300K062 | 30 | 38 | 300 | 5 | 47 | ±10 |
| CT1206K30G | B72520E0300K062 | 30 | 38 | 1100 | 8 | 47 | ±10 |
| CT1210K30G | B72530E0300K062 | 30 | 38 | 2000 | 10 | 47 | ±10 |
| CT1812K30G | B72580E0300K062 | 30 | 38 | 4200 | 15 | 47 | ±10 |
| CT2220K30G | B72540E0300K062 | 30 | 38 | 12000 | 20 | 47 | ±10 |
| CT0805K35G | B72510E0350K062 | 35 | 45 | 300 | 5 | 56 | ±10 |
| CT1206K35G | B72520E0350K062 | 35 | 45 | 400 | 8 | 56 | ±10 |
| CT1210K35G | B72530E0350K062 | 35 | 45 | 2000 | 10 | 56 | ±10 |
| CT1812K35G | B72580E0350K062 | 35 | 45 | 4000 | 15 | 56 | ±10 |
| CT2220K35G | B72540E0350K062 | 35 | 45 | 7700 | 20 | 56 | ±10 |
| CT1206K40G | B72520E0400K062 | 40 | 56 | 500 | 8 | 68 | ±10 |
| CT2220K40G | B72540E0400K062 | 40 | 56 | 9000 | 20 | 68 | ±10 |

1) W_{LD} and V_{jump} values are not specified for automotive standard series.

Multilayer varistors (MLVs)
Automotive E series
SMD
Characteristics (T_A = 25 °C)

| Type | V _{clamp,max} V | I _{surge,max} (8/20 μs) A | I _{clamp} (8/20 μs) A | C _{typ} ²⁾ pF | C _{min} ²⁾ pF | C _{max} ²⁾ pF | I _{leak,max} μA | I _{leak} μA |
|------------|-----------------------------|---|---|--------------------------------------|--------------------------------------|--------------------------------------|-----------------------------|-------------------------|
| CT1206K25G | 65 | 200 | 1 | 550 | - | - | 10@31 V | 2.5@28 V |
| CT1210K25G | 65 | 300 | 2.5 | 1500 | - | - | 25@31 V | 10@28 V |
| CT1812K25G | 65 | 800 | 5 | 2500 | - | - | - | - |
| CT2220K25G | 65 | 1200 | 10 | 5000 | - | - | 110@31 V | <40@28 V |
| CT0805K30G | 77 | 80 | 1 | 200 | - | - | 40@38 V | 1@28 V |
| CT1206K30G | 77 | 200 | 1 | 500 | - | - | 25@38 V | 2@28 V |
| CT1210K30G | 77 | 300 | 2.5 | 1000 | - | - | 20@38 V | 1@28 V |
| CT1812K30G | 77 | 800 | 5 | 2000 | - | - | 70@38 V | 5@28 V |
| CT2220K30G | 77 | 1200 | 10 | 4000 | - | - | 50@38 V | <5@28 V |
| CT0805K35G | 95 | 80 | 1 | 150 | - | - | - | - |
| CT1206K35G | 90 | 100 | 1 | 200 | - | - | 20@45 V | <1@28 V |
| CT1210K35G | 90 | 250 | 2.5 | 600 | - | - | 20@45 V | 1@28 V |
| CT1812K35G | 90 | 500 | 5 | 1200 | - | - | 30@45 V | 1@27 V |
| CT2220K35G | 90 | 1000 | 10 | 2500 | - | - | 50@45 V | <2@28 V |
| CT1206K40G | 110 | 100 | 1 | 250 | - | - | 20@56 V | <1@28 V |
| CT2220K40G | 110 | 1000 | 10 | 2000 | - | - | 120@56 V | <1@28 V |

2) Measurement frequency: f = 1 MHz for C < 100 pF, f = 1 KHz for C ≥ 100 pF

Multilayer varistors (MLVs)
Automotive E series
SMD
Electrical specifications and ordering codes
Maximum ratings ($T_{op,max}$)
Automotive series with load-dump/ jump-start protection¹⁾

| Type | Ordering code | $V_{RMS,max}$ | $V_{DC,max}$ | $I_{surge,max}$ (8/20 μ s) | W_{max} (2 ms) | W_{LD} (10 pulses) | $P_{diss,max}$ |
|--------------------|-----------------|---------------|--------------|-----------------------------------|---------------------|-------------------------|----------------|
| | | V | V | A | mJ | J | mW |
| CT0603S14BAUTOG | B72500E1140S260 | 14 | 16 | 30 | 200 | - | 3 |
| CT0805S14BAUTOG | B72510E1140S262 | 14 | 16 | 120 | 300 | 1 | 8 |
| CT1206S14BAUTOG | B72520E1140S262 | 14 | 16 | 200 | 600 | 1.5 | 8 |
| CT1210S14BAUTOG | B72530E1140S262 | 14 | 16 | 400 | 1600 | 3 | 10 |
| CT1812S14BAUTOE2G2 | B72580E3140S272 | 14 | 16 | 800 | 2400 | 12 | 15 |
| CT1812S14BAUTOG | B72580E1140S262 | 14 | 16 | 800 | 2400 | 6 | 15 |
| CT2220S14BAUTOE2G2 | B72540E3140S272 | 14 | 16 | 1200 | 5800 | 25 | 30 |
| CT2220S14BAUTOG | B72540E1140S262 | 14 | 16 | 1200 | 5800 | 12 | 30 |
| CT0805K17AUTOLCG | B72510E2170K062 | 17 | 22 | 30 | 100 | - | 4 |
| CT1210K17AUTOG | B72530E1170K062 | 17 | 22 | 400 | 1700 | 3 | 10 |
| CT1206K20AUTOG | B72520E1200K062 | 20 | 26 | 200 | 700 | 1.5 | 8 |
| CT1210K20AUTOG | B72530E1200K062 | 20 | 26 | 400 | 1900 | 3 | 10 |
| CT0805K25AUTOG | B72510E1250K062 | 25 | 31 | 80 | 300 | 1 | 5 |
| CT1206K25AUTOG | B72520E1250K062 | 25 | 31 | 200 | 1000 | 1.5 | 8 |
| CT1210K25AUTOG | B72530E1250K062 | 25 | 31 | 300 | 1700 | 3 | 10 |
| CT2220K30AUTOE2G2 | B72540E3300K072 | 30 | 34 | 1200 | 12000 | 25 | 30 |
| CT2220K30AUTOG | B72540E1300K062 | 30 | 34 | 1200 | 12000 | 12 | 30 |

1) C_{min} and C_{max} values are not specified for standard automotive series with load dump/ jump start specification.

Multilayer varistors (MLVs)
Automotive E series
SMD
Characteristics (T_A = 25 °C)

| Type | V _V (1 mA) V | ΔV _V % | V _{jump} (5 min) V | V _{clamp,max} V | I _{clamp} (8/20 μs) A | C _{typ} (1 kHz) pF | I _{leak,max} μA | I _{leak} μA |
|--------------------|-----------------------------------|--------------------------|---------------------------------------|---------------------------------|---|---------------------------------------|---------------------------------|-----------------------------|
| CT0603S14BAUTOG | 24.5 | ±15 | 24.5 | 42 | 1 | 120 | 1@16 V | <1@14 V |
| CT0805S14BAUTOG | 24.5 | ±15 | 24.5 | 42 | 1 | 400 | 5@16 V | 1@14 V |
| CT1206S14BAUTOG | 24.5 | ±15 | 24.5 | 40 | 1 | 800 | 5@16 V | <2.5@14 V |
| CT1210S14BAUTOG | 24.5 | ±15 | 24.5 | 40 | 2.5 | 2000 | 5@16 V | <2.5@14 V |
| CT1812S14BAUTOE2G2 | 24.5 | ±15 | 24.5 | 40 | 5 | 7000 | 10@16 V | 3@14 V |
| CT1812S14BAUTOG | 24.5 | ±15 | 24.5 | 40 | 5 | 5600 | 10@16 V | 3@14 V |
| CT2220S14BAUTOE2G2 | 24.5 | ±15 | 24.5 | 40 | 10 | 15000 | 20@16 V | 10@14 V |
| CT2220S14BAUTOG | 24.5 | ±15 | 24.5 | 40 | 10 | 9500 | 10@16 V | 5@14 V |
| CT0805K17AUTOLCG | 29 | ±15 | - | 50 | 1 | 100 | 10@22 V | 1@14 V |
| CT1210K17AUTOG | 27 | ±10 | 26.5 | 44 | 2.5 | 2000 | 50@22 V | 1@14 V |
| CT1206K20AUTOG | 33 | ±10 | 27 | 54 | 1 | 600 | 10@26 V | <1@14 V |
| CT1210K20AUTOG | 33 | ±10 | 27 | 54 | 2.5 | 1500 | 20@26 V | 1@14 V |
| CT0805K25AUTOG | 39 | ±10 | 29 | 67 | 1 | 250 | 25@22 V | 5@28 V |
| CT1206K25AUTOG | 39 | ±10 | 29 | 65 | 1 | 550 | 10@31 V | 2.5@28 V |
| CT1210K25AUTOG | 39 | ±10 | 29 | 65 | 2.5 | 1500 | 25@31 V | 10@28 V |
| CT2220K30AUTOE2G2 | 47 | ±10 | 45 | 77 | 10 | 10000 | 40@34 V | 10@28 V |
| CT2220K30AUTOG | 47 | ±10 | 45 | 77 | 10 | 4000 | 20@34 V | 5@28 V |

Multilayer varistors (MLVs)
Automotive E series
SMD
Electrical specifications and ordering codes
Maximum ratings ($T_{op,max}$)
Automotive series, array specification

| Type | Ordering code | $V_{RMS,max}$ | $V_{DC,max}$ | $I_{surge,max}$ (8/20 μ s) | W_{max} (2 ms) | V_{LD} (10 pulses, 300 ms) | $P_{diss,max}$ |
|-----------------|-----------------|---------------|--------------|-----------------------------------|---------------------|------------------------------------|----------------|
| | | V | V | A | mJ | V | mW |
| CA05M2S10T100HG | B72812Q1120S160 | 10 | 12 | 5 | 10 | 27 | 3 |

Characteristics ($T_A = 25\text{ }^\circ\text{C}$)

| Type | V_V (1 mA) | ΔV_V | V_{jump} (60 s) | $V_{clamp,max}$ | I_{clamp} (8/20 μ s) | C_{typ} (1 MHz) | C_{max} (1 MHz) | $I_{leak,max}$ |
|-----------------|-----------------|--------------|----------------------|-----------------|-------------------------------|----------------------|----------------------|----------------|
| | V | % | V | V | A | pF | pF | μ A |
| CA05M2S10T100HG | 26 | ± 20 | 28 | 60 | 1 | 10 | 15 | 0.5@5 V |

Note:

Pulse derating curve is not specified for automotive array CA05M2S10T100HG.

Multilayer varistors (MLVs)

Automotive E series

SMD

Dimensional drawings

Single chip



| Case size EIA / mm | l | w | h | k |
|-----------------------|-----------|------------|----------|---------------|
| 0402 / 1005 | 1.0 ±0.15 | 0.50 ±0.10 | 0.6 max. | 0.10 ... 0.30 |
| 0603 / 1608 | 1.6 ±0.15 | 0.80 ±0.10 | 0.9 max. | 0.10 ... 0.40 |
| 0805 / 2012 | 2.0 ±0.20 | 1.25 ±0.15 | 1.4 max. | 0.13 ... 0.75 |
| 1206 / 3216 | 3.2 ±0.30 | 1.60 ±0.20 | 1.7 max. | 0.25 ... 0.75 |
| 1210 / 3225 | 3.2 ±0.30 | 2.50 ±0.25 | 1.7 max. | 0.25 ... 0.75 |
| 1812 / 4532 | 4.5 ±0.40 | 3.20 ±0.30 | 2.5 max. | 0.25 ... 1.00 |
| 2220 / 5750 | 5.7 ±0.40 | 5.00 ±0.40 | 2.5 max. | 0.25 ... 1.00 |

2-fold MCV array



| Case size EIA / mm | l | w | h | d | k | u |
|-----------------------|-----------|------------|----------|------------|------------|------------|
| 0508 / 1220 | 2.0 ±0.20 | 1.25 ±0.15 | 0.9 max. | 0.50 ±0.20 | 0.30 ±0.20 | 0.20 ±0.10 |

Dimensions in mm

Multilayer varistors (MLVs)

Automotive E series

SMD

Recommended solder pad layout

Single chip



Dimensions in mm

| Case size EIA / mm | A | B | C |
|-----------------------|------|------|------|
| 0402 / 1005 | 0.60 | 0.60 | 0.50 |
| 0603 / 1608 | 1.00 | 1.00 | 1.00 |
| 0805 / 2012 | 1.40 | 1.20 | 1.00 |
| 1206 / 3216 | 1.80 | 1.20 | 2.10 |
| 1210 / 3225 | 2.80 | 1.20 | 2.10 |
| 1812 / 4532 | 3.60 | 1.50 | 3.00 |
| 2220 / 5750 | 5.50 | 1.50 | 4.20 |

2-fold MCV array



Dimensions in mm

| Case size EIA / mm | A | B | C | D | E |
|-----------------------|------|------|------|------|------|
| 0508 / 1220 | 1.00 | 1.30 | 0.40 | 0.60 | 2.16 |

Multilayer varistors (MLVs)
Automotive E series
SMD
Delivery mode

| EIA case size | Taping | Reel size mm | Packing unit pcs. | Type | Ordering code |
|--------------------|-----------|--------------|-------------------|------------------|-----------------|
| Array | | | | | |
| 0508 | Cardboard | 180 | 4000 | CA05M2S10T100HG | B72812Q1120S160 |
| Single chip | | | | | |
| 0402 | Cardboard | 180 | 10000 | CT0402L14G | B72590E0140L060 |
| 0402 | Cardboard | 180 | 10000 | CT0402S17AG | B72590E0170S160 |
| 0402 | Cardboard | 180 | 10000 | CT0402S20AHSG_P | B72590P8200S060 |
| 0603 | Cardboard | 180 | 4000 | CT0603K14G | B72500E0140K060 |
| 0603 | Cardboard | 180 | 4000 | CT0603K17G | B72500E0170K060 |
| 0603 | Cardboard | 180 | 4000 | CT0603K17LCG | B72500E2170K060 |
| 0603 | Cardboard | 180 | 4000 | CT0603K20G | B72500E0200K060 |
| 0603 | Cardboard | 180 | 4000 | CT0603K25G | B72500E0250K060 |
| 0603 | Cardboard | 180 | 4000 | CT0603L25HSG | B72500E8250L060 |
| 0603 | Cardboard | 180 | 4000 | CT0603L25HTCCG | B72500E5250L060 |
| 0603 | Cardboard | 180 | 4000 | CT0603S14AHSG | B72500E8140S160 |
| 0603 | Cardboard | 180 | 4000 | CT0603S14BAUTOG | B72500E1140S260 |
| 0603 | Cardboard | 180 | 4000 | CT0603S14BG | B72500E0140S260 |
| 0603 | Cardboard | 180 | 4000 | CT0603S17ALCG | B72500E2170S160 |
| 0603 | Cardboard | 180 | 4000 | CT0603S17BCCG | B72500E5170S260 |
| 0603 | Cardboard | 180 | 4000 | CT0603S20ACCG | B72500E5200S160 |
| 0603 | Cardboard | 180 | 4000 | CT0603S20AHSG_P | B72500P8200S060 |
| 0603 | Cardboard | 180 | 4000 | CT0603V150RFG | B72500E7151V060 |
| 0805 | Blister | 180 | 3000 | CT0805K11G | B72510E0110K062 |
| 0805 | Blister | 180 | 3000 | CT0805K14G | B72510E0140K062 |
| 0805 | Blister | 180 | 3000 | CT0805K17AUTOLCG | B72510E2170K062 |
| 0805 | Blister | 180 | 3000 | CT0805K17G | B72510E0170K062 |
| 0805 | Blister | 180 | 3000 | CT0805K20G | B72510E0200K062 |
| 0805 | Blister | 180 | 3000 | CT0805K25AUTOG | B72510E1250K062 |
| 0805 | Blister | 180 | 3000 | CT0805K25G | B72510E0250K062 |
| 0805 | Blister | 180 | 3000 | CT0805K30G | B72510E0300K062 |
| 0805 | Blister | 180 | 3000 | CT0805K35G | B72510E0350K062 |
| 0805 | Blister | 180 | 3000 | CT0805S14BAUTOG | B72510E1140S262 |
| 0805 | Blister | 330 | 12000 | CT0805S20ACC2G2 | B72510E9200S172 |
| 1206 | Blister | 180 | 2000 | CT1206K25AUTOG | B72520E1250K062 |
| 1206 | Blister | 180 | 2000 | CT1206K25G | B72520E0250K062 |
| 1206 | Blister | 180 | 2000 | CT1206K30G | B72520E0300K062 |
| 1206 | Blister | 180 | 2000 | CT1206K35G | B72520E0350K062 |
| 1206 | Blister | 180 | 2000 | CT1206K40G | B72520E0400K062 |
| 1206 | Blister | 180 | 3000 | CT1206K14G | B72520E0140K062 |
| 1206 | Blister | 180 | 3000 | CT1206K17G | B72520E0170K062 |
| 1206 | Blister | 180 | 3000 | CT1206K20AUTOG | B72520E1200K062 |
| 1206 | Blister | 180 | 3000 | CT1206K20G | B72520E0200K062 |
| 1206 | Blister | 180 | 3000 | CT1206S14BAUTOG | B72520E1140S262 |

Multilayer varistors (MLVs)
Automotive E series
SMD

| EIA case size | Taping | Reel size mm | Packing unit pcs. | Type | Ordering code |
|---------------|---------|--------------|-------------------|--------------------|-----------------|
| 1210 | Blister | 180 | 2000 | CT1210K20AUTOG | B72530E1200K062 |
| 1210 | Blister | 180 | 2000 | CT1210K20G | B72530E0200K062 |
| 1210 | Blister | 180 | 2000 | CT1210K25AUTOG | B72530E1250K062 |
| 1210 | Blister | 180 | 2000 | CT1210K25G | B72530E0250K062 |
| 1210 | Blister | 180 | 2000 | CT1210K30G | B72530E0300K062 |
| 1210 | Blister | 180 | 2000 | CT1210K35G | B72530E0350K062 |
| 1210 | Blister | 180 | 3000 | CT1210K14G | B72530E0140K062 |
| 1210 | Blister | 180 | 3000 | CT1210K17AUTOG | B72530E1170K062 |
| 1210 | Blister | 180 | 3000 | CT1210K17G | B72530E0170K062 |
| 1210 | Blister | 180 | 3000 | CT1210S14BAUTOG | B72530E1140S262 |
| 1812 | Blister | 180 | 1000 | CT1812K25G | B72580E0250K062 |
| 1812 | Blister | 180 | 1000 | CT1812K30G | B72580E0300K062 |
| 1812 | Blister | 180 | 1000 | CT1812K35G | B72580E0350K062 |
| 1812 | Blister | 180 | 1500 | CT1812K14G | B72580E0140K062 |
| 1812 | Blister | 180 | 1500 | CT1812K17G | B72580E0170K062 |
| 1812 | Blister | 180 | 1500 | CT1812K20G | B72580E0200K062 |
| 1812 | Blister | 180 | 1500 | CT1812S14BAUTOG | B72580E1140S262 |
| 1812 | Blister | 330 | 3000 | CT1812S14BAUTOE2G2 | B72580E3140S272 |
| 2220 | Blister | 180 | 1000 | CT2220K25G | B72540E0250K062 |
| 2220 | Blister | 180 | 1000 | CT2220K30AUTOG | B72540E1300K062 |
| 2220 | Blister | 180 | 1000 | CT2220K30G | B72540E0300K062 |
| 2220 | Blister | 180 | 1000 | CT2220K35G | B72540E0350K062 |
| 2220 | Blister | 180 | 1000 | CT2220K40G | B72540E0400K062 |
| 2220 | Blister | 180 | 1500 | CT2220K14G | B72540E0140K062 |
| 2220 | Blister | 180 | 1500 | CT2220K17G | B72540E0170K062 |
| 2220 | Blister | 180 | 1500 | CT2220K20G | B72540E0200K062 |
| 2220 | Blister | 180 | 1500 | CT2220S14BAUTOG | B72540E1140S262 |
| 2220 | Blister | 330 | 3000 | CT2220K30AUTOE2G2 | B72540E3300K072 |
| 2220 | Blister | 330 | 3000 | CT2220S14BAUTOE2G2 | B72540E3140S272 |

Multilayer varistors (MLVs)

Automotive E series

SMD

V/I characteristics for automotive standard series



CT0402L14G



CT0402S17AG

Multilayer varistors (MLVs)

Automotive E series

SMD

V/I characteristics for automotive standard series



CT0402S20AHSG_P



CT0603K14G

Multilayer varistors (MLVs)

Automotive E series

SMD

V/I characteristics for automotive standard series



CT0603S14AHSG



CT0603S14BG

Multilayer varistors (MLVs)

Automotive E series

SMD

V/I characteristics for automotive standard series



CT0603K17G



CT0603K17LCG

Multilayer varistors (MLVs)

Automotive E series

SMD

V/I characteristics for automotive standard series



CT0603S17ALCG
CT0603S17BCCG



CT0603K20G

Multilayer varistors (MLVs)

Automotive E series

SMD

V/I characteristics for automotive standard series



CT0603S20ACCG

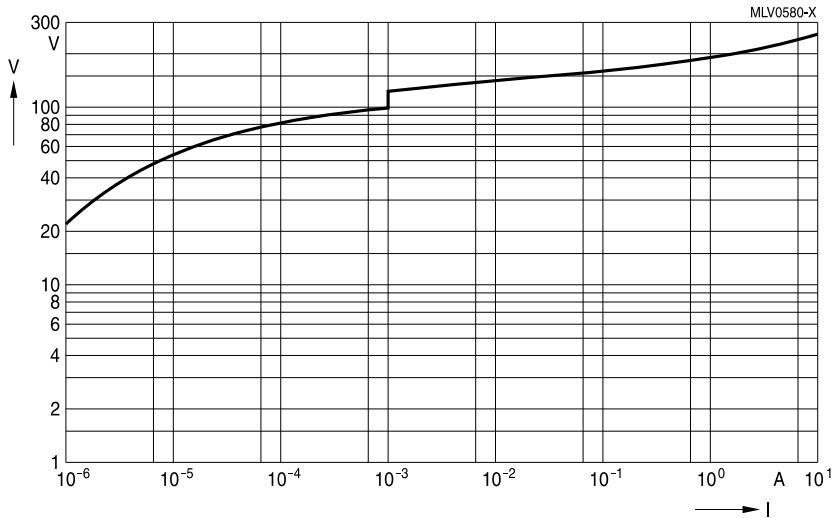

CT0603S20AHSG_P

Multilayer varistors (MLVs)

Automotive E series

SMD

V/I characteristics for automotive standard series



CT0603K25G

Multilayer varistors (MLVs)

Automotive E series

SMD

V/I characteristics for automotive standard series

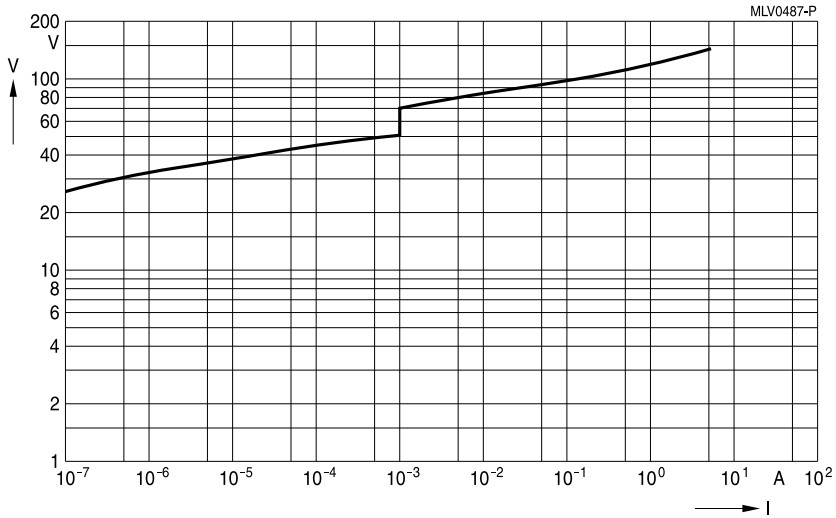

CT0603L25HSG
CT0603L25HTCCG

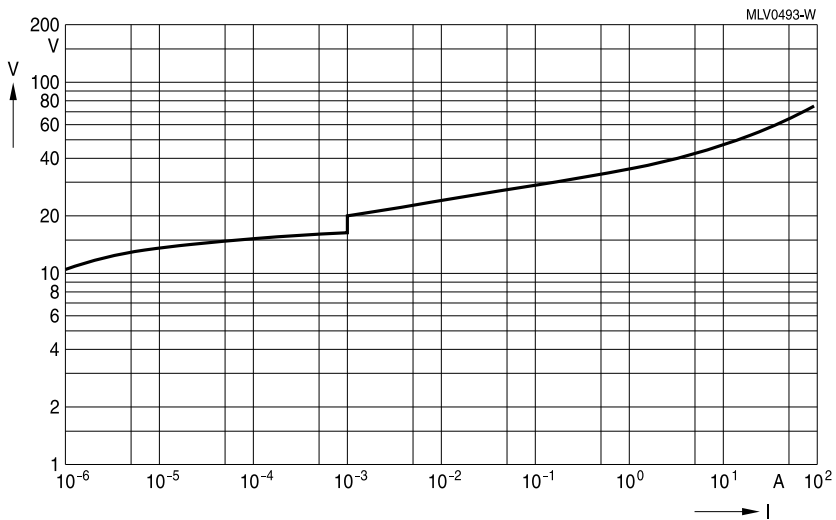

CT0805K11G

Multilayer varistors (MLVs)

Automotive E series

SMD

V/I characteristics for automotive standard series



CT0805K14G



CT0805K17G

Multilayer varistors (MLVs)

Automotive E series

SMD

V/I characteristics for automotive standard series



CT0805K20G



CT0805S20ACC2G2

Multilayer varistors (MLVs)

Automotive E series

SMD

V/I characteristics for automotive standard series



CT0805K25G



CT0805K30G

Multilayer varistors (MLVs)

Automotive E series

SMD

V/I characteristics for automotive standard series



CT0805K35G



CT1206K14G

Multilayer varistors (MLVs)

Automotive E series

SMD

V/I characteristics for automotive standard series



CT1206K17G

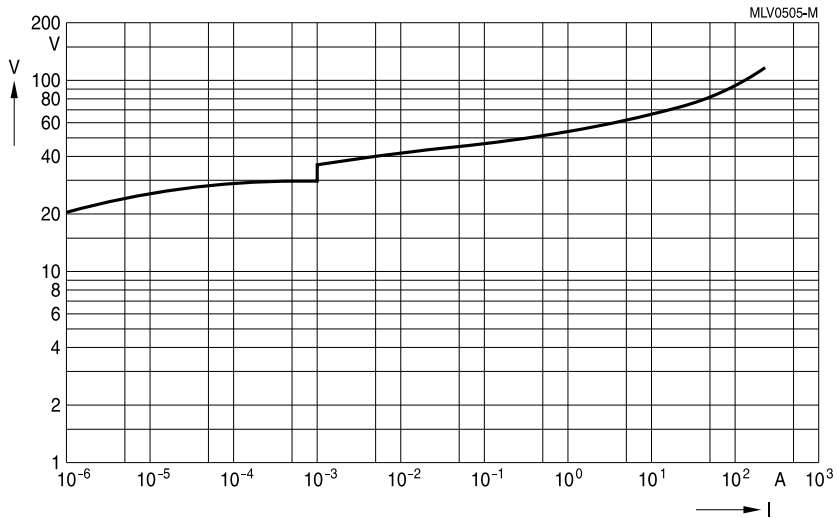

CT1206K20G

Multilayer varistors (MLVs)

Automotive E series

SMD

V/I characteristics for automotive standard series

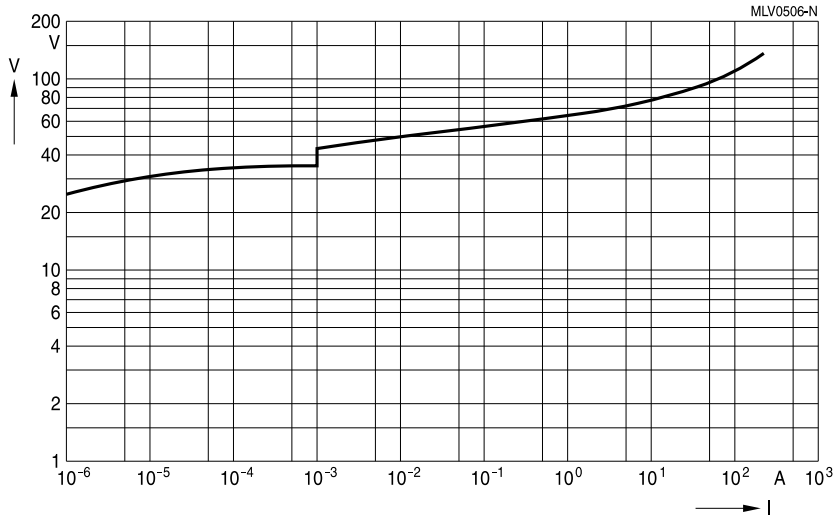

CT1206K25G



CT1206K30G

Multilayer varistors (MLVs)

Automotive E series

SMD

V/I characteristics for automotive standard series



CT1206K35G



CT1206K40G

Multilayer varistors (MLVs)

Automotive E series

SMD

V/I characteristics for automotive standard series



CT1210K14G



CT1210K17G

Multilayer varistors (MLVs)

Automotive E series

SMD

V/I characteristics for automotive standard series



CT1210K20G

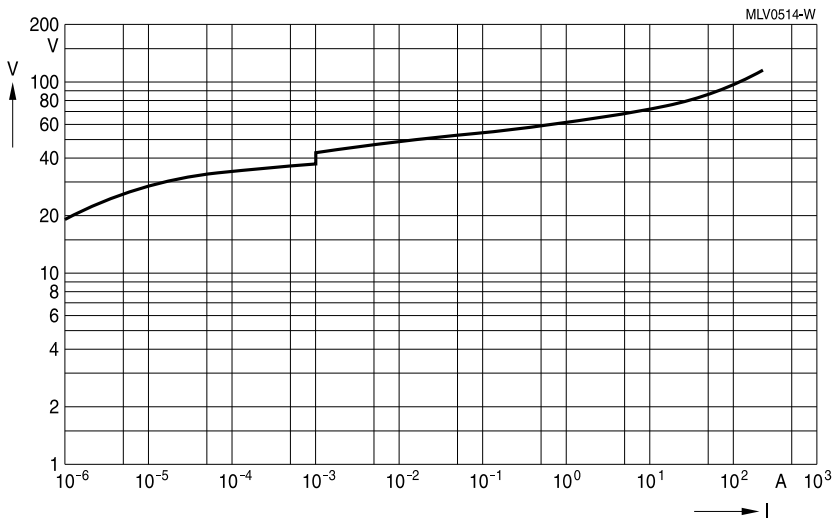

CT1210K25G

Multilayer varistors (MLVs)

Automotive E series

SMD

V/I characteristics for automotive standard series



CT1210K30G



CT1210K35G

Multilayer varistors (MLVs)

Automotive E series

SMD

V/I characteristics for automotive standard series



CT1812K14G



CT1812K17G

Multilayer varistors (MLVs)

Automotive E series

SMD

V/I characteristics for automotive standard series



CT1812K20G



CT1812K25G

Multilayer varistors (MLVs)

Automotive E series

SMD

V/I characteristics for automotive standard series



CT1812K30G



CT1812K35G

Multilayer varistors (MLVs)

Automotive E series

SMD

V/I characteristics for automotive standard series



CT2220K14G



CT2220K17G

Multilayer varistors (MLVs)

Automotive E series

SMD

V/I characteristics for automotive standard series



CT2220K20G

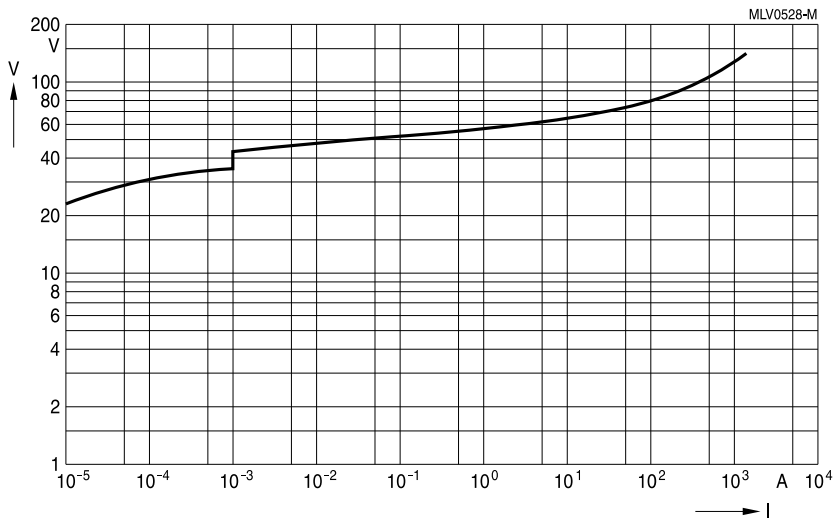

CT2220K25G

Multilayer varistors (MLVs)

Automotive E series

SMD

V/I characteristics for automotive standard series



CT2220K30G



CT2220K35G

Multilayer varistors (MLVs)

Automotive E series

SMD

V/I characteristics for automotive standard series



CT2220K40G

Multilayer varistors (MLVs)

Automotive E series

SMD

V/I characteristics for automotive series with load dump/ jump-start protection



CT0603S14BAUTOG



CT0805S14BAUTOG

Multilayer varistors (MLVs)

Automotive E series

SMD

V/I characteristics for automotive series with load dump/ jump-start protection



CT0805K17AUTOLCG



CT0805K25AUTOG

Multilayer varistors (MLVs)

Automotive E series

SMD

V/I characteristics for automotive series with load dump/ jump-start protection



CT1206S14BAUTOG



CT1206K20AUTOG

Multilayer varistors (MLVs)

Automotive E series

SMD

V/I characteristics for automotive series with load dump/ jump-start protection

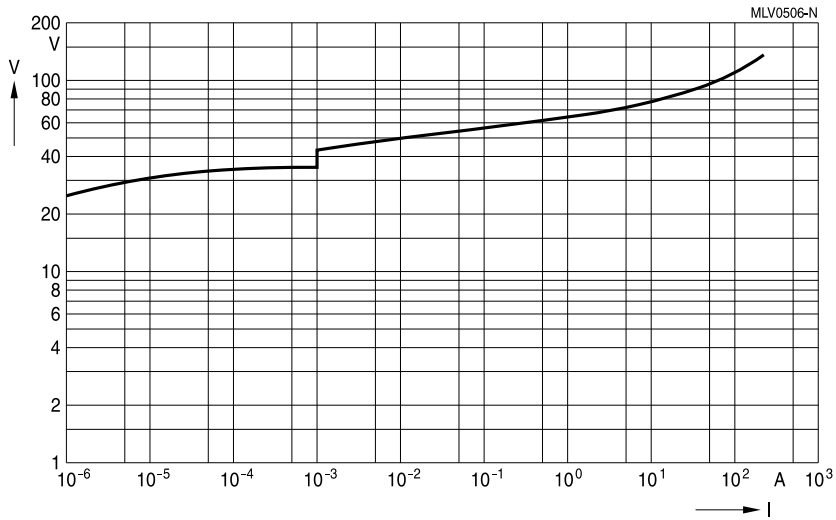

CT1206K25AUTOG

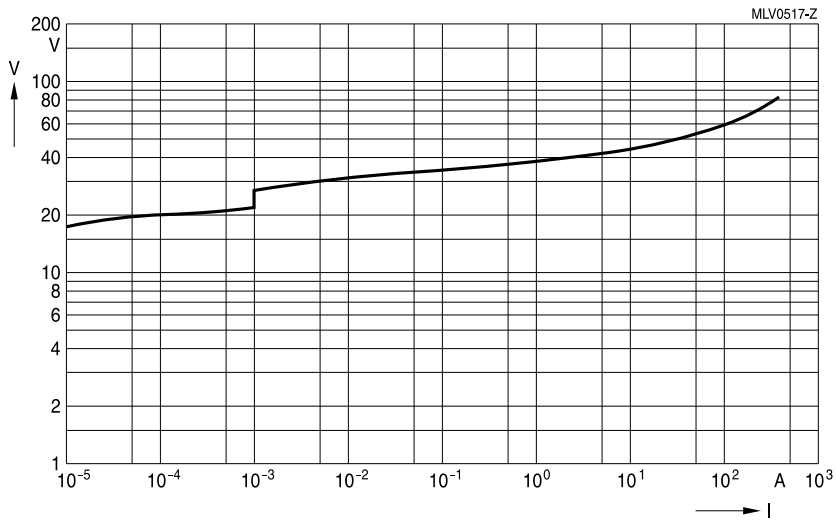

CT1210S14BAUTOG

Multilayer varistors (MLVs)

Automotive E series

SMD

V/I characteristics for automotive series with load dump/ jump-start protection



CT1210K17AUTOG



CT1210K20AUTOG

Multilayer varistors (MLVs)

Automotive E series

SMD

V/I characteristics for automotive series with load dump/ jump-start protection



CT1210K25AUTOG



CT1812S14BAUTOE2G2

CT1812S14BAUTOG

Multilayer varistors (MLVs)

Automotive E series

SMD

V/I characteristics for automotive series with load dump/ jump-start protection



CT2220S14BAUTOE2G2



CT2220S14BAUTOG

Multilayer varistors (MLVs)

Automotive E series

SMD

V/I characteristics for automotive series with load dump/ jump-start protection



CT2220K30AUTOE2G2



CT2220K30AUTOG

Multilayer varistors (MLVs)

Automotive E series

SMD

V/I characteristics for automotive series, array

(Derating curve is not specified for CA05M2S10T100HG)

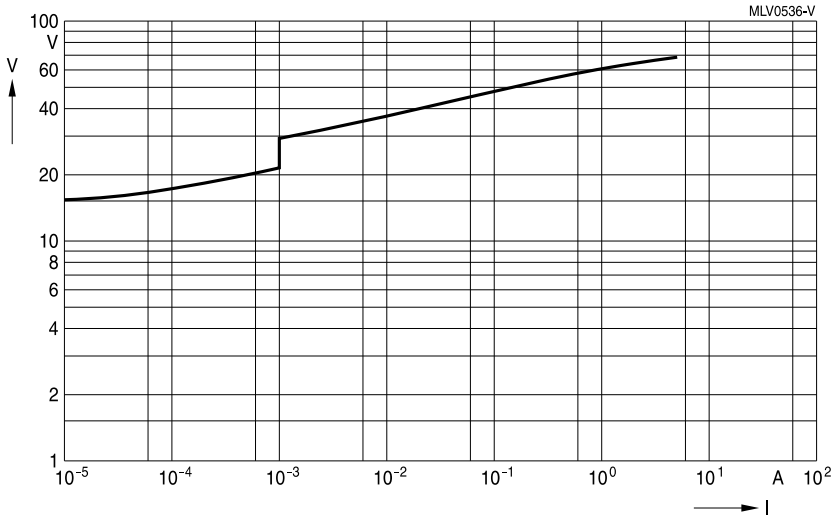

CA05M2S10T100HG, MCV array

Multilayer varistors (MLVs)

Automotive E series

SMD

Derating curves for automotive standard series

Maximum surge current $I_{\text{surge,max}} = f(t_r, \text{pulse train})$

For explanation of the derating curves refer to "General technical information", chapter 2.7.1



CT0402L14G



CT0402S17AG

Multilayer varistors (MLVs)

Automotive E series

SMD

Derating curves for automotive standard series

Maximum surge current $I_{\text{surge,max}} = f(t_r, \text{pulse train})$

For explanation of the derating curves refer to "General technical information", chapter 2.7.1



CT0603K14G ... K25G
CT0603S17ALCG

CT0603K17LCG
CT0603S17BCCG

CT0603S14BG
CT0603S20ACCG



CT0603L25HTCCG

CT0603S14AHSG

CT0603L25HSG

Multilayer varistors (MLVs)

Automotive E series

SMD

Derating curves for automotive standard series

Maximum surge current $I_{\text{surge,max}} = f(t_r, \text{pulse train})$

For explanation of the derating curves refer to "General technical information", chapter 2.7.1



CT0805K11G ... K17G



CT0805K20G ... K35G

CT0805S20ACC2G2

Multilayer varistors (MLVs)

Automotive E series

SMD

Derating curves for automotive standard series

Maximum surge current $I_{\text{surge,max}} = f(t_r, \text{pulse train})$

For explanation of the derating curves refer to "General technical information", chapter 2.7.1



CT1206K14G ... K30G



CT1206K35G ... K40G

Multilayer varistors (MLVs)

Automotive E series

SMD

Derating curves for automotive standard series

Maximum surge current $I_{\text{surge,max}} = f(t_r, \text{pulse train})$

For explanation of the derating curves refer to "General technical information", chapter 2.7.1



CT1210K14G ... K20G



CT1210K25G ... K30G

Multilayer varistors (MLVs)

Automotive E series

SMD

Derating curves for automotive standard series

Maximum surge current $I_{\text{surge,max}} = f(t_r, \text{pulse train})$

For explanation of the derating curves refer to "General technical information", chapter 2.7.1



CT1210K35G



CT1812K14G ... K30G

Multilayer varistors (MLVs)

Automotive E series

SMD

Derating curves for automotive standard series

Maximum surge current $I_{\text{surge,max}} = f(t_r, \text{pulse train})$

For explanation of the derating curves refer to "General technical information", chapter 2.7.1



CT1812K35G



CT2220K14G ... K30G

Multilayer varistors (MLVs)

Automotive E series

SMD

Derating curves for automotive standard series

Maximum surge current $I_{\text{surge,max}} = f(t_r, \text{pulse train})$

For explanation of the derating curves refer to "General technical information", chapter 2.7.1



CT2220K35G ... K40G

Multilayer varistors (MLVs)

Automotive E series

SMD

Derating curves for automotive series with load dump/ jump-start protection

Maximum surge current $I_{\text{surge,max}} = f(t_r, \text{pulse train})$

For explanation of the derating curves refer to "General technical information", chapter 2.7.1



CT0603S14BAUTOG



CT0805K17AUTOLCG

CT0805K25AUTOG

Multilayer varistors (MLVs)

Automotive E series

SMD

Derating curves for automotive series with load dump/ jump-start protection

Maximum surge current $I_{\text{surge,max}} = f(t_r, \text{pulse train})$

For explanation of the derating curves refer to "General technical information", chapter 2.7.1



CT0805S14BAUTOG



CT1206K20AUTOG

CT1206K25AUTOG

CT1206S14BAUTOG

Multilayer varistors (MLVs)

Automotive E series

SMD

Derating curves for automotive series with load dump/ jump-start protection

Maximum surge current $I_{\text{surge,max}} = f(t_r, \text{pulse train})$

For explanation of the derating curves refer to "General technical information", chapter 2.7.1



CT1210K17AUTOG

CT1210K20AUTOG

CT1210S14BAUTOG



CT1210K25AUTOG

Multilayer varistors (MLVs)

Automotive E series

SMD

Derating curves for automotive series with load dump/ jump-start protection

Maximum surge current $I_{\text{surge,max}} = f(t_r, \text{pulse train})$

For explanation of the derating curves refer to "General technical information", chapter 2.7.1



CT1812S14BAUTOE2G2

CT1812S14BAUTOG

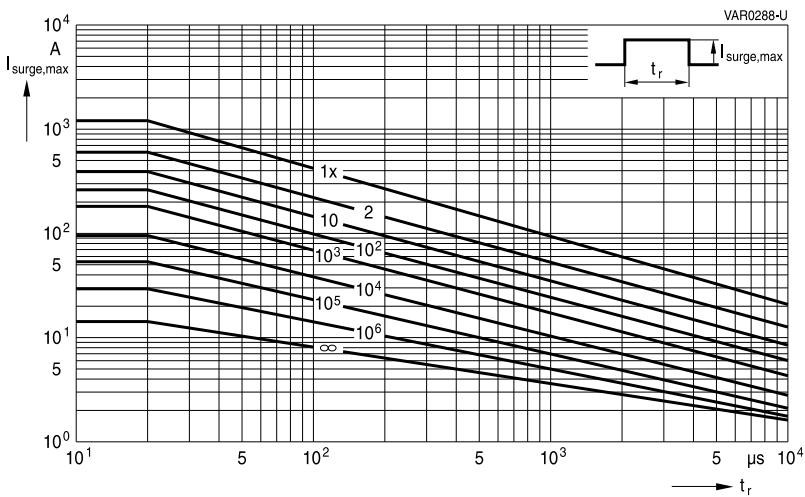

CT2220K30AUTOE2G2

CT2220S14BAUTOE2G2

CT2220K30AUTOG

CT2220S14BAUTOG

Multilayer varistors (MLVs)

Automotive E series

SMD

Taping and packing

1 Taping and packing for SMD components

1.1 Blister tape (taping to IEC 60286-3)



KKE0053-C-E

Dimensions in mm

| | 8-mm tape | | | | | 12-mm tape | | Tolerance |
|----------------|---------------------|---------------|---------------|---------------|---------------|---------------------|---------------|---------------------|
| | Case size (inch/mm) | | | | | Case size (inch/mm) | | |
| | | | 0508/ 1220 | 0612/ 1632 | 1012/ 2532 | | | |
| | 0603/ 1608 | 0506/ 1216 | 0805/ 2012 | 1206/ 3216 | 1210/ 3225 | 1812/ 4532 | 2220/ 5750 | |
| A ₀ | 0.9 ±0.10 | 1.50 | 1.50 | 1.80 | 2.80 | 3.50 | 5.10 | ±0.20 |
| B ₀ | 1.75 ±0.10 | 1.80 | 2.30 | 3.40 | 3.50 | 4.80 | 6.00 | ±0.20 |
| K ₀ | 1.0 | 0.80 | 1.80 | | | 3.40 | | max. |
| T | 0.30 | | | | | 0.30 | | max. |
| T ₂ | 1.3 | 1.20 | 2.50 | | | 3.90 | | max. |
| D ₀ | 1.50 | | | | | 1.50 | | +0.10/-0 |
| D ₁ | 0.3 | | | | | 1.50 | | min. |
| P ₀ | 4.00 | | | | | 4.00 | | ±0.10 ¹⁾ |
| P ₂ | 2.00 | | | | | 2.00 | | ±0.05 |
| P ₁ | 4.00 | | | | | 8.00 | | ±0.10 |
| W | 8.00 | | | | | 12.00 | | ±0.30 |
| E | 1.75 | | | | | 1.75 | | ±0.10 |
| F | 3.50 | | | | | 5.50 | | ±0.05 |
| G | 0.75 | | | | | 0.75 | | min. |

1) ≤±0.2 mm over 10 sprocket holes.

Multilayer varistors (MLVs)

Automotive E series

SMD

Part orientation in tape pocket for blister tape

For discrete chip, EIA case sizes 0603, 0805, 1206, 1210, 1812 and 2220



For array, EIA case size 0612



For arrays, EIA case sizes 0506 and 1012



For filter array, EIA case size 0508



Additional taping information

| | |
|---------------------------|---|
| Reel material | Polystyrol (PS) |
| Tape material | Polystyrol (PS) or Polycarbonat (PC) or PVC |
| Tape break force | min. 10 N |
| Top cover tape strength | min. 10 N |
| Top cover tape peel force | 0.1 to 1.0 N for 8-mm tape and 0.1 to 1.3 N for 12-mm tape at a peel speed of 300 mm/min |
| Tape peel angle | Angle between top cover tape and the direction of feed during peel off: 165° to 180° |
| Cavity play | Each part rests in the cavity so that the angle between the part and cavity center line is no more than 20° |

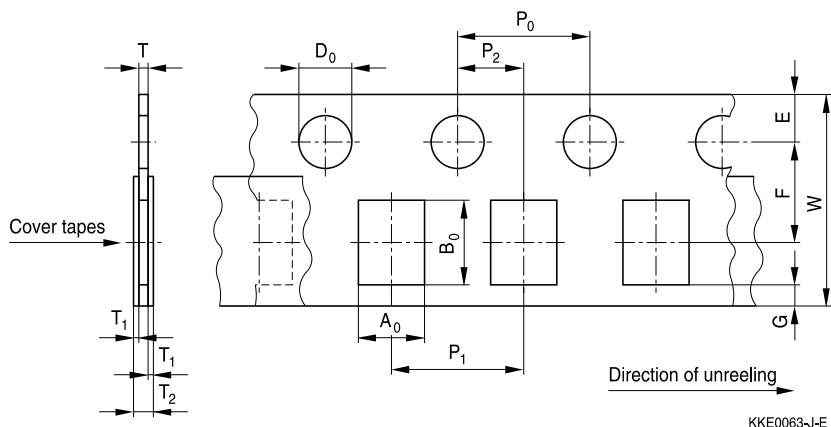
Multilayer varistors (MLVs)
Automotive E series
SMD
1.2 Cardboard tape (taping to IEC 60286-3)

Dimensions in mm

| | 8-mm tape | | | | | | Tolerance |
|----------------|---------------------|-----------|-----------|-----------|-----------|---------------------|---------------------|
| | Case size (inch/mm) | | | | | Case size (inch/mm) | |
| | 0201/0603 | 0402/1005 | 0405/1012 | 0603/1608 | 1003/2508 | 0508/1220 | |
| A ₀ | 0.38 ±0.05 | 0.60 | 1.05 | 0.95 | 1.00 | 1.60 | ±0.20 |
| B ₀ | 0.68 ±0.05 | 1.15 | 1.60 | 1.80 | 2.85 | 2.40 | ±0.20 |
| T | 0.42 ±0.02 | 0.60 | 0.75 | 0.95 | 0.95 | 0.95 | max. |
| T ₂ | 0.4 min. | 0.70 | 0.90 | 1.10 | 1.10 | 1.10 | max. |
| D ₀ | 1.50 ±0.1 | 1.50 | | | | 1.50 | +0.10/-0 |
| P ₀ | 4.00 | | | | | | ±0.10 ²⁾ |
| P ₂ | 2.00 | | | | | | ±0.05 |
| P ₁ | 2.00 ±0.05 | 2.00 | 4.00 | 4.00 | 4.00 | 4.00 | ±0.10 |
| W | 8.00 | | | | | | ±0.30 |
| E | 1.75 | | | | | | ±0.10 |
| F | 3.50 | | | | | | ±0.05 |
| G | 0.75 | | | | | | min. |

2) ≤0.2 mm over 10 sprocket holes.

Multilayer varistors (MLVs)

Automotive E series

SMD

Part orientation in tape pocket for cardboard tape

For discrete chip, EIA case sizes 0201, 0402, 0603 and 1003

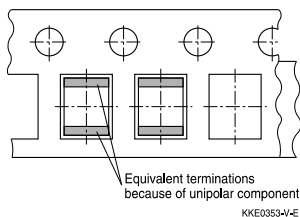

For array, EIA case size 0405

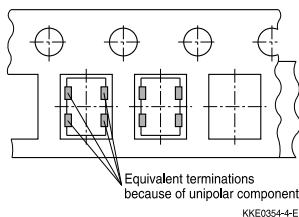

For array, EIA case size 0508



For filter array, EIA case size 0405

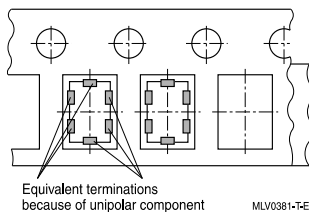

Additional taping information

| | |
|---------------------------|---|
| Reel material | Polystyrol (PS) |
| Tape material | Cardboard |
| Tape break force | min. 10 N |
| Top cover tape strength | min. 10 N |
| Top cover tape peel force | 0.1 to 1.0 N at a peel speed of 300 mm/min |
| Tape peel angle | Angle between top cover tape and the direction of feed during peel off: 165° to 180° |
| Cavity play | Each part rests in the cavity so that the angle between the part and cavity center line is no more than 20° |

Multilayer varistors (MLVs)

Automotive E series

SMD

1.3 Reel packing



Dimensions in mm

| | 8-mm tape | | 12-mm tape | |
|----------------|-------------|-------------|--------------|--------------|
| | 180-mm reel | 330-mm reel | 180-mm reel | 330-mm reel |
| A | 180 +0/-3 | 330 +0/-2.0 | 180 +0/-3 | 330 +0/-2.0 |
| W ₁ | 8.4 +1.5/-0 | 8.4 +1.5/-0 | 12.4 +1.5/-0 | 12.4 +1.5/-0 |
| W ₂ | 14.4 max. | 14.4 max. | 18.4 max. | 18.4 max. |

Leader, trailer

Trailer (tape end)

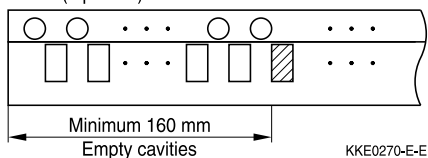

Leader



Multilayer varistors (MLVs)
Automotive E series
SMD
1.4 Packing units for discrete chip and array chip

| Case size inch/mm |  Chip thickness th |  | |  Ø 180-mm reel |  Ø 330-mm reel |
|----------------------|---|---|-------------------|--|---|
| | | Cardboard tape W | Blister tape W | pcs. | pcs. |
| 0201/0603 | 0.33 mm | 8 mm | – | 15000 | – |
| 0402/1005 | 0.6 mm | 8 mm | – | 10000 | 50000 |
| 0405/1012 | 0.7 mm | 8 mm | – | 5000 | – |
| 0506/1216 | 0.5 mm | – | 8 mm | 4000 | – |
| 0508/1220 | 0.9 mm | 8 mm | 8 mm | 4000 | – |
| 0603/1608 | 0.9 mm | 8 mm | 8 mm | 4000 | 16000 |
| 0612/1632 | 0.7 mm | – | 8 mm | 3000 | – |
| 0805/2012 | 0.7 mm | – | 8 mm | 3000 | – |
| | 0.9 mm | – | 8 mm | 3000 | 12000 |
| | 1.3 mm | – | 8 mm | 3000 | 12000 |
| 1003/2508 | 0.9 mm | 8 mm | – | 4000 | – |
| 1012/2532 | 1.0 mm | – | 8 mm | 2000 | – |
| 1206/3216 | 0.9 mm | – | 8 mm | 3000 | – |
| | 1.3 mm | – | 8 mm | 3000 | 12000 |
| | 1.4 mm | – | 8 mm | 2000 | 8000 |
| | 1.6 mm | – | 8 mm | 2000 | 8000 |
| 1210/3225 | 0.9 mm | – | 8 mm | 3000 | – |
| | 1.3 mm | – | 8 mm | 3000 | 12000 |
| | 1.4 mm | – | 8 mm | 2000 | 8000 |
| | 1.6 mm | – | 8 mm | 2000 | 8000 |
| 1812/4532 | 1.3 mm | – | 12 mm | 1500 | – |
| | 1.4 mm | – | 12 mm | 1000 | – |
| | 1.6 mm | – | 12 mm | 1000 | 4000 |
| | 2.0 mm | – | 12 mm | – | 3000 |
| | 2.3 mm | – | 12 mm | – | 3000 |
| 2220/5750 | 1.3 mm | – | 12 mm | 1500 | – |
| | 1.4 mm | – | 12 mm | 1000 | – |
| | 1.6 mm | – | 12 mm | 1000 | – |
| | 2.0 mm | – | 12 mm | – | 3000 |
| | 2.3 mm | – | 12 mm | – | 3000 |
| | 2.7 mm | – | 12 mm | 600 | – |
| | 3.0 mm | – | 12 mm | 600 | – |

Multilayer varistors (MLVs)**Automotive E series****SMD****2 Delivery mode for leaded SHCV varistors**

Standard delivery mode for SHCV types is bulk. Alternative taping modes (AMMO pack or taped on reel) are available upon request.

Packing units for:

| Type | Pieces |
|-----------|--------|
| SR6 | 2000 |
| SR1 / SR2 | 1000 |

For types not listed in this data book please contact EPCOS.

Multilayer varistors (MLVs)

Automotive E series

SMD

Soldering directions

1 Terminations and soldering methods

1.1 Nickel barrier termination

The nickel barrier layer of the silver/nickel/tin termination prevents leaching of the silver base metallization layer. This allows great flexibility in the selection of soldering parameters. The tin prevents the nickel layer from oxidizing and thus ensures better wetting by the solder. The nickel barrier termination is suitable for lead-free soldering, as well as for other commonly-used soldering methods.

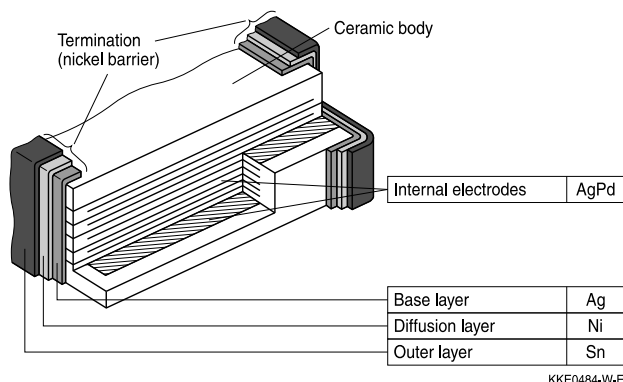

Multilayer CTVS: Structure of nickel barrier termination

1.2 Silver-platinum termination

Silver-platinum terminations are mainly used for the large EIA case sizes 1812 and 2220. The silver-platinum termination is approved for reflow soldering, SnPb soldering and lead-free soldering with a silver containing solder paste. In case of SnPb soldering, a solder paste Sn62Pb36Ag2 is recommended. For lead-free reflow soldering, a solder paste SAC, e.g. Sn95.5Ag3.8Cu0.7, is recommended.



Multilayer varistor: Structure of silver-platinum termination

Multilayer varistors (MLVs)

Automotive E series

SMD

1.3 Silver-palladium termination

Silver-palladium terminations are designed for the use of conductive adhesives. Lead-free reflow soldering does not form a proper solder joint. In general reflow or wave soldering is not recommended.

1.4 Tinned iron wire

All SHCV types with tinned terminations are suitable for lead-free and SnPb soldering.

Multilayer varistors (MLVs)

Automotive E series

SMD

2 Recommended soldering temperature profiles

2.1 Reflow soldering temperature profile

Temperature ranges for reflow soldering acc. to IEC 60068-2-58 recommendations.



| Profile feature | | Sn-Pb eutectic assembly | Pb-free assembly |
|--------------------------------|--------------------------|---------------------------------|-------------------|
| Preheat and soak | | | |
| - Temperature min | T_{smin} | 100 °C | 150 °C |
| - Temperature max | T_{smax} | 150 °C | 200 °C |
| - Time | t_{smin} to t_{smax} | 60 ... 120 s | 60 ... 120 s |
| Average ramp-up rate | T_{smax} to T_p | 3 °C/ s max. | 3 °C/ s max. |
| Liquidous temperature | T_L | 183 °C | 217 °C |
| Time at liquidous | t_L | 40 ... 150 s | 40 ... 150 s |
| Peak package body temperature | T_p | 215 °C ... 260 °C ¹⁾ | 235 °C ... 260 °C |
| Time above ($T_p - 5$ °C) | t_p | 10 ... 40 s | 10 ... 40 s |
| Average ramp-down rate | T_p to T_{smax} | 6 °C/ s max. | 6 °C/ s max. |
| Time 25 °C to peak temperature | | max. 8 minutes | max. 8 minutes |

1) Depending on package thickness.

Notes: All temperatures refer to topside of the package, measured on the package body surface.

Number of reflow cycles: 3

Iron soldering should be avoided, hot air methods are recommended for repair purposes.

Multilayer varistors (MLVs)

Automotive E series

SMD

2.2 Wave soldering temperature profile

Temperature characteristics at component terminal with dual-wave soldering

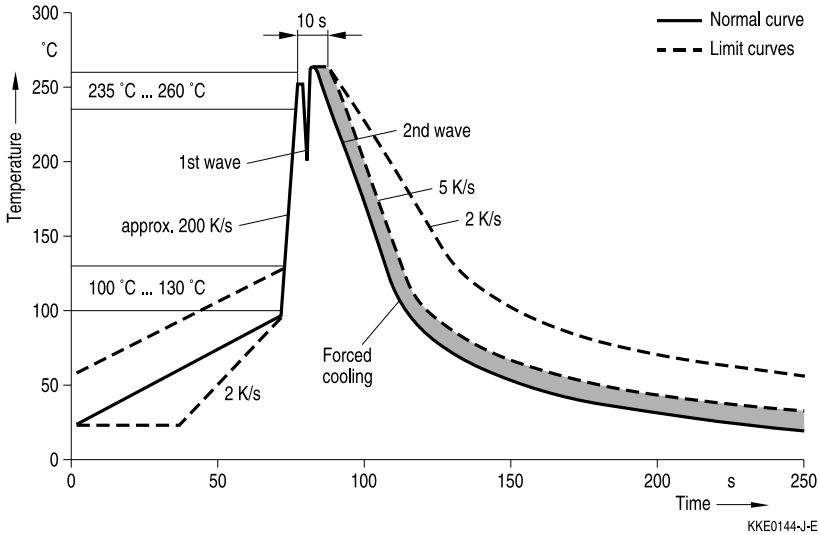

3 Solder joint profiles / solder quantity

3.1 Nickel barrier termination

If the meniscus height is too low, that means the solder quantity is too low, the solder joint may break, i.e. the component becomes detached from the joint. This problem is sometimes interpreted as leaching of the external terminations.

If the solder meniscus is too high, i.e. the solder quantity is too large, the vise effect may occur. As the solder cools down, the solder contracts in the direction of the component. If there is too much solder on the component, it has no leeway to evade the stress and may break, as in a vise.

The figures below show good and poor solder joints for dual-wave and infrared soldering.

Multilayer varistors (MLVs)

Automotive E series

SMD

3.1.1 Solder joint profiles for nickel barrier termination - dual-wave soldering

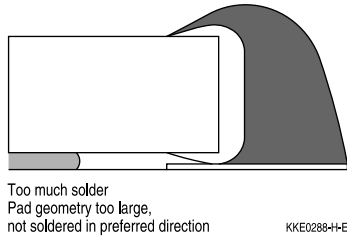

Good and poor solder joints caused by amount of solder in dual-wave soldering.

3.1.2 Solder joint profiles for nickel barrier termination / silver-platinum termination - reflow soldering

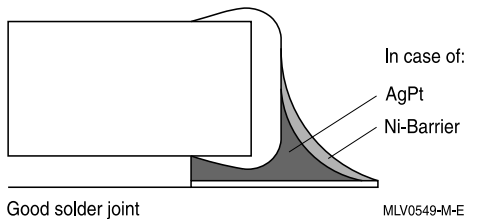
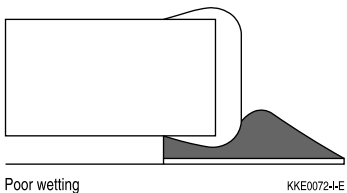
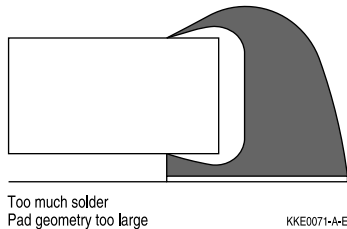
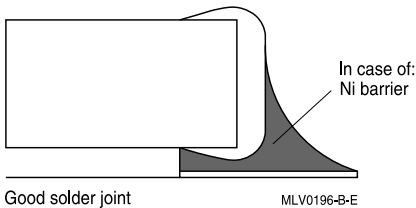

Good and poor solder joints caused by amount of solder in reflow soldering.

Multilayer varistors (MLVs)
Automotive E series
SMD
4 Solderability tests

| Test | Standard | Test conditions Sn-Pb soldering | Test conditions Pb-free soldering | Criteria/ test results |
|---|-------------------|--|---|---|
| Wettability | IEC 60068-2-58 | Immersion in 60/40 SnPb solder using non-activated flux at 215 ±3 °C for 3 ±0.3 s | Immersion in Sn96.5Ag3.0Cu0.5 solder using non- or low activated flux at 245 ±5 °C for 3 ±0.3 s | Covering of 95% of end termination, checked by visual inspection |
| Leaching resistance | IEC 60068-2-58 | Immersion in 60/40 SnPb solder using mildly activated flux without preheating at 260 ±5 °C for 10 ±1 s | Immersion in Sn96.5Ag3.0Cu0.5 solder using non- or low activated flux without preheating at 255 ±5 °C for 10 ±1 s | No leaching of contacts |
| Thermal shock (solder shock) | | Dip soldering at 300 °C/5 s | Dip soldering at 300 °C/5 s | No deterioration of electrical parameters. Capacitance change: $ \Delta C/C_0 \leq 15\%$ |
| Tests of resistance to soldering heat for SMDs | IEC 60068-2-58 | Immersion in 60/40 SnPb for 10 s at 260 °C | Immersion in Sn96.5Ag3.0Cu0.5 for 10 s at 260 °C | Change of varistor voltage: $ \Delta V/V (1 \text{ mA}) \leq 5\%$ |
| Tests of resistance to soldering heat for radial leaded components (SHCV) | IEC 60068-2-20 | Immersion of leads in 60/40 SnPb for 10 s at 260 °C | Immersion of leads in Sn96.5Ag3.0Cu0.5 for 10 s at 260 °C | Change of varistor voltage: $ \Delta V/V (1 \text{ mA}) \leq 5\%$ Change of capacitance X7R: $\leq -5/+10\%$ |

Multilayer varistors (MLVs)

Automotive E series

SMD

Note:

Leaching of the termination

Effective area at the termination might be lost if the soldering temperature and/or immersion time are not kept within the recommended conditions. Leaching of the outer electrode should not exceed 25% of the chip end area (full length of the edge A-B-C-D) and 25% of the length A-B, shown below as mounted on substrate.



As a single chip



As mounted on substrate

5 Notes for proper soldering

5.1 Preheating and cooling

- According to IEC 60068-2-58. Please refer to section 2 of this chapter.

5.2 Repair/ rework

Manual soldering with a soldering iron must be avoided, hot-air methods are recommended for rework purposes.

5.3 Cleaning

All environmentally compatible agents are suitable for cleaning. Select the appropriate cleaning solution according to the type of flux used. The temperature difference between the components and cleaning liquid must not be greater than 100 °C. Ultrasonic cleaning should be carried out with the utmost caution. Too high ultrasonic power can impair the adhesive strength of the metalized surfaces.

5.4 Solder paste printing (reflow soldering)

An excessive application of solder paste results in too high a solder fillet, thus making the chip more susceptible to mechanical and thermal stress. Too little solder paste reduces the adhesive strength on the outer electrodes and thus weakens the bonding to the PCB. The solder should be applied smoothly to the end surface.

Multilayer varistors (MLVs)

Automotive E series

SMD

5.5 Selection of flux

Used flux should have less than or equal to 0.1 wt % of halogenated content, since flux residue after soldering could lead to corrosion of the termination and/or increased leakage current on the surface of the component. Strong acidic flux must not be used. The amount of flux applied should be carefully controlled, since an excess may generate flux gas, which in turn is detrimental to solderability.

5.6 Storage of CTVSs

Solderability is guaranteed for one year from date of delivery for multilayer varistors, CeraDiodes and ESD/EMI filters (half a year for chips with AgPt terminations) and two years for SHCV components, provided that components are stored in their original packages.

Storage temperature: $-25\text{ }^{\circ}\text{C}$ to $+45\text{ }^{\circ}\text{C}$

Relative humidity: $\leq 75\%$ annual average, $\leq 95\%$ on 30 days a year

The solderability of the external electrodes may deteriorate if SMDs and leaded components are stored where they are exposed to high humidity, dust or harmful gas (hydrogen chloride, sulfuric acid gas or hydrogen sulfide).

Do not store SMDs and leaded components where they are exposed to heat or direct sunlight. Otherwise the packing material may be deformed or SMDs/ leaded components may stick together, causing problems during mounting.

After opening the factory seals, such as polyvinyl-sealed packages, it is recommended to use the SMDs or leaded components as soon as possible.

Solder CTVS components after shipment from TDK Electronics within the time specified:

CTVS with Ni barrier termination: 12 months

CTVS with AgPt termination: 6 months

SHCV (leaded components): 24 months

5.7 Placement of components on circuit board

Especially in the case of dual-wave soldering, it is of advantage to place the components on the board before soldering in that way that their two terminals do not enter the solder bath at different times.

Ideally, both terminals should be wetted simultaneously.

Multilayer varistors (MLVs)

Automotive E series

SMD

5.8 Soldering cautions

An excessively long soldering time or high soldering temperature results in leaching of the outer electrodes, causing poor adhesion and a change of electrical properties of the varistor due to the loss of contact between electrodes and termination.

Keep the recommended down-cooling rate.

5.9 Standards

CECC 00802

IEC 60068-2-58

IEC 60068-2-20

Multilayer varistors (MLVs)

Automotive E series

SMD

Symbols and terms

For ceramic transient voltage suppressors (CTVS)

| Symbol | Term |
|-------------------|--|
| $C_{line,max}$ | Maximum capacitance per line |
| $C_{line,min}$ | Minimum capacitance per line |
| $C_{line,typ}$ | Typical capacitance per line |
| C_{max} | Maximum capacitance |
| C_{min} | Minimum capacitance |
| C_{nom} | Nominal capacitance |
| ΔC_{nom} | Tolerance of nominal capacitance |
| C_{typ} | Typical capacitance |
| $f_{cut-off,max}$ | Maximum cut-off frequency |
| $f_{cut-off,min}$ | Minimum cut-off frequency |
| $f_{cut-off,typ}$ | Typical cut-off frequency |
| $f_{res,typ}$ | Typical resonance frequency |
| I | Current |
| I_{clamp} | Clamping current |
| I_{leak} | Leakage current |
| $I_{leak,max}$ | Maximum leakage current |
| $I_{leak,typ}$ | Typical leakage current |
| I_{PP} | Peak pulse current |
| $I_{surge,max}$ | Maximum surge current (also termed peak current) |
| LCT | Lower category temperature |
| L_{typ} | Typical inductance |
| $P_{diss,max}$ | Maximum power dissipation |
| P_{PP} | Peak pulse power |
| R_{ins} | Insulation resistance |
| R_{min} | Minimum resistance |
| R_S | Resistance per line |
| $R_{S,typ}$ | Typical resistance per line |
| T_A | Ambient temperature |
| T_{op} | Operating temperature |
| $T_{op,max}$ | Maximum operating temperature |
| T_{stg} | Storage temperature |

Multilayer varistors (MLVs)
Automotive E series
SMD

| Symbol | Term |
|-------------------|--|
| t_r | Duration of equivalent rectangular wave |
| t_{resp} | Response time |
| $t_{resp,max}$ | Maximum response time |
| UCT | Upper category temperature |
| V | Voltage |
| $V_{BR,min}$ | Minimum breakdown voltage |
| $V_{clamp,max}$ | Maximum clamping voltage |
| $V_{DC,max}$ | Maximum DC operating voltage (also termed working voltage) |
| $V_{ESD,air}$ | Air discharge ESD capability |
| $V_{ESD,contact}$ | Contact discharge ESD capability |
| V_{jump} | Maximum jump-start voltage |
| $V_{RMS,max}$ | Maximum AC operating voltage, root-mean-square value |
| V_V | Varistor voltage (also termed breakdown voltage) |
| V_{LD} | Maximum load dump voltage |
| V_{leak} | Measurement voltage for leakage current |
| $V_{V,min}$ | Minimum varistor voltage |
| $V_{V,max}$ | Maximum varistor voltage |
| ΔV_V | Tolerance of varistor voltage |
| W_{LD} | Maximum load dump energy |
| W_{max} | Maximum energy absorption (also termed transient energy) |
| α_{typ} | Typical insertion loss |
| $\tan \delta$ | Dissipation factor |
| e | Lead spacing |
| $\ll * \gg$ | Maximum possible application conditions |

All dimensions are given in mm.

The commas used in numerical values denote decimal points.

Multilayer varistors (MLVs)

Automotive E series

SMD

Cautions and warnings

General

Some parts of this publication contain statements about the suitability of our ceramic transient voltage suppressor (CTVS) components (multilayer varistors (MLVs)), CeraDiodes, ESD/EMI filters, leaded transient voltage/ RFI suppressors (SHCV types)) for certain areas of application, including recommendations about incorporation/design-in of these products into customer applications. The statements are based on our knowledge of typical requirements often made of our CTVS devices in the particular areas. We nevertheless expressly point out that such statements cannot be regarded as binding statements about the suitability of our CTVS components for a particular customer application. As a rule, EPCOS is either unfamiliar with individual customer applications or less familiar with them than the customers themselves. For these reasons, it is always incumbent on the customer to check and decide whether the CTVS devices with the properties described in the product specification are suitable for use in a particular customer application.

- Do not use EPCOS CTVS components for purposes not identified in our specifications, application notes and data books.
- Ensure the suitability of a CTVS in particular by testing it for reliability during design-in. Always evaluate a CTVS component under worst-case conditions.
- Pay special attention to the reliability of CTVS devices intended for use in safety-critical applications (e.g. medical equipment, automotive, spacecraft, nuclear power plant).

Design notes

- Always connect a CTVS in parallel with the electronic circuit to be protected.
- Consider maximum rated power dissipation if a CTVS has insufficient time to cool down between a number of pulses occurring within a specified isolated time period. Ensure that electrical characteristics do not degrade.
- Consider derating at higher operating temperatures. Choose the highest voltage class compatible with derating at higher temperatures.
- Surge currents beyond specified values will puncture a CTVS. In extreme cases a CTVS will burst.
- If steep surge current edges are to be expected, make sure your design is as low-inductance as possible.
- In some cases the malfunctioning of passive electronic components or failure before the end of their service life cannot be completely ruled out in the current state of the art, even if they are operated as specified. In applications requiring a very high level of operational safety and especially when the malfunction or failure of a passive electronic component could endanger human life or health (e.g. in accident prevention, life-saving systems, or automotive battery line applications such as clamp 30), ensure by suitable design of the application or other measures (e.g. installation of protective circuitry or redundancy) that no injury or damage is sustained by third parties in the event of such a malfunction or failure. Only use CTVS components from the automotive series in safety-relevant applications.

Multilayer varistors (MLVs)

Automotive E series

SMD

- Specified values only apply to CTVS components that have not been subject to prior electrical, mechanical or thermal damage. The use of CTVS devices in line-to-ground applications is therefore not advisable, and it is only allowed together with safety countermeasures like thermal fuses.

Storage

- Only store CTVS in their original packaging. Do not open the package prior to processing.
- Storage conditions in original packaging: temperature -25 to $+45^{\circ}\text{C}$, relative humidity $\leq 75\%$ annual average, maximum 95%, dew precipitation is inadmissible.
- Do not store CTVS devices where they are exposed to heat or direct sunlight. Otherwise the packaging material may be deformed or CTVS may stick together, causing problems during mounting.
- Avoid contamination of the CTVS surface during storage, handling and processing.
- Avoid storing CTVS devices in harmful environments where they are exposed to corrosive gases for example (SO_x , Cl).
- Use CTVS as soon as possible after opening factory seals such as polyvinyl-sealed packages.
- Solder CTVS components after shipment from EPCOS within the time specified:
 - CTVS with Ni barrier termination, 12 months
 - CTVS with AgPt termination, 6 months
 - SHCV, 24 months

Handling

- Do not drop CTVS components and allow them to be chipped.
- Do not touch CTVS with your bare hands - gloves are recommended.
- Avoid contamination of the CTVS surface during handling.
- Washing processes may damage the product due to the possible static or cyclic mechanical loads (e.g. ultrasonic cleaning). They may cause cracks to develop on the product and its parts, which might lead to reduced reliability or lifetime.

Mounting

- When CTVS devices are encapsulated with sealing material or overmolded with plastic material, electrical characteristics might be degraded and the life time reduced.
- Make sure an electrode is not scratched before, during or after the mounting process.
- Make sure contacts and housings used for assembly with CTVS components are clean before mounting.
- The surface temperature of an operating CTVS can be higher. Ensure that adjacent components are placed at a sufficient distance from a CTVS to allow proper cooling.
- Avoid contamination of the CTVS surface during processing.

Multilayer varistors (MLVs)

Automotive E series

SMD

Soldering

- Complete removal of flux is recommended to avoid surface contamination that can result in an instable and/or high leakage current.
- Use resin-type or non-activated flux.
- Bear in mind that insufficient preheating may cause ceramic cracks.
- Rapid cooling by dipping in solvent is not recommended, otherwise a component may crack.

Operation

- Use CTVS only within the specified operating temperature range.
- Use CTVS only within specified voltage and current ranges.
- Environmental conditions must not harm a CTVS. Only use them in normal atmospheric conditions. Reducing the atmosphere (e.g. hydrogen or nitrogen atmosphere) is prohibited.
- Prevent a CTVS from contacting liquids and solvents. Make sure that no water enters a CTVS (e.g. through plug terminals).
- Avoid dewing and condensation.
- EPCOS CTVS components are mainly designed for encased applications. Under all circumstances avoid exposure to:
 - direct sunlight
 - rain or condensation
 - steam, saline spray
 - corrosive gases
 - atmosphere with reduced oxygen content
- EPCOS CTVS devices are not suitable for switching applications or voltage stabilization where static power dissipation is required.

This listing does not claim to be complete, but merely reflects the experience of EPCOS AG.

Display of ordering codes for EPCOS products

The ordering code for one and the same EPCOS product can be represented differently in data sheets, data books, other publications, on the EPCOS website, or in order-related documents such as shipping notes, order confirmations and product labels. **The varying representations of the ordering codes are due to different processes employed and do not affect the specifications of the respective products.** Detailed information can be found on the Internet under www.epcos.com/orderingcodes

Important notes

The following applies to all products named in this publication:

1. Some parts of this publication contain **statements about the suitability of our products for certain areas of application**. These statements are based on our knowledge of typical requirements that are often placed on our products in the areas of application concerned. We nevertheless expressly point out **that such statements cannot be regarded as binding statements about the suitability of our products for a particular customer application**. As a rule, we are either unfamiliar with individual customer applications or less familiar with them than the customers themselves. For these reasons, it is always ultimately incumbent on the customer to check and decide whether a product with the properties described in the product specification is suitable for use in a particular customer application.
2. We also point out that **in individual cases, a malfunction of electronic components or failure before the end of their usual service life cannot be completely ruled out in the current state of the art, even if they are operated as specified**. In customer applications requiring a very high level of operational safety and especially in customer applications in which the malfunction or failure of an electronic component could endanger human life or health (e.g. in accident prevention or lifesaving systems), it must therefore be ensured by means of suitable design of the customer application or other action taken by the customer (e.g. installation of protective circuitry or redundancy) that no injury or damage is sustained by third parties in the event of malfunction or failure of an electronic component.
3. **The warnings, cautions and product-specific notes must be observed.**
4. In order to satisfy certain technical requirements, **some of the products described in this publication may contain substances subject to restrictions in certain jurisdictions (e.g. because they are classed as hazardous)**. Useful information on this will be found in our Material Data Sheets on the Internet (www.tdk-electronics.tdk.com/material). Should you have any more detailed questions, please contact our sales offices.
5. We constantly strive to improve our products. Consequently, **the products described in this publication may change from time to time**. The same is true of the corresponding product specifications. Please check therefore to what extent product descriptions and specifications contained in this publication are still applicable before or when you place an order. We also **reserve the right to discontinue production and delivery of products**. Consequently, we cannot guarantee that all products named in this publication will always be available. The aforementioned does not apply in the case of individual agreements deviating from the foregoing for customer-specific products.
6. Unless otherwise agreed in individual contracts, **all orders are subject to our General Terms and Conditions of Supply**.

Important notes

7. **Our manufacturing sites serving the automotive business apply the IATF 16949 standard.** The IATF certifications confirm our compliance with requirements regarding the quality management system in the automotive industry. Referring to customer requirements and customer specific requirements (“CSR”) TDK always has and will continue to have the policy of respecting individual agreements. Even if IATF 16949 may appear to support the acceptance of unilateral requirements, we hereby like to emphasize that **only requirements mutually agreed upon can and will be implemented in our Quality Management System.** For clarification purposes we like to point out that obligations from IATF 16949 shall only become legally binding if individually agreed upon.
8. The trade names EPCOS, CeraCharge, CeraDiode, CeraLink, CeraPad, CeraPlas, CSMP, CTVS, DeltaCap, DigiSiMic, ExoCore, FilterCap, FormFit, LeaXield, MiniBlue, MiniCell, MKD, MKK, MotorCap, PCC, PhaseCap, PhaseCube, PhaseMod, PhiCap, PowerHap, PQSine, PQvar, SIFERRIT, SIFI, SIKOREL, SilverCap, SIMDAD, SiMic, SIMID, SineFormer, SIOV, ThermoFuse, WindCap are **trademarks registered or pending** in Europe and in other countries. Further information will be found on the Internet at www.tdk-electronics.tdk.com/trademarks.

Release 2018-10

Mouser Electronics

Authorized Distributor

Click to View Pricing, Inventory, Delivery & Lifecycle Information:

EPCOS / TDK:

| | | | | |
|--|--|--|--|--|
| <u>B72500E0140K060</u> | <u>B72500E0140S260</u> | <u>B72500E0170K060</u> | <u>B72500E0200K060</u> | <u>B72500E0250K060</u> |
| <u>B72500E1140S260</u> | <u>B72500E2170K060</u> | <u>B72500E2170S160</u> | <u>B72500E5170S260</u> | <u>B72500E5200S160</u> |
| <u>B72510E0110K062</u> | <u>B72510E0140K062</u> | <u>B72510E0170K062</u> | <u>B72510E0200K062</u> | <u>B72510E0250K062</u> |
| <u>B72510E0300K062</u> | <u>B72510E1140S262</u> | <u>B72510E2170K062</u> | <u>B72510E9200S172</u> | <u>B72530E1140S262</u> |
| <u>B72580E0250K062</u> | <u>B72530E0250K062</u> | <u>B72520E0250K062</u> | <u>B72540E1300K062</u> | <u>B72540E0170K062</u> |
| <u>B72530E0170K062</u> | <u>B72520E0400K062</u> | <u>B72510E1250K062</u> | <u>B72540E0300K062</u> | <u>B72530E1250K062</u> |
| <u>B72520E1200K062</u> | <u>B72580E0140K062</u> | <u>B72580E0300K062</u> | <u>B72530E1200K062</u> | <u>B72540E0350K062</u> |
| <u>B72520E1250K062</u> | <u>B72540E3140S272</u> | <u>B72520E0350K062</u> | <u>B72530E0300K062</u> | <u>B72580E1140S262</u> |
| <u>B72520E0170K062</u> | <u>B72530E1170K062</u> | <u>B72590E8140S160</u> | <u>B72540E3300K072</u> | <u>B72540E0140K062</u> |
| <u>B72530E0200K062</u> | <u>B72580E3140S272</u> | <u>B72500E5250L060</u> | <u>B72520E0200K062</u> | <u>B72530E0350K062</u> |
| <u>B72520E1140S262</u> | <u>B72580E0200K062</u> | <u>B72590E0140L060</u> | <u>B72520E0140K062</u> | <u>B72530E0140K062</u> |
| <u>B72540E1140S262</u> | <u>B72580E0350K062</u> | <u>B72540E0250K062</u> | <u>B72540E0200K062</u> | <u>B72520E0300K062</u> |
| <u>B72580E0170K062</u> | <u>B72510E0350K062</u> | <u>B72540E0400K062</u> | <u>B72590E0170S160</u> | |

Данный компонент на территории Российской Федерации

Вы можете приобрести в компании MosChip.

Для оперативного оформления запроса Вам необходимо перейти по данной ссылке:

<http://moschip.ru/get-element>

Вы можете разместить у нас заказ для любого Вашего проекта, будь то серийное производство или разработка единичного прибора.

В нашем ассортименте представлены ведущие мировые производители активных и пассивных электронных компонентов.

Нашей специализацией является поставка электронной компонентной базы двойного назначения, продукции таких производителей как XILINX, Intel (ex.ALTERA), Vicor, Microchip, Texas Instruments, Analog Devices, Mini-Circuits, Amphenol, Glenair.

Сотрудничество с глобальными дистрибьюторами электронных компонентов, предоставляет возможность заказывать и получать с международных складов практически любой перечень компонентов в оптимальные для Вас сроки.

На всех этапах разработки и производства наши партнеры могут получить квалифицированную поддержку опытных инженеров.

Система менеджмента качества компании отвечает требованиям в соответствии с ГОСТ Р ИСО 9001, ГОСТ РВ 0015-002 и ЭС РД 009

Офис по работе с юридическими лицами:

105318, г.Москва, ул.Щербаковская д.3, офис 1107, 1118, ДЦ «Щербаковский»

Телефон: +7 495 668-12-70 (многоканальный)

Факс: +7 495 668-12-70 (доб.304)

E-mail: info@moschip.ru

Skype отдела продаж:

moschip.ru

moschip.ru_4

moschip.ru_6

moschip.ru_9