

Thunderbolt IGBT®

The Thunderbolt IGBT® is a new generation of high voltage power IGBTs. Using Non-Punch Through Technology, the Thunderbolt IGBT® offers superior ruggedness and ultrafast switching speed.

- Low Forward Voltage Drop
- High Freq. Switching to 150KHz
- Low Tail Current
- Ultra Low Leakage Current
- RBSOA and SCSOA Rated

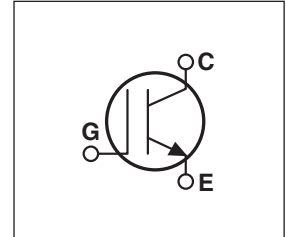
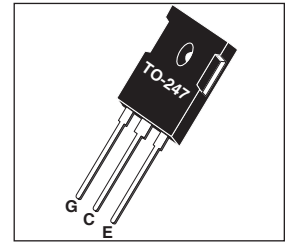

MAXIMUM RATINGS

All Ratings: $T_C = 25^\circ\text{C}$ unless otherwise specified.

| Symbol | Parameter | APT15GT60BR(G) | UNIT |
|----------------|---|----------------|------------------|
| V_{CES} | Collector-Emitter Voltage | 600 | Volts |
| V_{GE} | Gate-Emitter Voltage | ± 30 | |
| I_{C1} | Continuous Collector Current @ $T_C = 25^\circ\text{C}$ | 42 | Amps |
| I_{C2} | Continuous Collector Current @ $T_C = 110^\circ\text{C}$ | 20 | |
| I_{CM} | Pulsed Collector Current ^① | 45 | |
| SSOA | Switching Safe Operating Area @ $T_J = 150^\circ\text{C}$ | 45A @ 600V | |
| P_D | Total Power Dissipation | 184 | Watts |
| T_J, T_{STG} | Operating and Storage Junction Temperature Range | -55 to 150 | $^\circ\text{C}$ |
| T_L | Max. Lead Temp. for Soldering: 0.063" from Case for 10 Sec. | 300 | |

STATIC ELECTRICAL CHARACTERISTICS

| Symbol | Characteristic / Test Conditions | MIN | TYP | MAX | Units |
|---------------|--|-----|-----|-----------|---------------|
| $V_{(BR)CES}$ | Collector-Emitter Breakdown Voltage ($V_{GE} = 0V, I_C = 250\mu\text{A}$) | 600 | | | Volts |
| $V_{GE(TH)}$ | Gate Threshold Voltage ($V_{CE} = V_{GE}, I_C = 700\mu\text{A}, T_J = 25^\circ\text{C}$) | 3 | 4 | 5 | |
| $V_{CE(ON)}$ | Collector-Emitter On Voltage ($V_{GE} = 15V, I_C = 15A, T_J = 25^\circ\text{C}$) | 1.6 | 2.0 | 2.5 | |
| | Collector-Emitter On Voltage ($V_{GE} = 15V, I_C = 15A, T_J = 125^\circ\text{C}$) | | 2.8 | | |
| I_{CES} | Collector Cut-off Current ($V_{CE} = 600V, V_{GE} = 0V, T_J = 25^\circ\text{C}$) ^② | | | 25 | μA |
| | Collector Cut-off Current ($V_{CE} = 600V, V_{GE} = 0V, T_J = 125^\circ\text{C}$) ^② | | | 1500 | |
| I_{GES} | Gate-Emitter Leakage Current ($V_{GE} = \pm 20V$) | | | ± 100 | nA |



CAUTION: These Devices are Sensitive to Electrostatic Discharge. Proper Handling Procedures Should Be Followed.

DYNAMIC CHARACTERISTICS

APT15GT60BR(G)

| Symbol | Characteristic | Test Conditions | MIN | TYP | MAX | UNIT | |
|--------------|---|--|-----|-----|-----|------|----|
| C_{ies} | Input Capacitance | Capacitance $V_{GE} = 0V, V_{CE} = 25V$ $f = 1 \text{ MHz}$ | | 830 | | pF | |
| C_{oes} | Output Capacitance | | | 120 | | | |
| C_{res} | Reverse Transfer Capacitance | | | 50 | | | |
| V_{GEP} | Gate-to-Emitter Plateau Voltage | Gate Charge | | 7.5 | | V | |
| Q_g | Total Gate Charge ^③ | $V_{GE} = 15V$ | | 75 | | nC | |
| Q_{ge} | Gate-Emitter Charge | $V_{CE} = 300V$ | | 6 | | | |
| Q_{gc} | Gate-Collector ("Miller") Charge | $I_C = 15A$ | | 34 | | | |
| SSOA | Switching Safe Operating Area | $T_J = 150^\circ\text{C}, R_G = 10\Omega, V_{GE} = 15V, L = 100\mu\text{H}, V_{CE} = 600V$ | 45 | | | A | |
| $t_{d(on)}$ | Turn-on Delay Time | Inductive Switching (25°C) $V_{CC} = 400V$ $V_{GE} = 15V$ $I_C = 15A$ $R_G = 10\Omega$ $T_J = +25^\circ\text{C}$ | | 6 | | ns | |
| t_r | Current Rise Time | | | 8 | | | |
| $t_{d(off)}$ | Turn-off Delay Time | | | 105 | | | |
| t_f | Current Fall Time | | | 55 | | | |
| E_{on1} | Turn-on Switching Energy ^④ | | | | 150 | | μJ |
| E_{on2} | Turn-on Switching Energy (Diode) ^⑤ | | | 195 | | | |
| E_{off} | Turn-off Switching Energy ^⑥ | | | 215 | | | |
| $t_{d(on)}$ | Turn-on Delay Time | Inductive Switching (125°C) $V_{CC} = 400V$ $V_{GE} = 15V$ $I_C = 15A$ $R_G = 10\Omega$ $T_J = +125^\circ\text{C}$ | | 6 | | ns | |
| t_r | Current Rise Time | | | 8 | | | |
| $t_{d(off)}$ | Turn-off Delay Time | | | 125 | | | |
| t_f | Current Fall Time | | | 100 | | | |
| E_{on1} | Turn-on Switching Energy ^④ | | | | 150 | | μJ |
| E_{on2} | Turn-on Switching Energy (Diode) ^⑤ | | | | 325 | | |
| E_{off} | Turn-off Switching Energy ^⑥ | | | | 325 | | |

THERMAL AND MECHANICAL CHARACTERISTICS

| Symbol | Characteristic | MIN | TYP | MAX | UNIT |
|-----------------|--------------------------|-----|-----|-----|------|
| $R_{\theta JC}$ | Junction to Case (IGBT) | | | .68 | °C/W |
| $R_{\theta JC}$ | Junction to Case (DIODE) | | | N/A | |
| W_T | Package Weight | | 5.9 | | gm |

① Repetitive Rating: Pulse width limited by maximum junction temperature.

② For Combi devices, I_{ces} includes both IGBT and FRED leakages

③ See MIL-STD-750 Method 3471.

④ E_{on1} is the clamped inductive turn-on energy of the IGBT only, without the effect of a commutating diode reverse recovery current adding to the IGBT turn-on loss. Tested in inductive switching test circuit shown in figure 21, but with a Silicon Carbide diode.

⑤ E_{on2} is the clamped inductive turn-on energy that includes a commutating diode reverse recovery current in the IGBT turn-on switching loss. (See Figures 21, 22.)

⑥ E_{off} is the clamped inductive turn-off energy measured in accordance with JEDEC standard JESD24-1. (See Figures 21, 23.)

APT Reserves the right to change, without notice, the specifications and information contained herein.

TYPICAL PERFORMANCE CURVES

APT15GT60BR(G)

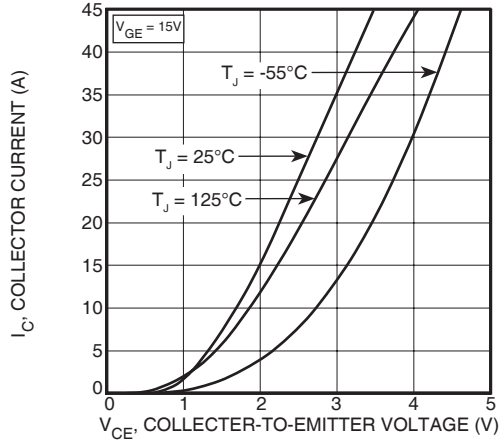

FIGURE 1, Output Characteristics($T_J = 25^\circ\text{C}$)

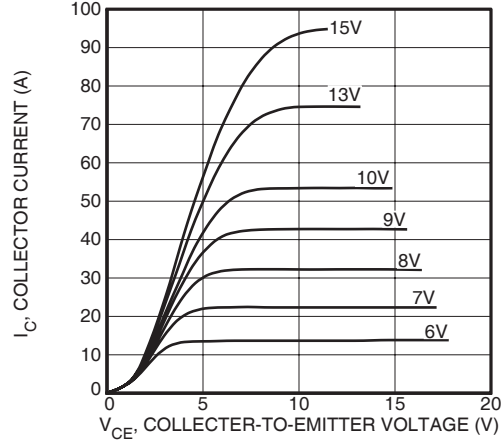

FIGURE 2, Output Characteristics ($T_J = 125^\circ\text{C}$)

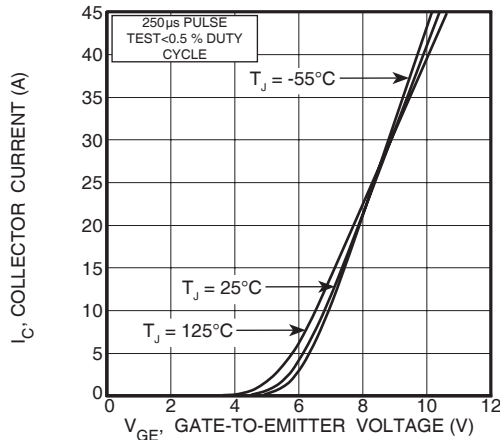

FIGURE 3, Transfer Characteristics

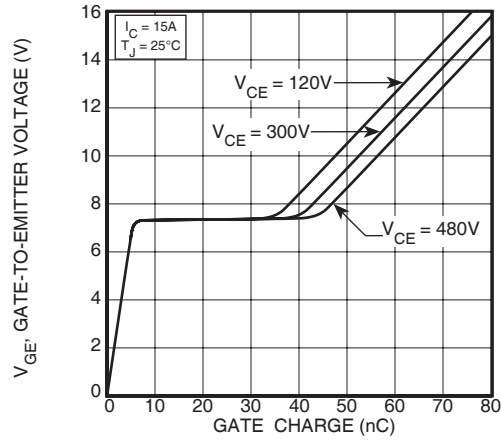

FIGURE 4, Gate Charge

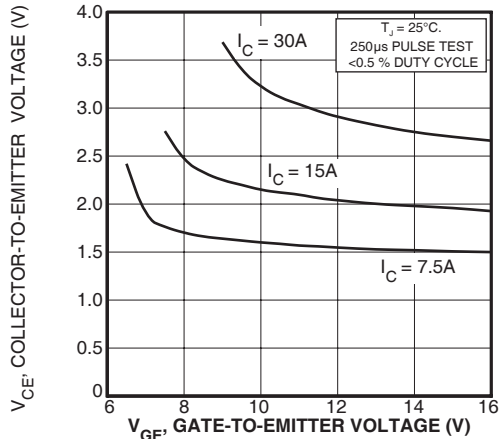

FIGURE 5, On State Voltage vs Gate-to-Emitter Voltage

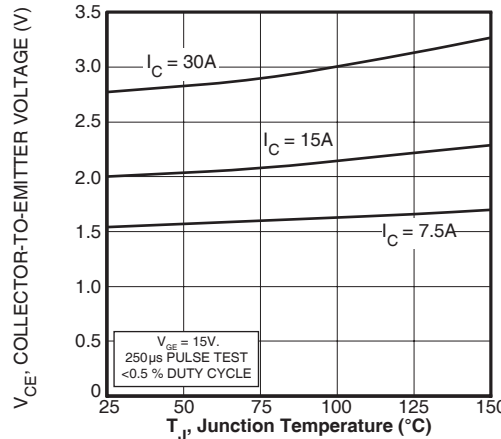

FIGURE 6, On State Voltage vs Junction Temperature

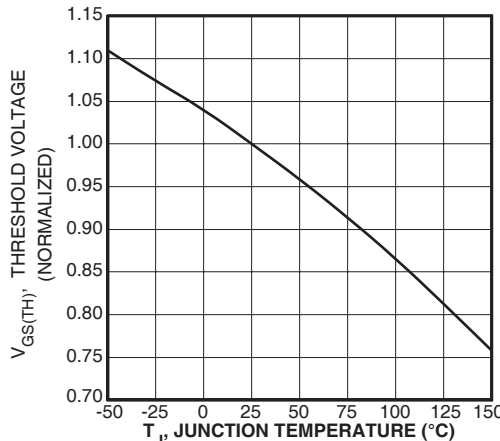

FIGURE 7, Threshold Voltage vs. Junction Temperature

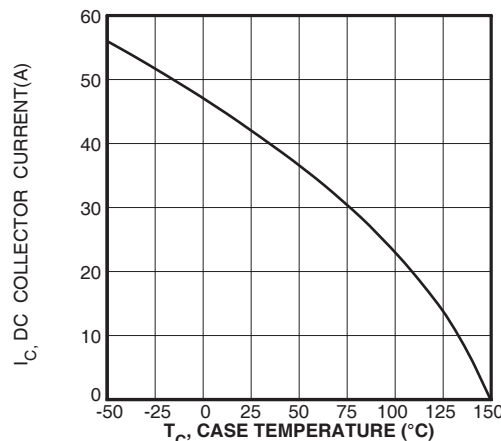

FIGURE 8, DC Collector Current vs Case Temperature

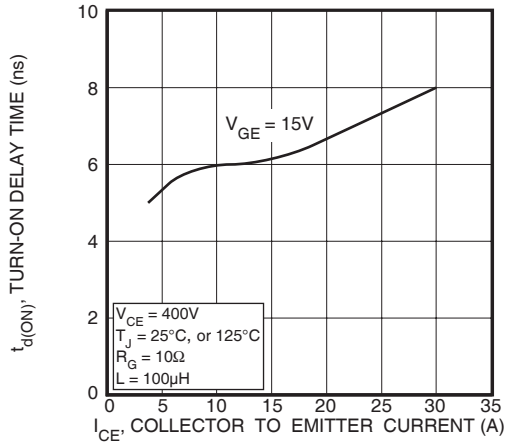

FIGURE 9, Turn-On Delay Time vs Collector Current

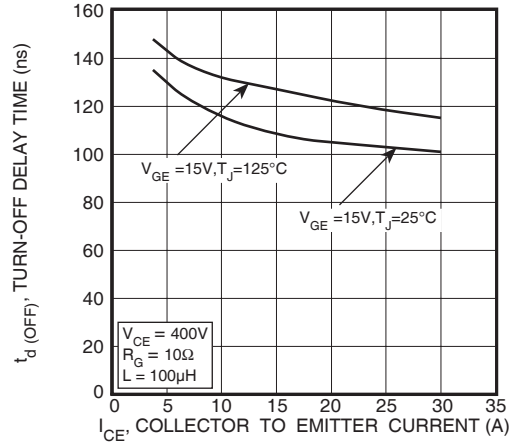

FIGURE 10, Turn-Off Delay Time vs Collector Current

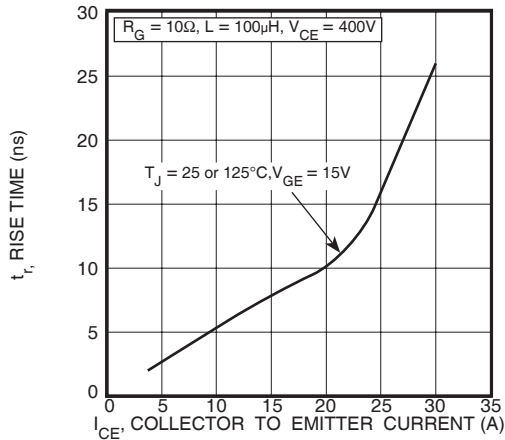

FIGURE 11, Current Rise Time vs Collector Current

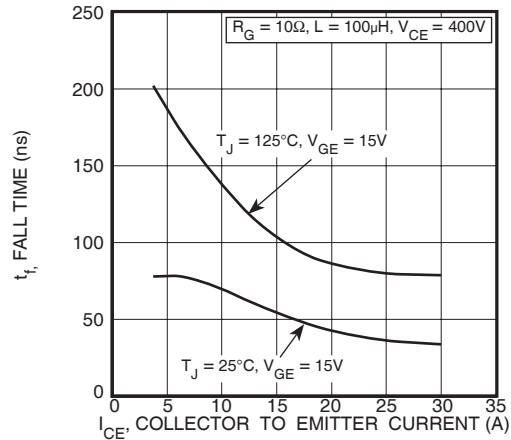

FIGURE 12, Current Fall Time vs Collector Current

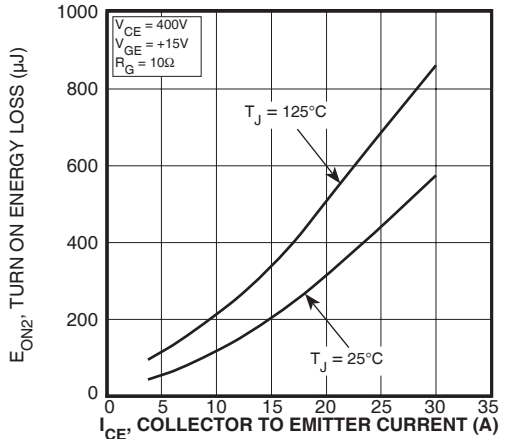

FIGURE 13, Turn-On Energy Loss vs Collector Current

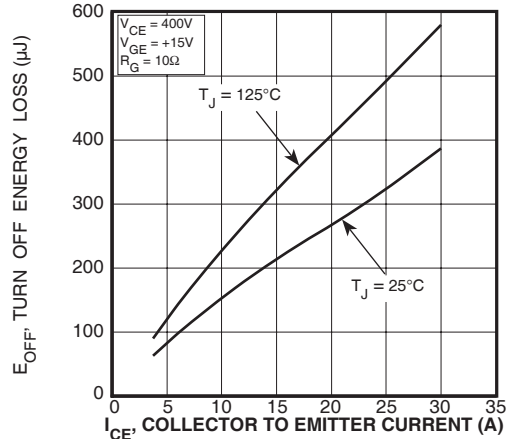

FIGURE 14, Turn Off Energy Loss vs Collector Current

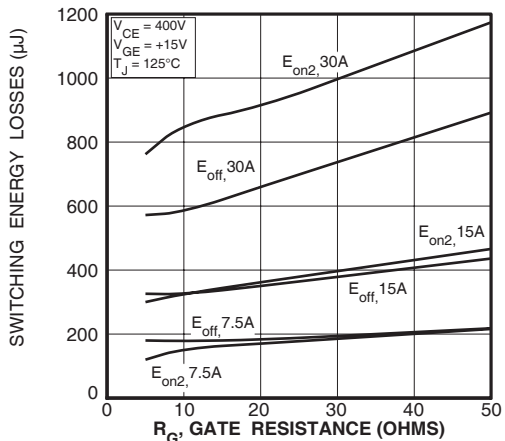

FIGURE 15, Switching Energy Losses vs. Gate Resistance

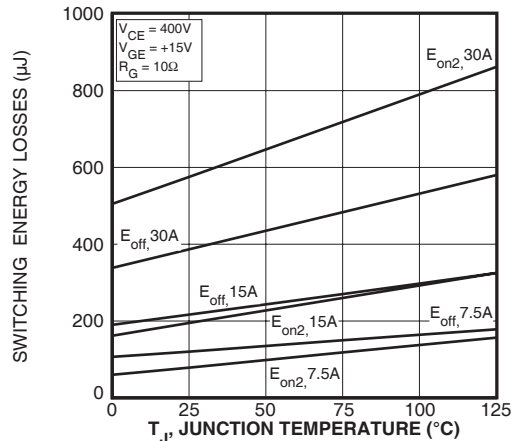

FIGURE 16, Switching Energy Losses vs Junction Temperature

TYPICAL PERFORMANCE CURVES

APT15GT60BR(G)

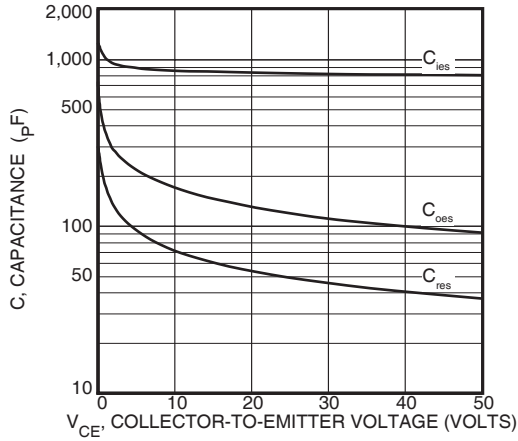

Figure 17, Capacitance vs Collector-To-Emitter Voltage

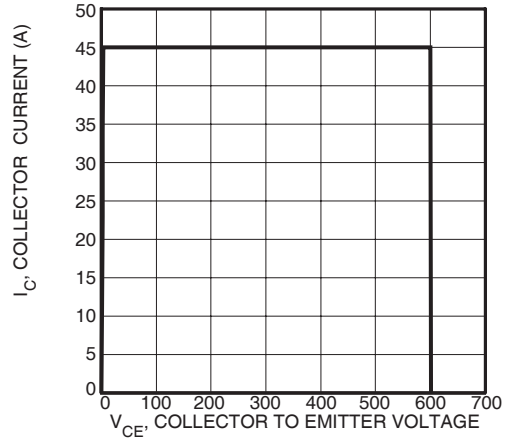

Figure 18, Minimum Switching Safe Operating Area

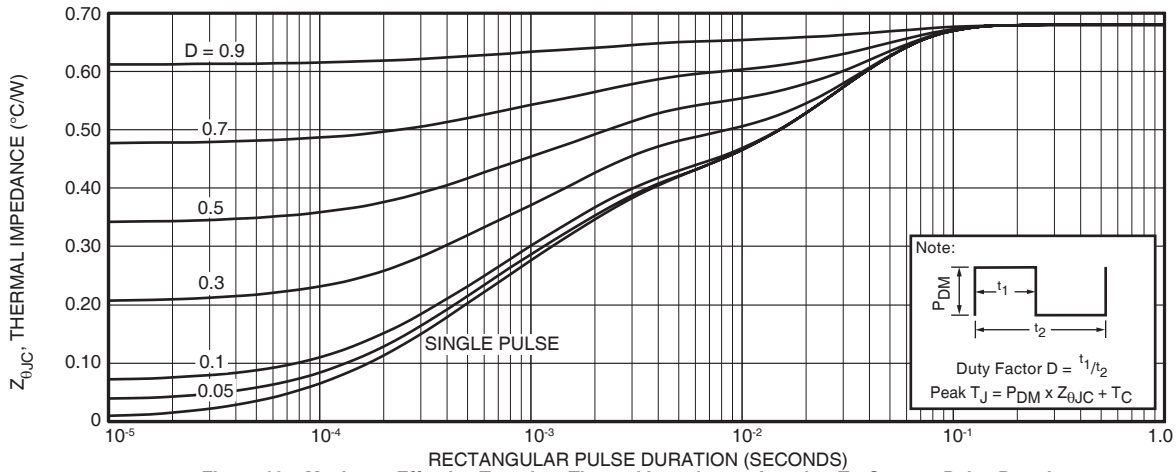

Figure 19a, Maximum Effective Transient Thermal Impedance, Junction-To-Case vs Pulse Duration

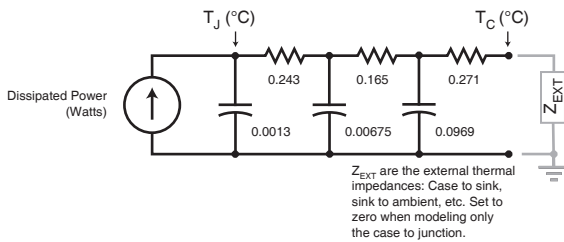

FIGURE 19b, TRANSIENT THERMAL IMPEDANCE MODEL

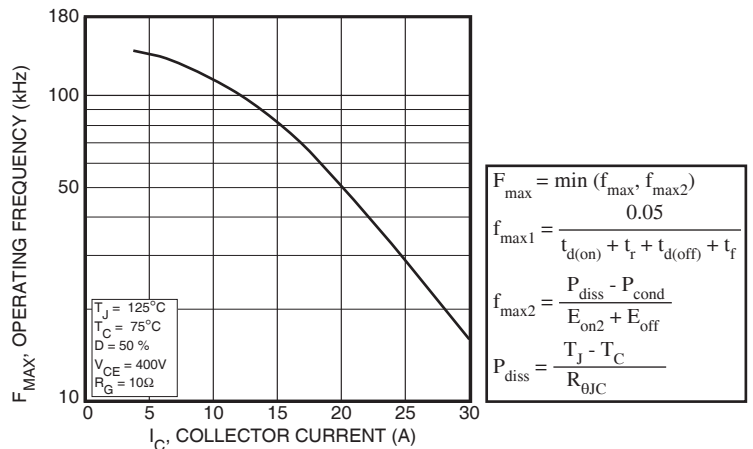

Figure 20, Operating Frequency vs Collector Current

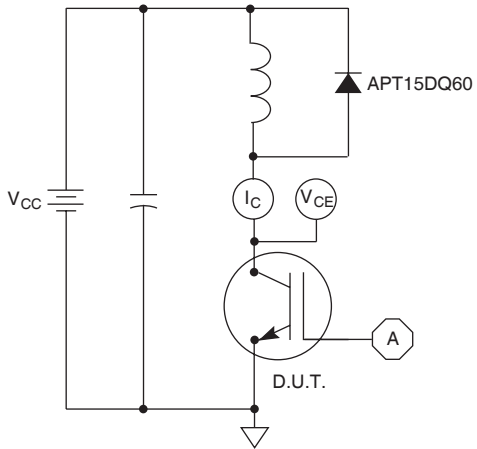

Figure 21, Inductive Switching Test Circuit

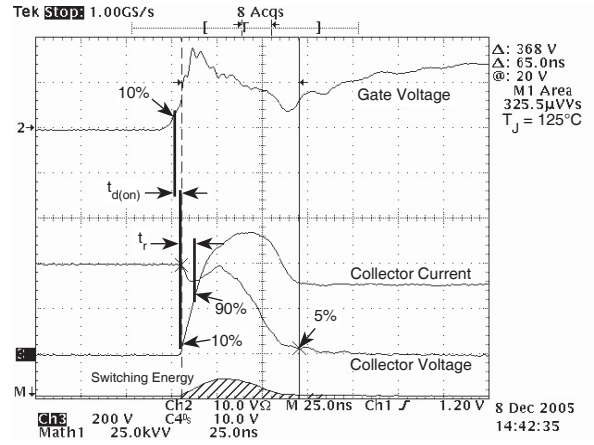

Figure 22, Turn-on Switching Waveforms and Definitions

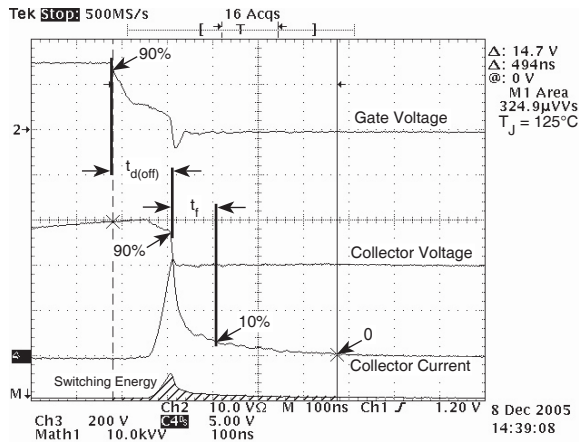
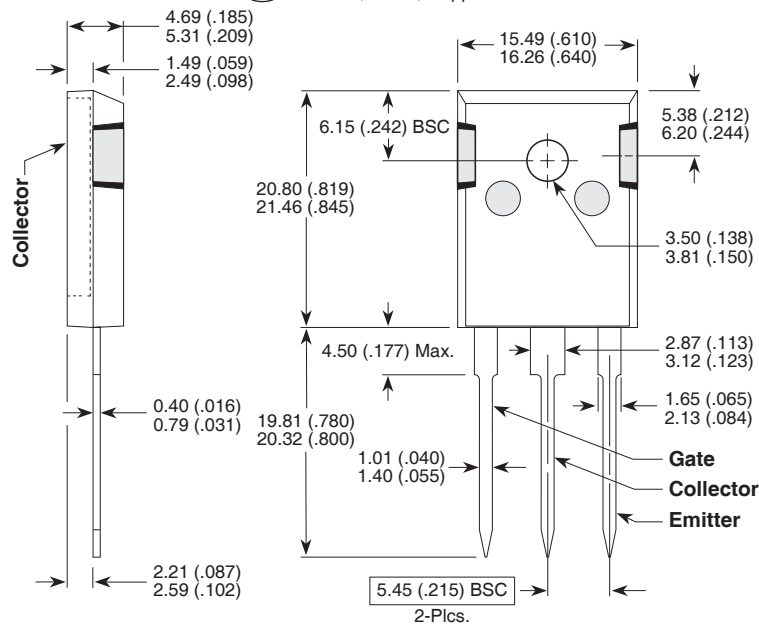

Figure 23, Turn-off Switching Waveforms and Definitions

TO-247 Package Outline

(e1) SAC: Tin, Silver, Copper



Dimensions in Millimeters and (Inches)

Данный компонент на территории Российской Федерации

Вы можете приобрести в компании MosChip.

Для оперативного оформления запроса Вам необходимо перейти по данной ссылке:

<http://moschip.ru/get-element>

Вы можете разместить у нас заказ для любого Вашего проекта, будь то серийное производство или разработка единичного прибора.

В нашем ассортименте представлены ведущие мировые производители активных и пассивных электронных компонентов.

Нашей специализацией является поставка электронной компонентной базы двойного назначения, продукции таких производителей как XILINX, Intel (ex.ALTERA), Vicor, Microchip, Texas Instruments, Analog Devices, Mini-Circuits, Amphenol, Glenair.

Сотрудничество с глобальными дистрибьюторами электронных компонентов, предоставляет возможность заказывать и получать с международных складов практически любой перечень компонентов в оптимальные для Вас сроки.

На всех этапах разработки и производства наши партнеры могут получить квалифицированную поддержку опытных инженеров.

Система менеджмента качества компании отвечает требованиям в соответствии с ГОСТ Р ИСО 9001, ГОСТ РВ 0015-002 и ЭС РД 009

Офис по работе с юридическими лицами:

105318, г.Москва, ул.Щербаковская д.3, офис 1107, 1118, ДЦ «Щербаковский»

Телефон: +7 495 668-12-70 (многоканальный)

Факс: +7 495 668-12-70 (доб.304)

E-mail: info@moschip.ru

Skype отдела продаж:

moschip.ru

moschip.ru_4

moschip.ru_6

moschip.ru_9