

Series 2600B

- Tightly integrated, 4-quadrant voltage/current source and measure instruments offer best in class performance with 6½-digit resolution
- Family of models offer industry's widest dynamic range: 10A pulse to 0.1fA and 200V to 100nV
- Built-in web browser based software enables remote control through any browser, on any computer, from anywhere in the world
- Compatibility with the Keithley IVy mobile app enables true plug & play I/V characterization and test through any Android device
- TSP (Test Script Processing) technology embeds complete test programs inside the instrument for best-in-class system-level throughput
- TSP-Link expansion technology for multi-channel parallel test without a mainframe
- Software emulation for Keithley's Model 2400 SourceMeter SMU Instrument
- USB 2.0, LXI-C, GPIB, RS-232, and digital I/O interfaces
- Free software drivers and development/debug tools
- Optional ACS-Basic semiconductor component characterization software

System SourceMeter® SMU Instruments



The Series 2600B System SourceMeter SMU Instruments are the industry's leading current/voltage source and measure solutions, and are built from Keithley's third generation SMU technology. The Series 2600B offers single- and dual-channel models that combine the capabilities of a precision power supply, true current source, 6½-digit DMM, arbitrary waveform generator, pulse generator, and electronic load – all into one tightly integrated instrument. The result is a powerful solution that significantly boosts productivity in applications ranging from bench-top I-V characterization through highly automated production test. Built-in web browser based software enables I-V testing through any computer from anywhere in the world. Or, use your Android smart device to perform plug & play I-V testing with fingertip control with the Keithley IVy application. For automated system applications, the Series 2600B's Test Script Processor (TSP®) runs complete test programs from inside the instrument for industry-best throughput. In larger, multi-channel applications, Keithley's TSP-Link® Technology works together with TSP Technology to enable high-speed, SMU-per-pin parallel testing. Because Series 2600B SourceMeter SMU Instruments have fully isolated channels that do not require a mainframe, they can be easily reconfigured and re-deployed as your test applications evolve.

Perform Quick I-V characterization with Android™ Devices

The Series 2600B is compatible with the Keithley IVy application that is the fastest and easiest way to perform current-voltage (I-V) characterization, troubleshoot your device under test (DUT), and share the measurement results with others. It allows you to visualize, interact with, and share measurement results without programming, while gaining a deeper understanding of your DUT. These unique capabilities boost productivity across a wide range of applications in R&D, education, QA/EA, and more.

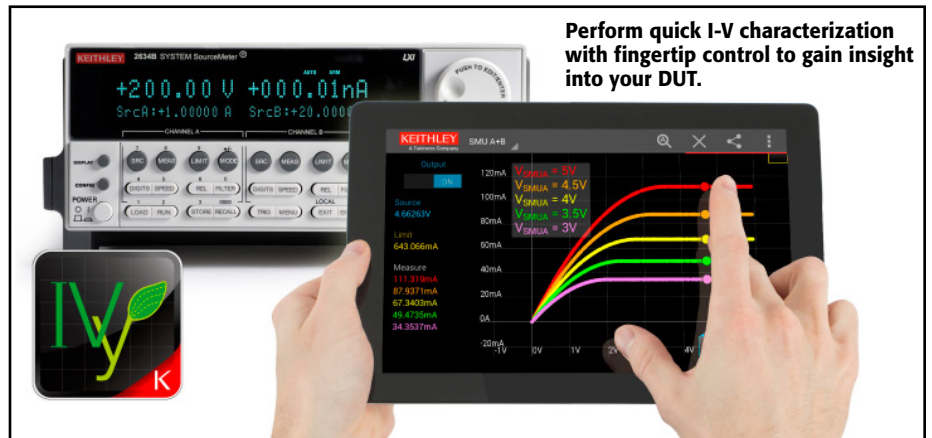

1.888.KEITHLEY (U.S. only)

www.keithley.com

A Greater Measure of Confidence

KEITHLEY

A Tektronix Company

Scalable, integrated source and measure solutions

SMU INSTRUMENTS

Series 2600B

Ordering Information

- 2601B** Single-channel System SourceMeter SMU Instrument (3A DC, 10A Pulse)
- 2602B** Dual-channel System SourceMeter SMU Instrument (3A DC, 10A Pulse)
- 2604B** Dual-channel System SourceMeter SMU Instrument (3A DC, 10A Pulse, Benchtop Version)
- 2611B** Single-channel System SourceMeter SMU Instrument (200V, 10A Pulse)
- 2612B** Dual-channel System SourceMeter SMU Instrument (200V, 10A Pulse)
- 2614B** Dual-channel System SourceMeter SMU Instrument (200V, 10A Pulse, Benchtop Version)
- 2634B** Dual-channel System SourceMeter SMU Instrument (1fA, 10A Pulse, Benchtop Version)
- 2635B** Single-channel System SourceMeter SMU Instrument (0.1fA, 10A Pulse)
- 2636B** Dual-channel System SourceMeter SMU Instrument (0.1fA, 10A Pulse)

Accessories Supplied

Operators and Programming Manuals

2600-ALG-2: Low Noise Triax Cable with Alligator Clips, 2m (6.6 ft.) (two supplied with 2634B and 2636B, one with 2635B)

2600-Kit: Screw Terminal Connector Kit (2601B/2602B/2604B/2611B/2612B/2614B)

2600B-800A: Series 2400 Emulation Script for Series 2600B (supplied on USB memory stick)

7709-308A: Digital I/O Connector

CA-180-3A: TSP-Link/Ethernet Cable (two per unit)

TSP Express Software Tool (embedded)

Test Script Builder Software (supplied on CD)

LabVIEW Driver (supplied on CD)

ACS Basic Edition Software (optional)

System SourceMeter[®] SMU Instruments

Unmatched Throughput for Automated Test with TSP Technology

For test applications that demand the highest levels of automation and throughput, the Model 2600B's TSP technology delivers industry-best performance. TSP technology goes far beyond traditional test command sequencers... it fully embeds then executes complete test programs from within the SMU instrument itself. This virtually eliminates all the time-consuming bus communications to and from the PC controller, and thus dramatically improves overall test times.

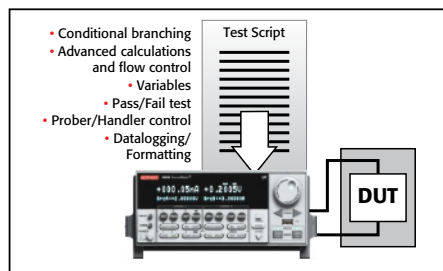

TSP technology executes complete test programs from the 2600B's non-volatile memory.

SMU-Per-Pin Parallel Testing with TSP-Link Technology

TSP-Link is a channel expansion bus that enables multiple Series 2600B's to be inter-connected and function as a single, tightly-synchronized, multi-channel system. The 2600B's TSP-Link Technology works together with its TSP technology to enable high-speed, SMU-per-pin parallel testing. Unlike other high-speed solutions such as large ATE systems, the 2600B achieves parallel test performance without the cost or burden of a mainframe. The TSP-Link based system also enables superior flexibility, allowing for quick and easy system re-configuration as test requirements change.

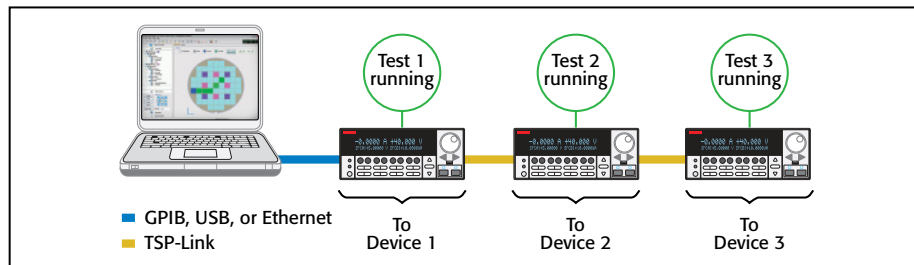

SMU-Per-Pin Parallel Testing using TSP and TSP-Link improves test throughput and lowers the cost of test.

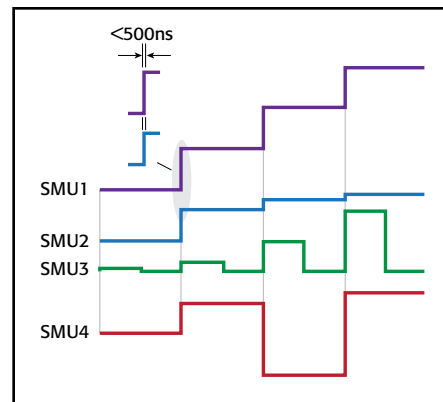

All channels in the TSP-Link system are synchronized to under 500ns.

Model 2400 Software Emulation

The Series 2600B is compatible with test code developed for Keithley's Model 2400 SourceMeter SMU instrument. This enables an easier upgrade from Model 2400-based test systems to Series 2600B, and can improve test speeds by as much as 80%. In addition, it provides a migration path from SCPI programming to Keithley's TSP technology, which when implemented can improve test times even more. For complete support of legacy test systems, the Model 2400's Source-Memory-List test sequencer is also fully supported in this mode.

Third-generation SMU Instrument Design Ensures Faster Test Times

Based on the proven architecture of earlier Series 2600 instruments, the Series 2600B's SMU instrument design enhances test speed in several ways. For example, while earlier designs used a parallel current ranging topology, the Series 2600B uses a patented series ranging topology, which provides faster and smoother range changes and outputs that settle more quickly.

1.888.KEITHLEY (U.S. only)

www.keithley.com

Series 2600B

System SourceMeter® SMU Instruments

The Series 2600B SMU instrument design supports two modes of operation for use with a variety of loads. In normal mode, the SMU instrument provides high bandwidth performance for maximum throughput. In high capacitance (high-C) mode, the SMU instrument uses a slower bandwidth to provide robust performance with higher capacitive loads.

Simplify Semiconductor Component Test, Verification, and Analysis

The optional ACS Basic Edition software maximizes the productivity of customers who perform packaged part characterization during development, quality verification, or failure analysis. Key features include:

- Rich set of easy-to-access test libraries
- Script editor for fast customization of existing tests
- Data tool for comparing results quickly
- Formulator tool that analyzes captured curves and provides a wide range of math functions

For more information about the ACS Basic Edition software, please refer to the ACS Basic Edition data sheet.

Powerful Software Tools

In addition to compatibility with the Keithley IVy smart device app, embedded web browser based software, and optional ACS Basic Edition software, the free Test Script Builder software tool is provided to help users create, modify, debug, and store TSP test scripts. Table 1 describes key features of Series 2600B software tools.

Three New Dual-Channel Bench-Top Models of Series 2600B Offer Industry-Best Value and Performance

For applications that do not require leading-edge system-level automation capabilities, Keithley has expanded the Series 2600B to include 3 new value-priced “bench-top” models – the 2604B, 2614B, and 2634B. These models offer similar performance to Models 2602B, 2612B, and 2636B, respectively, however do not include TSP-Link, Contact Check, and Digital I/O capabilities.

Complete Automated System Solutions

Keithley’s S500 Integrated Test Systems are highly configurable, instrument-based systems for semiconductor characterization at the device, wafer, or cassette level. Built on our proven Series 2600B System SourceMeter SMU instruments, our S500 Integrated Test Systems

Table 1. Series 2600B software tools

Feature/Functionality	Keithley IVy Mobile App	Built-in Web Browser Based App	Test Script Builder (TSB)	ACS Basic Edition
Description	Quick I-V characterization tool for bench and lab users to visualize, interact and share measurement data via Android devices.	Built-in web browser based software for I-V characterization.	Custom script writing tool for TSP instruments	Semiconductor characterization software for component test, verification, and analysis
Capability	Basic	General	Advanced	High Performance
Supported Hardware	Series 2600B	Series 2600B	Series 2600B, Series 3700	Series 2400, Series 2600B, 4200-SCS
Supported Buses	Not Applicable	LAN/LXI	GPIO, RS-232, LAN/LXI, USB	GPIO, LAN/LXI
Functionality	Visualize data in time mode, two terminal I-V mode and family of curves mode. Analyze collected data interactively with smart device’s built-in capabilities. Share data instantly via mobile networks/Wi-Fi	Linear/Log Sweeps, Pulsing, Custom sweeps, Single point source-measures. Note: Uses new 2600B’s new API’s for precision timing and channel synchronization	Custom scripts with total flexibility, full featured debugger	Intuitive, wizard-based GUI, Rich set of test libraries, curve trace capability
Data Management	.csv and graphic data export	.csv export	User defined	Formulator tool with wide range of math functions
Installation	Free download from app stores	Not necessary. Embedded in the instrument.	Free Download or CD Install on PC.	Optional purchase

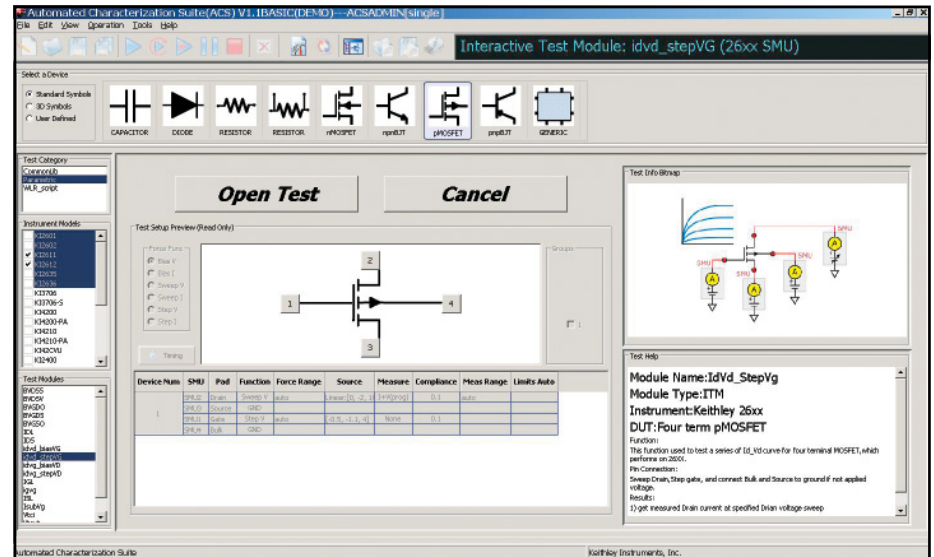

When you need to acquire data on a packaged part quickly, the wizard-based user interface of ACS Basic Edition makes it easy to find and run the test you want, like this common FET curve trace test.

provide innovative measurement features and system flexibility, scalable to your needs. The unique measurement capability, combined with the powerful and flexible Automated Characterization Suite (ACS) software, provides a comprehensive range of applications and features not offered on other comparable systems on the market.

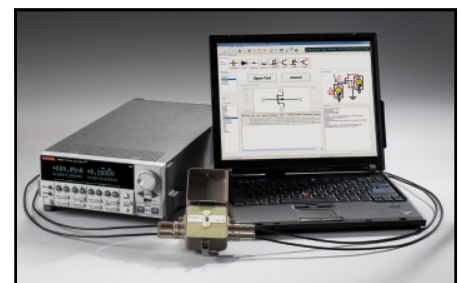

The flexible software architecture of ACS Basic Edition allows configuring systems with a wide range of controllers and test fixtures, as well as the exact number of SourceMeter SMU instruments the application requires.

1.888.KEITHLEY (U.S. only)

www.keithley.com

A Greater Measure of Confidence

KEITHLEY

A Tektronix Company

Scalable, integrated source and measure solutions

SMU INSTRUMENTS

Series 2600B

System SourceMeter® SMU Instruments

Scalable, integrated source and measure solutions

TYPICAL APPLICATIONS

I-V functional test and characterization of a wide range of devices, including:

- Discrete and passive components
 - Two-leaded – Sensors, disk drive heads, metal oxide varistors (MOVs), diodes, zener diodes, sensors, capacitors, thermistors
 - Three-leaded – Small signal bipolar junction transistors (BJTs), field-effect transistors (FETs), and more
- Simple ICs – Optos, drivers, switches, sensors, converters, regulators
- Integrated devices – small scale integrated (SSI) and large scale integrated (LSI)
 - Analog ICs
 - Radio frequency integrated circuits (RFICs)
 - Application specific integrated circuits (ASICs)
 - System on a chip (SOC) devices
- Optoelectronic devices such as light-emitting diodes (LEDs), laser diodes, high brightness LEDs (HBLEDs), vertical cavity surface-emitting lasers (VCSELs), displays
- Wafer level reliability
 - NBTI, TDD, HCI, electromigration
- Solar Cells
- Batteries
- And more...

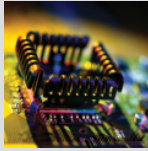

In the first and third quadrants, Series 2600B SMU instruments operate as a source, delivering power to a load. In the second and fourth quadrants, they operate as a sink, dissipating power internally.

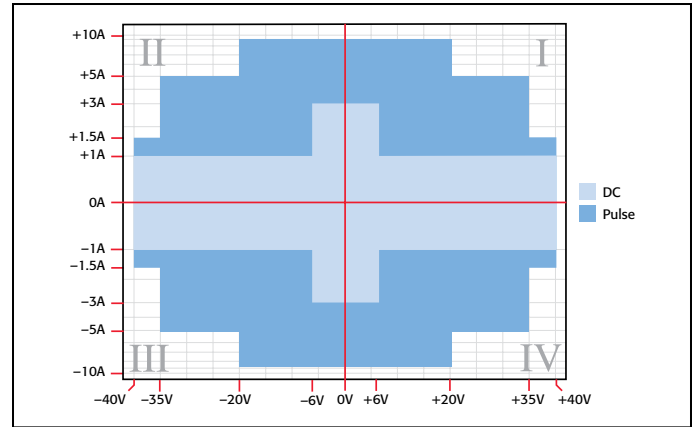

Models 2601B, 2602B, and 2604B I-V capability

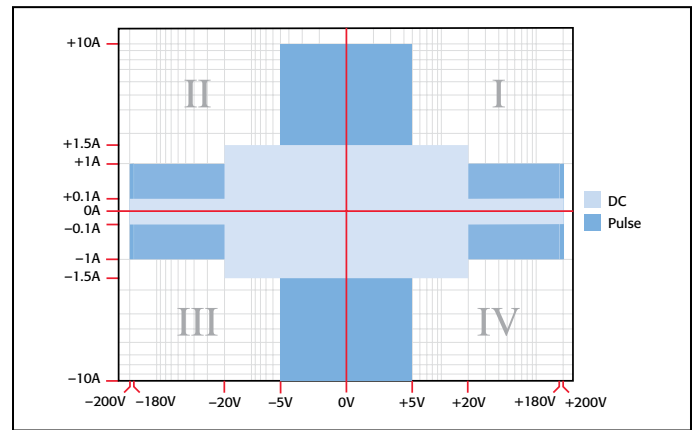

Models 2611B, 2612B, and 2614B I-V capability

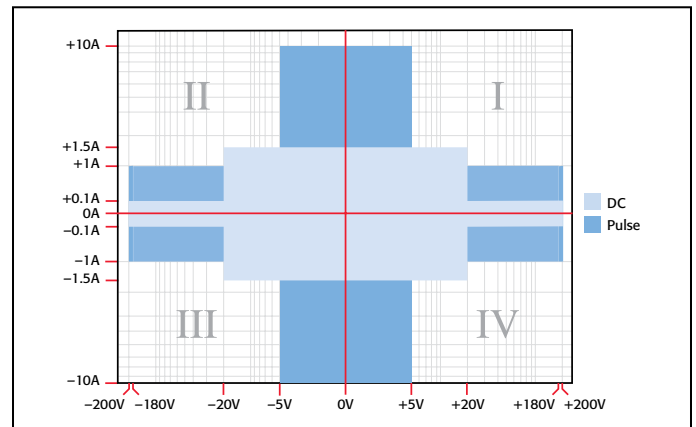

Models 2634B, 2635B, and 2636B I-V capability



Model 2604B/2614B rear panel
(Single channels 2601B, 2611B, 2635B not shown)

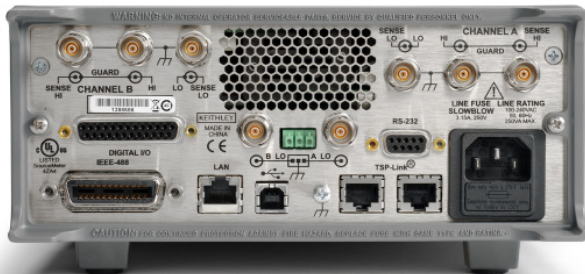

Model 2636B rear panel

1.888.KEITHLEY (U.S. only)

www.keithley.com

SMU INSTRUMENTS

SPECIFICATION CONDITIONS

This document contains specifications and supplemental information for the Models 2601B, 2602B, and 2604B System SourceMeter[®] SMU instruments. Specifications are the standards against which the Models 2601B, 2602B, and 2604B are tested. Upon leaving the factory, the 2601B, 2602B, and 2604B meet these specifications. Supplemental and typical values are non-warranted, apply at 23°C, and are provided solely as useful information.

Accuracy specifications are applicable for both normal and high capacitance modes.

The source and measurement accuracies are specified at the SourceMeter CHANNEL A (2601B, 2602B, and 2604B) or SourceMeter CHANNEL B (2602B and 2604B) terminals under the following conditions:

1. 23°C ± 5°C, <70% relative humidity
2. After 2 hour warm-up
3. Speed normal (1 NPLC)
4. A/D auto-zero enabled
5. Remote sense operation or properly zeroed local operation
6. Calibration period = 1 year

SOURCE SPECIFICATIONS

VOLTAGE SOURCE SPECIFICATIONS

VOLTAGE PROGRAMMING ACCURACY¹

Range	Programming Resolution	Accuracy (1 Year) 23°C ± 5°C ±(% rdg. + volts)	Typical Noise (peak-peak) 0.1Hz–10Hz
100 mV	5 μV	0.02% + 250 μV	20 μV
1 V	50 μV	0.02% + 400 μV	50 μV
6 V	50 μV	0.02% + 1.8 mV	100 μV
40 V	500 μV	0.02% + 12 mV	500 μV

TEMPERATURE COEFFICIENT (0°–18°C and 28°–50°C)²: ±(0.15 × accuracy specification)/°C. Applicable for normal mode only. Not applicable for high capacitance mode.

MAXIMUM OUTPUT POWER AND SOURCE/SINK LIMITS³: 40.4W per channel maximum. ±40.4V @ ±1.0A, ±6.06V @ ±3.0A, four quadrant source or sink operation.

VOLTAGE REGULATION: Line: 0.01% of range. **Load:** ±(0.01% of range + 100μV).

NOISE 10Hz–20MHz: <20mV peak-peak (typical), <5mV RMS (typical), 6V range.

CURRENT LIMIT/COMPLIANCE⁴: Bipolar current limit (compliance) set with single value. Minimum value is 10nA. Accuracy same as current source.

OVERSHOOT: ≤±(0.1% + 10mV) typical. Step size = 10% to 90% of range, resistive load, maximum current limit/compliance.

GUARD OFFSET VOLTAGE: <4mV typical. Current <10mA.

CURRENT SOURCE SPECIFICATIONS

CURRENT PROGRAMMING ACCURACY

Range	Programming Resolution	Accuracy (1 Year) 23°C ± 5°C ±(% rdg. + amps)	Typical Noise (peak-peak) 0.1Hz–10Hz
100 nA	2 pA	0.06% + 100 pA	5 pA
1 μA	20 pA	0.03% + 800 pA	25 pA
10 μA	200 pA	0.03% + 5 nA	60 pA
100 μA	2 nA	0.03% + 60 nA	3 nA
1 mA	20 nA	0.03% + 300 nA	6 nA
10 mA	200 nA	0.03% + 6 μA	200 nA
100 mA	2 μA	0.03% + 30 μA	600 nA
1 A ⁵	20 μA	0.05% + 1.8 mA	70 μA
3 A ⁵	20 μA	0.06% + 4 mA	150 μA
10 A ^{5,6}	200 μA	0.5 % + 40 mA (typical)	

TEMPERATURE COEFFICIENT (0°–18°C and 28°–50°C)⁷: ±(0.15 × accuracy specification)/°C.

MAXIMUM OUTPUT POWER AND SOURCE/SINK LIMITS⁸: 40.4W per channel maximum. ±1.01A @ ±40.0V, ±3.03A @ ±6.0V, four quadrant source or sink operation.

CURRENT REGULATION: Line: 0.01% of range. **Load:** ±(0.01% of range + 100pA).

VOLTAGE LIMIT/COMPLIANCE⁹: Bipolar voltage limit (compliance) set with a single value. Minimum value is 10mV. Accuracy is the same as voltage source.

OVERSHOOT: ≤±0.1% typical (step size = 10% to 90% of range, resistive load; see Current Source Output Settling Time for additional test conditions).

ADDITIONAL SOURCE SPECIFICATIONS

TRANSIENT RESPONSE TIME: <70μs for the output to recover to within 0.1% for a 10% to 90% step change in load.

VOLTAGE SOURCE OUTPUT SETTLING TIME: Time required to reach within 0.1% of final value after source level command is processed on a fixed range.

100mV, 1V Ranges: <50μs typical.

6V Range: <100μs typical.

40V Range¹⁰: <150μs typical.

CURRENT SOURCE OUTPUT SETTLING TIME: Time required to reach within 0.1% of final value after source level command is processed on a fixed range. Values below for $I_{out} \times R_{load} = 1V$ unless noted.

3A Range: <80μs typical (current less than 2.5A, $R_{load} > 2\Omega$).

1A–10mA Ranges: <80μs typical ($R_{load} > 6\Omega$).

1mA Range: <100μs typical.

100μA Range: <150μs typical.

10μA Range: <500μs typical.

1μA Range: <2.5ms typical.

100nA Range: <25ms typical.

DC FLOATING VOLTAGE: Output can be floated up to ±250VDC from chassis ground.

REMOTE SENSE OPERATING RANGE¹¹:

Maximum voltage between HI and SENSE HI = 3V.

Maximum voltage between LO and SENSE LO = 3V.

VOLTAGE OUTPUT HEADROOM:

40V Range: Max. output voltage = 42V – total voltage drop across source leads (maximum 1Ω per source lead).

6V Range: Max. output voltage = 8V – total voltage drop across source leads (maximum 1Ω per source lead).

OVER TEMPERATURE PROTECTION: Internally sensed temperature overload puts unit in standby mode.

VOLTAGE SOURCE RANGE CHANGE OVERSHOOT: <300mV + 0.1% of larger range (typical). Overshoot into an 100kΩ load, 20MHz BW.

CURRENT SOURCE RANGE CHANGE OVERSHOOT: <5% of larger range + 300mV/ R_{load} (typical with source settling set to SETTLE_SMOOTH_100NA). See Current Source Output Settling Time for additional test conditions.

NOTES

1. Add 50μV to source accuracy specifications per volt of HI lead drop.
2. High Capacitance Mode accuracy is applicable at 23°C ± 5°C only.
3. Full power source operation regardless of load to 30°C ambient. Above 30°C and/or power sink operation, refer to "Operating Boundaries" in the Series 2600B Reference Manual for additional power derating information.
4. For sink mode operation (quadrants II and IV), add 0.06% of limit range to the corresponding current limit accuracy specifications. Specifications apply with sink mode operation enabled.
5. Full power source operation regardless of load to 30°C ambient. Above 30°C and/or power sink operation, refer to "Operating Boundaries" in the Series 2600B Reference Manual for additional power derating information.
6. 10A range accessible only in pulse mode.
7. High Capacitance Mode accuracy is applicable at 23°C ± 5°C only.
8. Full power source operation regardless of load to 30°C ambient. Above 30°C and/or power sink operation, refer to "Operating Boundaries" in the Series 2600B Reference Manual for additional power derating information.
9. For sink mode operation (quadrants II and IV), add 10% of compliance range and ±0.02% of limit setting to corresponding voltage source specification. For 100mV range add an additional 60mV of uncertainty.
10. Add 150μs when measuring on the 1A range.
11. Add 50μV to source accuracy specifications per volt of HI lead drop.

1.888.KEITHLEY (U.S. only)

www.keithley.com

2601B, 2602B, 2604B

System SourceMeter[®] SMU Instruments

Series 2600B specifications

SMU INSTRUMENTS

SOURCE SPECIFICATIONS (continued)

PULSE SPECIFICATIONS

Region	Maximum Current Limit	Maximum Pulse Width ¹²	Maximum Duty Cycle ¹³
1	1 A @ 40 V	DC, no limit	100%
1	3 A @ 6 V	DC, no limit	100%
2	1.5 A @ 40 V	100 ms	25%
3	5 A @ 35 V	4 ms	4%
4	10 A @ 20 V	1.8 ms	1%

MINIMUM PROGRAMMABLE PULSE WIDTH^{14, 15}: 100 μ s. NOTE: Minimum pulse width for settled source at a given I/V output and load can be longer than 100 μ s.

PULSE WIDTH PROGRAMMING RESOLUTION: 1 μ s.

PULSE WIDTH PROGRAMMING ACCURACY¹⁵: $\pm 5\mu$ s.

PULSE WIDTH JITTER: 2 μ s (typical).

QUADRANT DIAGRAM:

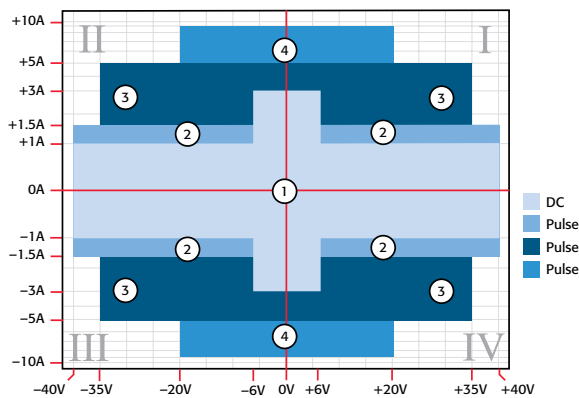

NOTES

12. Times measured from the start of pulse to the start off-time; see figure below.

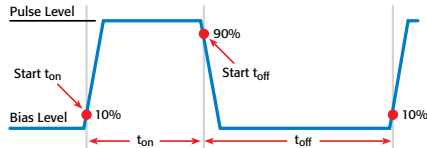

13. Thermally limited in sink mode (quadrants II and IV) and ambient temperatures above 30°C. See power equations in the reference manual for more information.

14. Typical performance for minimum settled pulse widths:

Source Value	Load	Source Settling (% of range)	Min. Pulse Width
6 V	2 Ω	0.2%	150 μ s
20 V	2 Ω	1%	200 μ s
35 V	7 Ω	0.5%	500 μ s
40 V	27 Ω	0.1%	400 μ s
1.5 A	27 Ω	0.1%	1.5 ms
3 A	2 Ω	0.2%	150 μ s
5 A	7 Ω	0.5%	500 μ s
10 A	2 Ω	0.5%	200 μ s

Typical tests were performed using remote operation, 4W sense, and best, fixed measurement range. For more information on pulse scripts, see the Series 2600B Reference Manual.

15. Times measured from the start of pulse to the start off-time; see figure below.

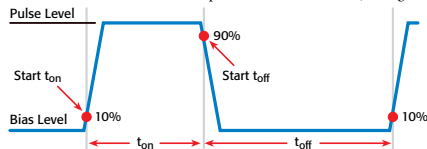

METER SPECIFICATIONS

VOLTAGE MEASUREMENT ACCURACY^{16, 17}

Range	Default Display Resolution ¹⁸	Input Resistance	Accuracy (1 Year) 23°C $\pm 5^\circ$ C \pm (% rdg. + volts)
100 mV	100 nV	>10 G Ω	0.015% + 150 μ V
1 V	1 μ V	>10 G Ω	0.015% + 200 μ V
6 V	10 μ V	>10 G Ω	0.015% + 1 mV
40 V	10 μ V	>10 G Ω	0.015% + 8 mV

TEMPERATURE COEFFICIENT (0°–18°C and 28°–50°C)¹⁹: $\pm(0.15 \times \text{accuracy specification})/^\circ\text{C}$. Applicable for normal mode only. Not applicable for high capacitance mode.

CURRENT MEASUREMENT ACCURACY¹⁷

Range	Default Display Resolution ²⁰	Voltage Burden ²¹	Accuracy (1 Year) 23°C $\pm 5^\circ$ C \pm (% rdg. + amps)
100 nA	100 fA	<1 mV	0.05% + 100 pA
1 μ A	1 pA	<1 mV	0.025% + 500 pA
10 μ A	10 pA	<1 mV	0.025% + 1.5 nA
100 μ A	100 pA	<1 mV	0.02% + 25 nA
1 mA	1 nA	<1 mV	0.02% + 200 nA
10 mA	10 nA	<1 mV	0.02% + 2.5 μ A
100 mA	100 nA	<1 mV	0.02% + 20 μ A
1 A	1 μ A	<1 mV	0.03% + 1.5 mA
3 A	1 μ A	<1 mV	0.05% + 3.5 mA
10 A ²²	10 μ A	<1 mV	0.4% + 25 mA (typical)

CURRENT MEASURE SETTLING TIME (Time for measurement to settle after a V_{step})²³: Time required to reach within 0.1% of final value after source level command is processed on a fixed range. Values for $V_{\text{out}} = 1\text{V}$ unless noted. Current Range: 1mA. Settling Time: <100 μ s (typical).

TEMPERATURE COEFFICIENT (0°–18°C and 28°–50°C)²⁴: $\pm(0.15 \times \text{accuracy specification})/^\circ\text{C}$. Applicable for normal mode only. Not applicable for high capacitance mode.

CONTACT CHECK²⁵ (not available on Model 2604B)

Speed	Maximum Measurement Time To Memory For 60Hz (50Hz)	Accuracy (1 Year) 23°C $\pm 5^\circ$ C \pm (%rdg. + ohms)
FAST	1 (1.2) ms	5% + 10 Ω
MEDIUM	4 (5) ms	5% + 1 Ω
SLOW	36 (42) ms	5% + 0.3 Ω

ADDITIONAL METER SPECIFICATIONS

MAXIMUM LOAD IMPEDANCE:

Normal Mode: 10nF (typical). High Capacitance Mode: 50 μ F (typical).

COMMON MODE VOLTAGE: 250VDC.

COMMON MODE ISOLATION: >1G Ω , <4500pF.

OVERRANGE: 101% of source range, 102% of measure range.

MAXIMUM SENSE LEAD RESISTANCE: 1k Ω for rated accuracy.

SENSE INPUT IMPEDANCE: >10G Ω .

NOTES

16. Add 50 μ V to source accuracy specifications per volt of HI lead drop.

17. De-rate accuracy specifications for NPLC setting < 1 by increasing error term.

Add appropriate % of range term using table below.

NPLC Setting	100mV Range	1V–40V Ranges	100nA Range	1 μ A–100mA Ranges	1A–3A Ranges
0.1	0.01%	0.01%	0.01%	0.01%	0.01%
0.01	0.08%	0.07%	0.1%	0.05%	0.05%
0.001	0.8 %	0.6 %	1%	0.5 %	1.1 %

18. Applies when in single channel display mode.

19. High Capacitance Mode accuracy is applicable for 23°C $\pm 5^\circ$ C only.

20. Applies when in single channel display mode.

21. Four-wire remote sense only with current meter mode selected. Voltage measure set to 100mV or 1V range only.

22. 10A range accessible only in pulse mode.

23. Compliance equal to 100mA.

24. High Capacitance Mode accuracy is applicable for 23°C $\pm 5^\circ$ C only.

25. Includes measurement of SENSE HI to HI and SENSE LO to LO contact resistances.

1.888.KEITHLEY (U.S. only)

www.keithley.com

KEITHLEY

A Greater Measure of Confidence

A Tektronix Company

2601B, 2602B, 2604B

System SourceMeter[®] SMU Instruments

HIGH CAPACITANCE MODE^{26, 27, 28}

VOLTAGE SOURCE OUTPUT SETTLING TIME: Time required to reach 0.1% of final value after source level command is processed on a fixed range. Current limit = 1A.

Voltage Source Range	Settling Time with $C_{load} = 4.7\mu F$
100 mV	200 μs (typical)
1 V	200 μs (typical)
6 V	200 μs (typical)
40 V	7 ms (typical)

CURRENT MEASURE SETTLING TIME: Time required to reach 0.1% of final value after voltage source is stabilized on a fixed range. Values below for $V_{out} = 1V$ unless noted.

Current Measure Range	Settling Time
3 A – 1 A	<120 μs (typical) ($R_{load} > 2\Omega$)
100 mA – 10 mA	<100 μs (typical)
1 mA	< 3 ms (typical)
100 μA	< 3 ms (typical)
10 μA	< 230 ms (typical)
1 μA	< 230 ms (typical)

CAPACITOR LEAKAGE PERFORMANCE USING HIGH-C SCRIPTS²⁹: Load = $5\mu F || 10M\Omega$.
Test: 5V step and measure. 200ms (typical) @ 50nA.

MODE CHANGE DELAY:

100 μA Current Range and Above:
Delay into High Capacitance Mode: 10ms.
Delay out of High Capacitance Mode: 10ms.
1 μA and 10 μA Current Ranges:
Delay into High Capacitance Mode: 230ms.
Delay out of High Capacitance Mode: 10ms.

VOLTMETER INPUT IMPEDANCE: 10G Ω in parallel with 3300pF.

NOISE, 10Hz–20MHz (6V Range): <30mV peak-peak (typical).

VOLTAGE SOURCE RANGE CHANGE OVERSHOOT: <400mV + 0.1% of larger range (typical).
Overshoot into a 100k Ω load, 20MHz BW.

NOTES

- High Capacitance Mode specifications are for DC measurements only.
- 100nA range is not available in High Capacitance Mode.
- High Capacitance Mode utilizes locked ranges. Auto Range is disabled.
- Part of KI Factory scripts. See reference manual for details.

GENERAL

IEEE-488: IEEE-488.1 compliant. Supports IEEE-488.2 common commands and status model topology.

USB CONTROL (REAR): USB 2.0 device, TMC488 protocol.

RS-232: Baud rates from 300bps to 115200bps.

ETHERNET: RJ-45 connector, LXI Class C, 10/100BT, no auto MDIX.

EXPANSION INTERFACE: The TSP-Link expansion interface allows TSP enabled instruments to trigger and communicate with each other. (Not available on Model 2604B.)

Cable Type: Category 5e or higher LAN crossover cable.

Length: 3 meters maximum between each TSP enabled instrument.

LXI COMPLIANCE: LXI Class C 1.4.

LXI TIMING: Total Output Trigger Response Time: 245 μs min., 280 μs typ., (not specified) max. Receive LAN[0-7] Event Delay: Unknown. Generate LAN[0-7] Event Delay: Unknown.

DIGITAL I/O INTERFACE: (Not available on Model 2604B)

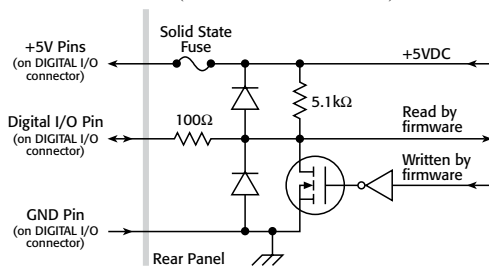

Connector: 25-pin female D.

Input/Output Pins: 14 open drain I/O bits.

Absolute Maximum Input Voltage: 5.25V.

Absolute Minimum Input Voltage: –0.25V.

Maximum Logic Low Input Voltage: 0.7V, +850 μA max.

Minimum Logic High Input Voltage: 2.1V, +570 μA .

Maximum Source Current (flowing out of Digital I/O bit): +960 μA .

Maximum Sink Current @ Maximum Logic Low Voltage (0.7V): –5.0mA.

Absolute Maximum Sink Current (flowing into Digital I/O pin): –11mA (not including Model 2604B).

5V Power Supply Pins: Limited to 250mA total for all three pins, solid state fuse protected.

Output Enable: Active high input pulled down internally to ground with a 10k Ω resistor; when the output enable input function has been activated, each SourceMeter channel will not turn on unless the output enable pin is driven to >2.1V (nominal current = 2.1V/10k Ω = 210 μA).

USB FILE SYSTEM (FRONT): USB 2.0 Host: Mass storage class device.

POWER SUPPLY: 100V to 250VAC, 50–60Hz (auto sensing), 240VA max.

COOLING: Forced air. Side intake and rear exhaust. One side must be unobstructed when rack mounted.

EMC: Conforms to European Union Directive 2004/108/EEC, EN 61326-1.

SAFETY: Conforms to European Union Directive 73/23/EEC, EN 61010-1, and UL 61010-1.

DIMENSIONS: 89mm high \times 213mm wide \times 460mm deep (3 $\frac{1}{2}$ in \times 8 $\frac{3}{8}$ in \times 17 $\frac{1}{2}$ in). Bench Configuration (with handle and feet): 104mm high \times 238mm wide \times 460mm deep (4 $\frac{1}{8}$ in \times 9 $\frac{3}{8}$ in \times 17 $\frac{1}{2}$ in).

WEIGHT: 2601B: 4.75kg (10.4 lbs). 2602B, 2604B: 5.50kg (12.0 lbs).

ENVIRONMENT: For indoor use only.

Altitude: Maximum 2000 meters above sea level.

Operating: 0°–50°C, 70% R.H. up to 35°C. Derate 3% R.H./°C, 35°–50°C.

Storage: –25°C to 65°C.

1.888.KEITHLEY (U.S. only)

www.keithley.com

A Greater Measure of Confidence

KEITHLEY

A Tektronix Company

2611B, 2612B, 2614B

System SourceMeter[®] SMU Instruments

Series 2600B specifications

SMU INSTRUMENTS

SPECIFICATION CONDITIONS

This document contains specifications and supplemental information for the Models 2611B, 2612B, and 2614B System SourceMeter[®] SMU instruments. Specifications are the standards against which the Models 2611B, 2612B, and 2614B are tested. Upon leaving the factory the 2611B, 2612B, and 2614B meet these specifications. Supplemental and typical values are non-warranted, apply at 23°C, and are provided solely as useful information.

Accuracy specifications are applicable for both normal and high capacitance modes.

The source and measurement accuracies are specified at the SourceMeter CHANNEL A (2611B, 2612B, and 2614B) or SourceMeter CHANNEL B (2612B, 2614B) terminals under the following conditions:

1. 23°C ± 5°C, <70% relative humidity.
2. After 2 hour warm-up.
3. Speed normal (1 NPLC).
4. A/D auto-zero enabled.
5. Remote sense operation or properly zeroed local sense operation.
6. Calibration period = 1 year.

SOURCE SPECIFICATIONS

VOLTAGE SOURCE SPECIFICATIONS

VOLTAGE PROGRAMMING ACCURACY¹

Range	Programming Resolution	Accuracy (1 Year) 23°C ±5°C ±(% rdg. + volts)	Typical Noise (Peak-Peak) 0.1Hz–10Hz
200 mV	5 μV	0.02% + 375 μV	20 μV
2 V	50 μV	0.02% + 600 μV	50 μV
20 V	500 μV	0.02% + 5 mV	300 μV
200 V	5 mV	0.02% + 50 mV	2 mV

TEMPERATURE COEFFICIENT (0°–18°C and 28°–50°C)²: ±(0.15 × accuracy specification)/°C. Applicable for normal mode only. Not applicable for high capacitance mode.

MAXIMUM OUTPUT POWER AND SOURCE/SINK LIMITS³: 30.3W per channel maximum. ±20.2V @ ±1.5A, ±202V @ ±100mA, four quadrant source or sink operation.

VOLTAGE REGULATION: Line: 0.01% of range. **Load**: ±(0.01% of range + 100μV).

NOISE 10Hz–20MHz: <20mV peak-peak (typical), <3mV RMS (typical), 20V range.

CURRENT LIMIT/COMPLIANCE⁴: Bipolar current limit (compliance) set with single value. Minimum value is 10nA. Accuracy is the same as current source.

OVERSHOOT: <±(0.1% + 10mV) (typical). Step size = 10% to 90% of range, resistive load, maximum current limit/compliance.

GUARD OFFSET VOLTAGE: <4mV (current <10mA).

CURRENT SOURCE SPECIFICATIONS

CURRENT PROGRAMMING ACCURACY⁵

Range	Programming Resolution	Accuracy (1 Year) 23°C ±5°C ±(% rdg. + amps)	Typical Noise (Peak-Peak) 0.1Hz–10Hz
100 nA	2 pA	0.06% + 100 pA	5 pA
1 μA	20 pA	0.03% + 800 pA	25 pA
10 μA	200 pA	0.03% + 5 nA	60 pA
100 μA	2 nA	0.03% + 60 nA	3 nA
1 mA	20 nA	0.03% + 300 nA	6 nA
10 mA	200 nA	0.03% + 6 μA	200 nA
100 mA	2 μA	0.03% + 30 μA	600 nA
1 A ⁶	20 μA	0.05% + 1.8 mA	70 μA
1.5 A ⁶	50 μA	0.06% + 4 mA	150 μA
10 A ^{6,7}	200 μA	0.5% + 40 mA (typical)	

TEMPERATURE COEFFICIENT (0°–18°C and 28°–50°C)⁸: ±(0.15 × accuracy specification)/°C. Applicable for normal mode only. Not applicable for high capacitance mode.

MAXIMUM OUTPUT POWER AND SOURCE/SINK LIMITS³: 30.3W per channel maximum. ±1.515A @ ±20V, ±101mA @ ±200V, four quadrant source or sink operation.

CURRENT REGULATION: Line: 0.01% of range. **Load**: ±(0.01% of range + 100pA).

VOLTAGE LIMIT/COMPLIANCE¹⁰: Bipolar voltage limit (compliance) set with a single value. Minimum value is 20mV. Accuracy is the same as voltage source.

OVERSHOOT: <±0.1% (typical). Step size = 10% to 90% of range, resistive load; see Current Source Output Settling Time for additional test conditions.

ADDITIONAL SOURCE SPECIFICATIONS

TRANSIENT RESPONSE TIME: <70μs for the output to recover to within 0.1% for a 10% to 90% step change in load.

VOLTAGE SOURCE OUTPUT SETTLING TIME: Time required to within reach 0.1% of final value after source level command is processed on a fixed range.

Range	Settling Time
200 mV	<50 μs (typical)
2 V	<50 μs (typical)
20 V	<110 μs (typical)
200 V	<700 μs (typical)

CURRENT SOURCE OUTPUT SETTLING TIME: Time required to reach within 0.1% of final value after source level command is processed on a fixed range. Values below for $I_{out} \cdot R_{load} = 2V$ unless noted.

Current Range	Settling Time
1.5 A – 1 A	<120 μs (typical) ($R_{load} > 6\Omega$)
100 mA – 10 mA	<80 μs (typical)
1 mA	<100 μs (typical)
100 μA	<150 μs (typical)
10 μA	<500 μs (typical)
1 μA	<2 ms (typical)
100 nA	<20 ms (typical)

DC FLOATING VOLTAGE: Output can be floated up to ±250VDC from chassis ground.

REMOTE SENSE OPERATING RANGE¹¹: Maximum voltage between HI and SENSE HI = 3V.
Maximum voltage between LO and SENSE LO = 3V.

VOLTAGE OUTPUT HEADROOM:

200V Range: Max. output voltage = 202.3V – total voltage drop across source leads (maximum 1Ω per source lead).

20V Range: Max. output voltage = 23.3V – total voltage drop across source leads (maximum 1Ω per source lead).

OVER TEMPERATURE PROTECTION: Internally sensed temperature overload puts unit in standby mode.

VOLTAGE SOURCE RANGE CHANGE OVERSHOOT: <300mV + 0.1% of larger range (typical). Overshoot into a 200kΩ load, 20MHz BW.

CURRENT SOURCE RANGE CHANGE OVERSHOOT: <5% of larger range + 300mV/ R_{load} (typical – With source settling set to SETTLE_SMOOTH_100NA). See Current Source Output Settling Time for additional test conditions.

NOTES

1. Add 50μV to source accuracy specifications per volt of HI lead drop.
2. High Capacitance Mode accuracy is applicable at 23°C ±5°C only.
3. Full power source operation regardless of load to 30°C ambient. Above 30°C and/or power sink operation, refer to "Operating Boundaries" in the Series 2600B Reference Manual for additional power derating information.
4. For sink mode operation (quadrants II and IV), add 0.06% of limit range to the corresponding current limit accuracy specifications. Specifications apply with sink mode operation enabled.
5. Accuracy specifications do not include connector leakage. Derate accuracy by $V_{out}/2E11$ per °C when operating between 18°–28°C. Derate accuracy by $V_{out}/2E11 + (0.15V_{out}/2E11)$ per °C when operating <18°C and >28°C.
6. Full power source operation regardless of load to 30°C ambient. Above 30°C and/or power sink operation, refer to "Operating Boundaries" in the Series 2600B Reference Manual for additional power derating information.
7. 10A range accessible only in pulse mode.
8. High Capacitance Mode accuracy is applicable at 23°C ±5°C only.
9. Full power source operation regardless of load to 30°C ambient. Above 30°C and/or power sink operation, refer to "Operating Boundaries" in the Series 2600B Reference Manual for additional power derating information.
10. For sink mode operation (quadrants II and IV), add 10% of compliance range and ±0.02% of limit setting to corresponding voltage source specification. For 200mV range add an additional 120mV of uncertainty.
11. Add 50μV to source accuracy specifications per volt of HI lead drop.

PULSE SPECIFICATIONS

Region	Maximum Current Limit	Maximum Pulse Width ¹²	Maximum Duty Cycle ¹³
1	100 mA @ 200 V	DC, no limit	100%
1	1.5 A @ 20 V	DC, no limit	100%
2	1 A @ 180 V	8.5 ms	1%
3 ¹⁴	1 A @ 200 V	2.2 ms	1%
4	10 A @ 5 V	1 ms	2.2%

MINIMUM PROGRAMMABLE PULSE WIDTH^{15, 16}: 100μs. NOTE: Minimum pulse width for settled source at a given I/V output and load can be longer than 100μs.

PULSE WIDTH PROGRAMMING RESOLUTION: 1μs.

PULSE WIDTH PROGRAMMING ACCURACY¹⁶: ±5μs.

PULSE WIDTH JITTER: 2μs (typical).

1.888.KEITHLEY (U.S. only)

www.keithley.com

KEITHLEY

A Greater Measure of Confidence

A Tektronix Company

2611B, 2612B, 2614B

System SourceMeter[®] SMU Instruments

SOURCE SPECIFICATIONS (continued)

PULSE SPECIFICATIONS (continued)

QUADRANT DIAGRAM:

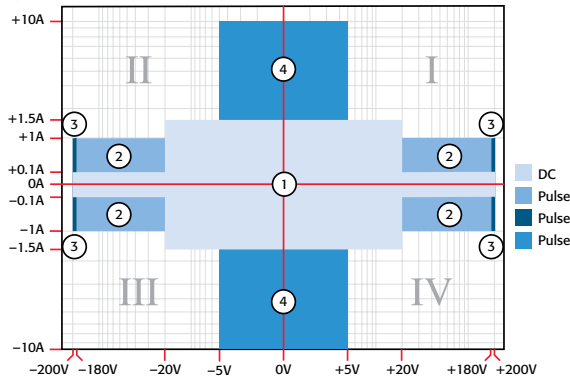

NOTES

12. Times measured from the start of pulse to the start off-time; see figure below.

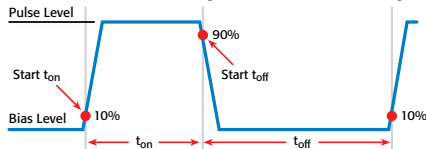

13. Thermally limited in sink mode (quadrants II and IV) and ambient temperatures above 30°C. See power equations in the reference manual for more information.

14. Voltage source operation with 1.5 A current limit.

15. Typical performance for minimum settled pulse widths:

Source Value	Load	Source Settling (% of range)	Min. Pulse Width
5 V	0.5 Ω	1%	300 μs
20 V	200 Ω	0.2%	200 μs
180 V	180 Ω	0.2%	5 ms
200 V (1.5 A Limit)	200 Ω	0.2%	1.5 ms
100 mA	200 Ω	1%	200 μs
1 A	200 Ω	1%	500 μs
1 A	180 Ω	0.2%	5 ms
10 A	0.5 Ω	0.5%	300 μs

Typical tests were performed using remote operation, 4W sense, and best, fixed measurement range. For more information on pulse scripts, see the Series 2600B Reference Manual.

16. Times measured from the start of pulse to the start off-time; see figure below.

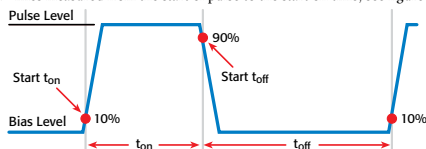

METER SPECIFICATIONS

VOLTAGE MEASUREMENT ACCURACY^{17, 18}

Range	Default Display Resolution ¹⁹	Input Resistance	Accuracy (1 Year) 23°C ±5°C ±(% rdg. + volts)
200 mV	100 nV	>10 GΩ	0.015% + 225 μV
2 V	1 μV	>10 GΩ	0.02% + 350 μV
20 V	10 μV	>10 GΩ	0.015% + 5 mV
200 V	100 μV	>10 GΩ	0.015% + 50 mV

TEMPERATURE COEFFICIENT (0°–18°C and 28°–50°C)²⁰: ±(0.15 × accuracy specification)/°C. Applicable for normal mode only. Not applicable for high capacitance mode.

CURRENT MEASUREMENT ACCURACY^{18, 21}

Range	Default Display Resolution ²²	Voltage Burden ²³	Accuracy (1 Year) 23°C ±5°C ±(% rdg. + amps)
100 nA	100 fA	<1 mV	0.06% + 100 pA
1 μA	1 pA	<1 mV	0.025% + 500 pA
10 μA	10 pA	<1 mV	0.025% + 1.5 nA
100 μA	100 pA	<1 mV	0.02% + 25 nA
1 mA	1 nA	<1 mV	0.02% + 200 nA
10 mA	10 nA	<1 mV	0.02% + 2.5 μA
100 mA	100 nA	<1 mV	0.02% + 20 μA
1 A	1 μA	<1 mV	0.03% + 1.5 mA
1.5 A	1 μA	<1 mV	0.05% + 3.5 mA
10 A ²⁴	10 μA	<1 mV	0.4% + 25 mA (typical)

CURRENT MEASURE SETTLING TIME (Time for measurement to settle after a Vstep)²⁵: Time required to reach 0.1% of final value after source level command is processed on a fixed range. Values for $V_{out} = 2V$ unless noted. Current Range: 1mA. Settling Time: <100μs (typical).

TEMPERATURE COEFFICIENT (0°–18°C and 28°–50°C)²⁶: ±(0.15 × accuracy specification)/°C. Applicable for normal mode only. Not applicable for high capacitance mode.

CONTACT CHECK²⁷ (not available on Model 2614B)

Speed	Maximum Measurement Time to Memory For 60Hz (50Hz)	Accuracy (1 Year) 23°C ±5°C ±(%rdg. + ohms)
FAST	1 (1.2) ms	5% + 10 Ω
MEDIUM	4 (5) ms	5% + 1 Ω
SLOW	36 (42) ms	5% + 0.3 Ω

ADDITIONAL METER SPECIFICATIONS

MAXIMUM LOAD IMPEDANCE:

Normal Mode: 10nF (typical). High Capacitance Mode: 50μF (typical).

COMMON MODE VOLTAGE: 250VDC.

COMMON MODE ISOLATION: >1GΩ, <4500pF.

OVERRANGE: 101% of source range, 102% of measure range.

MAXIMUM SENSE LEAD RESISTANCE: 1kΩ for rated accuracy.

SENSE INPUT IMPEDANCE: >10GΩ.

1.888.KEITHLEY (U.S. only)

www.keithley.com

A Greater Measure of Confidence

KEITHLEY

A Tektronix Company

2611B, 2612B, 2614B

System SourceMeter[®] SMU Instruments

METER SPECIFICATIONS (continued)

NOTES

17. Add 50 μ V to source accuracy specifications per volt of HI lead drop.
 18. De-rate accuracy specifications for NPLC setting <1 by increasing error term. Add appropriate % of range term using table below.
- | NPLC Setting | 200mV Range | 2V–200V Ranges | 100nA Range | 1 μ A–100mA Ranges | 1A–1.5A Ranges |
|--------------|-------------|----------------|-------------|------------------------|----------------|
| 0.1 | 0.01% | 0.01% | 0.01% | 0.01% | 0.01% |
| 0.01 | 0.08% | 0.07% | 0.1% | 0.05% | 0.05% |
| 0.001 | 0.8% | 0.6% | 1% | 0.5% | 1.1% |
19. Applies when in single channel display mode.
 20. High Capacitance Mode accuracy is applicable at 23°C \pm 5°C only.
 21. Accuracy specifications do not include connector leakage. De-rate accuracy by $V_{out}/2E11$ per °C when operating between 18°–28°C. Derate accuracy by $V_{out}/2E11 + (0.15 * V_{out}/2E11)$ per °C when operating <18° and >28°C.
 22. Applies when in single channel display mode.
 23. Four-wire remote sense only and with current meter mode selected. Voltage measure set to 200mV or 2V range only.
 24. 10A range accessible only in pulse mode.
 25. Compliance equal to 100mA.
 26. High Capacitance Mode accuracy is applicable at 23°C \pm 5°C only.
 27. Includes measurement of SENSE HI to HI and SENSE LO to LO contact resistances.

HIGH CAPACITANCE MODE 28, 29, 30

VOLTAGE SOURCE OUTPUT SETTLING TIME: Time required to reach within 0.1% of final value after source level command is processed on a fixed range. Current limit = 1A.

Voltage Source Range	Settling Time with $C_{load} = 4.7\mu$ F
200 mV	600 μ s (typical)
2 V	600 μ s (typical)
20 V	1.5 ms (typical)
200 V	20 ms (typical)

CURRENT MEASURE SETTLING TIME: Time required to reach within 0.1% of final value after voltage source is stabilized on a fixed range. Values below for $V_{out} = 2V$ unless noted.

Current Measure Range	Settling Time
1.5 A – 1 A	<120 μ s (typical) ($R_{load} > 6\Omega$)
100 mA – 10 mA	<100 μ s (typical)
1 mA	< 3 ms (typical)
100 μ A	< 3 ms (typical)
10 μ A	< 230 ms (typical)
1 μ A	< 230 ms (typical)

CAPACITOR LEAKAGE PERFORMANCE USING HIGH-C SCRIPTS³¹: Load = 5 μ F || 10M Ω .

Test: 5V step and measure. 200ms (typical) @ 50nA.

MODE CHANGE DELAY:

100 μ A Current Range and Above:

- Delay into High Capacitance Mode: 10ms.
- Delay out of High Capacitance Mode: 10ms.

1 μ A and 10 μ A Current Ranges:

- Delay into High Capacitance Mode: 230ms.
- Delay out of High Capacitance Mode: 10ms.

VOLTMETER INPUT IMPEDANCE: 30G Ω in parallel with 330pF.

NOISE, 10Hz–20MHz (20V Range): <30mV peak-peak (typical).

VOLTAGE SOURCE RANGE CHANGE OVERTHOOT (for 20V range and below): <400mV + 0.1% of larger range (typical). Overshoot into a 200k Ω load, 20MHz BW.

NOTES

28. High Capacitance Mode specifications are for DC measurements only.
29. 100nA range is not available in High Capacitance Mode.
30. High Capacitance Mode utilizes locked ranges. Auto Range is disabled.
31. Part of KI Factory scripts, See reference manual for details.

GENERAL

IEEE-488: IEEE-488.1 compliant. Supports IEEE-488.2 common commands and status model topology.

USB CONTROL (REAR): USB 2.0 device, TMC488 protocol.

RS-232: Baud rates from 300bps to 115200bps.

ETHERNET: RJ-45 connector, LXI Class C, 10/100BT, no auto MDIX.

EXPANSION INTERFACE: The TSP-Link expansion interface allows TSP enabled instruments to trigger and communicate with each other. (Not available on Model 2614B.)

Cable Type: Category 5e or higher LAN crossover cable.

Length: 3 meters maximum between each TSP enabled instrument.

LXI COMPLIANCE: LXI Class C 1.4.

LXI TIMING: Total Output Trigger Response Time: 245 μ s min., 280 μ s typ., (not specified) max. **Receive LAN[0-7] Event Delay:** Unknown. **Generate LAN[0-7] Event Delay:** Unknown.

DIGITAL I/O INTERFACE: (Not available on Model 2614B)

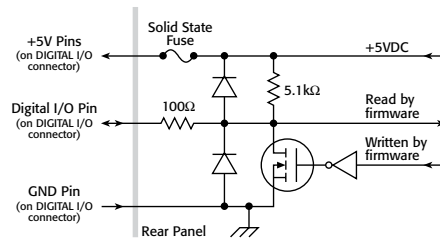

Connector: 25-pin female D.

Input/Output Pins: 14 open drain I/O bits.

Absolute Maximum Input Voltage: 5.25V.

Absolute Minimum Input Voltage: –0.25V.

Maximum Logic Low Input Voltage: 0.7V, +850 μ A max.

Minimum Logic High Input Voltage: 2.1V, +570 μ A.

Maximum Source Current (flowing out of Digital I/O bit): +960 μ A.

Maximum Sink Current @ Maximum Logic Low Voltage (0.7V): –5.0mA.

Absolute Maximum Sink Current (flowing into Digital I/O pin): –11mA.

5V Power Supply Pins: Limited to 250mA total for all three pins, solid state fuse protected.

Safety Interlock Pin: Active high input. >3.4V @ 24mA (absolute maximum of 6V) must be externally applied to this pin to ensure 200V operation. This signal is pulled down to chassis ground with a 10k Ω resistor. 200V operation will be blocked when the INTERLOCK signal is <0.4V (absolute minimum –0.4V). See figure below:

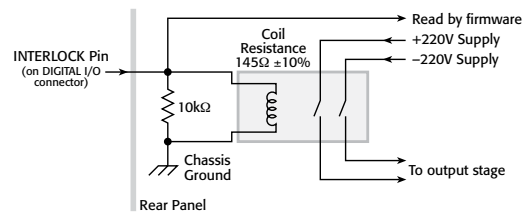

USB FILE SYSTEM (FRONT): USB 2.0 Host: Mass storage class device.

POWER SUPPLY: 100V to 250VAC, 50–60Hz (auto sensing), 240VA max.

COOLING: Forced air. Side intake and rear exhaust. One side must be unobstructed when rack mounted.

EMC: Conforms to European Union Directive 2004/108/EEC, EN 61326-1.

SAFETY: Conforms to European Union Directive 73/23/EEC, EN 61010-1, and UL 61010-1.

DIMENSIONS: 89mm high \times 213mm wide \times 460mm deep (3 $\frac{1}{2}$ in \times 8 $\frac{3}{8}$ in \times 17 $\frac{1}{2}$ in). Bench Configuration (with handle and feet): 104mm high \times 238mm wide \times 460mm deep (4 $\frac{1}{8}$ in \times 9 $\frac{3}{8}$ in \times 17 $\frac{1}{2}$ in).

WEIGHT: 2611B: 4.75kg (10.4 lbs). 2612B, 2614B: 5.50kg (12.0 lbs).

ENVIRONMENT: For indoor use only. **Altitude:** Maximum 2000 meters above sea level.

Operating: 0°–50°C, 70% R.H. up to 35°C. Derate 3% R.H./°C, 35°–50°C.

Storage: –25°C to 65°C.

1.888.KEITHLEY (U.S. only)

www.keithley.com

KEITHLEY

A Greater Measure of Confidence

A Tektronix Company

2634B, 2635B, 2636B

System SourceMeter® SMU Instruments

SPECIFICATION CONDITIONS

This document contains specifications and supplemental information for the Models 2634B, 2635B, and 2636B System SourceMeter® SMU instruments. Specifications are the standards against which the Models 2634B, 2635B, and 2636B are tested. Upon leaving the factory the 2634B, 2635B, and 2636B meet these specifications. Supplemental and typical values are non-warranted, apply at 23°C, and are provided solely as useful information.

Accuracy specifications are applicable for both normal and high capacitance modes.

The source and measurement accuracies are specified at the SourceMeter CHANNEL A (2634B, 2635B, and 2636B) or SourceMeter CHANNEL B (2634B, 2636B) terminals under the following conditions:

1. 23°C ± 5°C, <70% relative humidity.
2. After 2 hour warm-up
3. Speed normal (1 NPLC)
4. A/D auto-zero enabled
5. Remote sense operation or properly zeroed local sense operation
6. Calibration period = 1 year

SOURCE SPECIFICATIONS

VOLTAGE SOURCE SPECIFICATIONS

VOLTAGE PROGRAMMING ACCURACY¹

Range	Programming Resolution	Accuracy (1 Year) 23°C ± 5°C ±(% rdg. + volts)	Typical Noise (peak-peak) 0.1Hz–10Hz
200 mV	5 μV	0.02% + 375 μV	20 μV
2 V	50 μV	0.02% + 600 μV	50 μV
20 V	500 μV	0.02% + 5 mV	300 μV
200 V	5 mV	0.02% + 50 mV	2 mV

TEMPERATURE COEFFICIENT (0°–18°C and 28°–50°C)²: ±(0.15 × accuracy specification)/°C. Applicable for normal mode only. Not applicable for high capacitance mode.

MAXIMUM OUTPUT POWER AND SOURCE/SINK LIMITS³: 30.3W per channel maximum. ±20.2V @ ±1.5A, ±202V @ ±100mA, four quadrant source or sink operation.

VOLTAGE REGULATION: Line: 0.01% of range. Load: ±(0.01% of range + 100μV).

NOISE 10Hz–20MHz: <20mV pk-pk (typical), <3mV rms (typical), 20V range.

CURRENT LIMIT/COMPLIANCE⁴: Bipolar current limit (compliance) set with single value. Minimum value is 100pA. Accuracy is the same as current source.

OVERSHOOT: <±(0.1% + 10mV) typical (step size = 10% to 90% of range, resistive load, maximum current limit/compliance).

GUARD OFFSET VOLTAGE: <4mV (current <10mA).

CURRENT SOURCE SPECIFICATIONS

CURRENT PROGRAMMING ACCURACY

Range	Programming Resolution	Accuracy (1 Year) 23°C ± 5°C ±(% rdg. + amps)	Typical Noise (peak-peak) 0.1Hz–10Hz
1 nA	20 fA	0.15% + 2 pA	800 fA
10 nA	200 fA	0.15% + 5 pA	2 pA
100 nA	2 pA	0.06% + 50 pA	5 pA
1 μA	20 pA	0.03% + 700 pA	25 pA
10 μA	200 pA	0.03% + 5 nA	60 pA
100 μA	2 nA	0.03% + 60 nA	3 nA
1 mA	20 nA	0.03% + 300 nA	6 nA
10 mA	200 nA	0.03% + 6 μA	200 nA
100 mA	2 μA	0.03% + 30 μA	600 nA
1 A ⁵	20 μA	0.05% + 1.8 mA	70 μA
1.5 A ⁵	50 μA	0.06% + 4 mA	150 μA
10 A ^{5,6}	200 μA	0.5 % + 40 mA (typical)	

TEMPERATURE COEFFICIENT (0°–18°C and 28°–50°C)⁷: ±(0.15 × accuracy specification)/°C. Applicable for normal mode only. Not applicable for high capacitance mode.

MAXIMUM OUTPUT POWER AND SOURCE/SINK LIMITS⁸: 30.3W per channel maximum. ±1.51A @ ±20V, ±101mA @ ±200V, four quadrant source or sink operation.

CURRENT REGULATION: Line: 0.01% of range. Load: ±(0.01% of range + 100pA).

VOLTAGE LIMIT/COMPLIANCE⁹: Bipolar voltage limit (compliance) set with a single value. Minimum value is 20mV. Accuracy is the same as voltage source.

OVERSHOOT: <±0.1% typical (step size = 10% to 90% of range, resistive load, maximum current limit/compliance; see Current Source Output Settling Time for additional test conditions).

ADDITIONAL SOURCE SPECIFICATIONS

TRANSIENT RESPONSE TIME: <70μs for the output to recover to within 0.1% for a 10% to 90% step change in load.

VOLTAGE SOURCE OUTPUT SETTLING TIME: Time required to reach within 0.1% of final value after source level command is processed on a fixed range.

Range	Settling Time
200 mV	<50 μs (typical)
2 V	<50 μs (typical)
20 V	<110 μs (typical)
200 V	<700 μs (typical)

CURRENT SOURCE OUTPUT SETTLING TIME: Time required to reach within 0.1% of final value after source level command is processed on a fixed range. Values below for I_{out} · R_{load} = 2V unless noted.

Current Range	Settling Time
1.5 A – 1 A	<120 μs (typical) (R _{load} > 6Ω)
100 mA – 10 mA	<80 μs (typical)
1 mA	<100 μs (typical)
100 μA	<150 μs (typical)
10 μA	<500 μs (typical)
1 μA	<2 ms (typical)
100 nA	<20 ms (typical)
10 nA	<40 ms (typical)
1 nA	<150 ms (typical)

DC FLOATING VOLTAGE: Output can be floated up to ±250VDC.

REMOTE SENSE OPERATING RANGE¹⁰: Maximum voltage between HI and SENSE HI = 3V. Maximum voltage between LO and SENSE LO = 3V.

VOLTAGE OUTPUT HEADROOM:

200V Range: Max. output voltage = 202.3V – total voltage drop across source leads (maximum 1Ω per source lead).

20V Range: Max. output voltage = 23.3V – total voltage drop across source leads (maximum 1Ω per source lead).

OVER TEMPERATURE PROTECTION: Internally sensed temperature overload puts unit in standby mode.

VOLTAGE SOURCE RANGE CHANGE OVERSHOOT: <300mV + 0.1% of larger range (typical). Overshoot into a 200kΩ load, 20MHz BW.

CURRENT SOURCE RANGE CHANGE OVERSHOOT: <5% of larger range + 300mV/R_{load} (typical – With source settling set to SETTLE_SMOOTH_100NA). See Current Source Output Settling Time for additional test conditions.

PULSE SPECIFICATIONS

Region	Maximum Current Limit	Maximum Pulse Width ¹¹	Maximum Duty Cycle ¹²
1	100 mA @ 200 V	DC, no limit	100%
1	1.5 A @ 20 V	DC, no limit	100%
2	1 A @ 180 V	8.5 ms	1%
3 ¹³	1 A @ 200 V	2.2 ms	1%
4	10 A @ 5 V	1 ms	2.2%

MINIMUM PROGRAMMABLE PULSE WIDTH^{14, 15}: 100μs. NOTE: Minimum pulse width for settled source at a given I/V output and load can be longer than 100μs.

PULSE WIDTH PROGRAMMING RESOLUTION: 1μs.

PULSE WIDTH PROGRAMMING ACCURACY¹⁵: ±5μs.

PULSE WIDTH JITTER: 50μs (typical).

QUADRANT DIAGRAM:

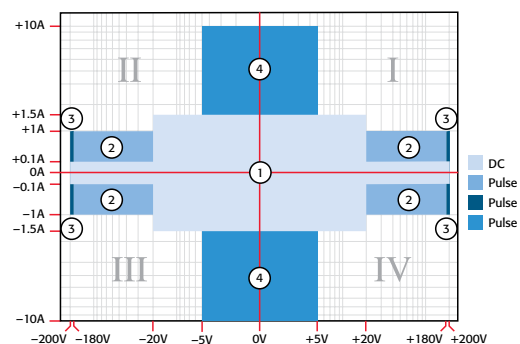

1.888.KEITHLEY (U.S. only)

www.keithley.com

A Greater Measure of Confidence

KEITHLEY
A Tektronix Company

2634B, 2635B, 2636B

System SourceMeter[®] SMU Instruments

SOURCE SPECIFICATIONS (continued)

NOTES

- Add 50 μ V to source accuracy specifications per volt of HI lead drop.
- High Capacitance Mode accuracy is applicable at 23°C \pm 5°C only.
- Full power source operation regardless of load to 30°C ambient. Above 30°C and/or power sink operation, refer to "Operating Boundaries" in the Series 2600B Reference Manual for additional power derating information.
- For sink mode operation (quadrants II and IV), add 0.06% of limit range to the corresponding current limit accuracy specifications. Specifications apply with sink mode operation enabled.
- Full power source operation regardless of load to 30°C ambient. Above 30°C and/or power sink operation, refer to "Operating Boundaries" in the Series 2600B Reference Manual for additional power derating information.
- 10A range accessible only in pulse mode.
- High Capacitance Mode accuracy is applicable at 23°C \pm 5°C only.
- Full power source operation regardless of load to 30°C ambient. Above 30°C and/or power sink operation, refer to "Operating Boundaries" in the Series 2600B Reference Manual for additional power derating information.
- For sink mode operation (quadrants II and IV), add 10% of compliance range and \pm 0.02% of limit setting to corresponding voltage source specification. For 200mV range add an additional 120mV of uncertainty.
- Add 50 μ V to source accuracy specifications per volt of HI lead drop.
- Times measured from the start of pulse to the start off-time; see figure below.

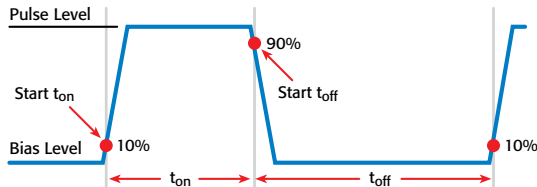

- Thermally limited in sink mode (quadrants II and IV) and ambient temperatures above 30°C. See power equations in the Reference Manual for more information.
- Voltage source operation with 1.5 A current limit.
- Typical performance for minimum settled pulse widths:

Source Value	Load	Source Settling (% of range)	Min. Pulse Width
5 V	0.5 Ω	1%	300 μ s
20 V	200 Ω	0.2%	200 μ s
180 V	180 Ω	0.2%	5 ms
200 V (1.5 A Limit)	200 Ω	0.2%	1.5 ms
100 mA	200 Ω	1%	200 μ s
1 A	200 Ω	1%	500 μ s
1 A	180 Ω	0.2%	5 ms
10 A	0.5 Ω	0.5%	300 μ s

Typical tests were performed using remote operation, 4W sense, and best, fixed measurement range. For more information on pulse scripts, see the Series 2600B Reference Manual.

- Times measured from the start of pulse to the start off-time; see figure below.

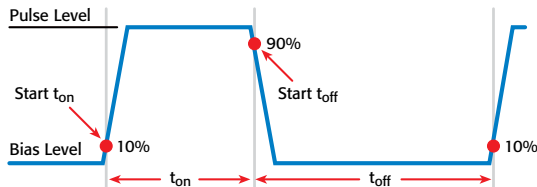

METER SPECIFICATIONS

VOLTAGE MEASUREMENT ACCURACY^{16, 17}

Range	Default Display Resolution ¹⁸	Input Resistance	Accuracy (1 Year) 23°C \pm 5°C \pm (% rdg. + volts)
200 mV	100 nV	>10 ¹⁴ Ω	0.015% + 225 μ V
2 V	1 μ V	>10 ¹⁴ Ω	0.02% + 350 μ V
20 V	10 μ V	>10 ¹⁴ Ω	0.015% + 5 mV
200 V	100 μ V	>10 ¹⁴ Ω	0.015% + 50 mV

TEMPERATURE COEFFICIENT (0°–18°C and 28°–50°C)¹⁹: \pm (0.15 \times accuracy specification)/°C. Applicable for normal mode only. Not applicable for high capacitance mode.

CURRENT MEASUREMENT ACCURACY¹⁷

Range	Default Display Resolution ²⁰	Voltage Burden ²¹	Accuracy (1 Year) 23°C \pm 5°C \pm (% rdg. + amps)
*100 pA ^{22, 23}	0.1 fA	<1 mV	0.15% + 120 fA
1 nA ^{22, 24}	1 fA	<1 mV	0.15% + 240 fA
10 nA	10 fA	<1 mV	0.15% + 3 pA
100 nA	100 fA	<1 mV	0.06% + 40 pA
1 μ A	1 pA	<1 mV	0.025% + 400 pA
10 μ A	10 pA	<1 mV	0.025% + 1.5 nA
100 μ A	100 pA	<1 mV	0.02% + 25 nA
1 mA	1 nA	<1 mV	0.02% + 200 nA
10 mA	10 nA	<1 mV	0.02% + 2.5 μ A
100 mA	100 nA	<1 mV	0.02% + 20 μ A
1 A	1 μ A	<1 mV	0.03% + 1.5 mA
1.5 A	1 μ A	<1 mV	0.05% + 3.5 mA
10 A ²⁵	10 μ A	<1 mV	0.4% + 25 mA

* 100 pA range not available on Model 2634B.

CURRENT MEASURE SETTLING TIME (Time for measurement to settle after a Vstep)²⁶: Time required to reach within 0.1% of final value after source level command is processed on a fixed range. Values for V_{out} = 2V unless noted. **Current Range:** 1mA. **Settling Time:** <100 μ s (typical).

TEMPERATURE COEFFICIENT (0°–18°C and 28°–50°C)²⁷: \pm (0.15 \times accuracy specification)/°C. Applicable for normal mode only. Not applicable for high capacitance mode.

CONTACT CHECK²⁸ (Not available on Model 2634B)

Speed	Maximum Measurement Time to Memory For 60Hz (50Hz)	Accuracy (1 Year) 23°C \pm 5°C \pm (%rdg. + ohms)
FAST	1 (1.2) ms	5% + 10 Ω
MEDIUM	4 (5) ms	5% + 1 Ω
SLOW	36 (42) ms	5% + 0.3 Ω

ADDITIONAL METER SPECIFICATIONS

MAXIMUM LOAD IMPEDANCE:

Normal Mode: 10nF (typical). High Capacitance Mode: 50 μ F (typical).

COMMON MODE VOLTAGE: 250VDC.

COMMON MODE ISOLATION: >1G Ω , <4500pF.

OVERRANGE: 101% of source range, 102% of measure range.

MAXIMUM SENSE LEAD RESISTANCE: 1k Ω for rated accuracy.

SENSE INPUT IMPEDANCE: >10¹⁴ Ω .

1.888.KEITHLEY (U.S. only)

www.keithley.com

KEITHLEY

A Tektronix Company

A Greater Measure of Confidence

2634B, 2635B, 2636B

System SourceMeter[®] SMU Instruments

METER SPECIFICATIONS (continued)

NOTES

16. Add 50µV to accuracy specifications per volt of HI lead drop.
17. De-rate accuracy specifications for NPLC setting <1 by increasing error term. Add appropriate % of range term using table below.

NPLC Setting	200mV Range	2V–200V Ranges	100nA Range	1µA–100mA Ranges	1A–1.5A Ranges
0.1	0.01%	0.01%	0.01%	0.01%	0.01%
0.01	0.08%	0.07%	0.1%	0.05%	0.05%
0.001	0.8 %	0.6 %	1%	0.5 %	1.1 %

18. Applies when in single channel display mode.
19. High Capacitance Mode accuracy is applicable at 23°C ±5°C only.
20. Applies when in single channel display mode.
21. Four-wire remote sense only and with current meter mode selected. Voltage measure set to 200mV or 2V range only.
22. 10-NPLC, 11-Point Median Filter, <200V range, measurements made within 1 hour after zeroing. 23°C ± 1°C
23. Under default specification conditions: ±(0.15% + 750fA).
24. Under default specification conditions: ±(0.15% + 1pA).
25. 10A range accessible only in pulse mode.
26. Delay factor set to 1. Compliance equal to 100mA.
27. High Capacitance Mode accuracy is applicable at 23°C ±5°C only.
28. Includes measurement of SENSE HI to HI and SENSE LO to LO contact resistances.

HIGH CAPACITANCE MODE 29, 30, 31

VOLTAGE SOURCE OUTPUT SETTLING TIME: Time required to reach within 0.1% of final value after source level command is processed on a fixed range. Current limit = 1A.

Voltage Source Range	Settling Time with $C_{load} = 4.7\mu F$
200 mV	600 µs (typical)
2 V	600 µs (typical)
20 V	1.5 ms (typical)
200 V	20 ms (typical)

CURRENT MEASURE SETTLING TIME: Time required to reach within 0.1% of final value after voltage source is stabilized on a fixed range. Values below for $V_{out} = 2V$ unless noted.

Current Measure Range	Settling Time
1.5 A – 1 A	<120 µs (typical) ($R_{load} > 6\Omega$)
100 mA – 10 mA	<100 µs (typical)
1 mA	< 3 ms (typical)
100 µA	< 3 ms (typical)
10 µA	< 230 ms (typical)
1 µA	< 230 ms (typical)

CAPACITOR LEAKAGE PERFORMANCE USING HIGH-C SCRIPTS³²: Load = 5µF || 10MΩ.
Test: 5V step and measure. 200ms (typical) @ 50nA.

MODE CHANGE DELAY:

- 100µA Current Range and Above:**
 Delay into High Capacitance Mode: 10ms.
 Delay out of High Capacitance Mode: 10ms.
- 1µA and 10µA Current Ranges:**
 Delay into High Capacitance Mode: 230ms.
 Delay out of High Capacitance Mode: 10ms.

VOLTMETER INPUT IMPEDANCE: 30GΩ in parallel with 3300pF.

NOISE, 10Hz–20MHz (20V Range): <30mV peak-peak (typical).

VOLTAGE SOURCE RANGE CHANGE OVERSHOOT (for 20V range and below): <400mV + 0.1% of larger range (typical). Overshoot into a 200kΩ load, 20MHz BW.

NOTES

29. High Capacitance Mode specifications are for DC measurements only.
30. 100nA range and below are not available in high capacitance mode.
31. High Capacitance Mode utilizes locked ranges. Auto Range is disabled.
32. Part of KI Factory scripts. See reference manual for details.

SEE PAGES 14 AND 15 FOR MEASUREMENT SPEEDS AND OTHER SPECIFICATIONS.

1.888.KEITHLEY (U.S. only)

www.keithley.com

GENERAL

IEEE-488: IEEE-488.1 compliant. Supports IEEE-488.2 common commands and status model topology.

USB CONTROL (REAR): USB 2.0 device, TMC488 protocol.

RS-232: Baud rates from 300bps to 115200bps. Programmable number of data bits, parity type, and flow control (RTS/CTS hardware or none).

ETHERNET: RJ-45 connector, LXI Class C, 10/100BT, no auto MDIX.

EXPANSION INTERFACE: The TSP-Link expansion interface allows TSP enabled instruments to trigger and communicate with each other. (Not available on Model 2614B.)

Cable Type: Category 5e or higher LAN crossover cable.

Length: 3 meters maximum between each TSP enabled instrument.

LXI COMPLIANCE: LXI Class C 1.4.

LXI TIMING: Total Output Trigger Response Time: 245µs min., 280µs typ., (not specified) max. Receive LAN[0-7] Event Delay: Unknown. Generate LAN[0-7] Event Delay: Unknown.

DIGITAL I/O INTERFACE: (Not available on Model 2614B)

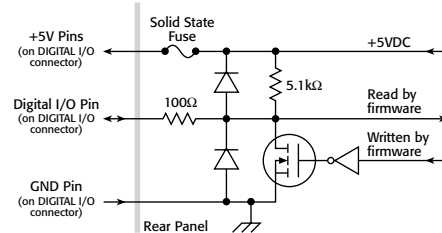

Connector: 25-pin female D.

Input/Output Pins: 14 open drain I/O bits.

Absolute Maximum Input Voltage: 5.25V.

Absolute Minimum Input Voltage: –0.25V.

Maximum Logic Low Input Voltage: 0.7V, +850µA max.

Minimum Logic High Input Voltage: 2.1V, +570µA.

Maximum Source Current (flowing out of Digital I/O bit): +960µA.

Maximum Sink Current @ Maximum Logic Low Voltage (0.7V): –5.0mA.

Absolute Maximum Sink Current (flowing into Digital I/O pin): –11mA.

5V Power Supply Pins: Limited to 250mA total for all three pins, solid state fuse protected.

Safety Interlock Pin: Active high input. >3.4V @ 24mA (absolute maximum of 6V) must be externally applied to this pin to ensure 200V operation. This signal is pulled down to chassis ground with a 10kΩ resistor. 200V operation will be blocked when the INTERLOCK signal is <0.4V (absolute minimum –0.4V). See figure below:

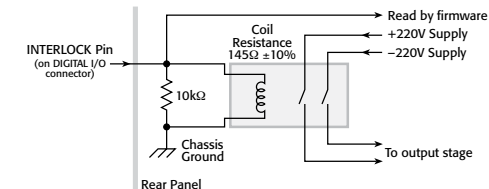

USB FILE SYSTEM (FRONT): USB 2.0 Host: Mass storage class device.

POWER SUPPLY: 100V to 250VAC, 50–60Hz (auto sensing), 240VA max.

COOLING: Forced air. Side intake and rear exhaust. One side must be unobstructed when rack mounted.

EMC: Conforms to European Union Directive 2004/108/EEC, EN 61326-1.

SAFETY: Conforms to European Union Directive 73/23/EEC, EN 61010-1, and UL 61010-1.

DIMENSIONS: 89mm high × 213mm wide × 460mm deep (3½ in × 8¾ in × 17½ in). Bench Configuration (with handle and feet): 104mm high × 238mm wide × 460mm deep (4¼ in × 9¾ in × 17½ in).

WEIGHT: 2635B: 4.75kg (10.4 lbs). 2634B, 2636B: 5.50kg (12.0 lbs).

ENVIRONMENT: For indoor use only. **Altitude:** Maximum 2000 meters above sea level.

Operating: 0°–50°C, 70% R.H. up to 35°C. Derate 3% R.H./°C, 35°–50°C.

Storage: –25°C to 65°C.

Applicable to Models 2601B, 2602B, 2604B, 2611B, 2612B, 2614B, 2634B, 2635B, and 2636B.

MEASUREMENT SPEED SPECIFICATIONS ^{1, 2, 3}

MAXIMUM SWEEP OPERATION RATES (operations per second) FOR 60Hz (50Hz):

A/D Converter Speed	Trigger Origin	Measure To Memory Using User Scripts	Measure To GPIB Using User Scripts	Source Measure To Memory Using User Scripts	Source Measure To GPIB Using User Scripts	Source Measure To Memory Using Sweep API	Source Measure To GPIB Using Sweep API
0.001 NPLC	Internal	20000 (20000)	10500 (10500)	7000 (7000)	6200 (6200)	12000 (12000)	5900 (5900)
0.001 NPLC	Digital I/O	8100 (8100)	7100 (7100)	5500 (5500)	5100 (5100)	11200 (11200)	5700 (5700)
0.01 NPLC	Internal	5000 (4000)	4000 (3500)	3400 (3000)	3200 (2900)	4200 (3700)	3100 (2800)
0.01 NPLC	Digital I/O	3650 (3200)	3400 (3000)	3000 (2700)	2900 (2600)	4150 (3650)	3050 (2775)
0.1 NPLC	Internal	580 (490)	560 (475)	550 (465)	550 (460)	575 (480)	545 (460)
0.1 NPLC	Digital I/O	560 (470)	450 (460)	545 (460)	540 (450)	570 (480)	545 (460)
1.0 NPLC	Internal	59 (49)	59 (49)	59 (49)	59 (49)	59 (49)	59 (49)
1.0 NPLC	Digital I/O	58 (48)	58 (49)	59 (49)	59 (49)	59 (49)	59 (49)

MAXIMUM SINGLE MEASUREMENT RATES (operations per second) FOR 60Hz (50Hz):

A/D Converter Speed	Trigger Origin	Measure To GPIB	Source Measure To GPIB	Source Measure Pass/Fail To GPIB
0.001 NPLC	Internal	1900 (1800)	1400 (1400)	1400 (1400)
0.01 NPLC	Internal	1450 (1400)	1200 (1100)	1100 (1100)
0.1 NPLC	Internal	450 (390)	425 (370)	425 (375)
1.0 NPLC	Internal	58 (48)	57 (48)	57 (48)

TRIGGERING AND SYNCHRONIZATION SPECIFICATIONS ¹

TRIGGERING:

- Trigger in to trigger out: 0.5 μ s, typical.
- Trigger in to source change:² 10 μ s, typical.
- Trigger Timer accuracy: \pm 2 μ s, typical.
- Source change³ after LXI Trigger: 280 μ s, typical.

SYNCHRONIZATION:

- Single-node synchronized source change:⁴ <0.5 μ s, typical.
- Multi-node synchronized source change:⁴ <0.5 μ s, typical.

NOTES

- TSP-Link not available on Models 2604B, 2614B, and 2634B.
- Fixed source range, with no polarity change.

MAXIMUM MEASUREMENT RANGE CHANGE RATE: <150 μ s for ranges >10 μ A, typical. When changing to or from a range \geq 1A, maximum rate is <450 μ s, typical.

MAXIMUM SOURCE RANGE CHANGE RATE: <2.5ms for ranges >10 μ A, typical. When changing to or from a range \geq 1A, maximum rate is <5.2ms, typical.

MAXIMUM SOURCE FUNCTION CHANGE RATE: <1ms, typical.

COMMAND PROCESSING TIME: Maximum time required for the output to begin to change following the receipt of the smux.source.level or smux.source.level command. <1ms typical.

NOTES

- Tests performed with a 2602B, 2612B, or 2636B on Channel A using the following equipment: PC Hardware (Pentium® 4 2.4GHz, 512MB RAM, National Instruments PCI-GPIB). Driver (NI-486.2 Version 2.2 PCI-GPIB). Software (Microsoft® Windows® 2000, Microsoft Visual Studio 2005, VISA version 4.1).
- Exclude current measurement ranges less than 1mA.
- 2635B/2636B with default measurement delays and filters disabled.

Applicable to Models 2601B, 2602B, 2604B, 2611B, 2612B, 2614B, 2634B, 2635B, and 2636B.

SUPPLEMENTAL INFORMATION

FRONT PANEL INTERFACE: Two-line vacuum fluorescent display (VFD) with keypad and rotary knob.

Display:

- Show error messages and user defined messages
- Display source and limit settings
- Show current and voltage measurements
- View measurements stored in dedicated reading buffers

Keypad Operations:

- Change host interface settings
- Save and restore instrument setups
- Load and run factory and user defined test scripts (i.e. sequences) that prompt for input and send results to the display
- Store measurements into dedicated reading buffers

PROGRAMMING: Embedded Test Script Processor (TSP) accessible from any host interface. Responds to individual instrument control commands. Responds to high speed test scripts comprised of instrument control commands and Test Script Language (TSL) statements (e.g. branching, looping, math, etc.). Able to execute high speed test scripts stored in memory without host intervention.

Minimum Memory Available: 16MB (approximately 250,000 lines of TSL code).

Test Script Builder: Integrated development environment for building, running, and managing TSP scripts. Includes an instrument console for communicating with any TSP enabled instrument in an interactive manner. Requires:

- VISA (NI-VISA included on CD) Pentium III 800MHz or faster personal computer
- Microsoft .NET Framework (included on CD) Microsoft Windows 98, NT, 2000, or XP
- Keithley I/O Layer (included on CD)

Software Interface: TSP Express (embedded), Direct GPIB/VISA, READ/WRITE for VB, VC/C++, LabVIEW, LabWindows/CVI, etc.

READING BUFFERS: Dedicated storage area(s) reserved for measurement data. Reading buffers are arrays of measurement elements. Each element can hold the following items:

- Measurement Source setting (at the time the measurement was taken)
- Measurement status Range information
- Timestamp

Two reading buffers are reserved for each SourceMeter channel. Reading buffers can be filled using the front panel STORE key and retrieved using the RECALL key or host interface.

Buffer Size, with timestamp and source setting: >60,000 samples.

Buffer Size, without timestamp and source setting: >140,000 samples.

Accuracy: ±100ppm.

SYSTEM EXPANSION: The TSP-Link expansion interface allows TSP enabled instruments to trigger and communicate with each other. Not applicable for Models 2604B, 2614B, and 2634B. See figure below:

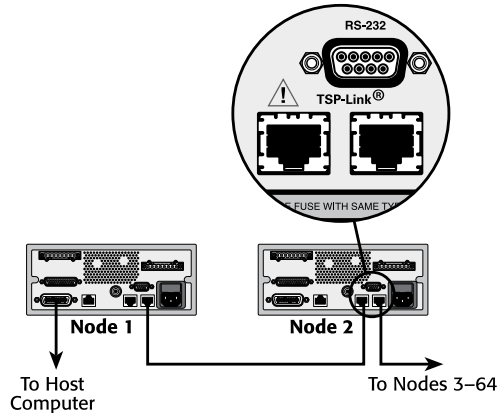

Each SourceMeter SMU instrument has two TSP-Link connectors to facilitate chaining instruments together.

Once SourceMeter SMU instruments are interconnected via TSP-Link, a computer can access all of the resources of each SourceMeter SMU instrument via the host interface of any SourceMeter SMU instrument.

A maximum of 32 TSP-Link nodes can be interconnected. Each SourceMeter SMU instrument consumes one TSP-Link node.

TIMER: Free running 47-bit counter with 1MHz clock input. Reset each time instrument powers up. Rolls over every 4 years.

Timestamp: TIMER value automatically saved when each measurement is triggered.

Resolution: 1µs.

ACCESSORIES AVAILABLE

SOFTWARE

ACS-BASIC Component Characterization Software

RACK MOUNT KITS

- 4299-1 Single Rack Mount Kit with front and rear support
- 4299-2 Dual Rack Mount Kit with front and rear support
- 4299-5 1U Vent Panel

CABLES AND CONNECTORS

- 2600-BAN Banana Test Leads/Adapter Cable. For a single 2601B/2602B/2604B/2611B/2612B/2614B SMU instrument channel
- 2600-KIT Extra screw terminal connector, strain relief, and cover for a single SourceMeter channel (one supplied with 2601B/2611B, two with 2602B/2604B/2612B/2614B)
- 2600-FIX-TRIAX Phoenix-to-Triax Adapter for 2 wire sensing
- 2600-TRIAX Phoenix-to-Triax Adapter for 4 wire sensing
- 7078-TRX* 3-Slot, Low Noise Triax Cable, 0.3m–6.1m. For use with 2600-TRIAX Adapter
- 7078-TRX-GND 3-Slot male triax to BNC adapter (guard removed)
- 7709-308A Digital I/O Connector (model specific)
- 8606 High Performance Modular Probe Kit. For use with 2600B-BAN

GPIB INTERFACES AND CABLES

- 7007-1 Double Shielded GPIB Cable, 1m (3.3 ft.)
- 7007-2 Double Shielded GPIB Cable, 2m (6.6 ft.)
- KPCI-488LPA IEEE-488 Interface/Controller for the PCI Bus

DIGITAL I/O, TRIGGER LINK, AND TSP-LINK

- 2600-TLINK Digital I/O to TLINK Adapter Cable, 1m
- CA-126-1A Digital I/O and Trigger Cable, 1.5m
- CA-180-3A CAT5 Crossover Cable for TSP-Link and direct Ethernet connection (two supplied)

TEST FIXTURES

- 8101-PIV DC, Pulse I-V and C-V Component Test Fixture
- 8101-4TRX 4 Pin Transistor Fixture
- LR8028 Component Test Fixture – Optimized for device testing at up to 200V/1A

SWITCHING

- Series 3700A DMM/Switch Systems
- 707B Semiconductor Switching Matrix Mainframe

CALIBRATION AND VERIFICATION

- 2600-STD-RES Calibration Standard 1GΩ Resistor for Models 2634B, 2635B, and 2636B

SERVICES AVAILABLE FOR ALL SERIES 2600B MODELS

EXTENDED WARRANTIES

- 26xxxB-EW 1 Year Factory Warranty extended to 2 years
- 26xxxB-3Y-EW 1 Year Factory Warranty extended to 3 years
- 26xxxB-5Y-EW 1 Year Factory Warranty extended to 5 years

CALIBRATION CONTRACTS

- C/26xxxB-3Y-STD 3 Calibrations within 3 years
- C/26xxxB-5Y-STD 5 Calibrations within 5 years
- C/26xxxB-3Y-DATA 3 Calibrations within 3 years and includes calibration data before and after adjustment
- C/26xxxB-5Y-DATA 5 Calibrations within 5 years and includes calibration data before and after adjustment
- C/26xxxB-3Y-17025 3 ISO-17025 accredited calibrations within 3 years
- C/26xxxB-5Y-17025 5 ISO-17025 accredited calibrations within 5 years

1.888.KEITHLEY (U.S. only)

www.keithley.com

Данный компонент на территории Российской Федерации

Вы можете приобрести в компании MosChip.

Для оперативного оформления запроса Вам необходимо перейти по данной ссылке:

<http://moschip.ru/get-element>

Вы можете разместить у нас заказ для любого Вашего проекта, будь то серийное производство или разработка единичного прибора.

В нашем ассортименте представлены ведущие мировые производители активных и пассивных электронных компонентов.

Нашей специализацией является поставка электронной компонентной базы двойного назначения, продукции таких производителей как XILINX, Intel (ex.ALTERA), Vicor, Microchip, Texas Instruments, Analog Devices, Mini-Circuits, Amphenol, Glenair.

Сотрудничество с глобальными дистрибьюторами электронных компонентов, предоставляет возможность заказывать и получать с международных складов практически любой перечень компонентов в оптимальные для Вас сроки.

На всех этапах разработки и производства наши партнеры могут получить квалифицированную поддержку опытных инженеров.

Система менеджмента качества компании отвечает требованиям в соответствии с ГОСТ Р ИСО 9001, ГОСТ РВ 0015-002 и ЭС РД 009

Офис по работе с юридическими лицами:

105318, г.Москва, ул.Щербаковская д.3, офис 1107, 1118, ДЦ «Щербаковский»

Телефон: +7 495 668-12-70 (многоканальный)

Факс: +7 495 668-12-70 (доб.304)

E-mail: info@moschip.ru

Skype отдела продаж:

moschip.ru

moschip.ru_4

moschip.ru_6

moschip.ru_9